



DMS Local  
For Display Management  
User Manual



## Disclaimer

BenQ Corporation makes no representations or warranties, either expressed or implied, with respect to the contents of this document. BenQ Corporation reserves the right to revise this publication and to make changes from time to time in the contents thereof without obligation to notify any person of such revision or changes.

## Copyright

Copyright 2019 BenQ Corporation. All rights reserved. No part of this publication may be reproduced, transmitted, transcribed, stored in a retrieval system or translated into any language or computer language, in any form or by any means, electronic, mechanical, magnetic, optical, chemical, manual or otherwise, without the prior written permission of BenQ Corporation.

# Table of Contents

<b>Introduction .....</b>	<b>5</b>
System requirements .....	5
<b>Initial Setup .....</b>	<b>6</b>
Connecting the display(s) and computer to a network .....	6
Installing DMS Local .....	6
<b>Using DMS Local .....</b>	<b>7</b>
Launching DMS Local for the First Time .....	7
Closing DMS Local .....	9
The DMS Local Main Page .....	10
Adding Displays to DMS Local .....	11
Managing Your Displays .....	14
Creating Groups .....	15
Renaming a Display .....	16
Deleting a Display .....	16
Device Tree Icons .....	17
Status Icons .....	17
Monitoring Your Displays .....	18
The Device Panel .....	18
The Information Tab .....	20
Controlling Your Displays .....	22
The Control Tab (Single BenQ Display) .....	23
The Control Tab (Multiple Displays) .....	24
Quick Settings .....	25
Direct Command Controls .....	26
Scheduling a Task for Your Displays .....	29
Editing a Scheduled Task .....	30
Setting a Login Password for DMS Local .....	31
Other Functions .....	32
Export Display Listings .....	32
Backup Display Listings .....	32
<b>About DMS Local .....</b>	<b>33</b>

**Troubleshooting ..... 34**  
**Appendix: About DMS Cloud..... 35**



# Introduction

DMS Local is a software tool for computers that enables remote and centralized management of multiple displays by IT administrators/technicians via a local network. DMS Local's management capabilities include the ability to remotely monitor, control, and configure displays individually or as groups.

DMS Local is designed for use in settings where multiple displays are spread out across various spaces and for convenience sake require a central portal to manage and monitor each display remotely, for example a multi-floored office building or a school with multiple classrooms.

## System requirements

To install and run DMS Local, a computer must meet the following minimum hardware and software requirements.

<b>CPU</b>	Intel i7 2.6GHz
<b>Free memory</b>	8 GB
<b>Hard disk space</b>	2GB
<b>Connectivity</b>	<ul style="list-style-type: none"> <li>• Wi-Fi capability</li> <li>• RJ-45 Ethernet port</li> </ul>
<b>Display Resolution</b>	1054x640 or higher  It is suggested that the resolution for your computer's is set to 1054x640 or higher with a standard size/ratio to ensure the best visualization of the DMS Local interface.
<b>Operating system</b>	<ul style="list-style-type: none"> <li>• Windows 7 (32/64-bit)</li> <li>• Windows 10</li> </ul>
<b>Other</b>	For certain functions within DMS Local the following requirements may need to be met: <ul style="list-style-type: none"> <li>• Internet access</li> <li>• A Gmail, Yahoo Mail, or Outlook Mail Service account</li> </ul>  Mail accounts must be configured to allow less secure sign-ins for full functionality in DMS Local. For Gmail accounts you can configure this setting in the <b>Google Account &gt; Apps with account access &gt; Allow less secure apps</b> menu. For other mail services this setting should be located in the security settings menu for the service.

For a display to support management via DMS Local the display must feature the following items:

- An RJ-45 Ethernet port with LAN control functionality

## Initial Setup

Before you can properly use DMS Local to manage your display(s) the following setup procedures must be completed:

- Connect the displays and computer to the same network
- Install DMS Local on your computer
- Configure display settings

### Connecting the display(s) and computer to a network

To connect the displays and computer to the same network, follow the steps below:

1. Connect the displays to an Ethernet LAN or WAN network via a hub, switch or router using RJ-45 cables.
2. Connect the computer to the same network using either an RJ-45 cable or via a wireless connection.

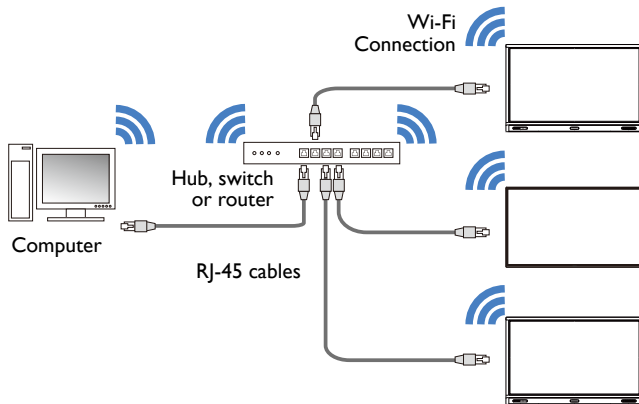

- For details on the location of ports and connectors, please refer to the documentations for the computer and displays.
- It is suggested that you connect your computer to the network using a RJ-45 cable to ensure a stable connection.

### Installing DMS Local

To install DMS Local on your computer, first ensure that the computer meets the minimum system requirements described on [System requirements](#), then follow the steps below:



- To avoid improper functioning for DMS Local, it is suggested that only one computer in the shared network install and run DMS Local. Multiple computers simultaneously running DMS Local will prevent DMS Local from functioning properly.

1. Download the DMS Local software from the following URL: <https://business-display.benq.com/en/findproduct/itp/software/device-management-solution/download.html> or <https://business-display.benq.com/en/findproduct/signage/software/device-management-solution/download.html>.
2. Launch the installation file and follow the on-screen instructions to complete the installation.

# Using DMS Local

## Launching DMS Local for the First Time

Once you have completed the steps described in [Initial Setup](#), you can launch DMS Local in one of the following ways:

- Click the Windows **Start** button and then select **Programs > DMSLocal > DMSLocal**.
- Double-click the **DMSLocal** icon on the Windows desktop.

After launching DMS Local for the first time you will be prompted to enter an activation code before you can begin using the software. To obtain the activation code follow the steps below:



Before you can begin to activate DMS Local, you must first connect your computer to the Internet.

1. Apply for a license using one of the following methods:

- Click the **Apply activation code** link at the bottom of the **Activate BenQ DMS Local** prompt. Your computer will open the **Get the license here** webpage that will allow you to apply for a license and obtain the activation code.

- Open the BenQ Display Solutions website (<https://business-display.benq.com/en/index.html>), click the **Find Product > Software** link at the top of the page, then click the **DOWNLOAD** link in the **Device Management Solution** box, and then click the **GET LICENSE KEY** link in the **DMSLocal** box.

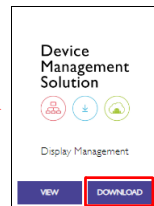
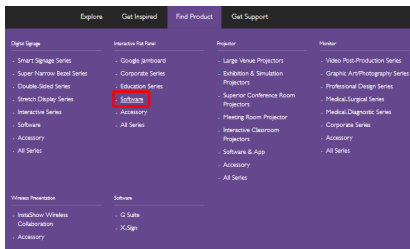

2. In the **Get the license here** webpage enter the following information in their respective fields and then click **Send**.
  - a. **Serial Number** - Enter the 13-character serial number located on the chassis of the display you want to control using DMS Local.
  - b. **e-Mail** - Enter your company or organization's e-mail address where you want the registration code to be sent.
  - c. **Industrial Classification** - Select the industry for your company/organization.

- d. **Company Name** - Enter your company or organization's name.
- e. **Verification Code** - Enter the 4-digit code shown in the window colored box.

3. When all the required information for the **Get the license here** webpage is entered and submitted, a verification e-mail will be sent to the e-mail address entered in the **e-Mail** field. Open your e-mail inbox and click the **Confirm** link in the verification e-mail to verify your e-mail address.

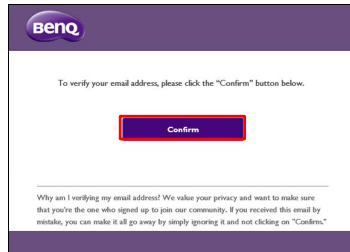

- If the serial number entered in the **Get the license here** page has been previously used to obtain an activation code via an e-mail address different from the one entered, a prompt will appear notifying you of this. You can then choose to change the e-mail address for the specified serial number and re-obtain the activation code using the new e-mail address.
- If you have previously verified the e-mail address entered in the **Get the license here** page, the activation code will be directly sent to the e-mail address.
- If you have not received a verification e-mail shortly after submitting the information in the **Get the license here** page click the **Resend me a verification email again** button in the license application submission page.



- Once your e-mail address has been verified, the activation code will be sent to your e-mail address listed in the **Key** field.



- Return to the **Activate BenQ DMS Local** window and enter the activation code shown in the **Key** field, and then click the **Activate** button.

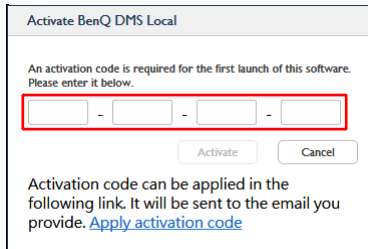



Once you have activated DMS Local and begin using DMS Local for the first time, it is suggested that you update DMS Local's database of displays to ensure that DMS Local features the most up-to-date information available on BenQ's cloud service site. For more information on updating DMS Local's database of displays refer to the instructions on [page 11](#).

## Closing DMS Local

When you are finished using DMS Local, closing the program window alone does not properly close DMS Local, you must fully exit the program to ensure that DMS Local is properly closed. To exit DMS Local follow the instructions below:

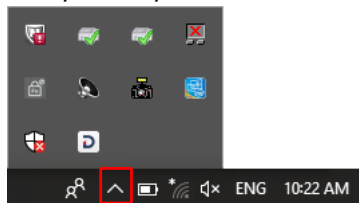
- Click  in the Windows system tray.



- Right-click the DMS Local icon  and select **Exit**.

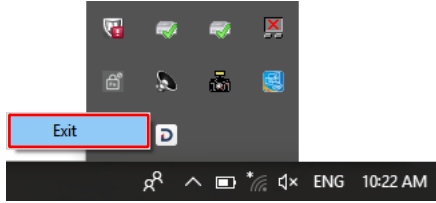





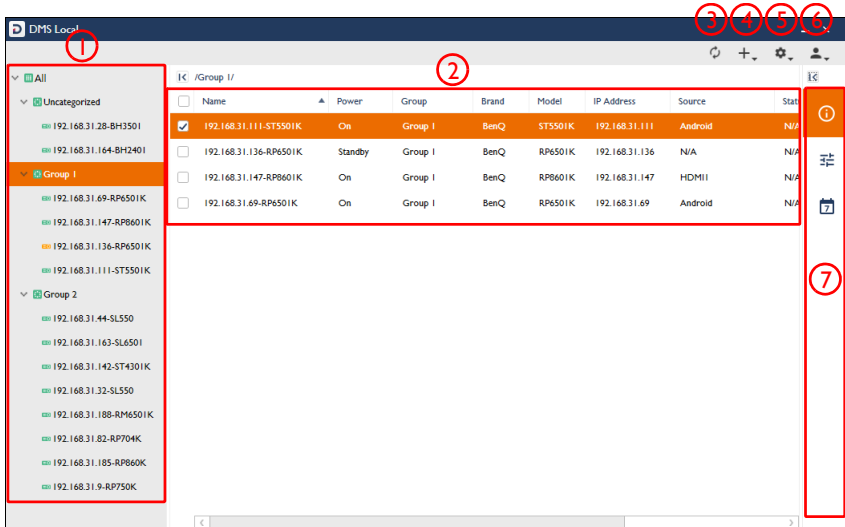



## The DMS Local Main Page

The main page for DMS Local will be shown. The following items are featured on the DMS Local main page.



No.	Item	Description
1	Device Tree	Shows all the displays and display groups managed by DMS Local in a tree-view structure. See <a href="#">Adding Displays to DMS Local</a> for more information on the adding displays to the device tree. See <a href="#">Device Tree Icons</a> for more information on the status icons shown in the device tree.
2	Device Panel	Shows status information for the display(s) or display groups selected in the device tree. See <a href="#">The Device Panel</a> for more information on the various fields featured in the device panel.

No.	Item	Description
3	Refresh 	<p>Click to refresh the status of the displays shown on the main page.</p> <p> DMS Local will automatically refresh the display status after a given interval of time. The refresh button is to allow users to get the most up-to-date information at any given time.</p>
4	Add 	<p>Click to search for and add displays to the DMS Local management system, or to create groups for better organization in the device tree.</p> <p>See <a href="#">Adding Displays to DMS Local</a> for more information on adding displays and display groups.</p>
5	Settings 	<p>Click to access various system management functions for administrators, such as error reports, e-mail alerts, database backups, and more.</p> <p>See <a href="#">Other Functions</a> for more information on the system management functions available for the Settings button.</p>
6	User 	<p>Click to setup a login password for DMS Local.</p> <p>See <a href="#">Setting a Login Password for DMS Local</a> for more information on setting up a login password.</p>
7	Action Panel	<p>Provides various tools that allow you to further manage/monitor displays and display groups, including the information tab (), control tab (), and the schedule tab (.</p> <p>See <a href="#">The Information Tab</a>, <a href="#">Controlling Your Displays</a>, or <a href="#">Scheduling a Task for Your Displays</a> for more information on each tab in the Action Panel.</p> <p> The action panel only appears when a display or display group is selected in the device panel. The information tab only appears when a single display is selected in the device panel.</p>

## Adding Displays to DMS Local

In order to manage a display via the DMS Local software the display must first be added into the DMS Local device tree.

Before adding any displays, it is suggested that you first update DMS Local's database of displays to ensure that DMS Local features the most up-to-date information regarding newly added displays, including their product names and available configurations. To update DMS Local's display database, follow the steps below:

1. Ensure that the computer running DMS Local is connected to the Internet.

- Click the Settings button  and then select **Update device definitions (JSON)**.

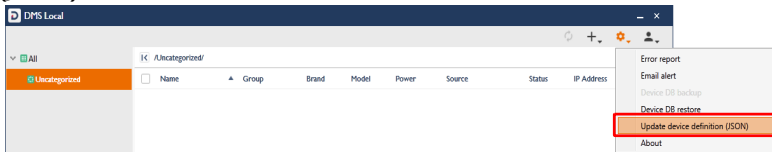

- Once the prompt notifying you that the device definitions have been updated appears, restart DMS Local and begin adding displays.

To add display(s) to DMS Local follow the steps below:



Before following the steps below, ensure that your computer and displays are connected to the same network, as described in [Connecting the display\(s\) and computer to a network](#).

- Click the add button () and then select **Add new device**.

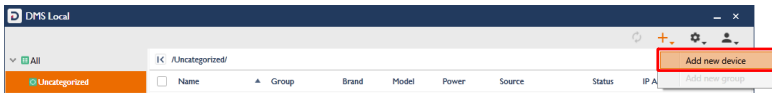

- In **Add new device** pop-up window choose one of the following options:
  - In the **Network Interface** field select the interface your computer is using to connect to the network, and then click **Scan**.

Add new device

Please select the network interface connected to the target device network for scanning.

Network interface

Realtek PCIe FE Family Controller - [192.168.1.103]

Search specific IP range

~



The network interface can be either your computer's network card (for wired connections) or its wireless card (for wireless connections).

- Check the **Search specific IP range** box, enter the IP range set for the displays in the network by the IT administrator, and then click **Scan**.

**Add new device**

Please select the network interface connected to the target device network for scanning.

Network Interface  
Realtek PCIe FE Family Controller - [192.168.1.103]

Search specific IP range

~

Scan Cancel



To obtain the IP range for the displays on your network, consult your IT administrator.

3. After DMS Local is finished scanning, a list of displays that are connected to your network will appear. In the displays list you can choose from the following options:

**Add new device**

Select device(s) to be added

Checked device(s) will be added. Modify Name/Description fields if needed.

<input type="checkbox"/>	IP Address	Model	Name	Description	Identify
<input type="checkbox"/>	192.168.31.111	ST5501K	192.168.31.111-ST5501K		9
<input type="checkbox"/>	192.168.31.116	RM7502K	192.168.31.116-RM7502K		7
<input type="checkbox"/>	192.168.31.164	BH2401	192.168.31.164-BH2401		6
<input type="checkbox"/>	192.168.31.185	RP860K	192.168.31.185-RP860K		2
<input type="checkbox"/>	192.168.31.188	RM6501K	192.168.31.188-RM6501K		8
<input type="checkbox"/>	192.168.31.28	BH3501	192.168.31.28-BH3501		1

Back Add Cancel

- a. Check the box next to the display(s) you want to add or check the select all box to select all the displays on the list.
- b. Enter a name for the display in the **Name** field. If you do not enter a name in the field the default name for the display (the IP address for the display followed by the display's model name) will be used.
- c. Enter a description for the display in the **Description** field to provide more detailed information about the display to be viewed in the Information Tab.
- d. Click the numbered button in the **Identify** field to help you identify which display corresponds to the display name shown. Once you click the numbered button, the corresponding display will flash a screen to help you identify the respective display.

- Once you have finished with the options described above, click **Add** to add the selected displays.

Add new device

**Select device(s) to be added**

Checked device(s) will be added. Modify Name/Description fields if needed.

<input checked="" type="checkbox"/>	IP Address	Model	Name	Description	Identify
<input checked="" type="checkbox"/>	192.168.31.111	ST5501K	192.168.31.111-ST5501K		9
<input checked="" type="checkbox"/>	192.168.31.116	RM7502K	192.168.31.116-RM7502K		7
<input checked="" type="checkbox"/>	192.168.31.164	BH2401	192.168.31.164-BH2401		6
<input checked="" type="checkbox"/>	192.168.31.185	RP860K	192.168.31.185-RP860K		2
<input checked="" type="checkbox"/>	192.168.31.188	RM6501K	192.168.31.188-RM6501K		8
<input checked="" type="checkbox"/>	192.168.31.28	BH3501	192.168.31.28-BH3501		1

## Managing Your Displays

Once you have added the display(s) into the DMS Local system, the displays will appear in the device tree on the main page. Initially all newly added display will be listed in the **Uncategorized** group of displays.

The screenshot shows the DMS Local application window. On the left, a tree view shows the 'Uncategorized' group expanded, with several device entries listed. The main area displays a table of these devices with columns for Name, Power, Group, Brand, Model, IP Address, Source, and Status.

<input type="checkbox"/>	Name	Power	Group	Brand	Model	IP Address	Source	Status
<input type="checkbox"/>	192.168.31.28-BH3501	On	Uncategorized	BenQ	ST5501K	192.168.31.111	Android	N/A
<input type="checkbox"/>	192.168.31.185-RP860K	On	Uncategorized	BenQ	BH2401	192.168.31.164	Android	N/A
<input type="checkbox"/>	192.168.31.82-RP704K	On	Uncategorized	BenQ	RP860K	192.168.31.185	Android	N/A
<input type="checkbox"/>	192.168.31.69-RP6501K	On	Uncategorized	BenQ	RM6501K	192.168.31.188	Android	N/A
<input type="checkbox"/>	192.168.31.9-RP750K	On	Uncategorized	BenQ	BH3501	192.168.31.28	Android	N/A
<input type="checkbox"/>	192.168.31.164-BH2401	On	Uncategorized	BenQ	RP6501K	192.168.31.69	Android	N/A
<input type="checkbox"/>	192.168.31.188-RM6501K	On	Uncategorized	BenQ	RP704K	192.168.31.82	Android	N/A
<input type="checkbox"/>	192.168.31.111-ST5501K	On	Uncategorized	BenQ	RP750K	192.168.31.9	Android	N/A

To help you better organize and identify your displays DMS Local features the following options:

- Create Display Groups
- Rename Displays
- Delete Displays

## Creating Groups

In instances where DMS Local is used to manage a large number of displays spread out over various spaces, organizing displays into groups may be useful to manage your displays. To create a display group follow the steps below:

1. Select the **All** category in the device tree, then click the add button (+) and select **Add new group**.



- A sub-group can be created within a group by selecting the group in the device tree that you want to create the sub-group in and then following the steps described in this section.
- A group cannot be created within the **Uncategorized** group in the device tree.

2. In the **Add new group** pop-up window enter a name for the group and then click **Add**.

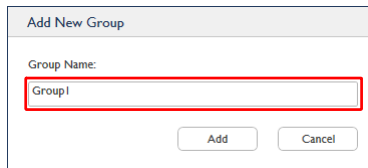

3. Once the new group has been created it will appear in the device tree. You can begin adding displays to the group by selecting the respective display in the device tree, dragging it into the group, and then confirming the addition.

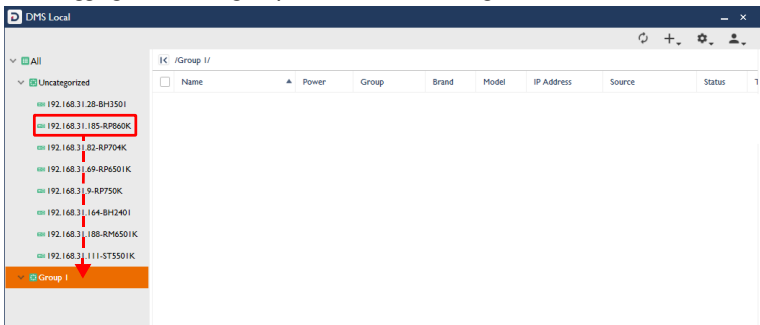

- A display can only be part of one group at a time.

- To rename a group right-click the group you want to rename and select **Rename**.

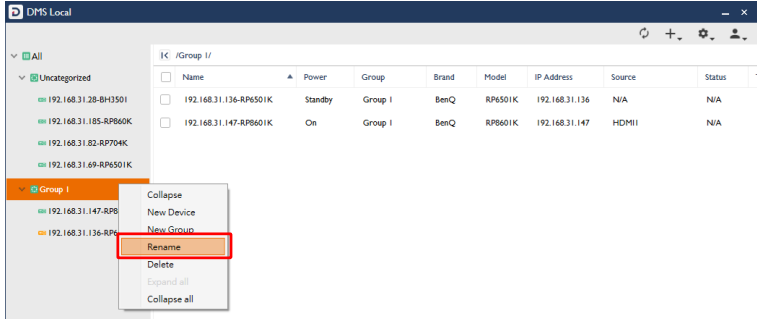

## Renaming a Display

As described in [Adding Displays to DMS Local](#), the **Add new device** menu allows you to rename a display while adding it to DMS Local. In instances where a display is not renamed while it is being added to DMS Local, the display will be added using its default name (the IP address for the display followed by the display's model number), you can then rename a display to a more easily identifiable name in at any time by following the steps below:

- Right-click on the display you want to rename in the device tree, and then select **Rename**.

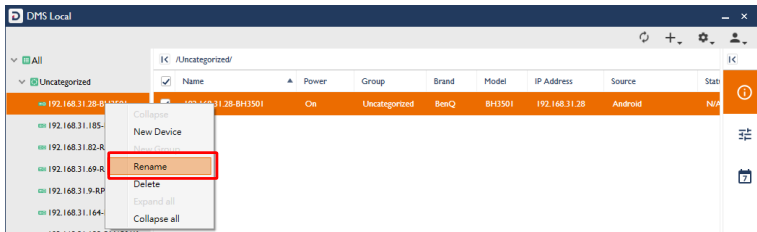

- In the **Rename** menu enter the new name and then click **Rename**.

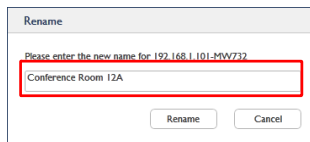

## Deleting a Display

To delete a display from the device tree, right-click on the display you want to delete in the device tree, and then select **Delete**.

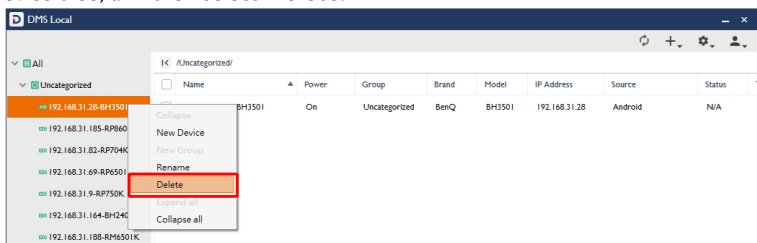



## Device Tree Icons

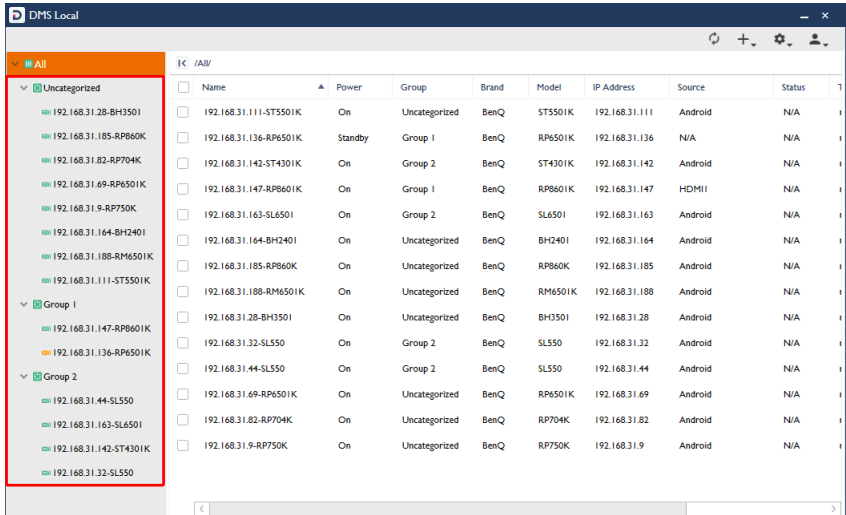

As described earlier, the device tree lists all displays managed by DMS Local in a hierarchical, tree-view structure. The device tree also shows various icons that allow you to quickly view the current status of all displays and whether or not there are any errors causing the display to malfunction.



Name	Power	Group	Brand	Model	IP Address	Source	Status
192.168.31.111-ST5501K	On	Uncategorized	BenQ	ST5501K	192.168.31.111	Android	N/A
192.168.31.136-RP860K	Standby	Group 1	BenQ	RP6501K	192.168.31.136	N/A	N/A
192.168.31.142-ST4301K	On	Group 2	BenQ	ST4301K	192.168.31.142	Android	N/A
192.168.31.147-RP8601K	On	Group 1	BenQ	RP8601K	192.168.31.147	HDMI1	N/A
192.168.31.163-SL6501K	On	Group 2	BenQ	SL6501K	192.168.31.163	Android	N/A
192.168.31.164-BH2401K	On	Uncategorized	BenQ	BH2401K	192.168.31.164	Android	N/A
192.168.31.185-RP860K	On	Uncategorized	BenQ	RP860K	192.168.31.185	Android	N/A
192.168.31.188-RM6501K	On	Uncategorized	BenQ	RM6501K	192.168.31.188	Android	N/A
192.168.31.28-BH3501K	On	Uncategorized	BenQ	BH3501K	192.168.31.28	Android	N/A
192.168.31.32-SL550	On	Group 2	BenQ	SL550	192.168.31.32	Android	N/A
192.168.31.44-SL550	On	Group 2	BenQ	SL550	192.168.31.44	Android	N/A
192.168.31.69-RP6501K	On	Uncategorized	BenQ	RP6501K	192.168.31.69	Android	N/A
192.168.31.82-RP704K	On	Uncategorized	BenQ	RP704K	192.168.31.82	Android	N/A
192.168.31.9-RP750K	On	Uncategorized	BenQ	RP750K	192.168.31.9	Android	N/A

## Status Icons

Icons that indicate the current status of each display appears to the left of the display's name in the device tree. Icons that indicate errors for a display appears to the right of the display's name in the device tree. The table below provides descriptions of each icon.

Icon	Status	Description
	Online	The display is powered on.
	Standby	The display is in standby mode.
	Offline	The display is undetected by DMS Local. This status usually indicates a problem with the display's connection to the network or with the network itself, in such instances it is suggested that you check the display's connection.

## Monitoring Your Displays

Beyond the status icons shown in the device tree, DMS Local features the device panel to monitor the status of your display and the information tab to view detailed information for each display, both of which are described in the sections below.

### The Device Panel

When either an individual display or a display group is selected in the device tree, the device panel of the DMS Local main page will show in-depth status information for the selected display or the displays in the selected group.

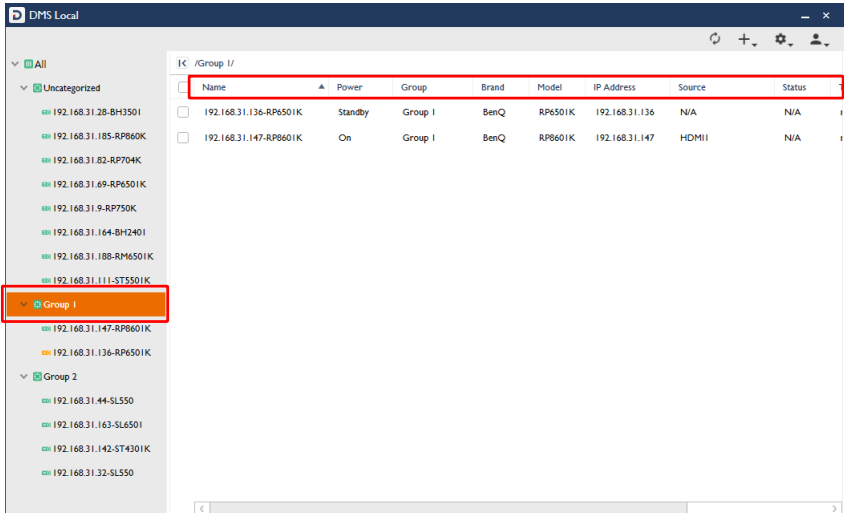

The table below describes the information featured in the device panel.

Item	Description
<b>Name</b>	Name of the display.
<b>Power</b>	Current power status of the display. See <a href="#">Power</a> for definitions of the various power statuses.
<b>Group</b>	Group that the display belongs to.
<b>Brand</b>	Brand of the display.
<b>Model</b>	Model name for display.
<b>IP Address</b>	IP address for the display.
<b>Source</b>	Current signal source for the display.
<b>Status</b>	Current operating status of the display. See <a href="#">Status</a> for definitions of the various statuses.

## Power

The **Power** column in the device panel shows the current power status of the display(s). The following table defines the various power statuses available in the device panel.

Power Status	Description
<b>On</b>	The display is powered on.
<b>Standby</b>	The display is in standby mode.
<b>N/A</b>	The display is undetected by DMS Local. This status usually indicates a problem with the display's connection to the network or with the network itself, in such instances it is suggested that you check the display's connection.

## Status

The **Status** column in the device panel shows the current operating status of the display(s). The following table defines the various statuses available in the device panel.

Status	Description
<b>Normal</b>	The display is operating normally.
<b>N/A</b>	<ul style="list-style-type: none"> <li>• The display does not support the transmission of error messages over the network.</li> <li>• The display is in standby mode.</li> </ul>
<b>Offline</b>	The display is undetected by DMS Local. This status usually indicates a problem with the display's connection to the network or with the network itself, in such instances it is suggested that you check the display's connection.

## The Information Tab

The information tab of DMS Local shows detailed information for a display and is only accessible when a single display is selected in the device panel and the information button in the action panel is clicked.

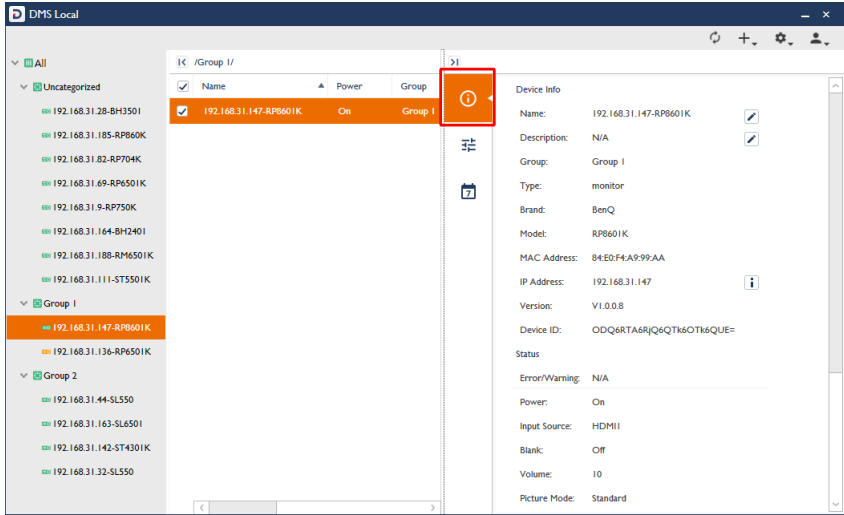

The table below describes the detailed information featured in the information tab.

Item	Description
<b>Name</b>	Name of the display.
<b>Description</b>	Shows the description given to the display during the adding procedure.
<b>Group</b>	Group that the display belongs to.
<b>Type</b>	Describes the type of device/display (e.g. monitor, IFP, Signage, etc.).
<b>Brand</b>	Brand of the display.
<b>Model</b>	Model name for display.
<b>MAC Address</b>	MAC address for the display.
<b>IP Address</b>	IP address for the display.
<b>Version</b>	Indicates the firmware version installed on the display.
<b>Device ID</b>	Unique ID number for the display.
<b>Error/Warning</b>	Not applicable.
<b>Power</b>	Current power status of the display. See <a href="#">Power</a> for definitions of the various power statuses.
<b>Input Source</b>	Current signal source for the display.

---

Item	Description
<b>Blank</b>	Indicates whether the blank screen function for the display is on or off.
<b>Volume</b>	Current volume level for the display.
<b>Picture Mode</b>	Current picture mode setting for the display.
<b>Aspect Ratio</b>	Current aspect ratio for the display
<b>Device Runtime</b>	The current operating time for the display (in hours).



- The fields displayed in the information tab may vary depending on the model selected.
  - If the display does not support the transmission of a certain field's information over the network, the field will show "N/A".
-

## Controlling Your Displays

The control tab of DMS Local features a panel of functions that allows you to control an individual display or an entire display group when they are selected in the device panel and the control button in the action panel is clicked. The control tab also allows users to enter and save control command codes using the BenQ protocol to create custom controls for the display.

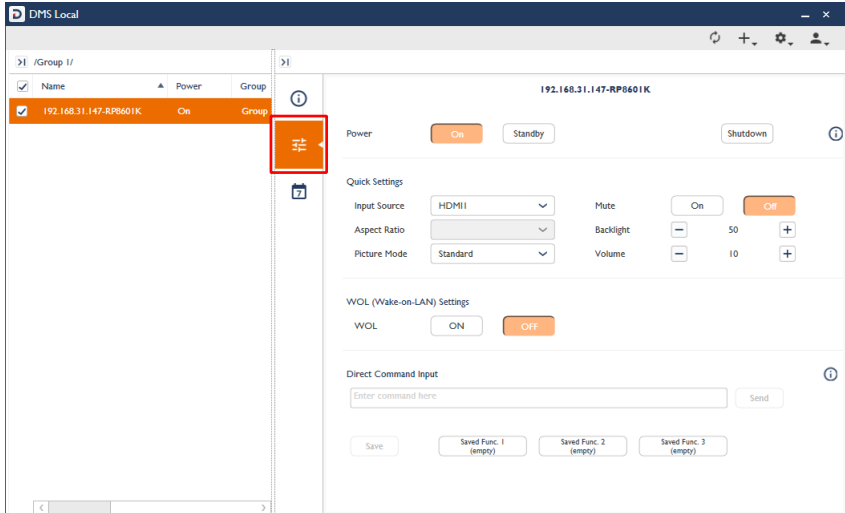

When DMS Local detects a problem with the display's connection to the network all the buttons and fields in the control tab will be greyed out.

The control tab will show different control items depending on what type of selection is made in the device panel, the possible selections include the following:



- A single BenQ display
- Multiple displays in a display group

The sections below describe the control panel for each of the items above.

## The Control Tab (Single BenQ Display)

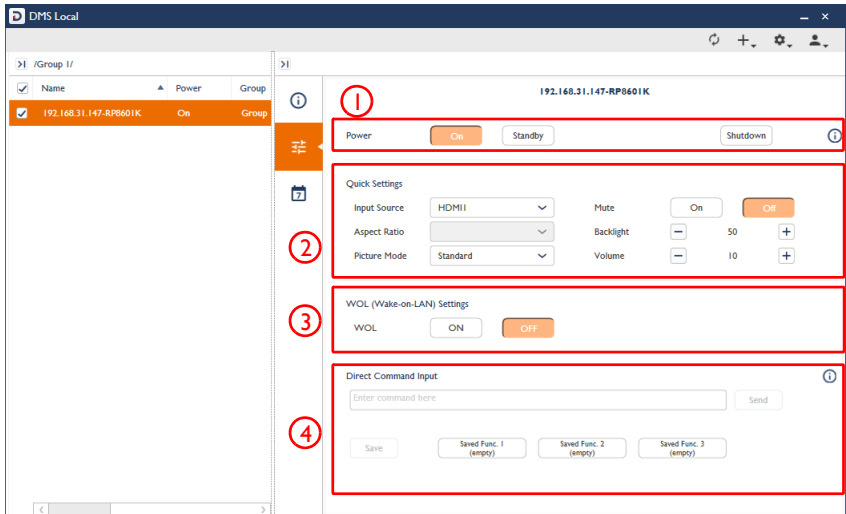
When a single BenQ display is selected in the device panel, the control tab features the following items:





No.	Item	Description
1	<b>Power</b>	<p>Powers on the display, puts it in standby mode, or powers off (shuts down) the display.</p> <p> To be able to power on the display via DMS Local ensure that <b>WOL (Wake-on-LAN) Settings</b> is enabled on the display and that the display is connected to the network via the LAN (RJ-45) port. Wake-on-LAN does not work over a Wi-Fi connection.</p>
2	<b>Quick Settings</b>	<p>Features buttons and menus to control your display.</p> <p>See <a href="#">Quick Settings</a> for more information on the quick settings controls.</p>
3	<b>WOL (Wake-on-LAN) Settings</b>	<p>Allows the display to be able to be powered on remotely from a shutdown state via the LAN port. .</p> <p> The <b>WOL (Wake-on-LAN) Settings</b> function only works on displays that are connected to the network via their LAN (RJ-45) port. Displays that are connected to the network via a Wi-Fi connection will not be able to use the <b>WOL (Wake-on-LAN) Settings</b> function.</p>
4	<b>Direct Control Commands</b>	<p>Send or save custom control command codes for the display using the BenQ protocol for display control.</p> <p>See <a href="#">Direct Command Controls</a> for more information on the basic controls.</p>

## The Control Tab (Multiple Displays)

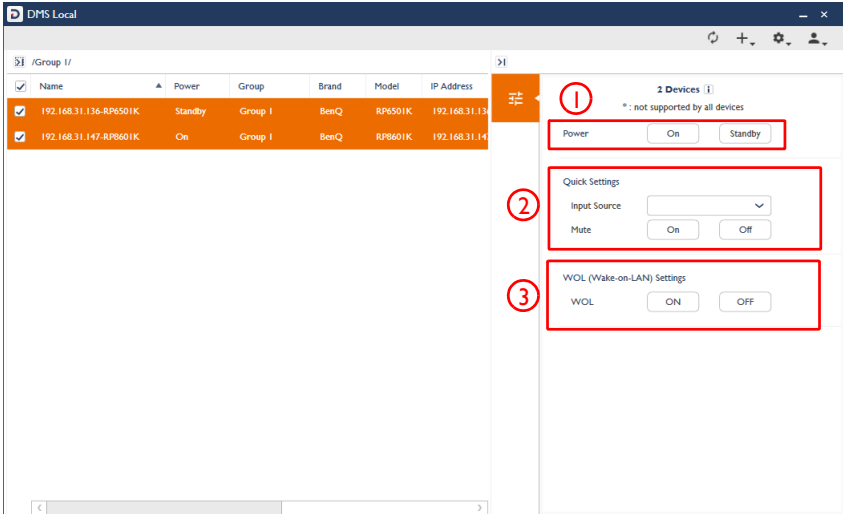
When multiple displays in a display group are selected in the device panel, the control tab features the following items:



No.	Item	Description
1	<b>Power</b>	<p>Powers on the display or puts it in standby mode.</p> <p> To be able to power on the display via DMS Local ensure that <b>WOL (Wake-on-LAN) Settings</b> is enabled on the display and that the display is connected to the network via the LAN (RJ-45) port. Wake-on-LAN does not work over a Wi-Fi connection.</p>
2	<b>Quick Settings</b>	<p>Features buttons and menus to control your display.</p> <p>See <a href="#">Quick Settings</a> for more information on the quick settings controls.</p> <p> Only functions supported by all displays in the group will be supported in the <b>Quick Settings</b> section. Functions that are not supported by all displays will show an <b>Unsupport</b> message.</p>
3	<b>WOL (Wake-on-LAN) Settings</b>	<p>Allows the display to be able to be powered on remotely from a shutdown state via the LAN port.</p> <p> The <b>WOL (Wake-on-LAN) Settings</b> function only works on displays that are connected to the network via their LAN (RJ-45) port. Displays that are connected to the network via a Wi-Fi connection will not be able to use the <b>WOL (Wake-on-LAN) Settings</b> function.</p>



## Quick Settings

The quick settings section of the control tab features the following buttons and menus which help you control your display.

Button	Description
<b>Input Source</b>	Sets the input source for the display.
<b>Mute</b>	Mutes or unmutes the audio output.
<b>Aspect Ratio*</b>	Sets the image aspect ratio for the display.
<b>Backlight*</b>	Sets the brightness level of the backlight for the display.
<b>Picture Mode*</b>	Sets the picture mode for the display.
<b>Volume*</b>	Adjusts the audio volume.
<b>WOL (Wake-on-LAN) Settings*</b>	<p>Allows the display to be able to be powered on remotely from a shutdown state via the LAN port. .</p> <p> The <b>WOL (Wake-on-LAN) Settings</b> function only works on displays that are connected to the network via their LAN (RJ-45) port. Displays that are connected to the network via a Wi-Fi connection will not be able to use the <b>WOL (Wake-on-LAN) Settings</b> function.</p>
*Not available for multiple displays.	



- The fields displayed in the quick settings section may vary depending on the model selected.
- When the display is in standby mode all fields in the quick settings section will be empty.
- When the display is powered on the fields in the quick settings section will be set to the current configurations of the display.
- When DMS Local detects a problem with the display's connection to the network the fields in the quick settings section will be greyed out.

## Direct Command Controls

The direct command control section of the control tab allows you to create custom controls for your display using direct commands, for instance you can create a command to have your display rotate its screen clockwise 90-degrees.



- Functions available to displays that support direct command controls and their corresponding commands vary by model, check the specifications and user manual for your display for available functions and commands.
- Direct command controls can only be used on one display at a time.

The direct command control section is shown below:

### Creating a One-Time-Only Direct Command

To create a one-time-only direct command, follow the steps below:

1. Enter the direct command code in the **Direct Command Input** field.



Commands must be in hexadecimal format. See for more information on creating direct commands see [Direct Command Help](#).

2. Click **Send** and wait for a confirmation that the command has been executed successfully.



To prevent quick changes to the display's state the **Direct Command Input** will be grayed out while DMS Local is confirming whether the direct command is successful. Once the direct command has been confirmed or the confirmation process has timed out the field will return to its normal state.

## Saving a Custom Direct Command Button

To save a direct command as a custom button, follow the steps below:

1. Click the button you want to customize in the direct command control section.



The direct command control section for BenQ displays features 3 direct command buttons available for customization, while the direct command control section for non-BenQ displays features 16 direct command buttons available for customization.

2. In the **Saved Func.** window that appears click the options button (⋮) and select **Edit**.

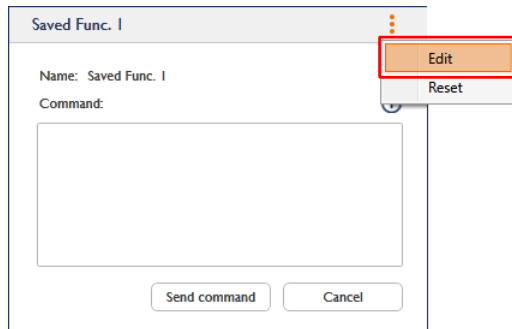

3. In the **Edit Saved Function** window enter a name for the button in the **Name** field and the direct command code in the **Command** field.

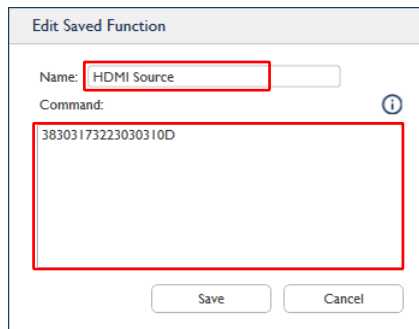

Commands must be in hexadecimal format. See for more information on creating direct commands see [Direct Command Help](#).

4. Click **Save** in the **Edit Saved Function**, your custom direct command button will appear in the direct command control section of the control panel, which you can click to send the command.

## Direct Command Help

If you need help with creating direct commands in DMS Local, you can click the help button  located in the direct command control section for guidelines on creating direct commands.



Direct Command Input





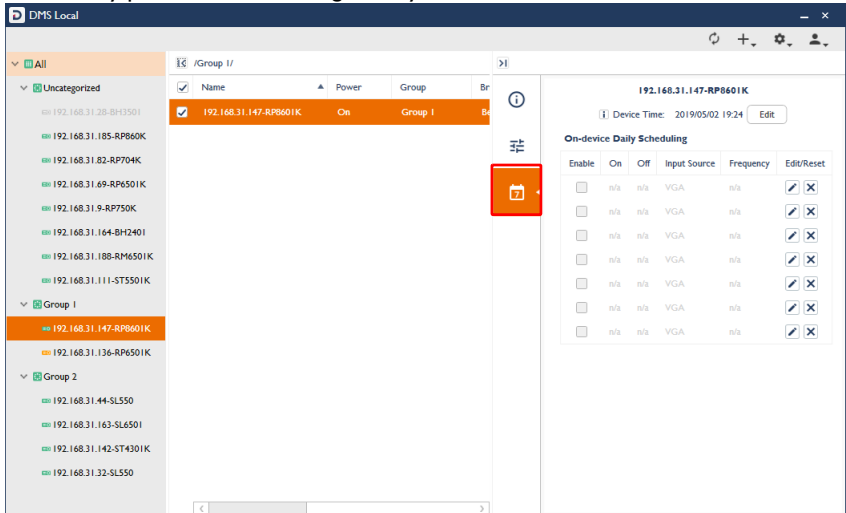

## Scheduling a Task for Your Displays

The schedule tab of DMS Local allows you to create a power on/off schedule for an individual display when it is selected in the device panel, where the display will automatically power on or off at a given day/time.



The table below describes the items featured in the schedule tab:

Item	Description
<b>Edit</b>	Click to change the system date and time on the selected display.  Editing a display's system date/time is to ensure that the desired date and time is configured so that scheduled tasks are initiated at the right date and time.
<b>Enable</b>	Check the box for a scheduled task in this column to enable that task.  Scheduled tasks which have an unchecked box are disabled and will be grayed out.
<b>On</b>	Shows the time at which the display will power on.
<b>Off</b>	Shows the time at which the display will power off.
<b>Input Source</b>	Shows the input source that the display will be set to when it is powered on according to the schedule.
<b>Frequency</b>	Shows either the specific date or the days of the week when the schedule is active.
<b>Edit / Delete</b>	Click the edit button (  ) to edit the scheduled task, click the delete button (  ) to delete the scheduled task.

## Editing a Scheduled Task

The schedule tab of DMS Local is pre-configured to include multiple line items, which you can edit to create a scheduled task. To edit an item to create a scheduled task, follow the steps below:

1. Select the display(s) you want the scheduled task to apply to in the device panel and then click the schedule tab.
2. Click the edit button (✎) for the item in the schedule tab you want to edit.
3. Configure the following items in the **Edit on-device daily scheduling** menu:

The screenshot shows the 'Edit on-device daily scheduling' window. At the top, the 'Device Name' is '192.168.31.147-RP8601K'. Below this are two rows for scheduling: 'Power On' and 'Power Off'. Each row has a checkbox (labeled 'a'), a time selector (labeled 'b'), and a dropdown for 'Input Source' (labeled 'c'). The 'Input Source' is currently set to 'VGA'. Below these is a 'Repeat' section with a dropdown set to 'Custom day' (labeled 'd') and a row of checkboxes for days of the week: S, M, T, W, T, F, S (labeled 'e'). At the bottom are 'Save' and 'Cancel' buttons.

- a. Check the box next to task you want the display to perform based on the set schedule.
  - b. Set the time when you want the task to be performed.
  - c. Set the video input source you want the display to be set to for the scheduled task.
  - d. If you want the display to perform the task on a specific date click the **Custom day** field and select the date for the task to occur.
  - e. If you want the task to repeat on given days of the week check the box for the corresponding day.
4. Click the **Save** button in the **Edit on-device daily scheduling** menu to finish creating the scheduled task. By default the created task will automatically be enabled.

## Setting a Login Password for DMS Local

To ensure that access to DMS Local is secure and only for designated personnel, you can set a login password for DMS Local that needs to be entered every time DMS Local is launched. To set a login password for DMS Local, follow the steps below:

1. Click the user button (  ) in the DMS Local main page and select **Change password**.

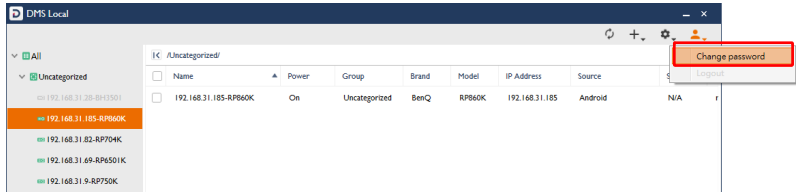

2. In the **Change password** menu enter the password you want to set as the login password in both the **New password** and **Confirm password** fields. If DMS Local already features a login password enter the current password in the **Current password** field.

Change password

Account ID    User

Current password

New password

Confirm password



If you want to remove the existing password, click the **Remove Password** button in the **Change password** menu.

3. Click **Save** to finish setting a login password for DMS Local.



If you forget your login password for DMS Local, click the **Forget password?** link at the bottom of the login window and contact your local BenQ service team to provide them with the password retrieval code shown in the **Forget password?** prompt.

## Other Functions

DMS Local also features the following functions to further help you manage your displays:

- Export display listings to the cloud
- Backup DMS Local's display listings

### Export Display Listings

To export the list of displays and groups from the DMS Local device tree to the DMS Cloud server so that users of DMS Cloud can import the list of displays directly from the cloud, click the settings button (⚙️) in the DMS Local main page and select **Export for DMS Cloud (CSV)**.

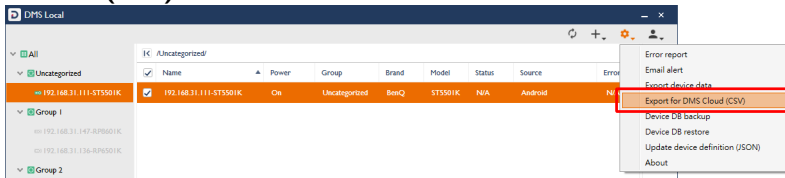

### Backup Display Listings

To backup the list of displays and groups from the DMS Local device tree and their relevant data for data backup purposes or to transfer the list to another computer, follow the steps below:

1. Click the settings button (⚙️) in the DMS Local main page and select **Device DB backup**.

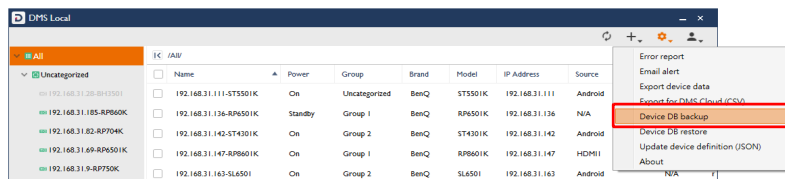

2. Navigate to the folder you want to save the backup to in the pop-up window.



The backup file only saves the device tree and group settings for the displays, it will not save any command controls or scheduled tasks.

To restore the backup file or load the backup file on a new computer follow the steps below:

1. Click the settings button (⚙️) in the DMS Local main page and select **Device DB restore**.

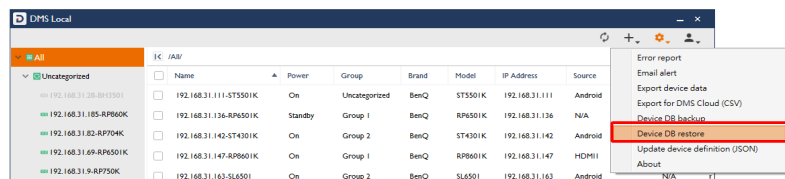

2. Navigate the location where the backup file is located to in the pop-up window.



## About DMS Local

For more information regarding DMS Local including software version, click the settings button (⚙️) in the DMS Local main page and select **About**.

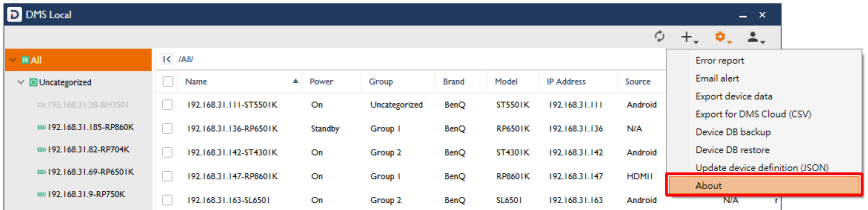

The screenshot shows the DMS Local application window. On the left, there is a sidebar with a tree view under 'All' containing 'Uncategorized' and several device entries with their IP addresses and model numbers. The main area displays a table of devices. A settings menu is open in the top right corner, listing various options. The 'About' option is highlighted with a red box.

<input type="checkbox"/>	Name	Power	Group	Brand	Model	IP Address	Source
<input type="checkbox"/>	192.168.31.111-ST5501K	On	Uncategorized	BenQ	ST5501K	192.168.31.111	Android
<input type="checkbox"/>	192.168.31.136-RP6501K	Standby	Group 1	BenQ	RP6501K	192.168.31.136	N/A
<input type="checkbox"/>	192.168.31.142-ST4301K	On	Group 2	BenQ	ST4301K	192.168.31.142	Android
<input type="checkbox"/>	192.168.31.147-RP8601K	On	Group 1	BenQ	RP8601K	192.168.31.147	HDMI
<input type="checkbox"/>	192.168.31.163-SL6501	On	Group 2	BenQ	SL6501	192.168.31.163	Android

- Error report
- Email alert
- Export device data
- Export for DMS Cloud (CSV)
- Device DB backup
- Device DB restore
- Update device definition (JSON)
- About**
- N/A

## Troubleshooting

If you encounter problems while using the DMS Local, please refer to the following troubleshooting tips to try to solve the problems by yourself. If the problem persists, please contact BenQ Customer Support for help.

Problem	Solution
Cannot connect to the display(s)	Check the following: <ul style="list-style-type: none"> <li>• Check the cable connection. Is the display correctly connected to the computer?</li> <li>• Is the display turned on?</li> <li>• Is the display's network setting correct?</li> </ul>
Cannot power on the display via DMS Local	<ul style="list-style-type: none"> <li>• Ensure that <b>WOL (Wake-on-LAN) Settings</b> is enabled on the display.</li> <li>• Ensure that the display is connected to the network via the LAN (RJ-45) port. Wake-on-LAN does not work over a Wi-Fi connection.</li> </ul>
Cannot add a display into DMS Local	<ul style="list-style-type: none"> <li>• Update the database of displays (JSON) in DMS Local.</li> </ul>

---

## Appendix: About DMS Cloud

BenQ's cloud-based device management software, DMS Cloud, is also available for management of remote displays. For more information on DMS Cloud and its features see the links below:

- DMS Cloud and its functions  
<https://youtu.be/0jyzb8yqNlk>
- Adding devices using QR code  
[https://youtu.be/uQ\\_WsojPvQc](https://youtu.be/uQ_WsojPvQc)
- Adding devices using unique IDs  
<https://youtu.be/aHHtCbGiIH0>