



TH671ST
Digital Projector
User Manual

Warranty and Copyright information

Limited warranty

BenQ warrants this product against any defects in material and workmanship, under normal usage and storage.

Proof of purchase date will be required with any warranty claim. In the event this product is found to be defective within the warranty period, BenQ's only obligation and your exclusive remedy shall be replacement of any defective parts (labor included). To obtain warranty service, immediately notify the dealer from which you purchased the product of any defects.

Important: The above warranty shall be void if the customer fails to operate the product in accordance with BenQ's written instructions, especially the ambient humidity must be in-between 10% and 90%, temperature in-between 0°C and 35°C, altitude lower than 4920 feet, and avoiding to operate the projector in a dusty environment. This warranty gives you specific legal rights, and you may have other rights which vary from country to country.

For other information, please visit www.BenQ.com.

Copyright

Copyright © 2017 by BenQ Corporation. All rights reserved. No part of this publication may be reproduced, transmitted, transcribed, stored in a retrieval system or translated into any language or computer language, in any form or by any means, electronic, mechanical, magnetic, optical, chemical, manual or otherwise, without the prior written permission of BenQ Corporation.

Disclaimer

BenQ Corporation makes no representations or warranties, either expressed or implied, with respect to the contents hereof and specifically disclaims any warranties, merchantability or fitness for any particular purpose. Further, BenQ Corporation reserves the right to revise this publication and to make changes from time to time in the contents hereof without obligation to notify any person of such revision or changes.

*DLP, Digital Micromirror Device and DMD are trademarks of Texas Instruments. Others are copyrights of their respective companies or organizations.

Patents

Please go to <http://patmarking.benq.com/> for the details on BenQ projector patent coverage.

Table of Contents

Warranty and Copyright information	2
Important safety instructions	4
Introduction	7
Shipping contents	7
Projector exterior view	8
Controls and functions.....	9
Positioning your projector	12
Choosing a location	12
Obtaining a preferred projected image size.....	13
Mounting the projector.....	14
Adjusting the projected image	15
Connection	17
Operation	19
Starting up the projector	19
Using the menus	21
Securing the projector	23
Switching input signal	25
Shutting down the projector	26
Direct power off	26
Menu operation	27
Basic menu	27
Advanced menu	30
Maintenance	38
Care of the projector	38
Lamp information	38
Troubleshooting	44
Specifications	45
Projector specifications	45
Dimensions	46
Timing chart.....	47

Important safety instructions

Your projector is designed and tested to meet the latest standards for safety of information technology equipment. However, to ensure safe use of this product, it is important that you follow the instructions mentioned in this manual and marked on the product.

1. **Please read this manual before you operate your projector.** Save it for future reference.



2. **Do not look straight at the projector lens during operation.** The intense light beam may damage your eyes.



3. **Refer servicing to qualified service personnel.**



4. **Always open the lens shutter (if any) or remove the lens cap (if any) when the projector lamp is on.**

5. The lamp becomes extremely hot during operation. Allow the projector to cool for approximately 45 minutes prior to removing the lamp assembly for replacement.



6. In some countries, the line voltage is NOT stable. This projector is designed to operate safely within a mains voltage between 100 to 240 volts AC, but could fail if power cuts or surges of ± 10 volts occur. **In areas where the mains voltage may fluctuate or cut out, it is recommended that you connect your projector through a power stabilizer, surge protector or uninterruptible power supply (UPS).**

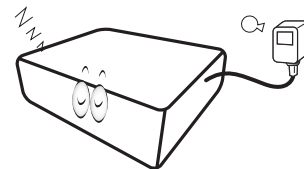

7. Do not block the projection lens with any objects when the projector is under operation as this could cause the objects to become heated and deformed or even cause a fire. To temporarily turn off the lamp, use the blank function.



8. Do not operate lamps beyond the rated lamp life. Excessive operation of lamps beyond the rated life could cause them to break on rare occasions.



9. Never replace the lamp assembly or any electronic components unless the projector is unplugged.

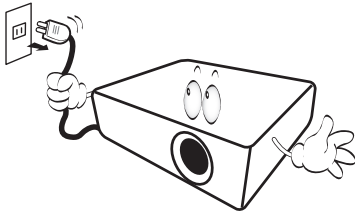

10. Do not place this product on an unstable cart, stand, or table. The product may fall, sustaining serious damage.

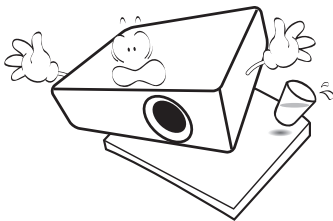

11. Do not attempt to disassemble this projector. There are dangerous high voltages inside which may cause death if you should come into contact with live parts. The only user serviceable part is the lamp which has its own removable cover.

Under no circumstances should you ever undo or remove any other covers. Refer servicing only to suitably qualified professional service personnel.

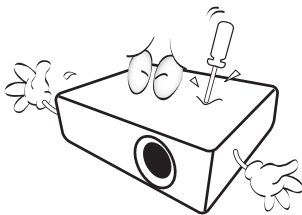

12. Do not block the ventilation holes.

- Do not place this projector on a blanket, bedding or any other soft surface.
- Do not cover this projector with a cloth or any other item.
- Do not place inflammables near the projector.

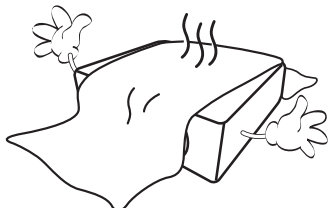

If the ventilation holes are seriously obstructed, overheating inside the projector may result in a fire.

13. Always place the projector on a level, horizontal surface during operation.

- Do not use if tilted at an angle of more than 10 degrees left to right, nor at angle of more than 15 degrees front to back. Using the projector when it is not fully horizontal may cause a malfunction of, or damage to, the lamp.

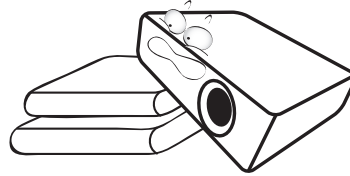

14. Do not stand the projector on end vertically. Doing so may cause the projector to fall over, causing injury or resulting in damage to the projector.

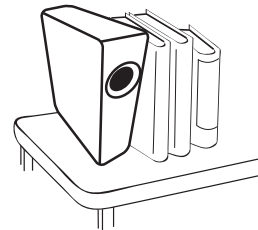

15. Do not step on the projector or place any objects upon it. Besides probable physical damage to the projector, doing so may result in accidents and possible injury.

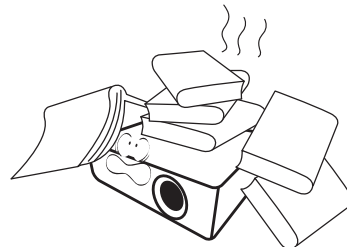

16. When the projector is under operation, you may sense some heated air and odor from its ventilation grill. It is a normal phenomenon and not a product defect.

17. Do not place liquids near or on the projector. Liquids spilled into the projector may cause it to fail. If the projector does become wet, disconnect it from the power supply's power outlet and call BenQ to have the projector serviced.

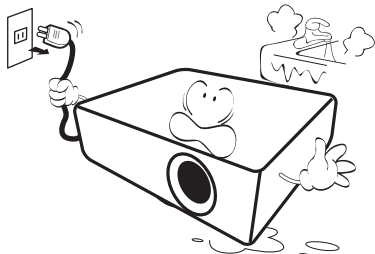

18. This product is capable of displaying inverted images for ceiling/wall mount installation.

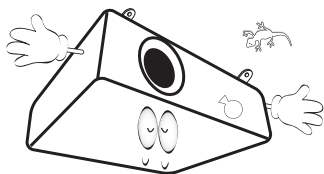

19. This apparatus must be earthed.



Hg - Lamp contains mercury. Manage in accordance with local disposal laws. See www.lamprecycle.org.

20. Do not place this projector in any of the following environments.

- Space that is poorly ventilated or confined. Allow at least 50 cm clearance from walls and free flow of air around the projector.
- Locations where temperatures may become excessively high, such as the inside of a car with all windows rolled up.
- Locations where excessive humidity, dust, or cigarette smoke may contaminate optical components, shorten the projector's life span and darken the image.

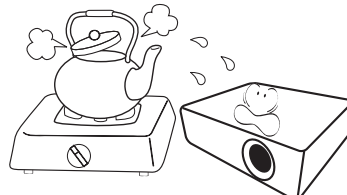

- Locations near fire alarms
- Locations with an ambient temperature above 40°C / 104°F
- Locations where the altitudes are higher than 3000 m (10000 feet).

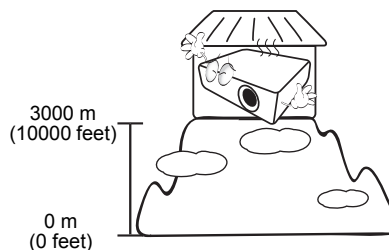

Introduction

Shipping contents

Carefully unpack and verify that you have all of the items shown below. If any of these items are missing, please contact your place of purchase.

Standard accessories

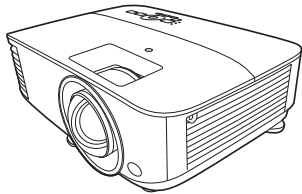

Projector

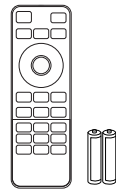

Remote control with batteries



User manual CD



Quick start guide



Warranty card*

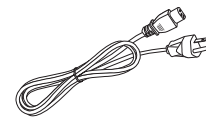

Power cord



- The supplied accessories will be suitable for your region, and may differ from those illustrated.
- *The warranty card is only supplied in some specific regions. Please consult your dealer for detailed information.

Optional accessories

1. Spare lamp kit
2. 3D glasses
3. Dust filter
4. Wireless dongles (QCast & QCast Mirror)
5. Wireless kit (WDP02)

Replacing the remote control batteries

1. Press and open the battery cover, as illustrated.
2. Remove the old batteries (if applicable) and install two AAA batteries. Make sure that the positive and negative ends are positioned correctly, as illustrated.
3. Replace the battery cover until it clicks into place.

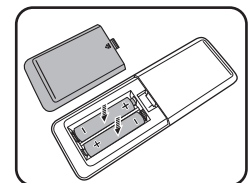
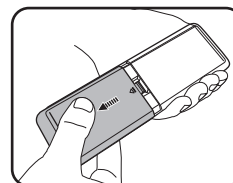

- Avoid leaving the remote control and batteries in an excessive heat or humid environment like the kitchen, bathroom, sauna, sunroom or in a closed car.
- Replace only with the same or equivalent type recommended by the battery manufacturer.
- Dispose of the used batteries according to the manufacturer's instructions and local environment regulations for your region.
- Never throw the batteries into a fire. There may be danger of an explosion.
- If the batteries are dead or if you will not be using the remote control for an extended period of time, remove the batteries to avoid damage to the remote control from possible battery leakage.

Projector exterior view

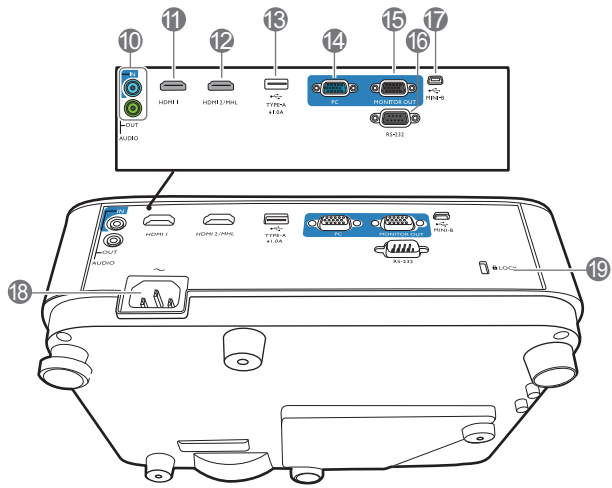
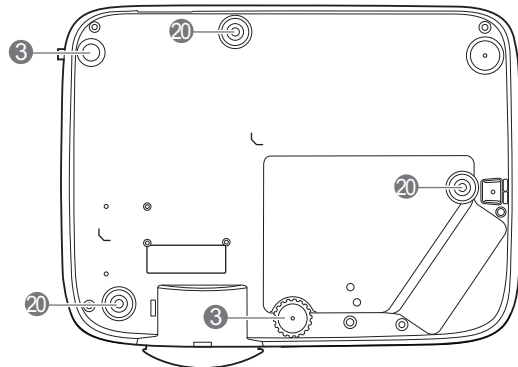
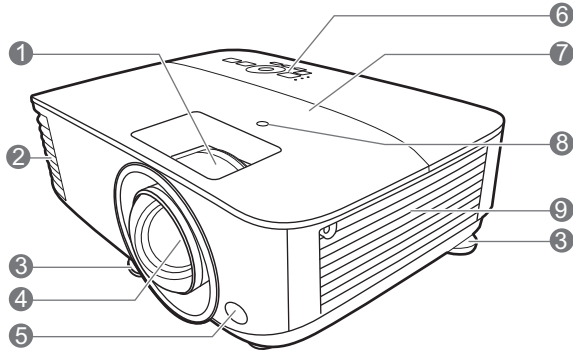

- 1. Focus ring and Zoom ring
- 2. Vent (air exhaust)
- 3. Adjuster feet
- 4. Projection lens
- 5. IR remote sensor
- 6. External control panel
(See [Controls and functions on page 9.](#))
- 7. Lamp cover
- 8. Ambient Light Sensor (ALS)
- 9. Vent (air inlet)
- 10. Audio input jack
Audio output jack
- 11. HDMI I input port
- 12. HDMI 2/MHL-input port (for HDMI dongle)

- 13. USB Type A port
- 14. RGB (PC) signal input jack
- 15. RGB (PC) signal output jack
- 16. RS-232 control port
- 17. USB Mini-B port
- 18. AC power jack
- 19. Kensington anti-theft lock slot
- 20. Wall mount holes

Controls and functions

Projector & Remote control



All the key presses described in this document are available on the remote control or projector.

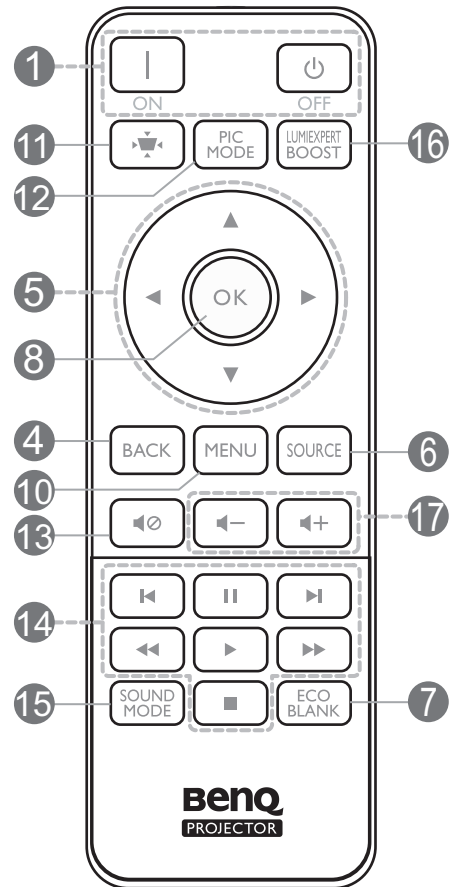
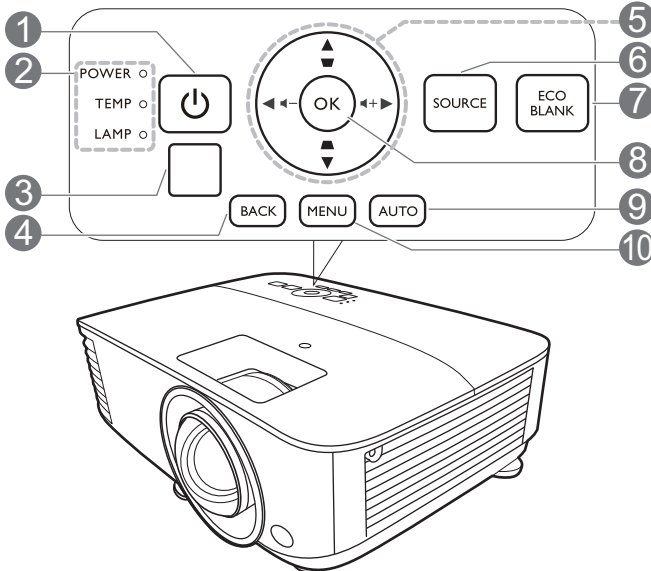

1. **POWER**

Toggles the projector between standby mode and on.



Toggles the projector between standby mode and on.

2. **POWER indicator light/TEMPerature warning light/LAMP indicator light** (See [Indicators on page 43.](#))

3. IR remote sensor

4. **BACK**

Goes back to previous OSD menu, exits and saves menu settings.

5. Arrow keys (▲, ▼, ◀, ▶)

When the On-Screen Display (OSD) menu is activated, these keys are used as directional arrows to select the desired menu items and to make adjustments.

Keystone keys (△, ▽)

Displays the keystone correction page.

Volume keys ◀- / ▶+

Decreases or increase the projector volume.

6. **SOURCE**

Displays the source selection bar.

7. **ECO BLANK**

Used to hide the screen picture.



Do not block the projection lens from projecting as this could cause the blocking object to become heated and deformed or even cause a fire.

8. **OK**

Confirms the selected On-Screen Display (OSD) menu item.

9. **AUTO**

Automatically determines the best picture timings for the displayed image when PC signal (analog RGB) is selected.

10. **MENU**

Turns on the On-Screen Display (OSD) menu.

11.

Displays the keystone menu.

12. **PIC MODE**

Selects the picture mode.

13.

Toggles projector audio between on and off.

14. **MHL Zone**

Controls video or audio playback under MHL source.

15. **SOUND MODE**

Selects the sound mode.

16. **LUMIEXPERT BOOST**

Displays the LumiExpert Boost menu.

17. Volume keys /

Decreases or increases the projector volume.

Controlling your smart device with the **AUTO** button

When the projector projects the content from your MHL compatible smart device, you can use the remote control to control your smart device.

To enter the MHL mode, press and hold **AUTO** on the projector keypad for 3 seconds. The **MHL Zone** keys on the remote control are available for controlling your smart device.

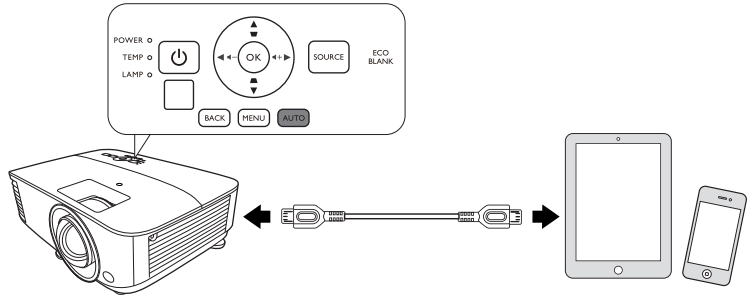

When the projector is under MHL mode, the keypad on the projector should be with the same definition of the keys on the remote control.

Remote control effective range

The remote control must be held at an angle within 30 degrees perpendicular to the projector's IR remote control sensor(s) to function correctly. The distance between the remote control and the sensor(s) should not exceed 8 meters (~ 26 feet).

Make sure that there are no obstacles between the remote control and the IR sensor(s) on the projector that might obstruct the infra-red beam.

- Operating the projector from the front

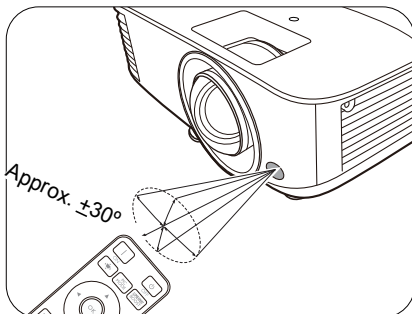

- Operating the projector from the top

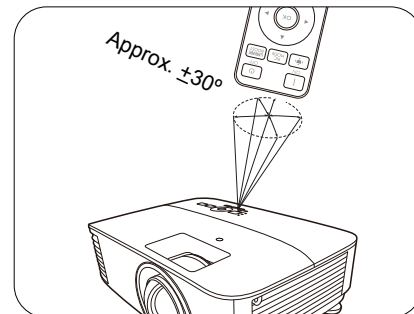

Positioning your projector

Choosing a location

Before choosing an installation location for your projector, take the following factors into consideration:

- Size and position of your screen
- Electrical outlet location
- Location and distance between the projector and the rest of your equipment

You can install your projector in the following ways.

1. Front

Select this location with the projector placed on the table in front of the screen. This is the most common way to position the projector for quick setup and portability.

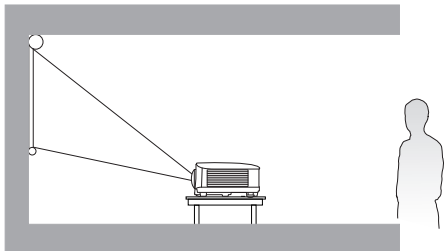

2. Rear

Select this location with the projector placed on the table behind the screen. Note that a special rear projection screen is required.

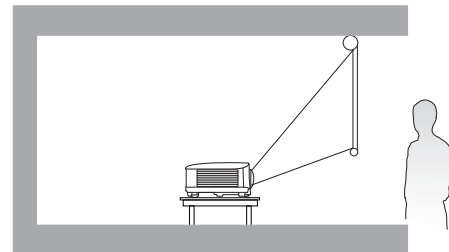

3. Front Ceiling

Select this location with the projector suspended upside-down in front of the screen. Purchase the BenQ Projector Ceiling/Wall Mount Kit from your dealer to mount your projector.

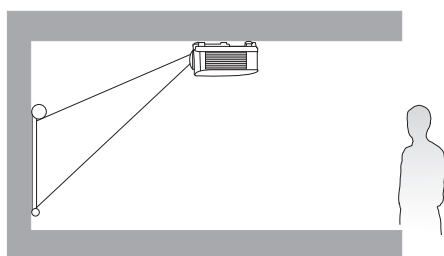

4. Rear Ceiling

Select this location with the projector suspended upside-down from behind the screen. Note that a special rear projection screen and the BenQ Projector Ceiling/Wall Mount Kit are required for this installation location.

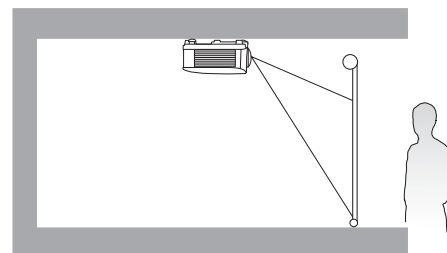

After turning on the projector, go to **Advanced Menu - System Setup : Basic > Projector Position** and press ◀/▶ to select a setting.

Obtaining a preferred projected image size

The distance from the projector lens to the screen, the zoom setting (if available), and the video format each factors in the projected image size.

Projection dimensions

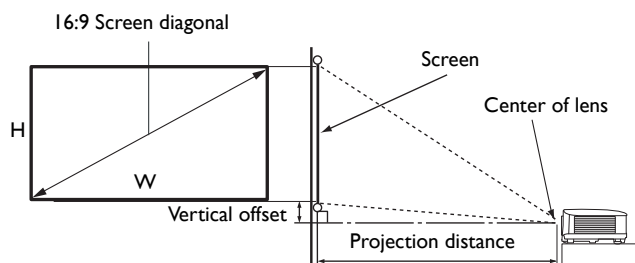

- The screen aspect ratio is 16:9 and the projected picture is in a 16:9 aspect ratio

Screen size			Projection distance (mm)			Offset lens position (mm)	
Diagonal		H (mm)	W (mm)	Min. distance	Average		Max. distance
Inch	mm			(max. zoom)			(min. zoom)
60	1524	747	1328	917	1009	1102	19
70	1778	872	1550	1069	1178	1286	22
80	2032	996	1771	1222	1346	1470	25
90	2286	1121	1992	1375	1514	1654	28
100	2540	1245	2214	1528	1682	1837	31
110	2794	1370	2435	1680	1851	2021	34
120	3048	1494	2657	1833	2019	2205	37
140	3556	1743	3099	2139	2355	2572	44
160	4064	1992	3542	2444	2692	2940	50
180	4572	2241	3985	2750	3028	3307	56

For example, if you are using a 120-inch screen, the recommended projection distance is 2019 mm.

- If your measured projection distance is 2300 mm, the closest match in the "Projection distance (mm)" column is 2355 mm. Looking across this row shows that a 140" (about 3.6 m) screen is required.



All measurements are approximate and may vary from the actual sizes.

BenQ recommends that if you intend to permanently install the projector, you should physically test the projection size and distance using the actual projector in situ before you permanently install it, so as to make allowance for this projector's optical characteristics. This will help you determine the exact mounting position so that it best suits your installation location.

Mounting the projector

If you intend to mount your projector, we strongly recommend that you use a proper fitting BenQ projector mounting kit and that you ensure it is securely and safely installed.

If you use a non-BenQ brand projector mounting kit, there is a safety risk that the projector may fall down due to an improper attachment through the use of the wrong gauge or length screws.

Before mounting the projector

- Purchase a BenQ projector mounting kit from the place you purchased your BenQ projector.
- BenQ recommends that you also purchase a separate Kensington lock compatible security cable and attach it securely to both the Kensington lock slot on the projector and the base of the mounting bracket. This will perform the secondary role of restraining the projector should its attachment to the mounting bracket become loose.
- Ask your dealer to install the projector for you. Installing the projector on your own may cause it to fall and result in injury.
- Take necessary procedures to prevent the projector from falling off such as during an earthquake.
- The warranty doesn't cover any product damage caused by mounting the projector with a non-BenQ brand projector mounting kit.
- Consider the surrounding temperature where the projector is ceiling/wall mounted. If a heater is used, the temperature around the ceiling/wall may be higher than expected.
- Read the user manual for the mounting kit about the range of torque. Tightening with torque exceeding the recommended range may cause damage to the projector and subsequently falling off.
- Make sure the power outlet is at an accessible height so that you can easily shut down the projector.

Ceiling/Wall mount installation diagram

Ceiling/Wall mount screw: M4
(Max L = 25 mm; Min L = 20 mm)

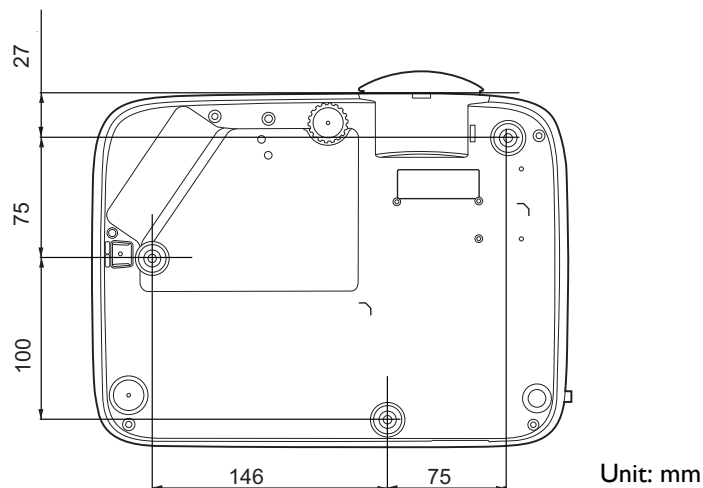

Adjusting the projected image

Adjusting the projection angle

If the projector is not placed on a flat surface or the screen and the projector are not perpendicular to each other, the projected image becomes trapezoidal. You can screw the adjuster feet to fine-tune the horizontal angle.

To retract the feet, screw the adjuster feet in a reverse direction.

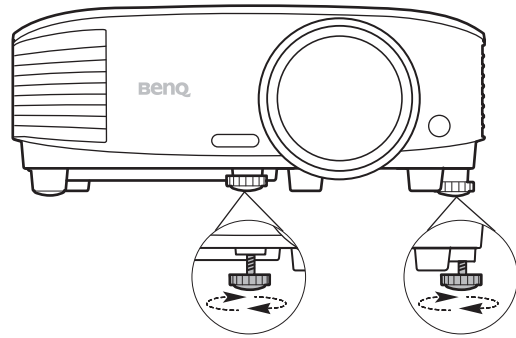

Do not look into the lens while the lamp is on. The strong light from the lamp may cause damage to your eyes.

Auto-adjusting the image

In some cases, you may need to optimize the picture quality. To do this, press **AUTO**. Within 3 seconds, the built-in Intelligent Auto Adjustment function will re-adjust the values of Frequency and Clock to provide the best picture quality.

The current source information will be displayed in the corner of the screen for 3 seconds.



This function is only available when PC signal (analog RGB) is selected.

Fine-tuning the image size and clarity

Adjust the projected image to the size that you need using the zoom ring.

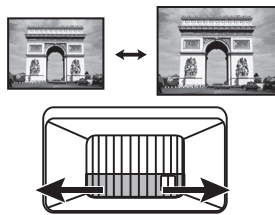

Sharpen the image by rotating the focus ring.

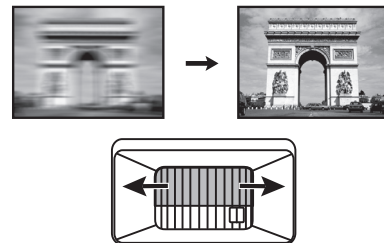

Correcting keystone

Keystoning refers to the situation where the projected image becomes a trapezoid due to angled projection.

To correct this, you will need to manually correct it following these steps.

1. Do one of the following steps to display the keystone correction page.

- Press \triangle / ∇ on the projector.
- Press  on the remote control.



2. After the **Keystone** correction page displays. Press \triangle to correct keystone at the top of the image. Press ∇ to correct keystone at the bottom of the image.

Connection

When connecting a signal source to the projector, be sure to:

1. Turn all equipment off before making any connections.
2. Use the correct signal cables for each source.
3. Ensure the cables are firmly inserted.

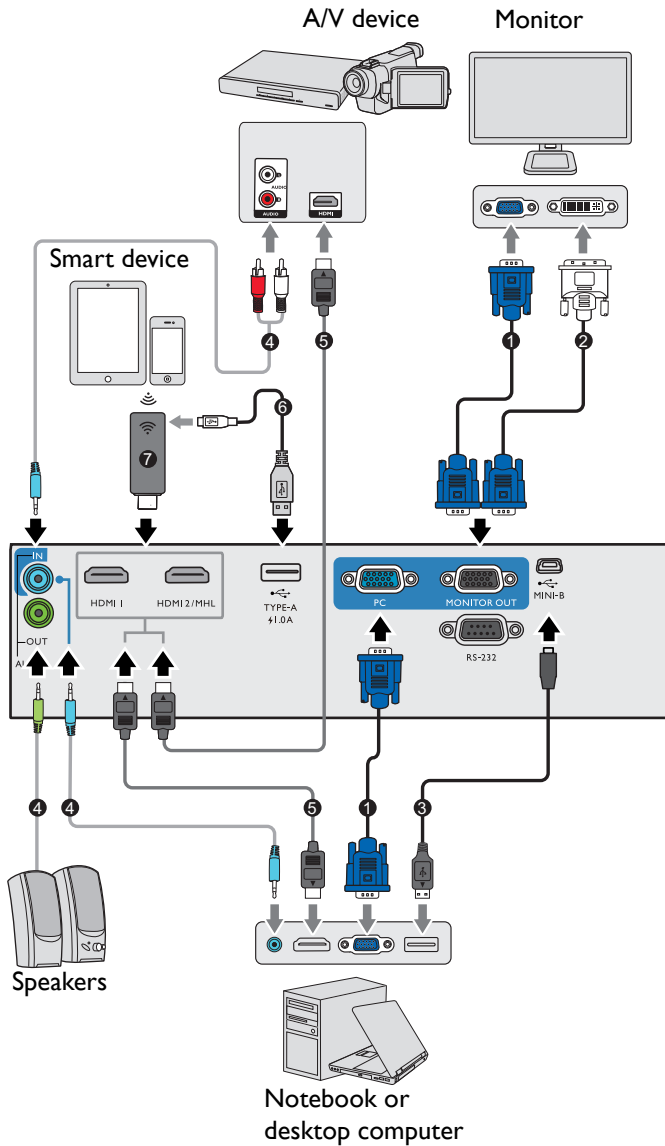



1	VGA cable
2	VGA to DVI-A cable
3	USB cable
4	Audio cable
5	HDMI cable
6	USB cable (A to Micro B type) connect to the power port of HDMI wireless dongle
7	HDMI wireless dongle



- In the connections above, some cables may not be included with the projector (see [Shipping contents on page 7](#)). They are commercially available from electronics stores.
- The connection illustrations are for reference only. The rear connecting jacks available on the projector vary with each projector model.
- Many notebooks do not turn on their external video ports when connected to a projector. Usually a key combo like FN + function key with a monitor symbol turns the external display on/off. Press FN and the labeled function key simultaneously. Refer to your notebook's documentation to find your notebook's key combination.
- If the selected video image is not displayed after the projector is turned on and the correct video source has been selected, check that the video source device is turned on and operating correctly. Also check that the signal cables have been connected correctly.

You need only connect the projector to a video source device using just one of the connecting methods, however each provides a different level of video quality.

Terminal		Picture quality
HDMI/MHL		Better
PC		Good

Connecting audio

The projector has built-in mono speaker(s) which are designed to provide basic audio functionality accompanying data presentations for business purposes only. They are not designed for, nor intended for stereo audio reproduction use as might be expected in home theater or home cinema applications. Any stereo audio input (if provided), is mixed into a common mono audio output through the projector speaker(s).



The built-in speaker(s) will be muted when the **AUDIO OUT** jack is connected.



- The projector is only capable of playing mixed mono audio, even if a stereo audio input is connected.
- If the selected video image is not displayed after the projector is turned on and the correct video source has been selected, check that the video source device is turned on and operating correctly. Also check that the signal cables have been connected correctly.





Operation

Starting up the projector

1. Plug the power cord. Turn on the power outlet switch (where fitted). The power indicator on the projector lights orange after power has been applied.
2. Press  on the projector or  on the remote control to start the projector. The power indicator flashes green and stays green when the projector is on.

The start up procedure takes about 30 seconds. In the later stage of start up, a startup logo is projected.

(If necessary) Rotate the focus ring to adjust the image clearness.

3. If this is the first time you turn on the projector, the setup wizard appears to guide you through setting up the projector. If you have already done this, skip this step and move on to step 5.
 - Use the arrow keys (///) on the projector or remote control to move through the menu items.
 - Use **OK** to confirm the selected menu item.

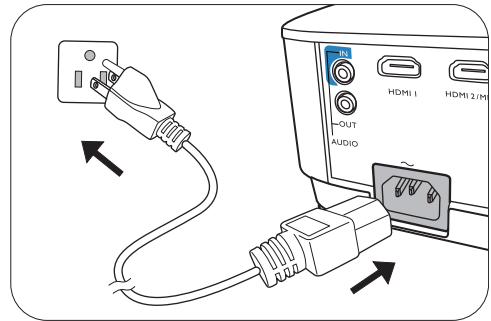

 The Setup Wizard screenshots below are for reference only and may differ from the actual design.

Step 1:

Specify **Projector Position**.

 For more information about projector position, see [Choosing a location](#).

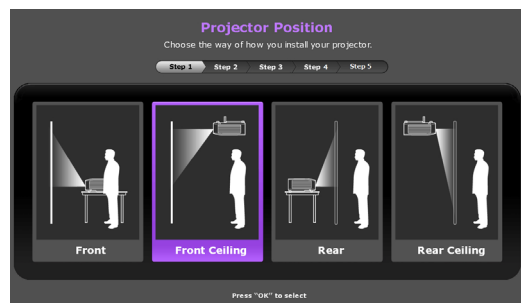

Step 2:

Specify OSD **Language**.

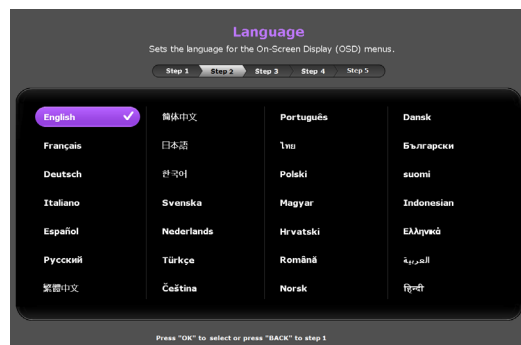

Step 3:

Specify **Vertical Keystone**.

 For more information about vertical keystone, see [Correcting keystone](#).

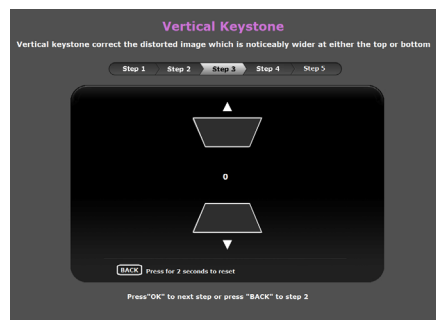

Step 4:
Specify **Auto Source**.

- ✎ Select **On** if you want the projector to always search for available signals automatically when the projector is turned on.



Step 5:
Specify **Menu Type**.

- ✎ For more information about menu types, see [Using the menus](#).

Now you've completed the initial setup.

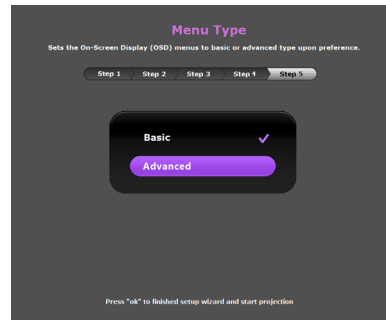

- If you are prompted for a password, press the arrow keys to enter a 6-digit password. See [Utilizing the password function on page 23](#).
- Switch all of the connected equipment on.
- The projector will search for input signals. The current input signal being scanned appears. If the projector does not detect a valid signal, the message “No Signal” will continue displaying until an input signal is found.
You can also press **SOURCE** to select your desired input signal. See [Switching input signal on page 25](#).

- ! Please use the original accessories (e.g. power cord) to avoid possible dangers such as electric shock and fire.
 - If the projector is still hot from previous activity, it will run the cooling fan for approximately 90 seconds before energizing the lamp.
-
- ✎ The Setup Wizard screenshots are for reference only and may differ from the actual design.
 - If the frequency/resolution of the input signal exceeds the projector's operating range, you will see the message “Out of Range” displayed on the background screen. Please change to an input signal which is compatible with the projector's resolution or set the input signal to a lower setting. See [Timing chart on page 47](#).
 - If no signal is detected for 3 minutes, the projector automatically enters saving mode.

Using the menus

The projector is equipped with 2 types of On-Screen Display (OSD) menus for making various adjustments and settings.

- **Basic** OSD menu: provides primary menu functions. (See [Basic menu on page 27](#))
- **Advanced** OSD menu: provides full menu functions. (See [Advanced menu on page 30](#))

To access the OSD menu, press **MENU** on the projector or remote control.

- Use the arrow keys (▲/▼/◀/▶) on the projector or remote control to move through the menu items.
- Use **OK** on the projector or remote control to confirm the selected menu item.

The first time you use the projector (after finishing the initial setup), Basic OSD menu displays.



The OSD screenshots below are for reference only, and may differ from the actual design.

Below is the overview of the **Basic** OSD menu.

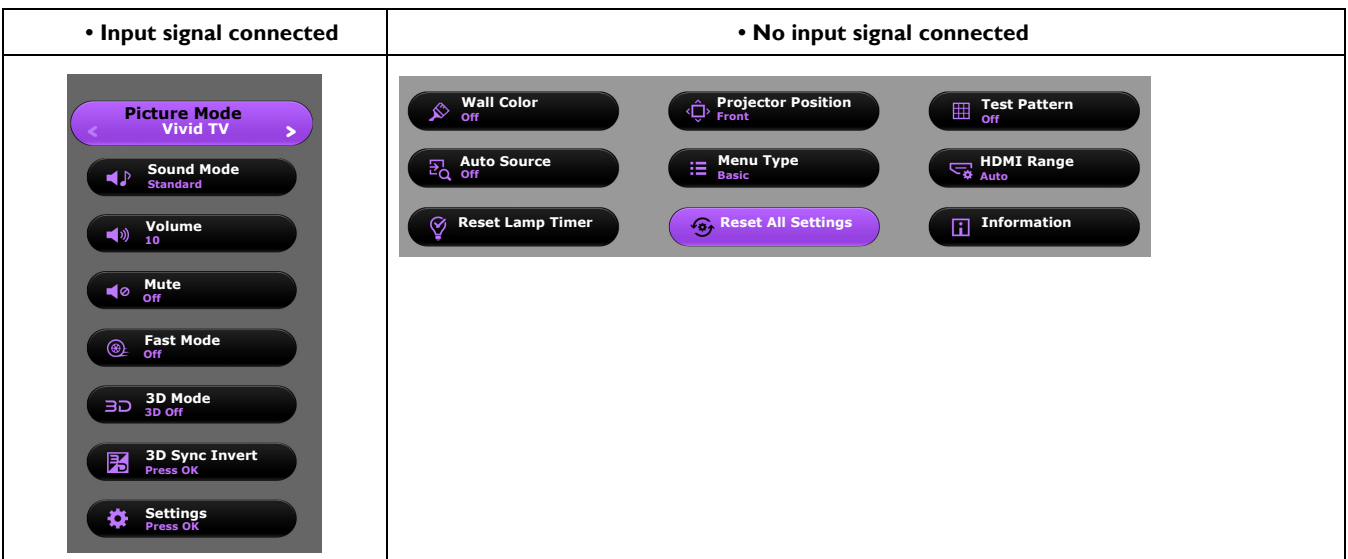

If you intend to switch from the **Basic** OSD menu to the **Advanced** OSD menu, follow the instructions below:

1. Go to **Basic Menu - Settings > Menu Type** and press **OK**.
2. Press **▲/▼** to select **Advanced** and press **OK**. Your projector will switch to **Advanced** OSD menu.

Below is the overview of the **Advanced** OSD menu.

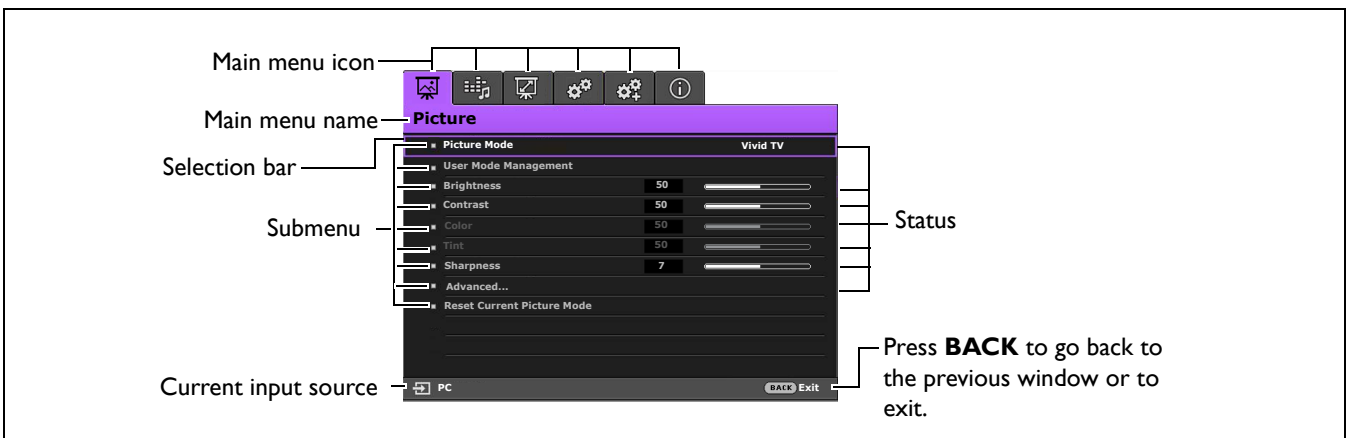

Likewise, when you wish to switch from the **Advanced** OSD menu to the **Basic** OSD menu, follow the instructions below:

1. Go to **Advanced Menu - System Setup : Basic > Menu Settings** and press **OK**.
2. Highlight **Menu Type** and press ◀/▶ to select **Basic**. Your projector will switch to the **Basic** OSD menu.

Securing the projector

Using a security cable lock

The projector has to be installed in a safe place to prevent theft. Otherwise, purchase a lock, such as the Kensington lock, to secure the projector. You can locate a Kensington lock slot on the rear side of the projector. See item 19 on [page 8](#).

A Kensington security cable lock is usually a combination of key(s) and the lock. Refer to the lock's documentation for finding out how to use it.

Utilizing the password function

Setting a password

1. Go to **Advanced Menu - System Setup : Advanced > Password**. Press **OK**. The **Password** page appears.
2. Highlight **Change Password** and press **OK**.
3. The four arrow keys (**▲**, **▶**, **▼**, **◀**) respectively represent 4 digits (1, 2, 3, 4). According to the password you desire to set, press the arrow keys to enter six digits for the password.
4. Confirm the new password by re-entering the new password. Once the password is set, the OSD menu returns to the **Password** page.
5. To activate the **Power On Lock** function, press **▲/▼** to highlight **Power On Lock** and press **◀/▶** to select **On**. Input the password again.

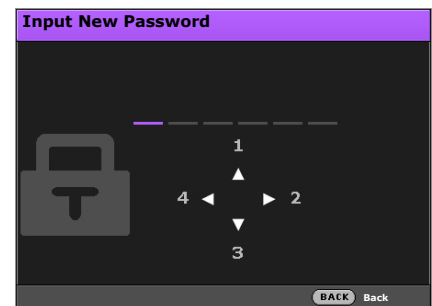

- The digits being input will display as asterisks on-screen. Make a note of your selected password and keep it in a safe place in advance or right after the password is entered so that it is available to you should you ever forget it.
- Once a password has been set and the power on lock is activated, the projector cannot be used unless the correct password is entered every time the projector is started.

If you forget the password

If you enter the wrong password, the password error message will appear, and the **Input Current Password** message follows. If you absolutely do not remember the password, you can use the password recall procedure. See [Entering the password recall procedure on page 24](#).

- Under the **Advanced OSD** menu

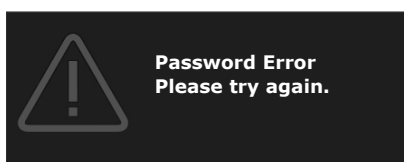

- Under the **Basic OSD** menu

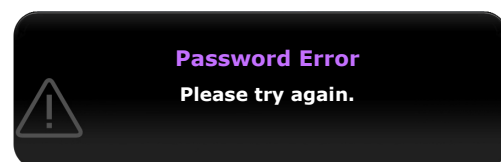

If you enter an incorrect password 5 times in succession, the projector will automatically shut down in a short time.

Entering the password recall procedure

1. Press and hold **AUTO** for 3 seconds. The projector will display a coded number on the screen.
 - Under the **Advanced OSD** menu
 - Under the **Basic OSD** menu

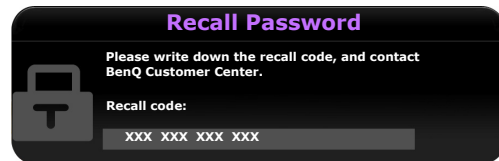
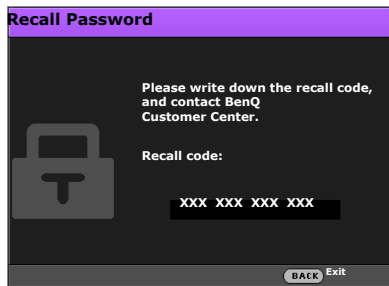

2. Write down the number and turn off your projector.
3. Seek help from the local BenQ service center to decode the number. You may be required to provide proof of purchase documentation to verify that you are an authorized user of the projector.

Changing the password

1. Go to **Advanced Menu - System Setup : Advanced > Password**. Press **OK**. The **Password** page appears.
2. Highlight **Change Password** and press **OK**. The message **“Input Current Password”** appears.
3. Enter the old password.
 - If the password is correct, another message **“Input New Password”** appears.
 - If the password is incorrect, the password error message will appear, and the message **“Input Current Password”** appears for your retry. You can press **BACK** to cancel the change or try another password.
4. Enter a new password.
5. Confirm the new password by re-entering the new password.

Disabling the password function

To disable password protection, go to **Advanced Menu - System Setup : Advanced > Password > Power On Lock** and press **◀/▶** to select **Off**. The message **“Input Current Password”** appears. Enter the current password.

- If the password is correct, the OSD menu returns to the **Security Settings** page. You will not have to enter the password next time turning on the projector.
- If the password is incorrect, the password error message will appear, and the message **“Input Current Password”** appears for your retry. You can press **BACK** to cancel the change or try another password.



Though the password function is disabled, you need to keep the old password in hand should you ever need to re-activate the password function by entering the old password.

Switching input signal

The projector can be connected to multiple devices at the same time. However, it can only display one full screen at a time. When starting up, the projector automatically searches for the available signals.

Be sure the **Advanced Menu - System Setup : Basic > Auto Source** menu is **On** if you want the projector to automatically search for the signals.

To select the source:



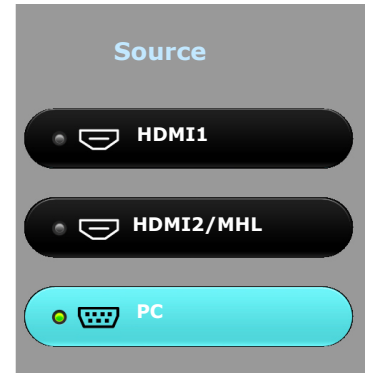

1. Press **SOURCE**. A source selection bar appears.
2. Press **▲/▼** until your desired signal is selected and press **OK**.

Once detected, the selected source information will appear at the corner of the screen for seconds. If there is multiple equipment connected to the projector, repeat steps 1-2 to search for another signal.



- The brightness level of the projected image will change accordingly when you switch between different input signals.
- For best display picture results, you should select and use an input signal which outputs at the projector's native resolution. Any other resolutions will be scaled by the projector depending upon the "aspect ratio" setting, which may cause some image distortion or loss of picture clarity. See [Aspect Ratio on page 34](#).

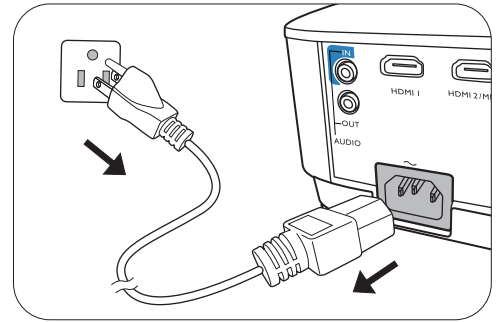

Shutting down the projector

1. Press  on the projector or  on the remote control and a confirmation message will appear prompting you. If you don't respond in a few seconds, the message will disappear.
2. Press  or  a second time. The power indicator flashes orange, the projection lamp shuts down, and the fans will continue to run for approximately 90 seconds to cool down the projector.
3. Once the cooling process finishes, the power indicator becomes a steady orange and fans stop. Disconnect the power cord from the power outlet.



- To protect the lamp, the projector will not respond to any commands during the cooling process.
- To shorten the cooling time, you can also activate the Quick cooling function. See [Quick Cooling on page 36](#).
- Avoid turning on the projector immediately after turning it off as excessive heat may shorten lamp life.
- Lamp life results will vary depending on environmental conditions and usage.

Direct power off

The AC power cord can be pulled out right after the projector is turned off. To protect the lamp, wait about 10 minutes before re-starting the projector. If you attempt to re-start the projector, the fans may run for a few minutes to cool down. In such cases, press  or  again to start the projector after the fans stop and the power indicator turns orange.





Menu operation

Please note that the on-screen display (OSD) menus vary according to the signal type selected and the projector model you are using.

The menu items are available when the projector detects at least one valid signal. If there is no equipment connected to the projector or no signal detected, limited menu items are accessible.

Basic menu

<p>Picture Mode</p>	<p>The projector is preset with several predefined picture modes so that you can choose one to suit your operating environment and input signal picture type.</p> <ul style="list-style-type: none"> • Bright: Maximizes the brightness of the projected image. This mode is suitable for environments where extra-high brightness is required, such as using the projector in well lit rooms. • Vivid TV: Being slightly brighter than Cinema mode, it is suitable for playing movies in rooms where there is a small amount of ambient light, eg. your living room. • Cinema: With well-balanced color saturation and contrast with a low brightness level, this is most suitable for enjoying movies in a totally dark environment (as you would find in a commercial cinema). • Sport: This mode is best for watching sporting events in rooms where is a small amount of ambient light, et. your living room. • Game: This mode is best for playing video games in rooms where there is a small amount of ambient light, eg. your living room. • User 1/User 2: Recalls the settings customized based on the current available picture modes. See User Mode Management on page 30.
<p>Sound Mode</p>	<p>Sound Mode function utilizes MaxxAudio sound enhancement technology, which incorporates Waves's algorithms to deliver great effects of the bass and treble and provide you with immersive cinematic audio experience. The following preset sound modes are provided: Standard, Cinema, Music, Game, Sport, and User.</p> <p> If the Mute function is activated, adjusting Sound Mode will turn off the Mute function.</p>
<p>Volume</p>	<p>Adjusts the sound level.</p>
<p>Mute</p>	<p>Temporarily turns off the sound.</p>
<p>Fast Mode</p>	<p>Select to turn On or Off the Fast Mode.</p>

<p>3D Mode</p>	<p>This projector supports playing three-dimensional (3D) content transferred through your 3D-compatible video devices and contents, such as PlayStation consoles (with 3D game discs), 3D Blu-ray players (with 3D Blu-ray discs), 3D TV (with 3D channel), and so on. After you have connected the 3D video devices to the projector, wear the BenQ 3D glasses and make sure the power is on to view 3D contents.</p> <ul style="list-style-type: none">  When watching 3D contents, <ul style="list-style-type: none"> • the image may seem misplaced, however, this is not a product malfunction. • take appropriate breaks when watching 3D content. • stop watching 3D content if you feel fatigue or discomfort. • keep a distance from the screen of about three times the effective height of the screen when watching 3D content. • children and people with a history of oversensitivity to light, heart problems, or have any other existing medical condition should be refrained from watching 3D content. <p>The default setting is Auto and the projector automatically chooses an appropriate 3D format when detecting 3D contents. If the projector cannot recognize the 3D format, manually choose a 3D mode according to your preference.</p> <ul style="list-style-type: none">  When this function is enabled: <ul style="list-style-type: none"> • The brightness level of the projected image decreases. • The Picture Mode cannot be adjusted. • The Vertical Keystone can only be adjusted within limited degrees.  The function is accessible through the remote control.
<p>3D Sync Invert</p>	<p>When your 3D image is distorted, enable this function to switch between the image for the left eye and the right eye for comfortable 3D viewing experience.</p> <ul style="list-style-type: none">  The function is accessible through the remote control.
<p>Settings</p>	<p>Press OK to enter its submenu.</p> <p>Press BACK to save your changes and exit.</p> <p>See below for more details.</p>
<ul style="list-style-type: none"> • Wall Color 	<p>Enable this function to help correct the projected picture's color when the projection surface is not white. You may choose a color similar to that of the projection surface from these options: Light Yellow, Pink, Light Green, or Blue.</p>
<ul style="list-style-type: none"> • Projector Position 	<p>The projector can be installed on a ceiling or behind a screen, or with one or more mirrors. See Choosing a location for details.</p>
<ul style="list-style-type: none"> • Test Pattern 	<p>Enable this function to display the grid test pattern, which helps you adjust the image size and focus so as to check if the projected image is free of distortion.</p>
<ul style="list-style-type: none"> • Auto Source 	<p>Sets whether the projector searches automatically for input sources. Select On to enable the projector to scan for input sources until it acquires a signal. If the function is set to Off, the projector selects the last used input source.</p>
<ul style="list-style-type: none"> • Menu Type 	<p>Switches to the Advanced OSD menu.</p>
<ul style="list-style-type: none"> • HDMI Range 	<p>Sets the HDMI Range to Auto, Full, or Limited.</p>

<ul style="list-style-type: none"> • Reset Lamp Timer 	<p>Activate this function only after a new lamp is installed. When you select Reset, a "Reset Successfully" message displays to notify that the lamp time has been reset to "0".</p>
<ul style="list-style-type: none"> • Reset All Settings 	<p>Returns all settings to the factory preset values.</p> <ul style="list-style-type: none"> • The following settings will still remain: Picture, Keystone, Language, Projector Position, Menu Type, Password, Key Lock, Reset Lamp Timer, and High Altitude Mode.
<ul style="list-style-type: none"> • Information 	<p>Displays the following information about your projector.</p> <ul style="list-style-type: none"> • Source: Displays the current signal source. • Picture Mode: Displays the current Picture Mode. • Resolution: Displays the native resolution of the input source. • Color System: Displays input system format. • Lamp Usage Time: Displays the number of hours the lamp has been used. • 3D Format: Displays the current 3D mode. • 3D Format is only available when 3D Mode is enabled. • Firmware Version: Displays the firmware version of your projector. • Some information is given only when certain input sources are in use.

Advanced menu

Picture

<p>Picture Mode</p>	<p>The projector is preset with several predefined picture modes so that you can choose one to suit your operating environment and input signal picture type.</p> <ul style="list-style-type: none"> • Bright: Maximizes the brightness of the projected image. This mode is suitable for environments where extra-high brightness is required, such as using the projector in well lit rooms. • Vivid TV: Being slightly brighter than Cinema mode, it is suitable for playing movies in rooms where there is a small amount of ambient light, eg. your living room. • Cinema: With well-balanced color saturation and contrast with a low brightness level, this is most suitable for enjoying movies in a totally dark environment (as you would find in a commercial cinema). • Sport: This mode is best for watching sporting events in rooms where is a small amount of ambient light, et. your living room. • Game: This mode is best for playing video games in rooms where there is a small amount of ambient light, eg. your living room. • User 1/User 2: Recalls the settings customized based on the current available picture modes. See User Mode Management on page 30.
<p>User Mode Management</p>	<p>There are 2 user-definable modes if the current available picture modes are not suitable for your need. You can use one of the picture modes (except the User 1/User 2) as a starting point and customize the settings.</p> <ol style="list-style-type: none"> 1. Go to Picture > Picture Mode. 2. Press ◀/▶ to select User 1 or User 2. 3. Press ▼ to highlight User Mode Management and press OK. 4. Highlight Load Settings From and press OK. 5. Press ▼ to select a picture mode that is close to your need. 6. When done, press OK and BACK to return to the Picture menu. 7. Press ▼ to select other submenus you want to make changes and use ◀/▶ to adjust the values. The adjustments define the selected user mode. <ul style="list-style-type: none"> • Rename User Mode <p>Select to rename the customized picture modes (User 1 or User 2).</p> <ol style="list-style-type: none"> 1. Go to the Picture > Picture Mode menu, select User 1 or User 2. 2. Press ▼ to select User Mode Management. 3. On the User Mode Management window, select Rename User Mode and press OK. 4. On the Rename User Mode window, use ▲/▼/◀/▶ to select desired characters for the selected mode. 5. When done, press OK and BACK to exit.
<p>Brightness</p>	<p>The higher the value, the brighter the image. Adjust this control so the black areas of the image appear just as black and that detail in the dark areas is visible.</p>

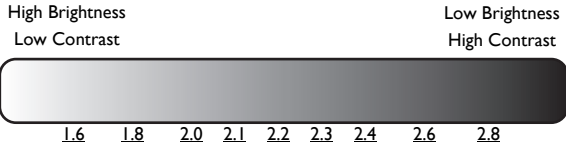
Contrast	The higher the value, the greater the contrast. Use this to set the peak white level after you have previously adjusted the Brightness setting to suit your selected input and viewing environment.
Color	Lower setting produces less saturated colors. If the setting is too high, colors on the image will be overpowering, which makes the image unrealistic.
Tint	The higher the value, the more greenish the picture becomes. The lower the value, the more reddish the picture becomes.
Sharpness	The higher the value, the sharper the picture becomes.
Advanced...	<p>Gamma Selection</p> <p>Gamma refers to the relationship between input source and picture brightness.</p> <ul style="list-style-type: none"> • 1.6/1.8/2.0/2.1: Select these values according to your preference. • 2.2/2.3: Increases the average brightness of the picture. Best for a lit environment, meeting room or family room. • 2.4: Best for viewing movies in a dark environment. • 2.6/2.8: Best for viewing movies which are mostly composed of dark scenes. <div style="text-align: center;">  </div>
	<p>Color Temperature</p> <p>There are several preset color temperature settings available. The available settings may vary according to the signal type selected.</p> <ul style="list-style-type: none"> • Lamp Native: With the lamp's original color temperature and higher brightness. This setting is suitable for environments where high brightness is required, such as projecting pictures in well lit rooms. • Warm: Makes images appear reddish white. • Normal: Maintains normal colorings for white. • Cool: Makes images appear bluish white.

Color Management

This function provides six sets (RGBCMY) of colors to be adjusted. When you select each color, you can independently adjust its range and saturation according to your preference.

- **Primary Color:** Selects a color from among **R** (Red), **G** (Green), **B** (Blue), **C** (Cyan), **M** (Magenta), or **Y** (Yellow).
- **Hue:** Increase in the range will include colors consisted of more proportions of its two adjacent colors. Please refer to the illustration for how the colors relate to each other. For example, if you select Red and set its range at 0, only pure red in the projected picture will be selected. Increasing its range will include red close to yellow and red close to magenta.
- **Saturation:** Adjusts the values to your preference. Every adjustment made will reflect to the image immediately. For example, if you select Red and set its value at 0, only the saturation of pure red will be affected.

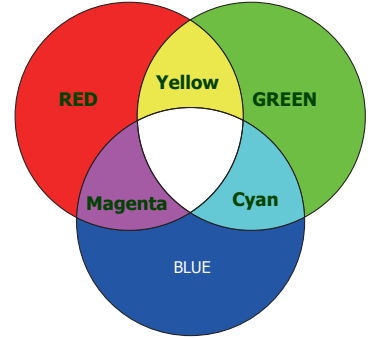

Saturation is the amount of that color in a video picture. Lower settings produce less saturated colors; a setting of “0” removes that color from the image entirely. If the saturation is too high, that color will be overpowering and unrealistic.

- **Gain:** Adjusts the values to your preference. The contrast level of the primary color you select will be affected. Every adjustment made will reflect to the image immediately.

Advanced...

Noise Reduction

Reduces electrical image noise caused by different media players. The higher the value, the less the noise.

Brilliant Color

This function utilizes a new color-processing algorithm and system level enhancements to enable higher brightness while providing truer, more vibrant colors in picture. It enables a greater than 50% brightness increase in mid-tone images, which are common in video and natural scenes, so the projector reproduces images in realistic and true colors. If you prefer images with that quality, select **On**. Selecting **Off** disables **Brilliant Color**, and **Color Temperature** becomes unavailable for access at the same time.

Fast Mode

Select to turn **On** or **Off** the **Fast Mode**.

Light Mode

Select the **Light Mode**. The options are **Normal**, **Economic**, **SmartEco**, and **LampSave**.

LumiExpert

This function adjusts the Gamma level automatically based on the ambient light detected through ALS. You can also manually adjust its value to your preference.



- **LumiExpert:** Select to turn **On** or **Off**.
- **Level:** With **LumiExpert** turned **On**, adjust the **Level** from -3 (dark) to 3 (bright).

Reset Current Picture Mode	Returns all of the adjustments you've made for the Picture menu to the factory preset values.
-----------------------------------	--

Audio Setup

Sound Mode	<p>Effect Mode</p> <p>Sound Mode function utilizes MaxxAudio sound enhancement technology, which incorporates Waves's algorithms to deliver great effects of the bass and treble and provide you with immersive cinematic audio experience. The following preset sound modes are provided: Standard, Cinema, Music, Game, Sport, and User. The User mode allows you to personalize the sound settings. When selecting the User mode, you may make manual adjustments with the User EQ function.</p> <p> If the Mute function is activated, adjusting Sound Mode will turn off the Mute function.</p> <p>User EQ</p> <p>Select desired frequency bands (100 Hz, 300 Hz, 1k Hz, 3k Hz, and 10k Hz) to adjust the levels according to your preference. The settings made here define the User mode.</p>
Mute	Temporarily turns off the sound.
Volume	Adjusts the sound level.
Power On/Off Ring Tone	Sets the ring tone for the projector On or Off .
Reset Audio Settings	All of the adjustments you've done under the Audio Setup menu return to the factory preset values.

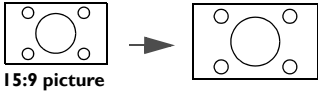
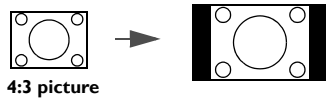
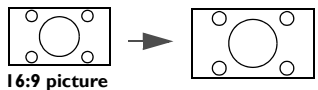
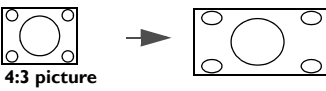
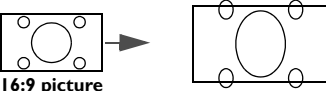
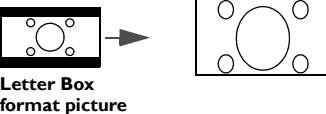
Display

<p>Aspect Ratio</p>	<p>There are several options to set the image's aspect ratio depending on your input signal source.</p> <ul style="list-style-type: none"> • Auto: Scales an image proportionally to fit the projector's native resolution in its horizontal or vertical width. • 4:3: Scales the picture so that it is displayed in the center of the screen with a 4:3 aspect ratio. • 16:9: Scales an image so that it is displayed in the center of the screen with a 16:9 aspect ratio. • Wide: Stretches a picture in a horizontal direction to fit the screen width. It does not alter the height of a picture. • Letter Box: Scales a picture to fit the projector's native resolution in its horizontal width and resizes the picture height to the 3/4 of the projection width. This makes a picture greater than the screen height. The top and bottom edges of the displayed picture are cropped. This suits the contents which are produced in letter box format (with black bars on the top and bottom).      
<p>Wall Color</p>	<p>Corrects the projected picture's color when the projection surface such as a painted wall which may not be white, the Wall Color feature can help correct the projected picture's colors to prevent possible color difference between the source and projected pictures. There are several precalibrated colors to choose from: Light Yellow, Pink, Light Green, and Blue.</p>
<p>Image Position</p>	<p>Displays the Image Position window. You may use the directional arrow keys on the projector or remote control to adjust the position of the projected picture.</p> <p>The values shown on the lower position of the window change with every key press you made.</p> <p> This function is only available when the PC signal is selected.</p>
<p>Overscan Adjustment</p>	<p>Conceals the poor picture quality in the four edges.</p> <p>The greater the value, the more portion of the picture is concealed while the screen remains filled and geometrically accurate. Setting 0 means the picture is 100% displayed.</p>
<p>PC & Component YPbPr Tuning</p>	<ul style="list-style-type: none"> • Phase: Adjusts the clock phase to reduce image distortion. This function is only available when a PC signal (analog RGB) or YPbPr signal is selected. • H. Size: Adjusts the horizontal width of the image. This function is only available when a PC signal (analog RGB) is selected. • Auto: Adjusts the phase and frequency automatically. 





3D	<p>This projector features a 3D function which enables you to enjoy the 3D movies, videos, and sporting events in a more realistic way by presenting the depth of the images. You need to wear a pair of 3D glasses to view the 3D images.</p> <ul style="list-style-type: none"> • 3D Mode: The default setting is Off. If you want the projector to automatically choose an appropriate 3D format when detecting 3D contents, select Auto. If the projector cannot recognize the 3D format, press ▲/▼ to choose a 3D mode from among Top Bottom, Frame Sequential, Frame Packing and Side by Side.  <p>When 3D function is activated:</p> <ul style="list-style-type: none"> • The brightness level of the projected image will decrease. • The following settings cannot be adjusted: Picture Mode, Reference Mode. • The Keystone can only be adjusted within limited degrees. • 3D Sync Invert: When you discover the inversion of the image depth, enable this function to correct the problem.
-----------	--

System Setup : Basic

Language	Sets the language for the On-Screen Display (OSD) menus.
Background Color	Sets the background color for the projector.
Splash Screen	Allows you to select which logo screen will be displayed during projector start-up.
Projector Position	See Choosing a location on page 12 .
Auto Off	Allows the projector to turn off automatically if no input signal is detected after a set period of time to prevent unnecessary waste of lamp life.
Direct Power On	Allows the projector to turn on automatically once the power is fed through the power cord.
Menu Settings	<ul style="list-style-type: none"> • Menu Type: Switches to the Basic OSD menu. • Menu Position: Sets the OSD menu position. • Menu Display Time: Sets the length of time the OSD will remain active after your last key press. • Blank Reminder Message: Sets whether the reminder message is displayed by the projector while the image is hidden.
Source Rename	<p>Renames the current input source to your desired name.</p> <p>On the Source Rename window, use ▲/▼/◀/▶ to set the desired characters for the connected source item.</p> <p>When done, press OK to save the changes.</p>
Auto Source	Allows the projector to automatically search for a signal.

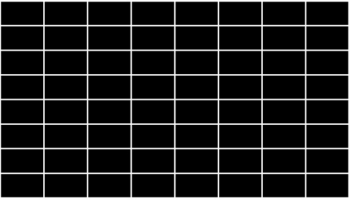
System Setup : Advanced

Lamp Settings	<ul style="list-style-type: none"> • Reset Lamp Timer: See Resetting the lamp timer on page 42. • Lamp Timer: Displays the number of hours the lamp has been used.
----------------------	--

HDMI Settings	<ul style="list-style-type: none"> • HDMI Range: Sets the HDMI Range to Auto, Full, or Limited.
Baud Rate	<p>Selects a baud rate that is identical with your computer's so that you can connect the projector using a suitable RS-232 cable and update or download the projector's firmware. This function is intended for qualified service personnel.</p>
Test Pattern	<p>Adjusts the image size and focus and check that the projected image is free from distortion.</p> 
Quick Cooling	<p>Select On enables the function and projector cooling time will be shortened from a normal 90-second duration to approximately 15 seconds.</p>
High Altitude Mode	<p>We recommend you use the High Altitude Mode when your environment is between 1500 m –3000 m above sea level, and ambient temperature is between 0°C–30°C.</p> <p>Operation under "High Altitude Mode" may cause a higher decibel operating noise level because of increased fan speed necessary to improve overall system cooling and performance.</p> <p>If you use this projector under other extreme conditions excluding the above, it may display auto shut-down symptoms, which is designed to protect your projector from over-heating. In cases like this, you should switch to High Altitude mode to solve these symptoms. However, this is not to state that this projector can operate under any and all harsh or extreme conditions.</p>  <p>Do not use the High Altitude Mode if your altitude is between 0 m and 1500 m and ambient temperature is between 0°C and 35°C. The projector will be over cooled, if you turn the mode on under such a condition.</p>
Password	<p>For security purposes and to prevent unauthorized use, you may set up password security for the projector. See Utilizing the password function for details.</p> <ul style="list-style-type: none"> • Change Password <p>You will be asked to enter the current password before changing to a new one.</p> <ul style="list-style-type: none"> • Power On Lock <p>Limits use of the projector to only those who know the correct password.</p>
Key Lock	<p>With the control keys on the projector locked, you can prevent your projector settings from being changed accidentally (by children, for example).</p> <p>When you select On to enable this function, no control keys on the projector will function, except  POWER.</p> <p>To unlock the keys, press and hold  on the projector for 3 seconds.</p>

LED Indicator	<p>When you select On, all LED indicators on the projector function normally. See Indicators for more details.</p> <p>When you select Off, the LED indicators are off after you turn on the projector and the splash screen displays. However, if the projector is not working properly, the LED indicators light or flash to remind you that a problem may occur. See also Indicators for more details.</p>
Reset All Settings	<p>Returns all settings to the factory preset values.</p> <p> The following settings will still remain: Picture, Keystone, Language, Projector Position, Menu Type, Password, Key Lock, Reset Lamp Timer, and High Altitude Mode.</p>

Information

Information	<ul style="list-style-type: none"> • Source: Shows the current signal source. • Picture Mode: Shows the selected mode in the Picture menu. • Resolution: Displays the native resolution of the input source. • Color System: Shows input system format. • Lamp Usage Time: Shows the number of hours the lamp has been used. • 3D Format: Shows the current 3D mode. • Firmware Version: Shows the firmware version of your projector.
--------------------	---

Maintenance

Care of the projector

Cleaning the lens

Clean the lens whenever you notice dirt or dust on the surface. Please be sure to turn off the projector and let it cool down completely before cleaning the lens.

- Use a canister of compressed air to remove dust.
- If there is dirt or smears, use lens-cleaning paper or moisten a soft cloth with lens cleaner and gently wipe the lens surface.
- Never use any type of abrasive pad, alkaline/acid cleaner, scouring powder, or volatile solvent, such as alcohol, benzene, thinner or insecticide. Using such materials or maintaining prolonged contact with rubber or vinyl materials may result in damage to the projector surface and cabinet material.

Cleaning the projector case

Before you clean the case, turn the projector off using the proper shutdown procedure as described in [Shutting down the projector on page 26](#) and unplug the power cord.

- To remove dirt or dust, wipe the case with a soft, lint-free cloth.
- To remove stubborn dirt or stains, moisten a soft cloth with water and a neutral pH detergent. Then wipe the case.



Never use wax, alcohol, benzene, thinner or other chemical detergents. These can damage the case.

Storing the projector

If you need to store the projector for an extended time, please follow the instructions below:

- Make sure the temperature and humidity of the storage area are within the recommended range for the projector. Please refer to [Specifications on page 45](#) or consult your dealer about the range.
- Retract the adjuster feet.
- Remove the battery from the remote control.
- Pack the projector in its original packing or equivalent.

Transporting the projector

It is recommended that you ship the projector with its original packing or equivalent.

Lamp information

Getting to know the lamp hour

When the projector is in operation, the duration (in hours) of lamp usage is automatically calculated by the built-in timer. The method of calculating the equivalent lamp hour is as follows:

Lamp Usage Time = (hours used in **Normal** mode) + (hours used in **Economic** mode) + (hours used in **SmartEco** mode) + (hours used in **LampSave** mode)

Total (equivalent) lamp hour = 3.75 x (hours used in **Normal** mode) + 1.5 x (hours used in **Economic** mode) + 1.5 x (hours used in **SmartEco** mode) + 1 x (hours used in **LampSave** mode)

To obtain the lamp hour information:

1. Go to **Advanced Menu - System Setup : Advanced > Lamp Settings** and press **OK**. The **Lamp Settings** page appears.
2. Press **▼** to select **Lamp Timer** and press **OK**. The **Lamp Timer** information is displayed.

You can also get the lamp hour information on the **Information** menu.

Extending lamp life

• Setting the **Light Mode**

1. Go to **Advanced Menu - Picture > Advanced... > Light Mode**, press **OK**. The **Lamp Power** page appears.
2. Select a suitable lamp power from the provided modes.

Setting the projector in **Economic**, **SmartEco** or **LampSave** mode extends lamp life.

Lamp mode	Description
Normal	Provides full lamp brightness
Economic	Lowers brightness to extend the lamp life and decreases the fan noise
SmartEco	Adjusts the lamp power automatically depending on the content brightness level while optimizing display quality
LampSave	Adjusts the lamp power automatically depending on the content brightness level while offering a longer lamp life

• Setting **Auto Off**

This function allows the projector to turn off automatically if no input signal is detected after a set period of time to prevent unnecessary waste of lamp life.

To set **Auto Off**, go to **Advanced Menu - System Setup : Basic > Auto Off** and press **◀/▶**.

Timing of replacing the lamp

When the **Lamp indicator** lights up or a message appears suggesting it is time to replace the lamp, please consult your dealer or go to <http://www.BenQ.com> before installing a new lamp. An old lamp may cause a malfunction in the projector and in some instances the lamp may explode.



- The apparent brightness of the projected image will vary depending on the ambient lighting conditions, selected input signal contrast/brightness settings, and is directly proportional to projection distance.
- The lamp brightness will decline over time and may vary within the lamp manufacturers specifications. This is normal and expected behavior.
- The **LAMP indicator light** and **TEMPerature warning light** will light up if the lamp becomes too hot. Turn the power off and let the projector cool for 45 minutes. If the Lamp or Temp indicator still lights up after turning the power back on, please contact your dealer. See [Indicators on page 43](#).

The following Lamp warning displays will remind you to change the lamp.

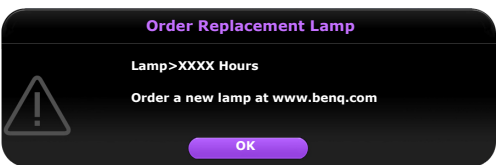
	<p>Install a new lamp for optimal performance. Press OK to dismiss the message.</p>
---	--

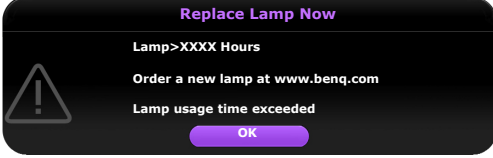
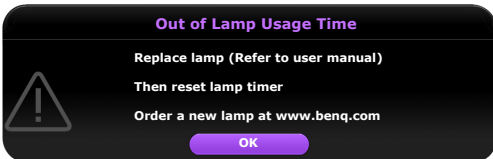
 <p>Replace Lamp Soon Lamp>XXXX Hours Order a new lamp at www.benq.com OK</p>	<p>It is strongly recommended that you replace the lamp at this age. The lamp is a consumable item. The lamp brightness diminishes with use. This is normal lamp behavior. You can replace the lamp whenever you notice that the brightness level has significantly diminished. Press OK to dismiss the message.</p>
 <p>Replace Lamp Now Lamp>XXXX Hours Order a new lamp at www.benq.com Lamp usage time exceeded OK</p>  <p>Out of Lamp Usage Time Replace lamp (Refer to user manual) Then reset lamp timer Order a new lamp at www.benq.com OK</p>	<p>The lamp MUST be replaced before the projector will operate normally. Press OK to dismiss the message.</p>



"XXXX" shown in the above messages are numbers that vary depending on different models.

Replacing the lamp



- To reduce the risk of electrical shock, always turn the projector off and disconnect the power cord before changing the lamp.
 - To reduce the risk of severe burns, allow the projector to cool for at least 45 minutes before replacing the lamp.
 - To reduce the risk of injuries to fingers and damage to internal components, use caution when removing lamp glass that has shattered into sharp pieces.
 - To reduce the risk of injuries to fingers and/or compromising image quality by touching the lens, do not touch the empty lamp compartment when the lamp is removed.
 - This lamp contains mercury. Consult your local hazardous waste regulations to dispose of this lamp in a proper manner.
 - To assure optimal performance from the projector, it is recommended that you purchase a qualified projector lamp for lamp replacement.
 - If lamp replacement is performed while the projector is suspended upside-down, make sure that no one is underneath the lamp socket to avoid any possible injury or damage to the human eyes caused by fractured lamp.
 - Ensure good ventilation when handling broken lamps. We recommend that you use respirators, safety glasses, goggles or face shield and wear protective clothing such as gloves.
1. Turn the power off and disconnect the projector from the power outlet. If the lamp is hot, avoid burns by waiting for approximately 45 minutes until the lamp has cooled.
 2. Loosen the screw(s) that secure the lamp cover on the side of the projector until the lamp cover loosens.

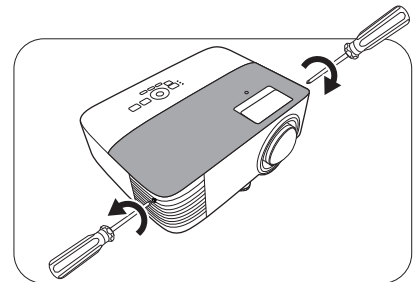

3. Remove the lamp cover from the projector.



- Do not turn the power on with the lamp cover open.
- Do not insert your fingers between the lamp and the projector. The sharp edges inside the projector may cause injuries

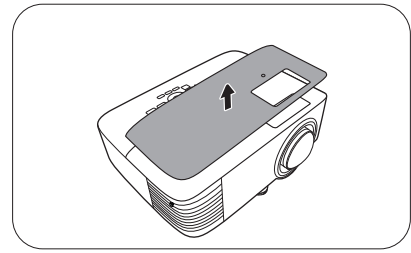

4. Disconnect the lamp connector.

5. Loosen the screw(s) that secure the inner lamp.

6. Lift the handle so that it stands up.

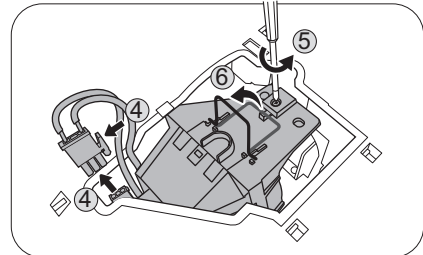

7. Use the handle to slowly pull the lamp out of the projector.



- Pulling it too quickly may cause the lamp to break and scatter broken glass in the projector.
- Do not place the lamp in locations where water might splash on it, children can reach it, or near flammable materials.
- Do not insert your hands into the projector after the lamp is removed. The sharp edges inside the projector may cause injuries. If you touch the optical components inside, it could cause color unevenness and distortion of the projected images.

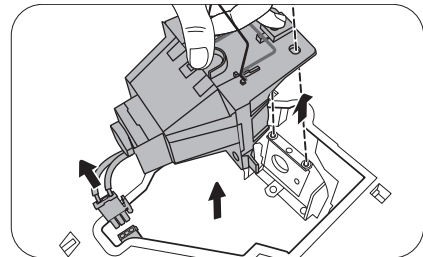

8. As shown in the figure, insert the new lamp. Align the lamp connector and 2 sharp points with the projector and push the lamp a bit into the locked position.

9. Insert the lamp connector.

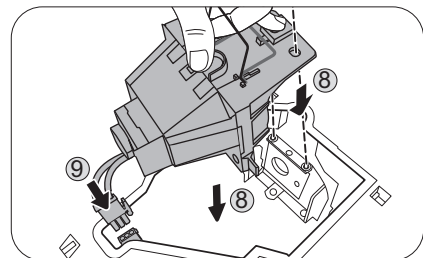

10. Tighten the screw(s) that secures the lamp.

11. Ensure the handle is fully laid flat and locked in place.



- Loose screw may cause a bad connection, which could result in malfunction.
- Do not over tighten the screw.

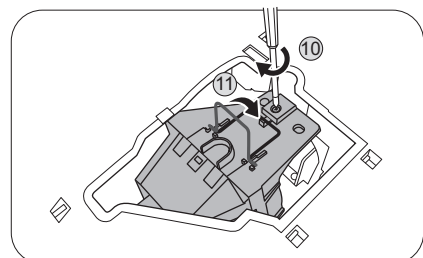

12. Replace the lamp cover on the projector.

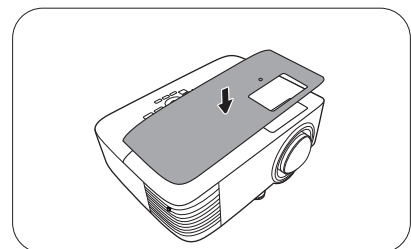

13. Tighten the screw that secures the lamp cover.



- Loose screw may cause a bad connection, which could result in malfunction.
- Do not over tighten the screw.

14. .Connect the power and restart the projector.

Resetting the lamp timer

15. After the startup logo, open the On-Screen Display







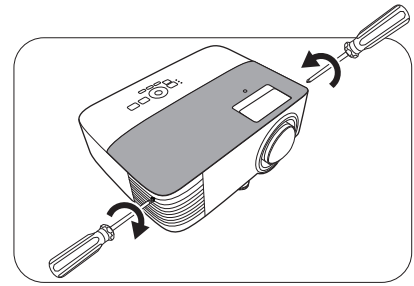



































(OSD) menu. Go to **Advanced Menu - System Setup : Advanced > Lamp Settings** and press **OK**. The **Lamp Settings** page appears. Highlight **Reset Lamp Timer** and press **OK**. A warning message is displayed asking if you want to reset the lamp timer. Highlight **Reset** and press **OK**. The lamp time will be reset to “0”.











- Do not reset if the lamp is not new or replaced as this could cause damage.



Indicators

Light			Status & Description
POWER ○	TEMP ○	LAMP ○	
Power events			
			Stand-by mode
			Powering up
			Normal operation
			Normal power-down cooling
			Download
			CW start fail
			Scaler Shutdown Fail
Burn-In events			
			Burn-in ON
			Burn-in OFF
Lamp events			
			Lamp error in normal operation
			Lamp is not lit up
Thermal events			
			Fan 1 error (the actual fan speed is outside the desired speed)
			Fan 2 error (the actual fan speed is outside the desired speed)
			Temperature 1 error (over limited temperature)

	 : Off	 : Orange On	 : Green On	 : Red On
		 : Orange Flashing	 : Green Flashing	 : Red Flashing

Troubleshooting

? The projector does not turn on.

Cause	Remedy
There is no power from the power cord.	Plug the power cord into the AC power jack on the projector, and plug the power cord into the power outlet. If the power outlet has a switch, make sure that it is switched on.
Attempting to turn the projector on again during the cooling process.	Wait until the cooling down process has completed.

? No picture

Cause	Remedy
The video source is not turned on or connected correctly.	Turn the video source on and check that the signal cable is connected correctly.
The projector is not correctly connected to the input signal device.	Check the connection.
The input signal has not been correctly selected.	Select the correct input signal with the SOURCE key.
The lens cover is still closed.	Open the lens cover.

? Blurred image

Cause	Remedy
The projection lens is not correctly focused.	Adjust the focus of the lens using the focus ring.
The projector and the screen are not aligned properly.	Adjust the projection angle and direction as well as the height of the projector if necessary.
The lens cover is still closed.	Open the lens cover.

? Remote control does not work.

Cause	Remedy
The batteries are out of power.	Replace both of the batteries with new ones.
There is an obstacle between the remote control and the projector.	Remove the obstacle.
You are too far away from the projector.	Stand within 8 meters (26 feet) of the projector.

? The password is incorrect.

Cause	Remedy
You do not remember the password.	See Entering the password recall procedure on page 24 .

Specifications

Projector specifications



All specifications are subject to change without notice.

Optical

Resolution

1920 (H) x 1080 (V)

Display system

1-CHIP DMD

Lens

F = 2.6 ~ 2.78, f = 10.2 ~ 12.24 mm

Lamp

240 W lamp

Electrical

Power supply

AC100–240V, 3.5 A, 50–60 Hz (Automatic)

Power consumption

320 W (Max); < 0.5 W (Standby)

Mechanical

Weight

2.7 Kg (5.95 lbs)

Output terminals

RGB output

D-Sub 15-pin (female) x 1

Speaker

5 watt x 1

Audio signal output

PC audio jack x 1

Control

USB

Type-A power supply 5V /1.0 A x 1 (Optional for QCast Mirror HDMI Wireless Dongle); Mini-B x 1

RS-232 serial control

9 pin x 1

IR receiver x 2

Input terminals

Computer input

RGB input

D-Sub 15-pin (female) x 1

Video signal input

SD/HDTV signal input

Digital - HDMI x 1;

HDMI/MHL x 1

Audio signal input

Audio in

PC audio jack x 1

Environmental Requirements

Operating temperature

0°C–40°C at sea level

Operating relative humidity

10%–90% (without condensation)

Operating altitude

0–1499 m at 0°C–35°C

1500–3000 m at 0°C–30°C (with

High Altitude Mode on)

Storage temperature

-20°C–60°C at sea level

Storage humidity

10%–90% RH (without condensation)

Storage altitude

30°C@ 0~12,200m above sea level

Transporting

Original packing or equivalent is recommended

Repairing

Please visit below website and choose your country to find your service contact window.

<http://www.benq.com/welcome>

Dimensions

296 mm (W) x 120 mm (H) x 224 mm (D)

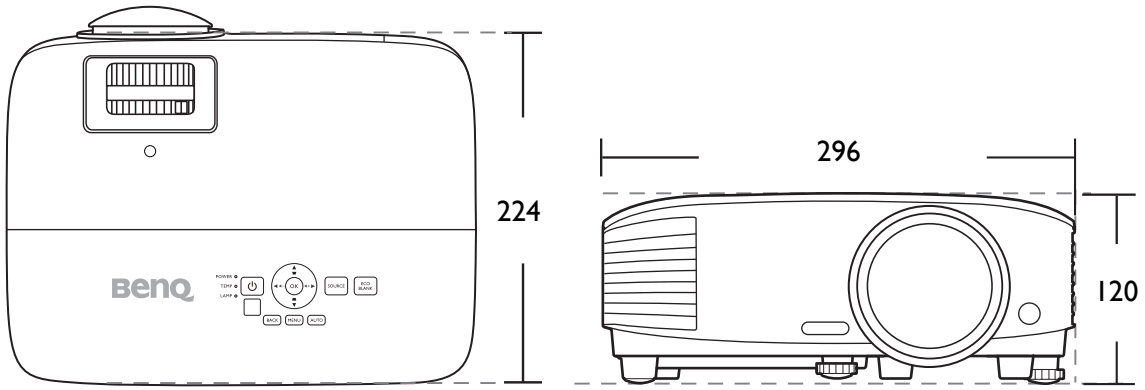

Unit: mm

Timing chart

Supported timing for PC input

Resolution	Mode	Vertical Frequency (Hz)	Horizontal Frequency (kHz)	Pixel Frequency (MHz)	Supported 3D format		
					Frame Sequential	Top Bottom	Side by Side
640 x 480	VGA_60	59.940	31.469	25.175	V	V	V
	VGA_72	72.809	37.861	31.500			
	VGA_75	75.000	37.500	31.500			
	VGA_85	85.008	43.269	36.000			
720 x 400	720 x 400_70	70.087	31.469	28.3221			
800 x 600	SVGA_60	60.317	37.879	40.000	V	V	V
	SVGA_72	72.188	48.077	50.000			
	SVGA_75	75.000	46.875	49.500			
	SVGA_85	85.061	53.674	56.250			
	SVGA_120 (Reduce Blanking)	119.854	77.425	83.000	V		
1024 x 768	XGA_60	60.004	48.363	65.000	V	V	V
	XGA_70	70.069	56.476	75.000			
	XGA_75	75.029	60.023	78.750			
	XGA_85	84.997	68.667	94.500			
	XGA_120 (Reduce Blanking)	119.989	97.551	115.5	V		
1152 x 864	1152 x 864_75	75	67.5	108			
1024 x 576	BenQ Notebook_timing	60.0	35.820	46.966			
1024 x 600	BenQ Notebook_timing	64.995	41.467	51.419			
1280 x 720	1280 x 720_60	60	45.000	74.250	V	V	V
1280 x 768	1280 x 768_60	59.87	47.776	79.5	V	V	V
1280 x 800	WXGA_60	59.810	49.702	83.500	V	V	V
	WXGA_75	74.934	62.795	106.500			
	WXGA_85	84.880	71.554	122.500			
	WXGA_120 (Reduce Blanking)	119.909	101.563	146.25	V		
1280 x 1024	SXGA_60	60.020	63.981	108.000		V	V
	SXGA_75	75.025	79.976	135.000			
	SXGA_85	85.024	91.146	157.500			
1280 x 960	1280 x 960_60	60.000	60.000	108.000		V	V
	1280 x 960_85	85.002	85.938	148.500			
1360 x 768	1360 x 768_60	60.015	47.712	85.5		V	V
1440 x 900	WXGA+_60	59.887	55.935	106.500		V	V
1400 x 1050	SXGA+_60	59.978	65.317	121.750		V	V
1600 x 1200	UXGA	60.000	75.000	162.000		V	V
1680 x 1050	1680 x 1050_60	59.954	65.290	146.250		V	V
640 x 480@67Hz	MAC13	66.667	35.000	30.240			
832 x 624@75Hz	MAC16	74.546	49.722	57.280			
1024 x 768@75Hz	MAC19	74.93	60.241	80.000			
1152 x 870@75Hz	MAC21	75.060	68.680	100.000			
1920 x 1200	1920 x 1200_60 (Reduce Blanking)	59.950	74.038	154.0000		V	V



The timings showing above may not be supported due to EDID file and VGA graphic card limitations. It is possible that some timings cannot be chosen.

Supported timing for HDMI (HDCP) input

- PC timings

Resolution	Mode	Vertical Frequency (Hz)	Horizontal Frequency (kHz)	Pixel Frequency (MHz)	Supported 3D format		
					Frame Sequential	Top Bottom	Side by Side
640 x 480	VGA_60	59.940	31.469	25.175	V	V	V
	VGA_72	72.809	37.861	31.500			
	VGA_75	75.000	37.500	31.500			
	VGA_85	85.008	43.269	36.000			
720 x 400	720 x 400_70	70.087	31.469	28.3221			
800 x 600	SVGA_60	60.317	37.879	40.000	V	V	V
	SVGA_72	72.188	48.077	50.000			
	SVGA_75	75.000	46.875	49.500			
	SVGA_85	85.061	53.674	56.250			
1024 x 768	SVGA_120 (Reduce Blanking)	119.854	77.425	83.000	V		
	XGA_60	60.004	48.363	65.000	V	V	V
	XGA_70	70.069	56.476	75.000			
	XGA_75	75.029	60.023	78.750			
1152 x 864	XGA_85	84.997	68.667	94.500			
	XGA_120 (Reduce Blanking)	119.989	97.551	115.5	V		
1152 x 864	1152 x 864_75	75	67.5	108			
1024 x 576@60Hz	BenQ Notebook Timing	60.00	35.820	46.996			
1024 x 600@65Hz	BenQ Notebook Timing	64.995	41.467	51.419			
1280 x 720	1280 x 720_60	60	45.000	74.250	V	V	V
1280 x 768	1280 x 768_60	59.870	47.776	79.5	V	V	V
1280 x 800	WXGA_60	59.810	49.702	83.500	V	V	V
	WXGA_75	74.934	62.795	106.500			
	WXGA_85	84.880	71.554	122.500			
	WXGA_120 (Reduce Blanking)	119.909	101.563	146.25	V		
1280 x 1024	SXGA_60	60.020	63.981	108.000		V	V
	SXGA_75	75.025	79.976	135.000			
	SXGA_85	85.024	91.146	157.500			
1280 x 960	1280 x 960_60	60.000	60.000	108		V	V
	1280 x 960_85	85.002	85.938	148.500			
1360 x 768	1360 x 768_60	60.015	47.712	85.500		V	V
1440 x 900	WXGA+_60	59.887	55.935	106.500		V	V
1400 x 1050	SXGA+_60	59.978	65.317	121.750		V	V
1600 x 1200	UXGA	60.000	75.000	162.000		V	V
1680 x 1050	1680 x 1050_60	59.954	65.290	146.250		V	V
640 x 480@67Hz	MAC13	66.667	35.000	30.240			
832 x 624@75Hz	MAC16	74.546	49.722	57.280			
1024 x 768@75Hz	MAC19	75.020	60.241	80.000			
1152 x 870@75Hz	MAC21	75.06	68.68	100.00			
1920 x 1080@60Hz	1920 x 1080_60	60	67.5	148.5		V	V
1920 x 1200	1920 x 1200_60 (Reduce Blanking)	59.950	74.038	154.0000		V	V



The timings showing above may not be supported due to EDID file and VGA graphic card limitations. It is possible that some timings cannot be chosen.

- Video timings

Timing	Resolution	Vertical Frequency (Hz)	Horizontal Frequency (kHz)	Pixel Frequency (MHz)	Supported 3D format			
					Frame Sequential	Frame Packing	Top Bottom	Side by Side
480i	720 x 480	59.94	15.73	27	V			
480p	720 x 480	59.94	31.47	27	V			
576i	720 x 576	50	15.63	27				
576p	720 x 576	50	31.25	27				
720/50p	1280 x 720	50	37.5	74.25		V	V	V
720/60p	1280 x 720	60	45.00	74.25	V	V	V	V
1080/50i	1920 x 1080	50	28.13	74.25				V
1080/60i	1920 x 1080	60	33.75	74.25				V
1080/24P	1920 x 1080	24	27	74.25		V	V	V
1080/25P	1920 x 1080	25	28.13	74.25				
1080/30P	1920 x 1080	30	33.75	74.25				
1080/50P	1920 x 1080	50	56.25	148.5			V	V
1080/60P	1920 x 1080	60	67.5	148.5			V	V

Supported timing for MHL input

Timing	Resolution	Vertical Frequency (Hz)	Horizontal Frequency (kHz)	Pixel Frequency (MHz)
480i	720 (1440) x 480	59.94	15.73	27
480p	720 x 480	59.94	31.47	27
576i	720 (1440) x 576	50	15.63	27
576p	720 x 576	50	31.25	27
720/50p	1280 x 720	50	37.5	74.25
720/60p	1280 x 720	60	45.00	74.25
1080/24P	1920 x 1080	24	27	74.25
1080/25P	1920 x 1080	25	28.13	74.25
1080/30P	1920 x 1080	30	33.75	74.25
1080/50i	1920 x 1080	50	28.13	74.25
1080/60i	1920 x 1080	60	33.75	74.25
1080/50p	1920 x 1080	50	56.25	148.5
1080/60p	1920 x 1080	60	67.5	148.5