



Digital Projector User Manual

Warranty and Copyright information

Limited warranty

BenQ warrants this product against any defects in material and workmanship, under normal usage and storage.

Proof of purchase date will be required with any warranty claim. In the event this product is found to be defective within the warranty period, BenQ's only obligation and your exclusive remedy shall be replacement of any defective parts (labor included). To obtain warranty service, immediately notify the dealer from which you purchased the product of any defects.

Important: The above warranty shall be void if the customer fails to operate the product in accordance with BenQ's written instructions, especially the ambient humidity must be in-between 10% and 90%, temperature in-between 0°C and 35°C, altitude lower than 4920 feet, and avoiding to operate the projector in a dusty environment. This warranty gives you specific legal rights, and you may have other rights which vary from country to country.

For other information, please visit www.BenQ.com.

Copyright

Copyright © 2019 by BenQ Corporation. All rights reserved. No part of this publication may be reproduced, transmitted, transcribed, stored in a retrieval system or translated into any language or computer language, in any form or by any means, electronic, mechanical, magnetic, optical, chemical, manual or otherwise, without the prior written permission of BenQ Corporation.

Disclaimer

BenQ Corporation makes no representations or warranties, either expressed or implied, with respect to the contents hereof and specifically disclaims any warranties, merchantability or fitness for any particular purpose. Further, BenQ Corporation reserves the right to revise this publication and to make changes from time to time in the contents hereof without obligation to notify any person of such revision or changes.

*DLP, Digital Micromirror Device and DMD are trademarks of Texas Instruments. Others are copyrights of their respective companies or organizations.

Patents

Please go to <http://patmarking.benq.com/> for the details on BenQ projector patent coverage.

Table of Contents

Warranty and Copyright information	2
Important safety instructions	4
Introduction	7
Shipping contents	7
Projector exterior view	8
Controls and functions.....	9
Positioning your projector	11
Choosing a location	11
Obtaining a preferred projected image size.....	12
Shifting the projection lens	13
Mounting the projector	13
Adjusting the projected image.....	15
Connection	16
Operation	17
Starting up the projector	17
Using the menus	19
Upgrading firmware	19
Securing the projector	19
Switching input signal	21
Presenting from a Media Reader.....	22
Shutting down the projector	22
Direct power off	22
Menu operation	23
PICTURE menu	23
DISPLAY menu.....	27
INSTALLATION menu.....	28
SYSTEM SETUP: BASIC menu.....	29
SYSTEM SETUP: ADVANCED menu	30
INFORMATION menu	31
Maintenance	32
Care of the projector	32
Lamp information	32
Troubleshooting	38
Specifications	39
Projector specifications	39
Dimensions	40
Timing chart.....	41

Important safety instructions

Your projector is designed and tested to meet the latest standards for safety of information technology equipment. However, to ensure safe use of this product, it is important that you follow the instructions mentioned in this manual and marked on the product.

1. **Please read this manual before you operate your projector.** Save it for future reference.



2. **Do not look straight at the projector lens during operation.** The intense light beam may damage your eyes.



3. **Refer servicing to qualified service personnel.**

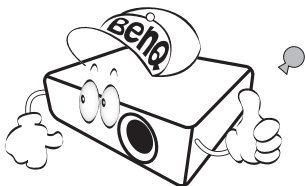

4. **Always open the lens shutter (if any) or remove the lens cap (if any) when the projector lamp is on.**

5. The lamp becomes extremely hot during operation. Allow the projector to cool for approximately 45 minutes prior to removing the lamp assembly for replacement.



6. In some countries, the line voltage is NOT stable. This projector is designed to operate safely within a mains voltage between 100 to 240 volts AC, but could fail if power cuts or surges of ± 10 volts occur. **In areas where the mains voltage may fluctuate or cut out, it is recommended that you connect your projector through a power stabilizer, surge protector or uninterruptible power supply (UPS).**

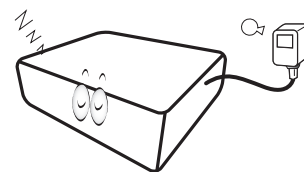

7. Do not block the projection lens with any objects when the projector is under operation as this could cause the objects to become heated and deformed or even cause a fire. To temporarily turn off the lamp, use the blank function.



8. Do not operate lamps beyond the rated lamp life. Excessive operation of lamps beyond the rated life could cause them to break on rare occasions.



9. Never replace the lamp assembly or any electronic components unless the projector is unplugged.



10. Do not place this product on an unstable cart, stand, or table. The product may fall, sustaining serious damage.

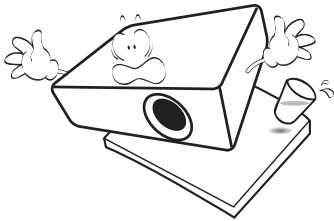

11. Do not attempt to disassemble this projector. There are dangerous high voltages inside which may cause death if you should come into contact with live parts. The only user serviceable part is the lamp which has its own removable cover.

Under no circumstances should you ever undo or remove any other covers. Refer servicing only to suitably qualified professional service personnel.

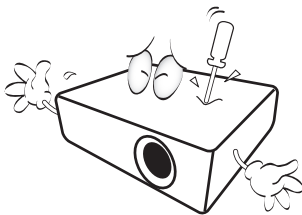

12. Do not block the ventilation holes.

- Do not place this projector on a blanket, bedding or any other soft surface.
- Do not cover this projector with a cloth or any other item.
- Do not place inflammables near the projector.

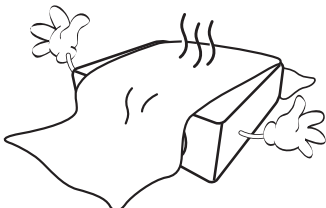

If the ventilation holes are seriously obstructed, overheating inside the projector may result in a fire.

13. Always place the projector on a level, horizontal surface during operation.

- Do not use if tilted at an angle of more than 10 degrees left to right, nor at angle of more than 15 degrees front to back. Using the projector when it is not fully horizontal may cause a malfunction of, or damage to, the lamp.



14. Do not stand the projector on end vertically. Doing so may cause the projector to fall over, causing injury or resulting in damage to the projector.



15. Do not step on the projector or place any objects upon it. Besides probable physical damage to the projector, doing so may result in accidents and possible injury.

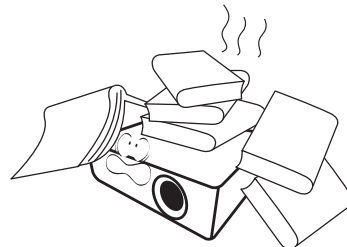

16. When the projector is under operation, you may sense some heated air and odor from its ventilation grill. It is a normal phenomenon and not a product defect.

17. Do not place liquids near or on the projector. Liquids spilled into the projector may cause it to fail. If the projector does become wet, disconnect it from the power supply's power outlet and call BenQ to have the projector serviced.

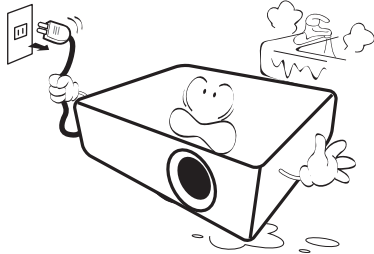

18. This product is capable of displaying inverted images for ceiling/wall mount installation.

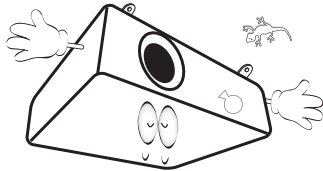

19. This apparatus must be earthed.



- Hg - Lamp contains mercury. Manage in accordance with local disposal laws. See www.lamprecycle.org.
- To avoid damaging the DLP chips, never aim a high-power laser beam into the projection lens.

20. Do not place this projector in any of the following environments.

- Space that is poorly ventilated or confined. Allow at least 50 cm clearance from walls and free flow of air around the projector.
- Locations where temperatures may become excessively high, such as the inside of a car with all windows rolled up.
- Locations where excessive humidity, dust, or cigarette smoke may contaminate optical components, shorten the projector's life span and darken the image.

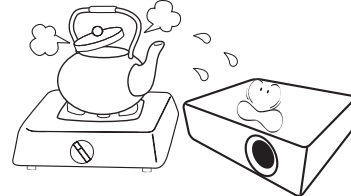

- Locations near fire alarms
- Locations with an ambient temperature above 40°C / 104°F
- Locations where the altitudes are higher than 3000 m (10000 feet).

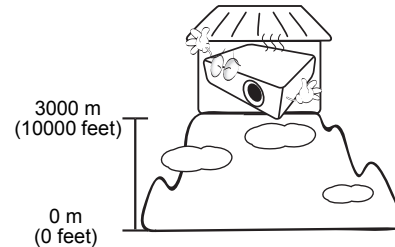

Introduction

Shipping contents

Carefully unpack and verify that you have all of the items shown below. If any of these items are missing, please contact your place of purchase.

Standard accessories

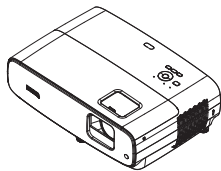

Projector

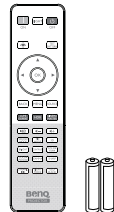

Remote control with batteries



User manual CD



Quick start guide



Warranty card*

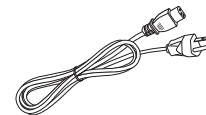

Power cord



• The supplied accessories will be suitable for your region, and may differ from those illustrated.

• *The warranty card is only supplied in some specific regions. Please consult your dealer for detailed information.

Optional accessories

1. Spare lamp kit

2. 3D glasses

Replacing the remote control batteries

1. Press and open the battery cover, as illustrated.
2. Remove the old batteries (if applicable) and install two AAA batteries. Make sure that the positive and negative ends are positioned correctly, as illustrated.
3. Replace the battery cover until it clicks into place.

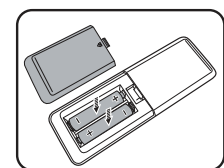
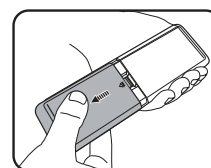

• Avoid leaving the remote control and batteries in an excessive heat or humid environment like the kitchen, bathroom, sauna, sunroom or in a closed car.

• Replace only with the same or equivalent type recommended by the battery manufacturer.

• Dispose of the used batteries according to the manufacturer's instructions and local environment regulations for your region.

• Never throw the batteries into a fire. There may be danger of an explosion.

• If the batteries are dead or if you will not be using the remote control for an extended period of time, remove the batteries to avoid damage to the remote control from possible battery leakage.

Projector exterior view

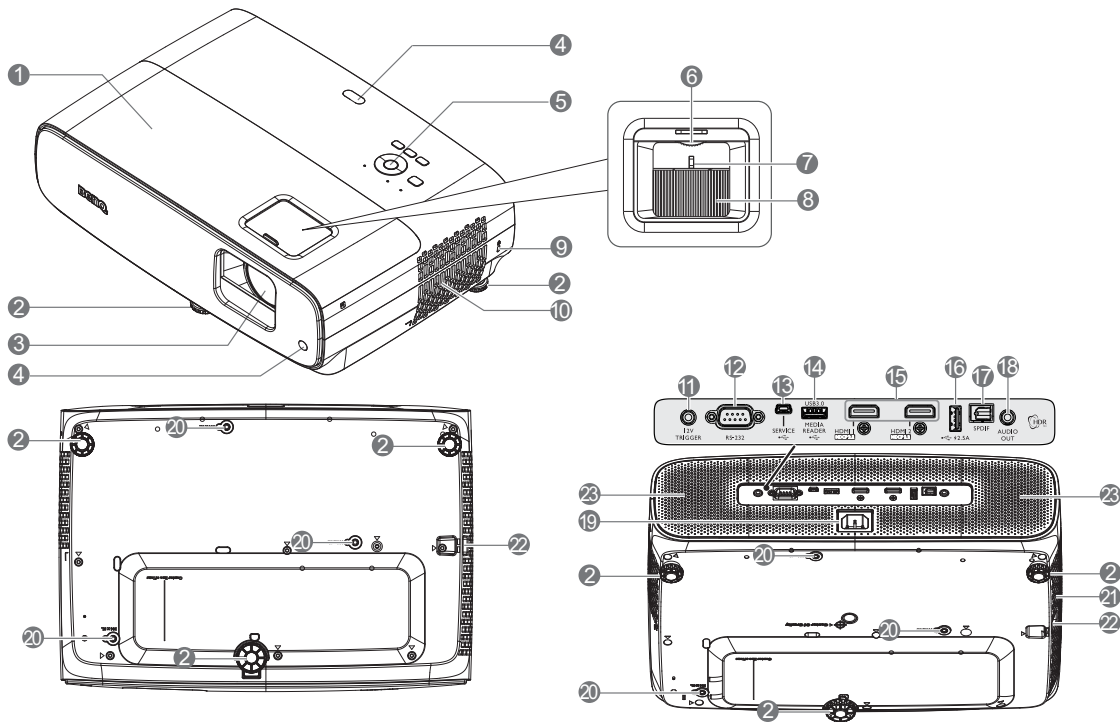

- 1. Lamp cover
- 2. Adjuster feet
- 3. Projection lens
- 4. IR remote sensor
- 5. External control panel
(See [Controls and functions](#) on page 9.)
- 6. Lens shift wheel
- 7. Zoom ring
- 8. Focus ring
- 9. Kensington anti-theft lock slot
- 10. Vent (air inlet)
- 11. 12V DC output terminal
Triggers external devices such as an electric screen or light control, etc.
- 12. RS-232 control port
- 13. USB Mini-B port (for firmware upgrades)
- 14. USB Type-A port (USB 3.0: 5V 1.5A media reader/drive, firmware download)
- 15. HDMI 1/ HDMI 2 input port (Version 2.0b)
- 16. USB Type-A port (USB 2.0: 2.5A power supply)
- 17. SPDIF output port
- 18. Audio output jack
- 19. AC power jack
- 20. Wall mount holes
- 21. Vent (air exhaust)
- 22. Security bar
- 23. Speaker

Controls and functions

Projector & Remote control



All the key presses described in this document are available on the remote control or projector.

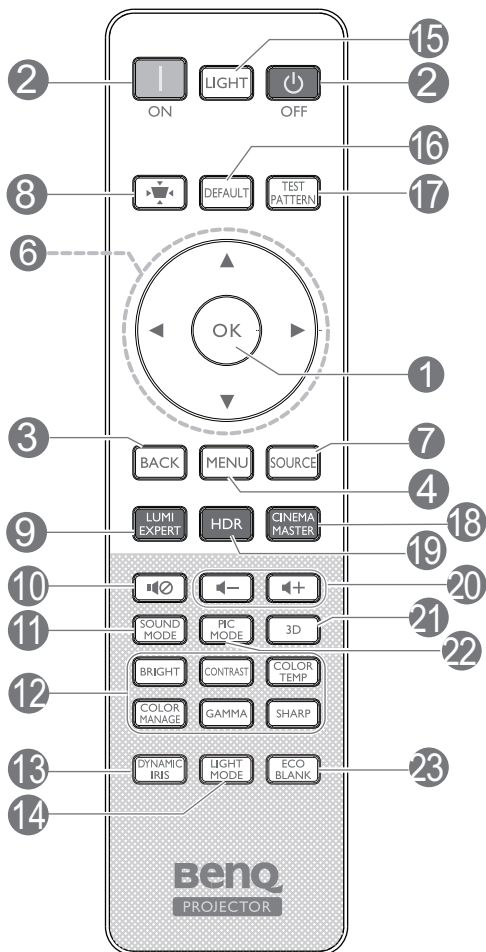
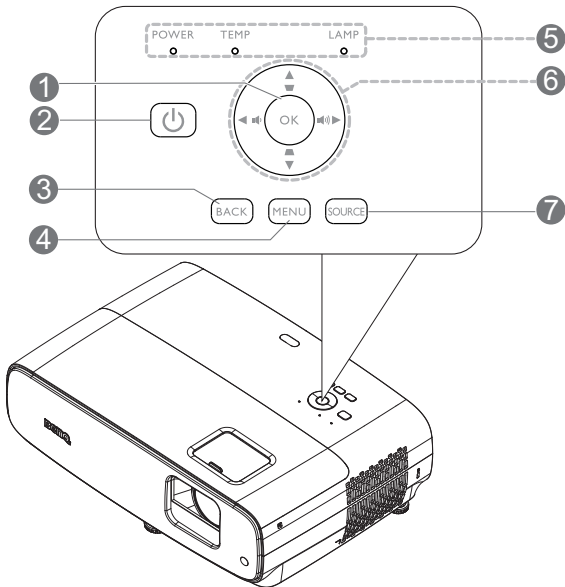

1. OK

Confirms the selected On-Screen Display (OSD) menu item.

When Keystone OSD pops up, long press for 2 seconds to reset Keystone.

2. POWER

Toggles the projector between standby mode and on.



Toggles the projector between standby mode and on.

3. BACK

Goes back to previous OSD menu, exits and saves menu settings.

4. MENU

Turns on the On-Screen Display (OSD) menu.

5. POWER indicator light/TEMPerature warning light/LAMP indicator light (See Indicators on page 37.)

6. Arrow keys (▲, ▼, ◀, ▶)

When the On-Screen Display (OSD) menu is activated, these keys are used as directional arrows to select the desired menu items and to make adjustments.

Keystone keys (▲, ▼)

Displays the keystone correction page.

Volume keys (🔊 / 🔊)

Decreases or increase the projector volume.

7. SOURCE

Displays the source selection bar.

8. Keystone correction key

Displays the Keystone correction menu.

9. LUMI EXPERT

Not operational on this projector.

10. 🔊

Toggles projector audio between on and off.

11. SOUND MODE

Displays the **SOUND MODE** menu.

12. Picture quality adjustment keys (**BRIGHT, CONTRAST, COLOR TEMP, COLOR MANAGE, GAMMA, SHARP**)

Displays the setting bars for adjustments of the appropriate picture quality values.

13. DYNAMIC IRIS

Selects a suitable **DYNAMIC IRIS** among the provided modes.

14. LIGHT MODE

Selects a suitable lamp power from among the provided modes.

15. LIGHT

Turns on the remote control backlight for a few seconds. To keep the backlight on, press any other key while the backlight is on. Press the key again to turn the backlight off.

16. DEFAULT

Resets to default value for all of adjustment bars menu when doing adjustment.

17. TEST PATTERN

Displays the **TEST PATTERN**.

18. CINEMA MASTER

Displays the CinemaMaster menu. See [CinemaMaster on page 26](#).

19. HDR

Displays the **HDR** menu.

20. Volume keys ◀-/▶+

Decreases or increases the projector volume.

21. 3D

Displays the **3D** menu.

22. PIC MODE

Displays the **Picture Mode** menu.

When Keystone OSD pops up, long press for 2 seconds to enable Auto Keystone.

23. ECO BLANK

Used to hide the screen picture.



Do not block the projection lens from projecting as this could cause the blocking object to become heated and deformed or even cause a fire.

Remote control effective range

The remote control must be held at an angle within 30 degrees perpendicular to the projector's IR remote control sensor(s) to function correctly. The distance between the remote control and the sensor(s) should not exceed 8 meters (~ 26 feet).

Make sure that there are no obstacles between the remote control and the IR sensor(s) on the projector that might obstruct the infra-red beam.

- Operating the projector from the front

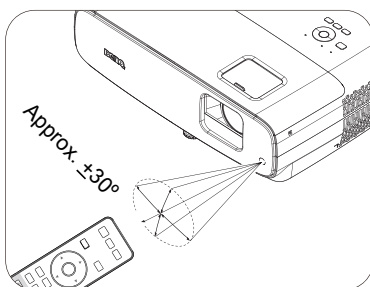

- Operating the projector from the top

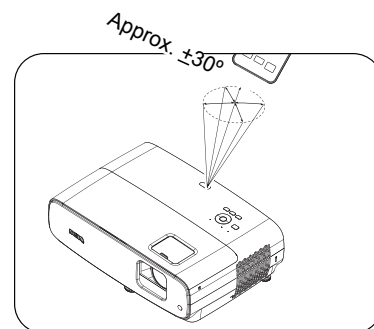

Positioning your projector

Choosing a location

Before choosing an installation location for your projector, take the following factors into consideration:

- Size and position of your screen
- Electrical outlet location
- Location and distance between the projector and the rest of your equipment

You can install your projector in the following ways.

1. Front Table

Select this location with the projector placed on the table in front of the screen. This is the most common way to position the projector for quick setup and portability.

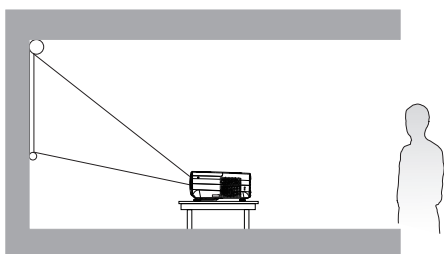

2. Rear Table

Select this location with the projector placed on the table behind the screen. Note that a special rear projection screen is required.

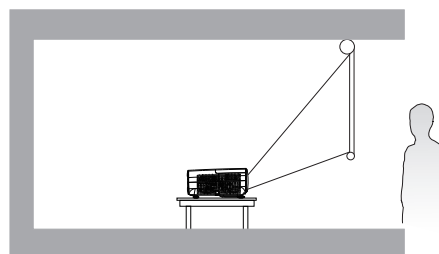

3. Front Ceiling

Select this location with the projector suspended upside-down in front of the screen. Purchase the BenQ Projector Ceiling/Wall Mount Kit from your dealer to mount your projector.

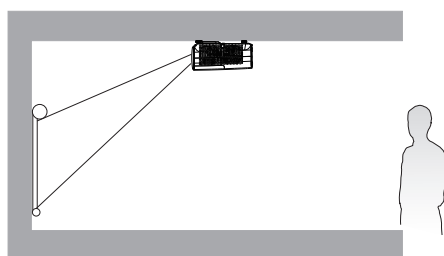

4. Rear Ceiling

Select this location with the projector suspended upside-down from behind the screen. Note that a special rear projection screen and the BenQ Projector Ceiling/Wall Mount Kit are required for this installation location.

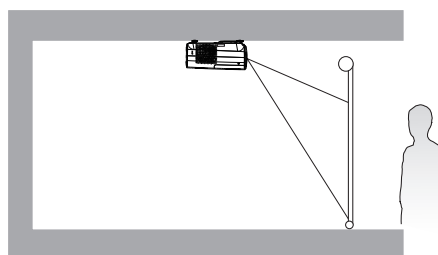

After turning on the projector, go to **INSTALLATION Menu > Projector Position** and press ◀/▶ to select a setting.

Obtaining a preferred projected image size

The distance from the projector lens to the screen, the zoom setting (if available), and the video format each factors in the projected image size.

Projection dimensions

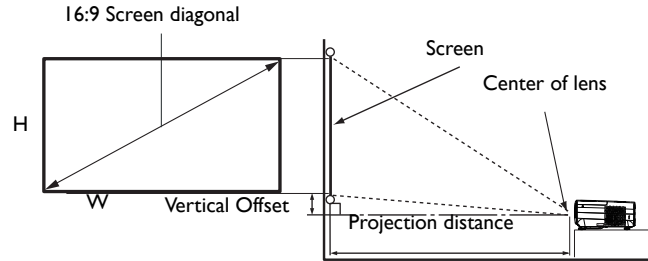

- The screen aspect ratio is 16:9 and the projected picture is in a 16:9 aspect ratio

Screen size				Distance from screen (mm)		
Diagonal		H (mm)	W (mm)	Min length	Average	Max length
Inch	mm			(max. zoom)		(min. zoom)
30	762	374	664	750	863	976
40	1016	498	886	1001	1151	1302
50	1270	623	1107	1251	1439	1627
60	1524	747	1328	1501	1727	1953
70	1778	872	1550	1751	2015	2278
80	2032	996	1771	2001	2302	2603
90	2286	1121	1992	2251	2590	2929
100	2540	1245	2214	2502	2878	3254
110	2794	1370	2435	2752	3166	3580
120	3048	1494	2657	3002	3454	3905
130	3302	1619	2878	3252	3741	4231
140	3556	1743	3099	3502	4029	4556
150	3810	1868	3321	3752	4317	4881
160	4064	1992	3542	4003	4605	5207
170	4318	2117	3763	4253	4893	5532
180	4572	2241	3985	4503	5180	5858
190	4826	2366	4206	4753	5468	6183
200	5080	2491	4428	5003	5756	6509
210	5334	2615	4649	5253	6044	6834
220	5588	2740	4870	5504	6331	7159
230	5842	2864	5092	5754	6619	7485
240	6096	2989	5313	6004	6907	7810
250	6350	3113	5535	6254	7195	8136
260	6604	3238	5756	6504	7483	8461
270	6858	3362	5977	6754	7770	8787
280	7112	3487	6199	7004	8058	9112
290	7366	3611	6420	7255	8346	9437
300	7620	3736	6641	7505	8634	9763

For example, if you are using a 120-inch screen, the recommended projection distance is 3454 mm.

If your measured projection distance is 5000 mm, the closest match in the "Distance from screen (mm)" column is 4893 mm. Looking across this row shows that a 170" (about 4.3 m) screen is required.



- All measurements are approximate and may vary from the actual sizes. BenQ recommends that if you intend to permanently install the projector, you should physically test the projection size and distance using the actual projector in situ before you permanently install it, so as to make allowance for this projector's optical characteristics. This will help you determine the exact mounting position so that it best suits your installation location.
- To optimize your projection quality, we suggest doing the projection by following the values in the non-gray cells.
- The values in the gray cells are for reference only.

Shifting the projection lens

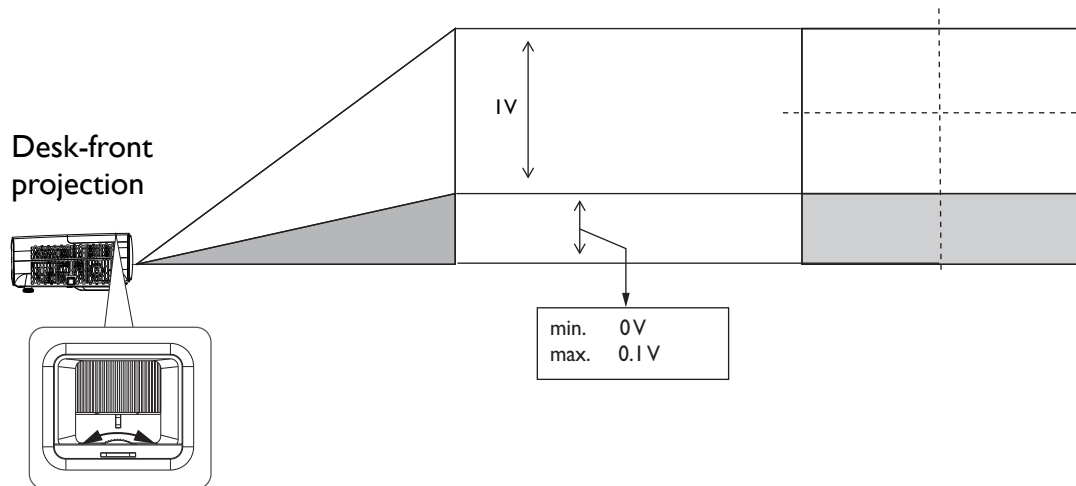

- Please stop turning the adjustment knob when you hear a clicking sound indicating the knob has reached its limit. Over-turning the knob may cause damage.

Mounting the projector

If you intend to mount your projector, we strongly recommend that you use a proper fitting BenQ projector mounting kit and that you ensure it is securely and safely installed.

If you use a non-BenQ brand projector mounting kit, there is a safety risk that the projector may fall down due to an improper attachment through the use of the wrong gauge or length screws.

Before mounting the projector

- Purchase a BenQ projector mounting kit from the place you purchased your BenQ projector.
- BenQ recommends that you also purchase a separate Kensington lock compatible security cable and attach it securely to both the Kensington lock slot on the projector and the base of the mounting bracket. This will perform the secondary role of restraining the projector should its attachment to the mounting bracket become loose.
- Ask your dealer to install the projector for you. Installing the projector on your own may cause it to fall and result in injury.
- Take necessary procedures to prevent the projector from falling off such as during an earthquake.
- The warranty doesn't cover any product damage caused by mounting the projector with a non-BenQ brand projector mounting kit.

- Consider the surrounding temperature where the projector is ceiling/wall mounted. If a heater is used, the temperature around the ceiling/wall may be higher than expected.
- Read the user manual for the mounting kit about the range of torque. Tightening with torque exceeding the recommended range may cause damage to the projector and subsequently falling off.
- Make sure the power outlet is at an accessible height so that you can easily shut down the projector.

Ceiling/Wall mount installation diagram

Ceiling/Wall mount screw: M4
(Max L = 25 mm; Min L = 20 mm)

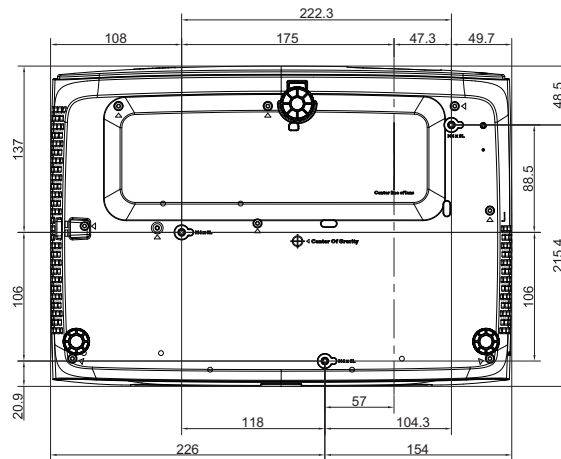

Unit: mm

Adjusting the projected image

Adjusting the projection angle

If the projector is not placed on a flat surface or the screen and the projector are not perpendicular to each other, the projected image becomes trapezoidal. You can screw the adjuster feet to fine-tune the horizontal angle.

To retract the feet, screw the adjuster feet in a reverse direction.

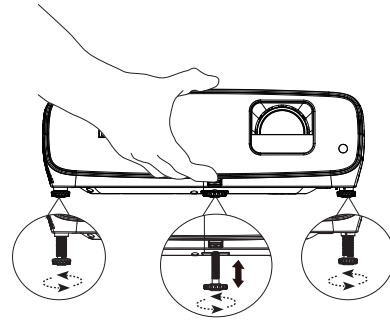

! Do not look into the lens while the lamp is on. The strong light from the lamp may cause damage to your eyes.

Fine-tuning the image size and clarity

Adjust the projected image to the size that you need using the zoom ring.

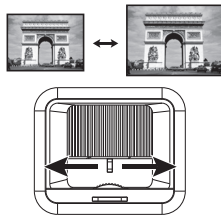

Sharpen the image by rotating the focus ring.

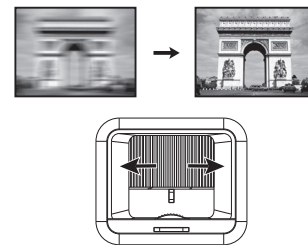





Correcting keystone

Keystoning refers to the situation where the projected image is noticeably wider at either the top or bottom. It occurs when the projector is not perpendicular to the screen.

To correct this, besides adjusting the height of the projector, you can use **Auto Keystone** or **Keystone** manually correct it following one of the these steps.

- Using the remote control or projector

Press  on the remote control or  /  on the projector to display the Keystone correction page. Press  to correct keystone at the top of the image. Press  to correct keystone at the bottom of the image. When Keystone OSD pops up, long press **OK** for 2 seconds to reset Keystone.

When Keystone OSD pops up, long press **PIC MODE** for 2 seconds to enable Auto Keystone.



Connection

When connecting a signal source to the projector, be sure to:

1. Turn all equipment off before making any connections.
2. Use the correct signal cables for each source.
3. Ensure the cables are firmly inserted.

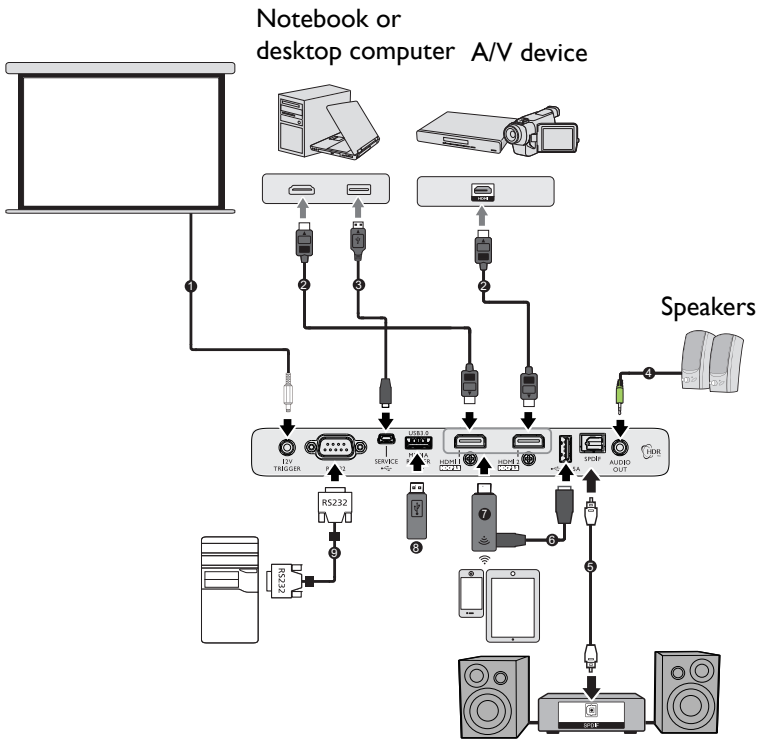



1	12V Trigger for screen control
2	HDMI cable
3	USB cable (Mini-B to A type)
4	Audio cable
5	SPDIF cable
6	USB cable (A to Micro B type) connect to the power port of HDMI wireless dongle
7	HDMI wireless dongle
8	USB Storage Device for Media Reader, Firmware Upgrade
9	RS232 cable



- In the connections above, some cables may not be included with the projector (see [Shipping contents on page 7](#)). They are commercially available from electronics stores.
- The connection illustrations are for reference only. The rear connecting jacks available on the projector vary with each projector model.
- Many notebooks do not turn on their external video ports when connected to a projector. Usually a key combo like FN + function key with a monitor symbol turns the external display on/off. Press FN and the labeled function key simultaneously. Refer to your notebook's documentation to find your notebook's key combination.
- If the selected video image is not displayed after the projector is turned on and the correct video source has been selected, check that the video source device is turned on and operating correctly. Also check that the signal cables have been connected correctly.
- The built-in speaker(s) will be muted when the AUDIO OUT jack is connected.
- Please check your computer's baud rate at 9600 so that you can connect the projector by using a suitable RS-232 cable.





Operation

Starting up the projector

1. Plug the power cord. Turn on the power outlet switch (where fitted). The power indicator on the projector lights orange after power has been applied.
2. Press  on the projector or  on the remote control to start the projector. The power indicator flashes green and stays green when the projector is on.

The start up procedure takes about 30 seconds. In the later stage of start up, a startup logo is projected.

(If necessary) Rotate the focus ring to adjust the image clearness.

3. If this is the first time you turn on the projector, the setup wizard appears to guide you through setting up the projector. If you have already done this, skip this step and move on to the next step.
 - Use the arrow keys (///) on the projector or remote control to move through the menu items.
 - Use **OK** to confirm the selected menu item.

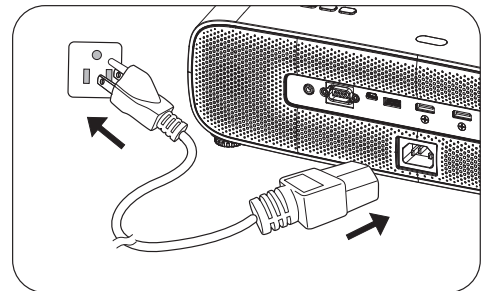

Step 1:

Specify **Projector Position**.

For more information about projector position, see [Choosing a location](#).

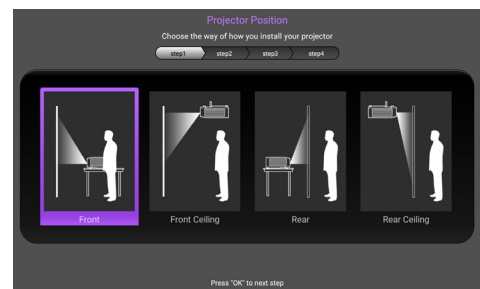

Step 2:

Specify OSD **Language**.

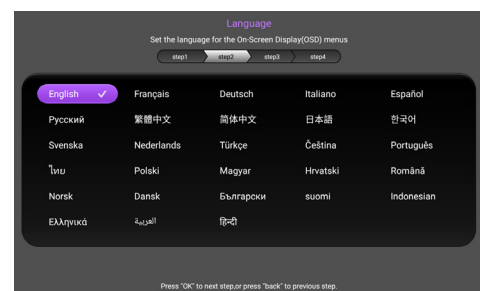

Step 3:

Specify **Vertical Keystone**.

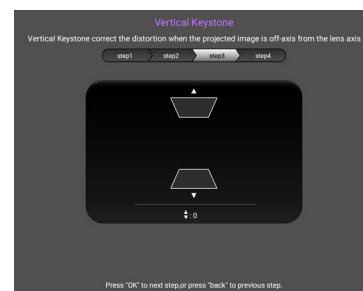

Step 4:

Specify **Auto Source**.

Select **On** if you want the projector to always search for available signals automatically when the projector is turned on.

Now you've completed the initial setup.

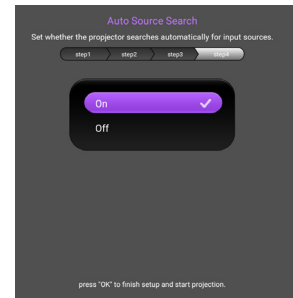

-
4. If you are prompted for a password, press the arrow keys to enter a 6-digit password. See [Utilizing the password function on page 20](#).
 5. Switch all of the connected equipment on.
 6. The projector will search for input signals. The current input signal being scanned appears. If the projector does not detect a valid signal, the message “No Signal” will continue displaying until an input signal is found.

You can also press **SOURCE** to select your desired input signal. See [Switching input signal on page 21](#).

- Please use the original accessories (e.g. power cord) to avoid possible dangers such as electric shock and fire.
 - If the projector is still hot from previous activity, it will run the cooling fan for approximately 90 seconds before energizing the lamp.
-
- The Setup Wizard screenshots are for reference only and may differ from the actual design.
 - If the frequency/resolution of the input signal exceeds the projector's operating range, you will see the message “Out of Range” displayed on the background screen. Please change to an input signal which is compatible with the projector's resolution or set the input signal to a lower setting. See [Timing chart on page 41](#).
 - If no signal is detected for 3 minutes, the projector automatically enters saving mode.

Using the menus

The projector is equipped with On-Screen Display (OSD) menus for making various adjustments and settings.



The OSD screenshots below are for reference only, and may differ from the actual design.

Below is the overview of the OSD menu.

	1	Main menu icon	4	Current input signal
	2	Main menu	5	Status
	3	Sub-menu	6	Press BACK to go to the previous page or to exit.

To access the OSD menu, press **MENU** on the projector or remote control.

- Use the arrow keys (◀/▶) on the projector or remote control to move through the main menu items.
- Use the arrow keys (▲/▼) on the projector or remote control to move through the sub-menu items.
- Use the arrow keys (◀/▶) on the projector or remote control to adjust the settings or press **OK** on the projector or remote control to enter the sub-menu.
- Press **MENU** twice* on the projector or remote control to leave and save the settings.

*The first press leads you back to the main menu and the second press closes the OSD menu.

Upgrading firmware

1. Go to BenQ Website and enter into **Product page > Support > Software** to download the latest firmware file.
2. Unzip the download file, find and save the file named "update_signed.zip" to the USB flash drive. (Suggest to use the USB flash drive with FAT32 format)
3. Insert USB flash drive into USB 3.0 port.
4. Go to **SYSTEM SETUP: ADVANCED > Firmware Upgrade** menu and press **OK**.
5. Select **Yes** to upgrade the firmware version. In the process of upgrading, please keep power on until updating finished.

6. When you see this message, firmware upgrade is done.

Securing the projector

Using a security cable lock

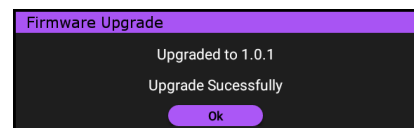
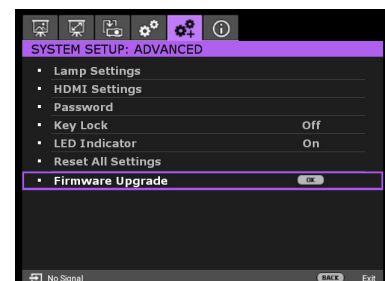
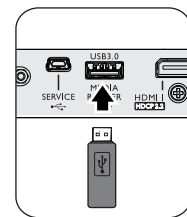

The projector has to be installed in a safe place to prevent theft. Otherwise, purchase a lock, such as the Kensington lock, to secure the projector. You can locate a Kensington lock slot on the rear side of the projector. See item 9 on [page 8](#).

A Kensington security cable lock is usually a combination of key(s) and the lock. Refer to the lock's documentation for finding out how to use it.

Utilizing the password function

Setting a password

1. Go to **SYSTEM SETUP: ADVANCED Menu > Password**. Press **OK**. The password setting page appears.
2. Highlight **Change Password** and press **OK**.
3. The four arrow keys (▲, ►, ▼, ◀) respectively represent 4 digits (1, 2, 3, 4). According to the password you desire to set, press the arrow keys to enter six digits for the password.
4. Confirm the new password by re-entering the new password.
Once the password is set, the OSD menu returns to the **Password** page.
5. To activate the **Power On Lock** function, press ▲/▼ to highlight **Power On Lock** and press ◀/▶ to select **On**. Input the password again.

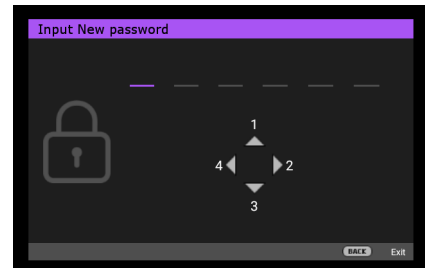

- The digits being input will display as asterisks on-screen. Make a note of your selected password and keep it in a safe place in advance or right after the password is entered so that it is available to you should you ever forget it.
- Once a password has been set and the power on lock is activated, the projector cannot be used unless the correct password is entered every time the projector is started.

If you forget the password

If you enter the wrong password, the password error message will appear, and the **Input Current Password** message follows. If you absolutely do not remember the password, you can use the password recall procedure. See [Entering the password recall procedure on page 20](#).

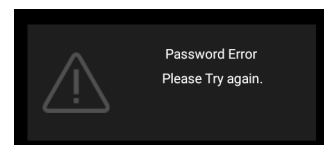

If you enter an incorrect password 5 times in succession, the projector will automatically shut down in a short time.

Entering the password recall procedure

1. Press and hold **OK** for 3 seconds. The projector will display a coded number on the screen.
2. Write down the number and turn off your projector.
3. Seek help from the local BenQ service center to decode the number. You may be required to provide proof of purchase documentation to verify that you are an authorized user of the projector.

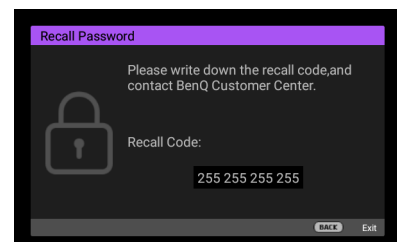

Changing the password

1. Go to **SYSTEM SETUP: ADVANCED Menu > Password > Change Password**.
2. Press **OK**. The message “**Input Current Password**” appears.

3. Enter the old password.
 - If the password is correct, another message **“Input New Password”** appears.
 - If the password is incorrect, the password error message will appear, and the message **“Input Current Password”** appears for your retry. You can press **BACK** to cancel the change or try another password.
4. Enter a new password.
5. Confirm the new password by re-entering the new password.

Disabling the password function

To disable password protection, go to **SYSTEM SETUP: ADVANCED Menu > Password > Power On Lock** and press **◀/▶** to select **Off**. The message **“Input Current Password”** appears. Enter the current password.

- If the password is correct, the OSD menu returns to the password setting page. You will not have to enter the password next time turning on the projector.
- If the password is incorrect, the password error message will appear, and the message **“Input Current Password”** appears for your retry. You can press **BACK** to cancel the change or try another password.



Though the password function is disabled, you need to keep the old password in hand should you ever need to re-activate the password function by entering the old password.

Switching input signal

The projector can be connected to multiple devices at the same time. However, it can only display one full screen at a time. When starting up, the projector automatically searches for the available signals.

Be sure the **SYSTEM SETUP: BASIC Menu > Auto Source** menu is **On** if you want the projector to automatically search for the signals.

To select the source:

1. Press **SOURCE**. A source selection bar appears.
2. Press **▲/▼** until your desired signal is selected and press **OK**.

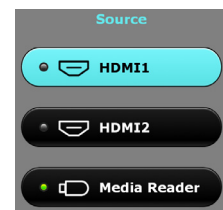

Once detected, the selected source information will appear at the corner of the screen for seconds. If there is multiple equipment connected to the projector, repeat steps 1-2 to search for another signal.



- The brightness level of the projected image will change accordingly when you switch between different input signals.
- For best display picture results, you should select and use an input signal which outputs at the projector’s native resolution. Any other resolutions will be scaled by the projector depending upon the "aspect ratio" setting, which may cause some image distortion or loss of picture clarity. See [Aspect Ratio on page 28](#).

Presenting from a Media Reader

The USB port on the projector allows you to browse the image and document files stored on a USB flash drive connected to the projector. It can eliminate the need for a computer source.





Supported files formats

Video format	Audio format	Photo format
<ul style="list-style-type: none">• MPEG I• MPEG4• H.263• Motion JPEG	<ul style="list-style-type: none">• MPEG I/2 Layer I• MPEG I/2 Layer2• FLAC	<ul style="list-style-type: none">• JPEG Base-line• JPEG Progressive• PNG non-interlace• PNG interlace• BMP

Viewing files

1. Plug a USB flash drive into the **MEDIA READER** port of the projector.
2. Press **SOURCE** and select **Media Reader**. The projector displays the built in media reader main page.
3. Press ▲/▶/▼/◀ to select and press **OK** to enter the sub-folder or display a file.
4. After a file is displayed, press **OK** to call out the function bar. You can press ▲/▼ to select the function and press **OK** to enact the selected item.

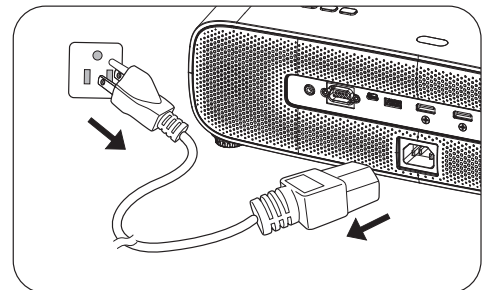

Shutting down the projector

1. Press  on the projector or  on the remote control and a confirmation message will appear prompting you. If you don't respond in a few seconds, the message will disappear.
2. Press  or  a second time. The power indicator flashes orange, the projection lamp shuts down, and the fans will continue to run for approximately 90 seconds to cool down the projector.
3. Once the cooling process finishes, the power indicator becomes a steady orange and fans stop. Disconnect the power cord from the power outlet.



- To protect the lamp, the projector will not respond to any commands during the cooling process.
- Avoid turning on the projector immediately after turning it off as excessive heat may shorten lamp life.
- Lamp life results will vary depending on environmental conditions and usage.

Direct power off

The AC power cord can be pulled out right after the projector is turned off. To protect the lamp, wait about 10 minutes before re-starting the projector. If you attempt to re-start the projector, the fans may run for a few minutes to cool down. In such cases, press  or  again to start the projector after the fans stop and the power indicator turns orange.

Menu operation

Please note that the on-screen display (OSD) menus vary according to the signal type selected and the projector model you are using.

The menu items are available when the projector detects at least one valid signal. If there is no equipment connected to the projector or no signal detected, limited menu items are accessible.

PICTURE menu

<p>Picture Mode</p>	<p>The projector is preset with several predefined picture modes so that you can choose one to suit your operating environment and input signal picture type.</p> <ul style="list-style-type: none">• Bright: Maximizes the brightness of the projected image. This mode is suitable for environments where extra-high brightness is required, such as using the projector in well lit rooms.• Living Room: With well-saturated color, fine-tuned sharpness and a higher brightness level, Living Room mode is perfect for watching movies in a living room where there is a small amount of ambient light.• Sports: Complement with Sport Mode settings which is suitable for watching sport events in a bright room with ambient light.• Cinema: Complement with accurate color and deepest contrast at lower brightness level, Cinema mode is suitable for playing movies in an environment with a bit of ambient light, like in living room.• User: Recalls the settings customized based on the current available picture modes. See User Mode Management on page 24.• Silence: Hidden as default. Shows only when Silence is switched on in the DISPLAY menu.• 3D: Is appropriate for playing 3D images and 3D video clips. <p> This mode is only available when 3D function is enabled.</p> <ul style="list-style-type: none">• HLG: Delivers Hybrid Long Gamma effects by adding a logarithmic curve with extra brightness over the top of the signal. This mode is only available when: DISPLAY > HDR is set at Auto, and HLG content is detected.
----------------------------	--

<p>User Mode Management</p>	<p>• Load Settings From</p> <p>There is one user-definable mode if the current available picture modes are not suitable for your need. You can use one of the picture modes (except the User) as a starting point and customize the settings.</p> <ol style="list-style-type: none"> 1. Go to PICTURE > Picture Mode. 2. Press ◀/▶ to select User. 3. Press ▼ to highlight User Mode Management and press OK. 4. Press ▼ to select Load Settings From and press OK. 5. Press ▼ to select a picture mode that is closest to your need. 6. Press ▼ to select the sub-menu items you want to change and adjust the values with ◀/▶. The adjustments define the selected user mode. <p>• Rename User Mode</p> <p>You can change User to the names easy to be identified or understood by the users of this projector. The new name can be up to 9 characters including English letters (A-Z, a-z), digits (0-9), and space (_).</p> <ol style="list-style-type: none"> 1. Go to PICTURE > Picture Mode > User. 2. Press ▼ to highlight User Mode Management and press OK. 3. Press ▼ to select Rename User Mode and press OK. 4. Use ▲/▼/◀/▶, and OK to set desired characters. 5. When done, press BACK to save the changes and exit.
<p>Brightness</p>	<p>The higher the value, the brighter the image. Adjust this control so the black areas of the image appear just as black and that detail in the dark areas is visible.</p>
<p>Contrast</p>	<p>The higher the value, the greater the contrast. Use this to set the peak white level after you have previously adjusted the Brightness setting to suit your selected input and viewing environment.</p>
<p>Color</p>	<p>Lower setting produces less saturated colors. If the setting is too high, colors on the image will be overpowering, which makes the image unrealistic.</p>
<p>Tint</p>	<p>The higher the value, the more greenish the picture becomes. The lower the value, the more reddish the picture becomes.</p>
<p>Sharpness</p>	<p>The higher the value, the sharper the picture becomes.</p>
<p>Advanced</p>	<p>Gamma Selection</p> <p>Gamma refers to the relationship between input source and picture brightness. Choose a preferred gamma mode from among 1.8/2.0/2.1/2.2/2.3/2.4/2.5/2.6/BenQ.</p> <p>HDR Brightness</p> <p>The projector can automatically adjust the brightness levels of your image according to the input source. You can also manually select a brightness level to display better picture quality. When the value is higher, the image becomes brighter; when the value is lower, the image becomes darker.</p>

Color Temperature

There are several preset color temperature settings available. The available settings may vary according to the signal type selected.

- **Preset:** Selects a color temperature from among **Normal**, **Cool**, **Lamp Native**, or **Warm**.

You can also set a preferred color temperature by adjusting the following options.

- **Red Gain/Green Gain/Blue Gain:** Adjusts the contrast levels of Red, Green, and Blue.
- **Red Offset/Green Offset/Blue Offset:** Adjusts the brightness levels of Red, Green, and Blue.

Color Management

This function provides six sets (RGBCMYW) of colors to be adjusted. When you select each color, you can independently adjust its range and saturation according to your preference.

- **Primary Color:** Selects a color from among **R** (Red), **G** (Green), **B** (Blue), **C** (Cyan), **M** (Magenta), **Y** (Yellow), or **W** (White).
- **Hue:** Increase in the range will include colors consisted of more proportions of its two adjacent colors. Please refer to the illustration for how the colors relate to each other. For example, if you select Red and set its range at 0, only pure red in the projected picture will be selected. Increasing its range will include red close to yellow and red close to magenta.
- **Saturation:** Adjusts the values to your preference. Every adjustment made will reflect to the image immediately. For example, if you select Red and set its value at 0, only the saturation of pure red will be affected.

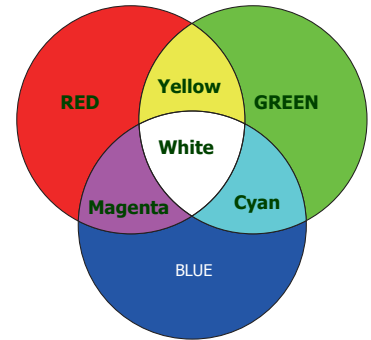

Saturation is the amount of that color in a video picture. Lower settings produce less saturated colors; a setting of "0" removes that color from the image entirely. If the saturation is too high, that color will be overpowering and unrealistic.

- **Gain:** Adjusts the values to your preference. The contrast level of the primary color you select will be affected. Every adjustment made will reflect to the image immediately.







When "White" is selected, "Hue/Saturation/Gain" is changed into "Red Gain/Green Gain/Blue Gain."

Advanced (Continued)	<p>CinemaMaster</p> <ul style="list-style-type: none"> • Color Enhancer: Allows you to fine-tune the saturation of colors with larger flexibility. It modulates complex color algorithms to flawlessly render saturated colors, fine gradients, intermediate hues and subtle pigments. • Flesh Tone: Provides a smart adjustment of hue only for calibrating people's skin color, not other colors in the image. It prevents discoloration of skin tones from the light of the projection beam, portraying every skin tone in its most beautiful shade. • Pixel Enhancer 4K: It is a super-resolution technology which radically enhances Full HD content in terms of colors, contrast, and textures. It's also a Detail Enhancement Technology refines surface details for true-to-life images that pop off the screen. Users can adjust levels of sharpness and detail enhancement for optimal viewing. • Motion Enhancer 4K: You can use this feature to smooth fast-moving videos by comparing consecutive image frames and inserting an intermediate image frame between them.
	<p>Noise Reduction</p> <p>Reduces electrical image noise caused by different media players.</p>
	<p>Dynamic Iris</p> <p>Changes the black level of the projected pictures to enhance the effect of contrast ratio.</p>
	<p>Brilliant Color</p> <p>This feature utilizes a new color-processing algorithm and system level enhancements to enable higher brightness while providing truer, more vibrant colors in picture. It enables a greater than 50% brightness increase in mid-tone images, which are common in video and natural scenes, so the projector reproduces images in realistic and true colors.</p>
	<p>Light Mode</p> <p>Selects a suitable lamp power from among the provided modes. See Extending lamp life on page 33.</p>
Reset Current Picture Mode	Returns all of the adjustments you've made for the selected Picture Mode to the factory preset values.

DISPLAY menu

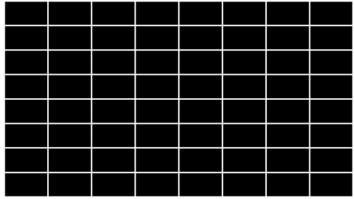
<p>Overscan Adjustment</p>	<p>Conceals the poor picture quality in the four edges.</p> <p>The greater the value, the more portion of the picture is concealed while the screen remains filled and geometrically accurate. Setting 0 means the picture is 100% displayed.</p>
<p>3D</p>	<p>This projector features a 3D function which enables you to enjoy the 3D movies, videos, and sporting events in a more realistic way by presenting the depth of the images. You need to wear a pair of 3D glasses to view the 3D images.</p> <ul style="list-style-type: none"> • 3D Mode: The default setting is Auto and the projector automatically chooses an appropriate 3D format when detecting 3D contents. If the projector cannot recognize the 3D format, manually choose a 3D mode according to your preference. • 3D Sync Invert: When your 3D image is distorted, enable this function to switch between the image for the left eye and the right eye for more comfortable 3D viewing experience.
<p>HDR</p>	<p>The projector supports HDR imaging sources. It can automatically detect the dynamic range of the source for SDR or HDR10 or HLG, and optimize settings to reproduce contents under wider dynamic range. Meanwhile, the Picture Mode cannot be adjusted after switching to HDR.</p>
<p>Silence</p>	<p>Minimizes the acoustic noise. It is suitable for the need of watching movies that requires an ultra-quiet environment so that you won't be disturbed by the noise of the projector. When this mode is used, the following menu functions will be automatically changed to the designated settings and grayed out.</p> <ul style="list-style-type: none"> • Off: To turn on XPR (The display resolution will be 3840 x 2160.) • On: To turn off XPR (The display resolution will be 1920 x 1080.)

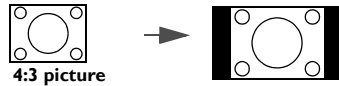

INSTALLATION menu

<p>Projector Position</p>	<p>The projector can be installed on a ceiling or behind a screen, or with one or more mirrors. See Choosing a location on page 11.</p>
<p>Auto Keystone</p>	<p>Corrects any keystone of the image automatically.</p>
<p>Test Pattern</p>	<p>Adjusts the image size and focus and check that the projected image is free from distortion.</p> 
<p>Aspect Ratio</p>	<p>There are several options to set the image's aspect ratio depending on your input signal source.</p> <ul style="list-style-type: none"> • Auto: Scales an image proportionally to fit the projector's native resolution in its horizontal or vertical width. • 4:3: Scales an image so that it is displayed in the center of the screen with a 4:3 aspect ratio. • 16:9: Scales an image so that it is displayed in the center of the screen with a 16:9 aspect ratio.   
<p>12V Trigger</p>	<p>There are two 12V triggers that work independently according to your needs for installation scenarios.</p> <ul style="list-style-type: none"> • On: If this is selected, the projector will send electronic signal out when it is turned on. • Off: If this is selected, the projector will not send electronic signal out when it is turned on.
<p>High Altitude Mode</p>	<p>We recommend you use the High Altitude Mode when your environment is between 1500 m –3000 m above sea level, and ambient temperature is between 0°C–30°C.</p> <p>Operation under "High Altitude Mode" may cause a higher decibel operating noise level because of increased fan speed necessary to improve overall system cooling and performance.</p> <p>If you use this projector under other extreme conditions excluding the above, it may display auto shut-down symptoms, which is designed to protect your projector from over-heating. In cases like this, you should switch to High Altitude mode to solve these symptoms. However, this is not to state that this projector can operate under any and all harsh or extreme conditions.</p>  <ul style="list-style-type: none"> • Do not use the High Altitude Mode if your altitude is between 0 m and 1500 m and ambient temperature is between 0°C and 35°C. The projector will be over cooled, if you turn the mode on under such a condition.

SYSTEM SETUP: BASIC menu

Language	Sets the language for the On-Screen Display (OSD) menus.
Splash Screen	Allows you to select which logo screen will be displayed during projector start-up.
Auto Off	Allows the projector to turn off automatically if no input signal is detected after a set period of time to prevent unnecessary waste of lamp life.
Direct Power On	Allows the projector to turn on automatically once the power is fed through the power cord.
Menu Settings	<ul style="list-style-type: none"> • Menu Position: Sets the On-Screen Display (OSD) menu position. • Menu Display Time: Sets the length of time the OSD will remain active after your last key press. • Reminder Message: Sets the reminder messages on or off.
Source Rename	<p>Renames the current input source to your desired name.</p> <p>On the Source Rename page, use ▲/▼/◀/▶, and OK to set the desired characters for the connected source item.</p> <p>When done, press BACK to save the changes and exit.</p>
Auto Source	Allows the projector to automatically search for a signal.
Sound	<ul style="list-style-type: none"> • Sound Mode: <ul style="list-style-type: none"> • Effect Mode: This function utilizes MaxxAudio sound enhancement technology, which incorporates Waves's algorithms to deliver great effects of the bass and treble, and provide you with immersive cinematic audio experience. The following preset sound modes are provided: Standard, Cinema, Music, Game, Sports and User. The User mode allows you to personalize the sound settings. When selecting the User mode, you may make manual adjustments with the User EQ function. If the Mute function is activated, adjusting Sound Mode will turn off the Mute function. • User EQ: Select desired frequency bands (100 Hz, 300 Hz, 1k Hz, 3k Hz, and 10k Hz) to adjust the levels according to your preference. The settings made here define the User mode. • Mute: Temporarily turns off the sound. • Volume: Adjusts the sound level. • S/PDIF: Enable or disable S/PDIF. • L/R Switch: Switch the left/right audio channels. • Power On/Off Ring Tone: Turns on or off the ring tone when the projector is in startup and shutdown process. <p> The only way to change Power On/Off Ring Tone is setting On or Off here. Setting the sound mute or changing the sound level will not affect the Power On/Off Ring Tone.</p> <ul style="list-style-type: none"> • Reset Audio Settings: All of the adjustments you've done for the Sound menu return to the factory preset values.

SYSTEM SETUP: ADVANCED menu

<p>Lamp Settings</p>	<ul style="list-style-type: none"> • Reset Lamp Timer: See Resetting the lamp timer on page 36. • Lamp Timer: See Getting to know the lamp hour on page 32.
<p>HDMI Settings</p>	<ul style="list-style-type: none"> • HDMI Format Selects a suitable color format to optimize display quality. <ul style="list-style-type: none"> • Auto: Automatically selects a suitable color space and gray level for the incoming HDMI signal. • RGB Limited: Utilizes the Limited range RGB 16-235. • RGB Full: Utilizes the Full range RGB 0-255. • YUV Limited: Utilizes the Limited range YUV 16-235. • YUV Full: Utilizes the Full range YUV 0-255. • HDMI Equalizer Adjusts the equalizer gain settings for an HDMI signal. The higher the setting, the stronger the gain value. If there are more than one HDMI port on the projector, select the HDMI port first before adjusting the value. • HDMI EDID Switch HDMI EDID between HDMI 1.4 or HDMI 2.0 in order to solve compatibility issue with uncertain old players. <ul style="list-style-type: none"> • Enhanced: Enhanced mode can switch to HDMI 2.0 EDID • Standard: Standard mode can switch to HDMI 1.4 EDID. • Audio Return (HDMI-I) Enable or disable the Audio Return function which is only support on HDMI-I. <ul style="list-style-type: none"> • On: Enable Audio Return to return audio to speaker. When connecting to ARC (Audio Return Channel) compatible speaker to the projector with HDMI cables, the audio can be returned to these speaker from the projector. • Off: Disable Audio Return function.
<p>Password</p>	<p>See Utilizing the password function on page 20.</p>
<p>Key Lock</p>	<p>With the control keys on the projector and remote control locked, you can prevent your projector settings from being changed accidentally (by children, for example). When the Key Lock is on, no control keys on the projector will operate except  POWER.</p> <p>To release panel key lock, press and hold ► (the right key) on the projector or remote control for 3 seconds.</p>  <p>If you turn off the projector without disabling panel key lock, the projector will still be in locked status the next time it is turned on.</p>
<p>LED Indicator</p>	<p>You can turn off the LED warning lights. This is to avoid any light disturbance when viewing images in a dark room.</p>

Reset All Settings	<p>Returns all settings to the factory preset values.</p>  <p>The following settings will still remain: Picture Mode, User Mode Management, Brightness, Contrast, Color, Tint, Sharpness, Advanced, Projector Position, Sound, Source Rename and Password.</p>
Firmware Upgrade	<p>Updates firmware version.</p>

INFORMATION menu

INFORMATION	<ul style="list-style-type: none"> • Source: Shows the current signal source. • Picture Mode: Shows the selected mode in the Picture menu. • Resolution: Shows the native resolution of the input signal. • Color System: Shows input system format. • Color Gamut: When HDR10 is enabled, shows enabled Color Gamut. When HLG is enabled, shows BT. 2020. • Light Usage Time: Shows the number of hours the lamp has been used. • 3D Format: Shows the current 3D mode. • Firmware Version: Shows the firmware version of your projector. • Service Code: Shows the serial number of your projector.
--------------------	---

Maintenance

Care of the projector

Cleaning the lens

Clean the lens whenever you notice dirt or dust on the surface. Please be sure to turn off the projector and let it cool down completely before cleaning the lens.

- Use a canister of compressed air to remove dust.
- If there is dirt or smears, use lens-cleaning paper or moisten a soft cloth with lens cleaner and gently wipe the lens surface.
- Never use any type of abrasive pad, alkaline/acid cleaner, scouring powder, or volatile solvent, such as alcohol, benzene, thinner or insecticide. Using such materials or maintaining prolonged contact with rubber or vinyl materials may result in damage to the projector surface and cabinet material.

Cleaning the projector case

Before you clean the case, turn the projector off using the proper shutdown procedure as described in [Shutting down the projector on page 22](#) and unplug the power cord.

- To remove dirt or dust, wipe the case with a soft, lint-free cloth.
- To remove stubborn dirt or stains, moisten a soft cloth with water and a neutral pH detergent. Then wipe the case.



Never use wax, alcohol, benzene, thinner or other chemical detergents. These can damage the case.

Storing the projector

If you need to store the projector for an extended time, please follow the instructions below:

- Make sure the temperature and humidity of the storage area are within the recommended range for the projector. Please refer to [Specifications on page 39](#) or consult your dealer about the range.
- Retract the adjuster feet.
- Remove the battery from the remote control.
- Pack the projector in its original packing or equivalent.

Transporting the projector

It is recommended that you ship the projector with its original packing or equivalent.

Lamp information

Getting to know the lamp hour

When the projector is in operation, the duration (in hours) of lamp usage is automatically calculated by the built-in timer. The method of calculating the equivalent lamp hour is as follows:

1. Lamp Usage Time = (x+y+z) hours, if
 - Time used in Normal mode = x hours
 - Time used in Eco mode = y hours
 - Time used in SmartEco mode = z hours

2. Equivalent Lamp Hour = α hours

$$\alpha = \frac{A'}{X} \times X + \frac{A'}{Y} \times Y + \frac{A'}{Z} \times Z, \text{ if}$$

X = lamp life spec of Normal mode

Y = lamp life spec of Eco mode

Z = lamp life spec of SmartEco mode

A' is the longest lamp life spec among X, Y, Z



For Time used in each lamp mode shown in OSD menu:

- Time used is accumulated and rounded down to an integer in Hours.
- When time used is less than 1 hour, it shows 0 hours.

When you calculate Equivalent Lamp hour manually, it will probably have deviation from the value shown in OSD menu since projector system calculates Time used for each lamp mode in "Minutes" then rounds down to an integer in hours shown in OSD.

To obtain the lamp hour information:

1. Go to **SYSTEM SETUP: ADVANCED Menu > Lamp Settings** and press **OK**. The **Lamp Settings** page appears.
2. Press **▼** to select **Lamp Timer** and press **OK**. The **Lamp Timer** information is displayed.

You can also get the lamp hour information on the **INFORMATION** menu.

Extending lamp life

• Setting the **Light Mode**

Go to **PICTURE Menu > Advanced > Light Mode** and select a suitable lamp power from among the provided modes.

Setting the projector in **Economic** or **SmartEco** mode extends lamp life.

Lamp mode	Description
Normal	Provides full lamp brightness
Economic	Lowers brightness to extend the lamp life and decreases the fan noise
SmartEco	Adjusts the lamp power automatically depending on the content brightness level while optimizing display quality

• Setting **Auto Off**

This function allows the projector to turn off automatically if no input signal is detected after a set period of time to prevent unnecessary waste of lamp life.

To set **Auto Off**, go to **SYSTEM SETUP: BASIC Menu > Auto Off** and press **◀/▶**.

Timing of replacing the lamp

When the **Lamp indicator** lights up or a message appears suggesting it is time to replace the lamp, please consult your dealer or go to <http://www.BenQ.com> before installing a new lamp. An old lamp may cause a malfunction in the projector and in some instances the lamp may explode.



- The apparent brightness of the projected image will vary depending on the ambient lighting conditions, selected input signal contrast/brightness settings, and is directly proportional to projection distance.
- The lamp brightness will decline over time and may vary within the lamp manufacturers specifications. This is normal and expected behavior.
- The **LAMP indicator light** and **TEMPERature warning light** will light up if the lamp becomes too hot. Turn the power off and let the projector cool for 45 minutes. If the Lamp or Temp indicator still lights up after turning the power back on, please contact your dealer. See [Indicators on page 37](#).

The following Lamp warning displays will remind you to change the lamp.

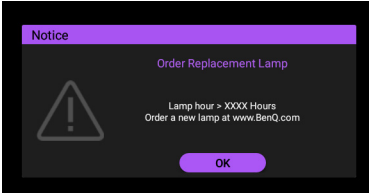
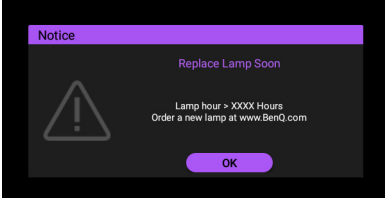
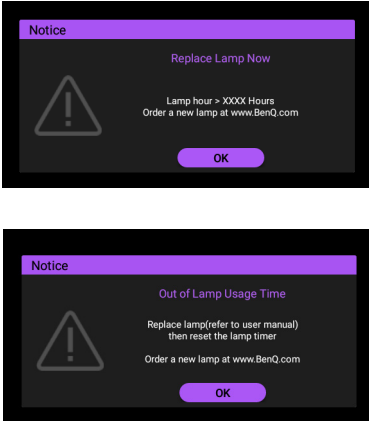
	<p>Install a new lamp for optimal performance. Press OK to dismiss the message.</p>
	<p>It is strongly recommended that you replace the lamp at this age. The lamp is a consumable item. The lamp brightness diminishes with use. This is normal lamp behavior. You can replace the lamp whenever you notice that the brightness level has significantly diminished. Press OK to dismiss the message.</p>
	<p>The lamp MUST be replaced before the projector will operate normally. Press OK to dismiss the message.</p>



"XXXX" shown in the above messages are numbers that vary depending on different models.

Replacing the lamp



- To reduce the risk of electrical shock, always turn the projector off and disconnect the power cord before changing the lamp.
- To reduce the risk of severe burns, allow the projector to cool for at least 45 minutes before replacing the lamp.
- To reduce the risk of injuries to fingers and damage to internal components, use caution when removing lamp glass that has shattered into sharp pieces.
- To reduce the risk of injuries to fingers and/or compromising image quality by touching the lens, do not touch the empty lamp compartment when the lamp is removed.
- This lamp contains mercury. Consult your local hazardous waste regulations to dispose of this lamp in a proper manner.
- To assure optimal performance from the projector, it is recommended that you purchase a qualified projector lamp for lamp replacement.
- If lamp replacement is performed while the projector is suspended upside-down, make sure that no one is underneath the lamp socket to avoid any possible injury or damage to the human eyes caused by fractured lamp.
- Ensure good ventilation when handling broken lamps. We recommend that you use respirators, safety glasses, goggles or face shield and wear protective clothing such as gloves.

- I. Turn the power off and disconnect the projector from the power outlet. If the lamp is hot, avoid burns by waiting for approximately 45 minutes until the lamp has cooled.

2. Loosen the screw(s) that secure the lamp cover on the side of the projector until the lamp cover loosens.

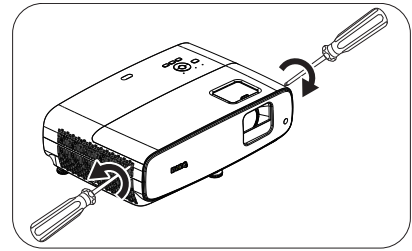

3. Remove the lamp cover from the projector.



- Do not turn the power on with the lamp cover open.
- Do not insert your fingers between the lamp and the projector. The sharp edges inside the projector may cause injuries

4. Remove the safety mylar.

5. Disconnect the lamp connector.

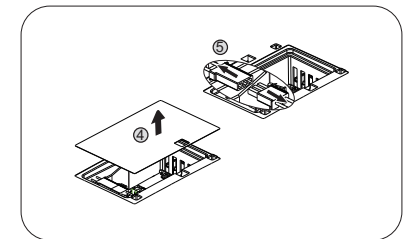
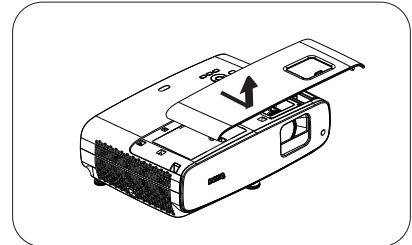

6. Loosen the screw(s) that secure the inner lamp.

7. Lift the handle so that it stands up.

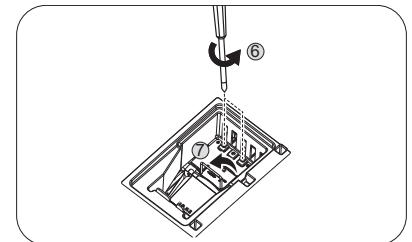

8. Use the handle to slowly pull the lamp out of the projector.



- Pulling it too quickly may cause the lamp to break and scatter broken glass in the projector.
- Do not place the lamp in locations where water might splash on it, children can reach it, or near flammable materials.
- Do not insert your hands into the projector after the lamp is removed. The sharp edges inside the projector may cause injuries. If you touch the optical components inside, it could cause color unevenness and distortion of the projected images.

9. Insert the lamp connector.

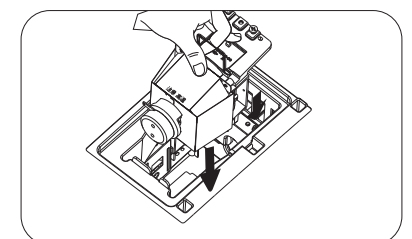
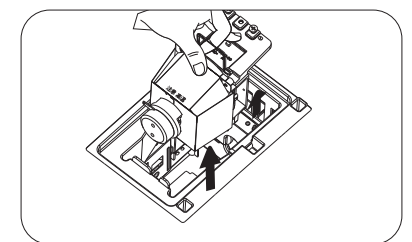

10. Tighten the screw(s) that secures the lamp.

11. Ensure the handle is fully laid flat and locked in place.



- Loose screw may cause a bad connection, which could result in malfunction.
- Do not over tighten the screw.

12. Connect the lamp connector.

13. Put the safety mylar back to the top.

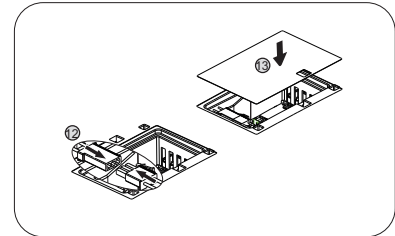
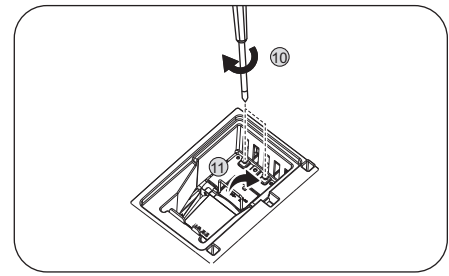

14. Replace the lamp cover on the projector.

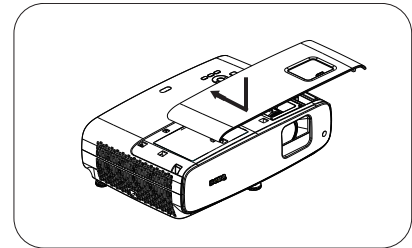

15. Tighten the screw that secures the lamp cover.



- Loose screw may cause a bad connection, which could result in malfunction.
- Do not over tighten the screw.

16. .Connect the power and restart the projector.

Resetting the lamp timer







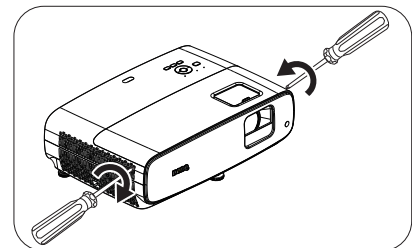





















17. After the startup logo, open the On-Screen Display (OSD) menu. Go to **SYSTEM SETUP: ADVANCED Menu > Lamp Settings** and press **OK**. The **Lamp Settings** page appears. Highlight **Reset Lamp Timer** and press **OK**. A warning message is displayed asking if you want to reset the lamp timer. Highlight **Reset** and press **OK**. The lamp time will be reset to "0".











- Do not reset if the lamp is not new or replaced as this could cause damage.



Indicators

Light			Status & Description
POWER ○	TEMP ○	LAMP ○	
System events			
			System is in stand-by mode
			System is powering up
			System is under normal operation
			System is cooling down
			Downloading
			Colorwheel start fail
			Scaler reset fail
			Lamp life exhausted
			Lamp door is not closed
Burn-In events			
			Burn-in on
			Burn-in off
Lamp events			
			Lamp error in normal operation
			Lamp is not lit up
Thermal events			
			Fan 1 error (the actual fan speed is outside the desired speed)
			Fan 2 error (the actual fan speed is outside the desired speed)
			Fan 3 error (the actual fan speed is outside the desired speed)
			Fan 4 error (the actual fan speed is outside the desired speed)
			Temperature 1 error (over limited temperature)

	 : Off	 : Orange On	 : Green On	 : Red On
		 : Orange Flashing	 : Green Flashing	 : Red Flashing

Troubleshooting

? The projector does not turn on.

Cause	Remedy
There is no power from the power cord.	Plug the power cord into the AC power jack on the projector, and plug the power cord into the power outlet. If the power outlet has a switch, make sure that it is switched on.
Attempting to turn the projector on again during the cooling process.	Wait until the cooling down process has completed.

? No picture

Cause	Remedy
The video source is not turned on or connected correctly.	Turn the video source on and check that the signal cable is connected correctly.
The projector is not correctly connected to the input signal device.	Check the connection.
The input signal has not been correctly selected.	Select the correct input signal with the SOURCE key.
The lens cover is still closed.	Open the lens cover.

? Blurred image

Cause	Remedy
The projection lens is not correctly focused.	Adjust the focus of the lens using the focus ring.
The projector and the screen are not aligned properly.	Adjust the projection angle and direction as well as the height of the projector if necessary.
The lens cover is still closed.	Open the lens cover.

? Remote control does not work.

Cause	Remedy
The batteries are out of power.	Replace both of the batteries with new ones.
There is an obstacle between the remote control and the projector.	Remove the obstacle.
You are too far away from the projector.	Stand within 8 meters (26 feet) of the projector.

? The password is incorrect.

Cause	Remedy
You do not remember the password.	See Entering the password recall procedure on page 20.

Specifications

Projector specifications



All specifications are subject to change without notice.

Optical

Resolution

3840 x 2160 with XPR
1920 x 1080 without XPR

Display system

1-CHIP DMD

Lens

F = 1.9 ~ 2.47, f = 12 ~ 15.6 mm

Clear focus range

1.2m ~ 5.1m @ Wide,
1.3m ~ 4.9m @ Tele

Lamp

245 W lamp

Zoom ratio

1.3X

Electrical

Power supply

AC100–240V, 3.4 A, 50–60 Hz (Automatic)

Power consumption

350 W (Max); 0.5 W (Standby)

Mechanical

Weight

4.2 Kg ± 200 g (9.3 lbs ± 0.44 lbs)

Output terminals

Speaker

5 watt x 2

Audio signal output

PC audio jack x 1
SPDIF to optical x 1

Control

USB

Type-A (USB 3.0) x 1: Media reader/drive,
Firmware download (5V 1.5A)
Type-A (USB 2.0) x 1: Power supply (5V, 2.5A)
Mini-B x 1

12V DC x 1: Trigger for screen control

RS-232 serial control

9 pin x 1

IR receiver x 2

Input terminals

Video signal input

HDMI (2.0b, HDCP 2.2) x 2

Environmental Requirements

Operating temperature

0°C–40°C at sea level

Operating relative humidity

10%–90% (without condensation)

Operating altitude

0–1499 m at 0°C–35°C

1500–3000 m at 0°C–30°C (with

High Altitude Mode on)

Storage temperature

-20°C–60°C at sea level

Storage humidity

10%–90% RH (without condensation)

Storage altitude

30°C@ 0~12,200m above sea level

Transporting

Original packing or equivalent is recommended

Repairing

Please visit below website and choose your country to
find your service contact window.

<http://www.benq.com/welcome>

Dimensions

380 mm (W) x 127 mm (H) x 264 mm (D)

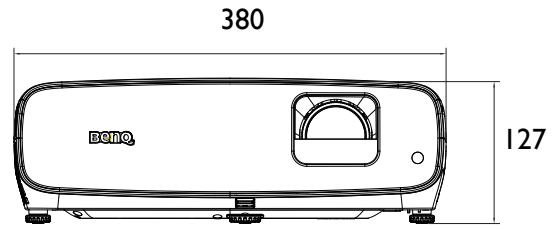
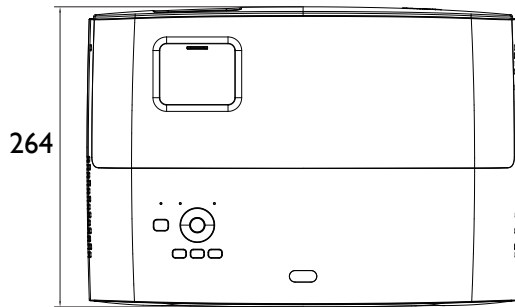

Unit: mm

Timing chart

Supported timing for HDMI (HDCP) input

- PC timings

Resolution	Mode	Vertical Frequency (Hz)	Horizontal Frequency (kHz)	Pixel Frequency (MHz)	Supported 3D format	
					Top Bottom	Side by Side
640 x 480	VGA_60	59.940	31.469	25.175		
	VGA_72	72.809	37.861	31.500		
	VGA_75	75.000	37.500	31.500		
	VGA_85	85.008	43.269	36.000		
720 x 400	720 x 400_70	70.087	31.469	28.3221		
800 x 600	SVGA_60	60.317	37.879	40.000		
	SVGA_72	72.188	48.077	50.000		
	SVGA_75	75.000	46.875	49.500		
	SVGA_85	85.061	53.674	56.250		
1024 x 768	SVGA_120 (Reduce Blanking)	119.854	77.425	83.000		
	XGA_60	60.004	48.363	65.000	V	V
	XGA_70	70.069	56.476	75.000		
	XGA_75	75.029	60.023	78.750		
	XGA_85	84.997	68.667	94.500		
1024 x 768	XGA_120 (Reduce Blanking)	119.989	97.551	115.5		
1152 x 864	1152 x 864_75	75	67.5	108		
1024 x 576@60Hz	BenQ Notebook Timing	60.00	35.820	46.996		
1024 x 600@65Hz	BenQ Notebook Timing	64.995	41.467	51.419		
1280 x 720	1280 x 720_60	60	45.000	74.250	V	V
1280 x 768	1280 x 768_60	59.870	47.776	79.5	V	V
1280 x 800	WXGA_60	59.810	49.702	83.500	V	V
	WXGA_75	74.934	62.795	106.500		
	WXGA_85	84.880	71.554	122.500		
	WXGA_120 (Reduce Blanking)	119.909	101.563	146.25		
1280 x 1024	SXGA_60	60.020	63.981	108.000	V	V
	SXGA_75	75.025	79.976	135.000		
	SXGA_85	85.024	91.146	157.500		
1280 x 960	1280 x 960_60	60.000	60.000	108	V	V
	1280 x 960_85	85.002	85.938	148.500		
1360 x 768	1360 x 768_60	60.015	47.712	85.500	V	V
1440 x 900	WXGA+_60	59.887	55.935	106.500	V	V
1400 x 1050	SXGA+_60	59.978	65.317	121.750	V	V
1600 x 1200	UXGA	60.000	75.000	162.000	V	V
1680 x 1050	1680 x 1050_60	59.954	65.290	146.250	V	V
640 x 480@67Hz	MAC13	66.667	35.000	30.240		
832 x 624@75Hz	MAC16	74.546	49.722	57.280		
1024 x 768@75Hz	MAC19	75.020	60.241	80.000		
1152 x 870@75Hz	MAC21	75.06	68.68	100.00		
1920 x 1080@60Hz	1920 x 1080_60	60	67.5	148.5	V	V
1920 x 1200@60Hz	1920 x 1200_60 (Reduce Blanking)	59.95	74.038	154	V	V
1920 x 1080@120Hz	1920 x 1080_120 (Only HDMI 2.0 support)	120.000	135.000	297		
3840 x 2160	3840 x 2160_30 For 4K2K model	30	67.5	297		
3840 x 2160	3840 x 2160_60 For 4K2K model (Only HDMI 2.0 support)	60	135	594		



The timings showing above may not be supported due to EDID file and VGA graphic card limitations. It is possible that some timings cannot be chosen.

• Video timings

Timing	Resolution	Horizontal Frequency (kHz)	Vertical Frequency (Hz)	Dot Clock Frequency (MHz)	Supported 3D format		
					Frame Packing	Top Bottom	Side by Side
480i	720 (1440) x 480	15.73	59.94	27			
480p	720 x 480	31.47	59.94	27			
576i	720 (1440) x 576	15.63	50	27			
576p	720 x 576	31.25	50	27			
720/50p	1280 x 720	37.5	50	74.25	V	V	V
720/60p	1280 x 720	45.00	60	74.25	V	V	V
1080/24P	1920 x 1080	27	24	74.25	V	V	V
1080/25P	1920 x 1080	28.13	25	74.25			
1080/30P	1920 x 1080	33.75	30	74.25			
1080/50i	1920 x 1080	28.13	50	74.25			V
1080/60i	1920 x 1080	33.75	60	74.25			V
1080/50P	1920 x 1080	56.25	50	148.5		V	V
1080/60P	1920 x 1080	67.5	60	148.5		V	V
2160/24P	3840 x 2160 (Only HDMI 2.0 support)	54	24	297			
2160/25P	3840 x 2160 (Only HDMI 2.0 support)	56.25	25	297			
2160/30P	3840 x 2160 (Only HDMI 2.0 support)	67.5	30	297			
2160/50P	3840 x 2160 (Only HDMI 2.0 support)	112.5	50	594			
2160/60P	3840 x 2160 (Only HDMI 2.0 support)	135	60	594			

Color Depth Table

Display format (refresh rate)	Chroma subsampling	8 Bit	10 Bit	12 Bit
4K/60p (60 Hz)	04:04:04	Yes	No	No
	04:02:02	Yes	Yes	Yes
	04:02:00	Yes	Yes	Yes
4K/24p (24 Hz)	04:04:04	Yes	Yes	Yes
	04:02:02	Yes	Yes	Yes
	04:02:00	Yes	Yes	Yes