



BH240I/BH280I/BH350I
BH380I/BH380ID/BH280IN
BH380IN
LCD Monitor
User Manual



Disclaimer

BenQ Corporation makes no representations or warranties, either expressed or implied, with respect to the contents of this document. BenQ Corporation reserves the right to revise this publication and to make changes from time to time in the contents thereof without obligation to notify any person of such revision or changes.

Copyright

Copyright 2019 BenQ Corporation. All rights reserved. No part of this publication may be reproduced, transmitted, transcribed, stored in a retrieval system or translated into any language or computer language, in any form or by any means, electronic, mechanical, magnetic, optical, chemical, manual or otherwise, without the prior written permission of BenQ Corporation.

Product support

This document aims to provide the most updated and accurate information to customers, and thus all contents may be modified from time to time without prior notice. Please visit the website for the latest version of this document and other product information. Available files vary by model.

1. Make sure your computer is connected to the Internet.
2. Visit the local website from www.BenQ.com. The website layout and content may vary by region/country.
 - User manual and related document: www.BenQ.com > **Business** > **SUPPORT** > **Downloads** > model name > **User Manual**
 - (EU only) Dismantled information: Available on the user manual download page. This document is provided based on Regulation (EU) 2019/2021 to repair or recycle your product. Always contact the local customer service for servicing within the warranty period. If you wish to repair an out-of-warranty product, you are recommended to go to a qualified service personnel and obtain repair parts from BenQ to ensure compatibility. Do not disassemble the product unless you are aware of the consequences. If you cannot find the dismantled information on your product, contact the local customer service for assistance.

Table of Contents

Product support.....	3
Safety warnings and precautions.....	6
Important safety instructions.....	7
Notes on the LCD panel of this display	7
Safety notice for remote control	8
BenQ ecoFACTS.....	9
Package contents	10
Setting up the display.....	11
Mounting the display	11
Parts of the display and their functions.....	13
Front panel	13
Rear panel.....	13
Bottom panel	13
Input/output terminals	15
Remote control.....	16
Using the remote control	17
Connection	18
Connecting audio/video signals.....	18
Connecting the digital inputs.....	18
Connecting the RS-232 input.....	18
Connecting power	19
Basic operations.....	20
Turning the display on or off.....	20
Switching input signals.....	20
Adjusting audio volume level.....	21
Operations in the OSD menu.....	22
Initial setup	23
System Update.....	23
Multimedia buttons on the remote control	24
Android System Interface	25
Setting up the Internet connection.....	30
Menu operations.....	32
Control Action	32

Setting menu	32
Input settings (Android)	32
Input settings (HDMI).....	39
Product information.....	41
Specifications	41
X-Sign content compatibility.....	44
USB device compatibility	44
Dimensions	47
Supported input signal resolution.....	57
Troubleshooting	58

Safety warnings and precautions



The lightning flash with arrowhead symbol, within an equilateral triangle, is intended to alert the user to the presence of uninsulated "dangerous voltage" within the product's enclosure that may be of sufficient magnitude to constitute a risk of electric shock to persons.



The exclamation point within an equilateral triangle is intended to alert the user to the presence of important operating and maintenance (servicing) instructions in the literature accompanying the appliance.



THIS EQUIPMENT MUST BE GROUNDED

To ensure safe operation, the three-pin plug must be inserted only into a standard three-pin power outlet which is effectively grounded through normal household wiring. Extension cords used with the equipment must have three cores and be correctly wired to provide connection to the ground. Wrongly wired extension cords are a major cause of fatalities.

The fact that the equipment operates satisfactorily does not imply that the power outlet is grounded or that the installation is completely safe. For your safety, if you are in any doubt about the effective grounding of the power outlet, please consult a qualified electrician.

- The mains plug of the power supply cord shall remain readily operable. The AC receptacle (mains socket outlet) shall be installed near the equipment and shall be easily accessible. To completely disconnect this equipment from the AC mains, disconnect the power cord plug from the AC receptacle.
- Do not place this display on an uneven, sloping or unstable surface (such as a trolley) where it may fall and cause damage to itself or others.
- Do not place this display near water, like a spa or pool, or in a position which will allow the splashing or spraying of water onto the display, like in front of an open window where rain water may enter.
- Do not install this display in a confined space without proper ventilation and air circulation, such as in a closed cabinet. Allow proper space around the display for dissipating heat inside. Do not block any openings and vents on the display. Overheating may result in hazards and electric shock.
- Installation of this display should only be performed by a qualified technician. Failure to install this display properly may cause injuries and damages to the personnels and the display itself. Check the installation regularly and maintain the display periodically to ensure the best working condition.
- Use only the accessories approved or recommended by the manufacturer to mount this display. Using wrong or unsuitable accessories may cause the display to fall and result in serious personal injuries. Make sure that the surface and fixing points are strong enough to sustain the weight of the display.
- To reduce the risk of electric shock, do not remove covers. No user serviceable parts inside. Refer servicing to qualified service personnel.
- To prevent personal injuries, mounting the display or installing desktop stands is required before use.

Important safety instructions

1. Read these instructions.
2. Keep these instructions.
3. Heed all warnings.
4. Follow all instructions.
5. Do not use this apparatus near water.
6. Clean only with dry cloth.
7. Do not block any ventilation openings. Install in accordance with the manufacturer's instructions.
8. Do not install near any heat sources such as radiators, heat registers, stoves, or other apparatus (including amplifiers) that produce heat.
9. Do not defeat the safety purpose of the polarized or grounding-type plug. A polarized plug has two blades with one wider than the other. A grounding-type plug has two blades and a third grounding prong. The wide blade or the third prong are provided for your safety. If the provided plug does not fit into your outlet, consult an electrician for replacement of the obsolete outlet.
10. Protect the power cord from being walked on or pinched particularly at plugs, convenience receptacles, and the point where they exit from the apparatus.
11. Only use attachments/accessories specified by the manufacturer.
12. Use only with the cart, stand, tripod, bracket, or table specified by the manufacturer, or sold with the apparatus. When a cart is used, use caution when moving the cart/apparatus combination to avoid injury from tip-over.
13. Unplug this apparatus during lightning storms or when unused for long periods of time.
14. Refer all servicing to qualified service personnel. Servicing is required when the apparatus has been damaged in any way, such as power-supply cord or plug is damaged, liquid has been spilled or objects have fallen into the apparatus, the apparatus has been exposed to rain or moisture, does not operate normally, or has been dropped.



Notes on the LCD panel of this display

- The Liquid Crystal Display (LCD) panel of this display has a very thin protective layer of glass which is liable to marking or scratching, and cracking if struck or pressured. The liquid crystal substrate is also liable to damage under excessive force or extreme temperatures. Please handle with care.
- The response time and brightness of the LCD panel may vary with the ambient temperature.
- Avoid placing the display in direct sun or where direct sun or spot lighting will shine onto the LCD panel, as the heat may damage the panel and the external casing of the display, and the bright light will make viewing the display more difficult than necessary.
- The LCD panel consists of individual pixels to display images and is manufactured according to the design specifications. While 99.9% of these pixels work normally, 0.01% of the pixels may remain constantly lit (in red, blue or green) or unlit. This is a technical limitation of the LCD technology and is not a defect.
- LCD screens, like plasma (PDP) and conventional CRT (Cathode Ray Tube) screens, are also susceptible to 'screen burn-in' or 'image retention' which can be found on the

screen as visible fixed lines and shades. To avoid such damage to the screen, avoid displaying still images (like On-Screen Display menus, TV station logos, fixed/inactive text or icons) for more than two hours. Change the aspect ratio from time to time. Fill the entire screen with the image and eliminate the black bars whenever possible. Avoid displaying images in 4:3 aspect ratio over a long period of time, otherwise there may be visible burn marks on the screen as two vertical lines.

Note: Under certain circumstances, condensation may occur on the inner side of the cover glass, it's a natural phenomenon and will not affect the operation of the display. This condensation will usually disappear after around 30 minutes of normal operation.

- If display of a still image is required, it is recommended that the “Anti-Image Retention” function is enabled under the **Initial Setting** menu.

Safety notice for remote control

- Do not put the remote control in the direct heat, humidity, and avoid fire.
- Do not drop the remote control.
- Do not expose the remote control to water or moisture. Failure to do so could result in malfunction.
- Confirm there is no object between the remote control and the remote sensor of the product.
- When the remote control will not be used for an extended period, remove the batteries.

BenQ ecoFACTS

BenQ has been dedicated to the design and development of greener product as part of its aspiration to realize the ideal of the “Bringing Enjoyment 'N Quality to Life” corporate vision with the ultimate goal to achieve a low-carbon society. Besides meeting international regulatory requirement and standards pertaining to environmental management, BenQ has spared no efforts in pushing our initiatives further to incorporate life cycle design in the aspects of material selection, manufacturing, packaging, transportation, using and disposal of the products. BenQ ecoFACTS label lists key eco-friendly design highlights of each product, hoping to ensure that consumers make informed green choices at purchase. Check out BenQ's CSR Website at <http://csr.BenQ.com/> for more details on BenQ's environmental commitments and achievements.



Package contents

Open the sales package and check the contents. If any item is missing or damaged, please contact your dealer immediately.

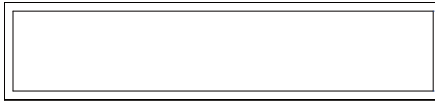

BH2801/BH2801N



BH3801/BH3801D/BH3801N

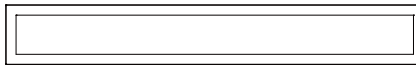

BH2401

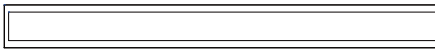

BH3501

LCD display



Remote control

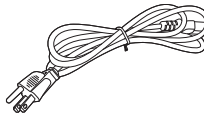

Power cord
(By region)

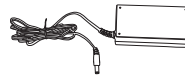

Adapter



HDMI cable



Quick start guide



Warranty Card
(By region)

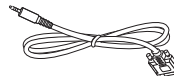

RS232 cable



AAA battery x 2



- The type of power cord supplied may differ from that illustrated depending on your region of purchase.
- Before discarding the package, check that you haven't left any accessories inside the box.
- Dispose of packaging materials wisely. You can recycle the cardboard carton. Consider storing the package (if possible) for future transport of the display.
- Do not leave plastic bags within reach of young children or babies.

Setting up the display

Mounting the display

You can install the display on a vertical surface with a suitable wall mounting bracket or on a horizontal surface with the optional desktop stands. Please pay attention to the following notes during installation:

- This display should be installed by at least two adult persons. Attempting to install this display by only one person may result in danger and injuries.
- Refer the installation to qualified technicians. Improper installation may cause the display to fall or malfunction.

Installing the display on a wall

1. Place a clean, dry and lint-free cloth on a flat, horizontal and object-free surface. Make sure that the size of the cloth is larger than the display.
2. Gently lay the display on the cloth with the LCD screen facing down.
3. Remove the desktop stands from the display if installed.

4. Identify the wall mounting screw holes on the back of the display as shown in the illustration.

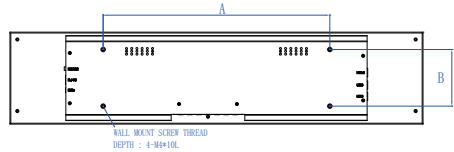

*Screw type: M4*10L

5. All models support both landscape and portrait installation.

BH2801/BH3801: 400mm (A) x 100mm (B)

BH2801N/BH3801N: 400mm (A) x 100mm (B)

BH2401/ BH3501: 430mm (A) x 60mm (B)

BH3801D

Please make sure the I/O side is facing down during landscape installation. Incorrect installation may cause heat dissipation issue.

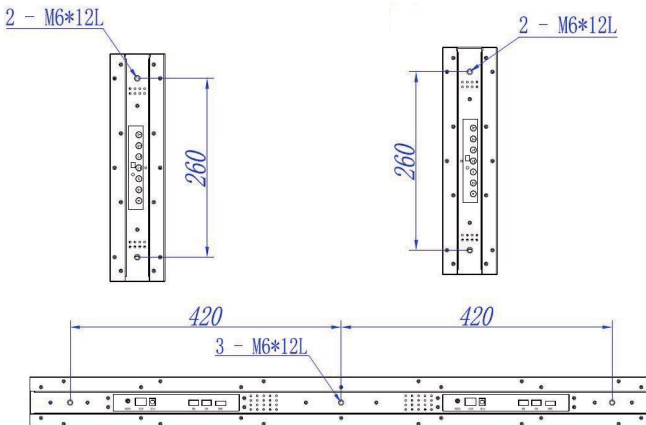

*Screw type: M6*12L

6. Install the wall mounting bracket on the display and attach the display to the wall according to the mounting bracket's instructions. The length of the screw should exceed the thickness of the wall mounting bracket by at least 12 mm. Make sure that all screws are tightened and secured properly. (Recommended torque: 9 - 10Kg•cm). The mounting means should be strong enough to bear the weight of the display.

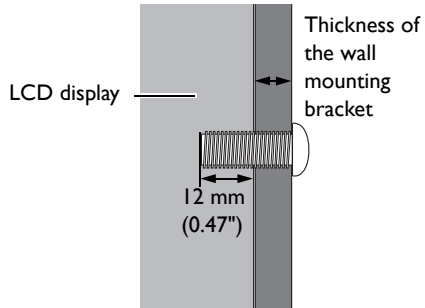

- To maintain proper ventilation, keep at least 10 mm of clear space from the back cover of the display to the wall.
- Please consult a professional technician for wall mount installations. The manufacturer accepts no liability for installations not performed by a professional technician.

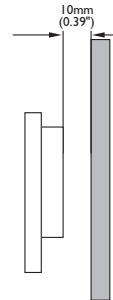

- The AC IN/OUT socket should be on the bottom of the unit when rotating your display.

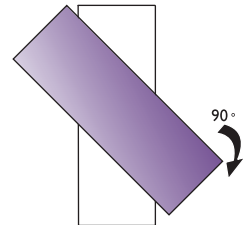

Parts of the display and their functions

Front panel

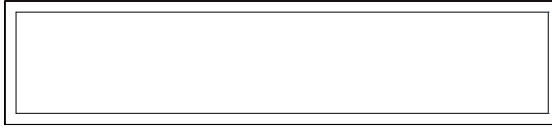

BH2801/BH2801N



BH3801/BH3801D/BH3801N

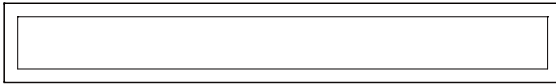

BH2401

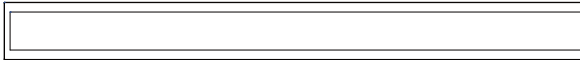

BH3501

Rear panel

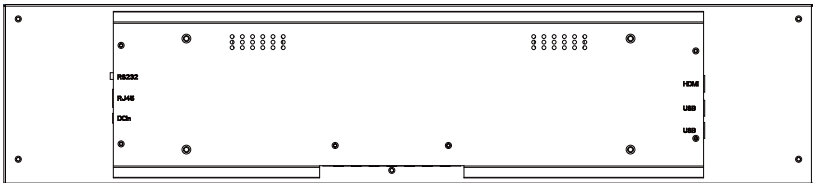

Bottom panel

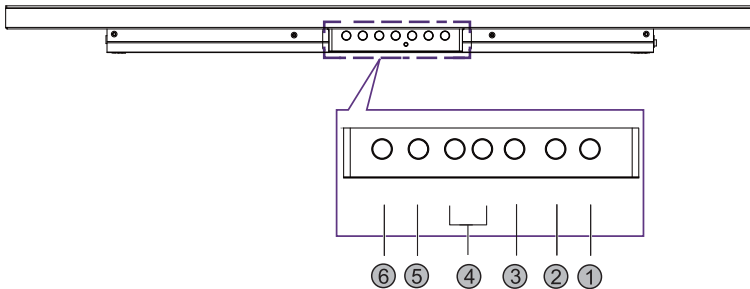

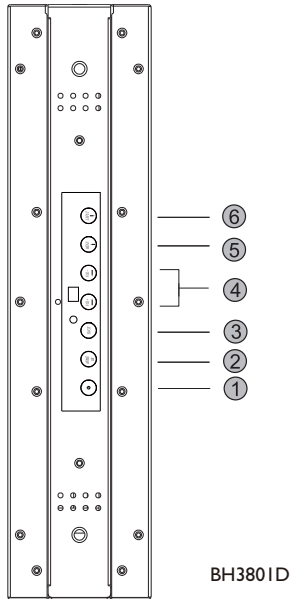

No.	Name	Default Function	Alternative Function
1	Power	Power ON/OFF. Press for 5 seconds to fully power off the display.	NA
2	HOME	OK. Enter the next level.	Home. Go back to main launcher.
3	BACK	Back. Return to the previous level.	NA
4	Volume up/ Volume down	Select Right/ Left. Select different item.	Increase/ Decrease volume.
5	MENU	Scroll up. Select different item.	Menu. Open or close OSD menu.
6	INPUT	Scroll down. Select different item.	Input. Switch between input sources.



Press INPUT for 10 seconds to switch between default and alternative key function.

Input/output terminals

BH240I / BH280I /
BH350I / BH380I /
BH280IN / BH380IN

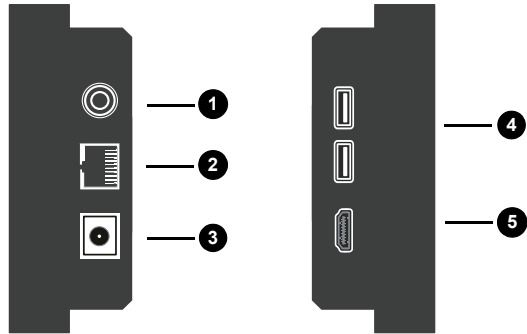

BH380ID



No.	Name	Description
1	RS232 (3.5mm)	Receives control signals from a computer or another display.
2	RJ45	Connects to the RJ-45 port on your Ethernet or router.
3	DC IN	Connects to a power outlet via the supplied power cord and adapter.
4	USB (2.0)	Accesses multimedia files on USB drives directly.
5	HDMI	Receives HDMI signals from an external device (such as a Blu-ray disc player).

Remote control

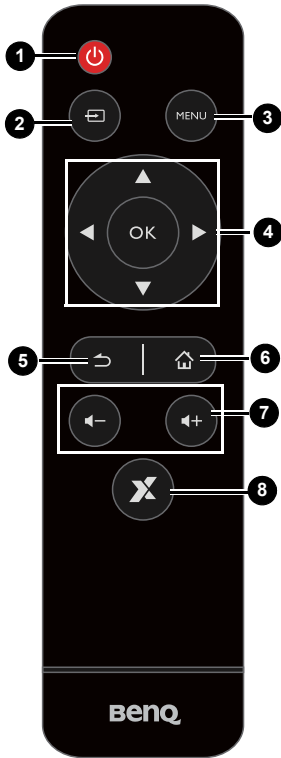

1 Power button

Turn the display on or off.

2 INPUT

Selects an input source.

3 MENU

Opens or closes the OSD menu.

4 ▲/▼/◀/▶/OK

Scrolls through settings and options in the OSD menu when the OSD menu is on.

5 BACK

Return key.

6 HOME

Android system main screen button.

7 Volume +/-

Turns up/down the volume.

8 X-Sign

Opens the X-Sign app in Android.

Using the remote control

Installing remote control batteries

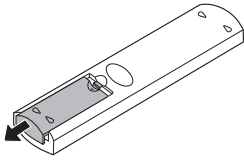

1. Open the remote control battery compartment cover.

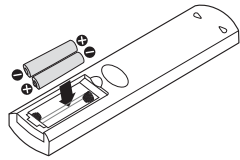

2. Insert the batteries ensuring that the positive and negative marked battery terminals match the (+) and (-) marks in the battery compartment.



Batteries must be purchased separately as they are not included in the display package.

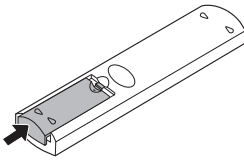

3. Refit the battery compartment cover.

Remote control usage tips

- Point and aim the top front of the remote control directly at the display's remote control sensor window when you press the buttons.
- Do not let the remote control become wet or place it in humid environments (like bathrooms).
- If the display's remote control sensor window is exposed to direct sunlight or strong light, the remote control may not operate properly. In this situation, change the light source, readjust the angle of the display or operate the remote control from a location closer to display's remote control sensor window.

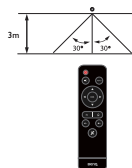
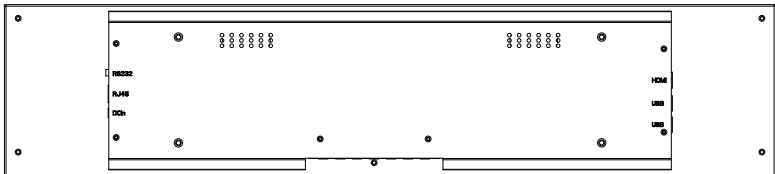

Connection

Connecting audio/video signals

Pay attention to the following notes when you connect cables:

- Please turn off all devices.
- Familiarize yourself with the audio/video ports on the display and the devices you want to use. Be aware that incorrect connections may adversely affect picture quality.
- Do not remove cables from the ports by pulling the cable itself. Always grasp and pull the connectors at the end of the cable.
- Ensure that all cables are fully inserted and firmly seated.

Connecting the digital inputs

1. Connect the HDMI output jack of a computer to the **HDMI** input jack on the display using an HDMI cable.
2. To view images from this input, press the **INPUT** button on the remote control.

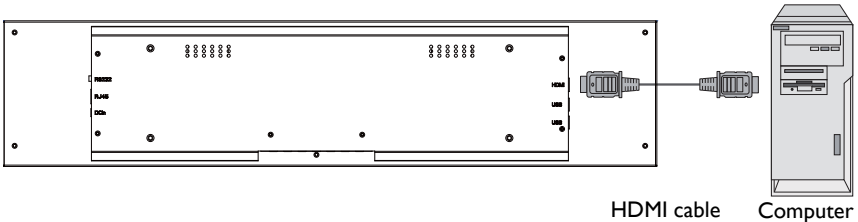

Connecting the RS-232 input

You can connect a computer to the display via the RS-232 to send commands from the computer to the display.

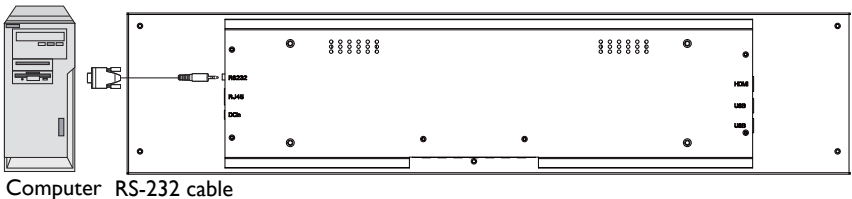

- This connection is applicable to straight-through RS-232 direct cable only.
- After using serial port line to connect central control equipment and machine, certain function of the machine can be controlled via central control equipment, such as: machine on/off, and adjustment of sound volume, etc.

Connecting power

1. Plug the adapter into the **DC IN** jack on the display.
2. Plug one end of the power cord into the adapter and the other end into an appropriate power outlet (if the outlet is switched, turn on the switch).
3. The power indicator on the bottom panel of the display will light up red then green, and the display will automatically power on.
4. BH3801D has two power cords. Please connect both of them for the double side application.

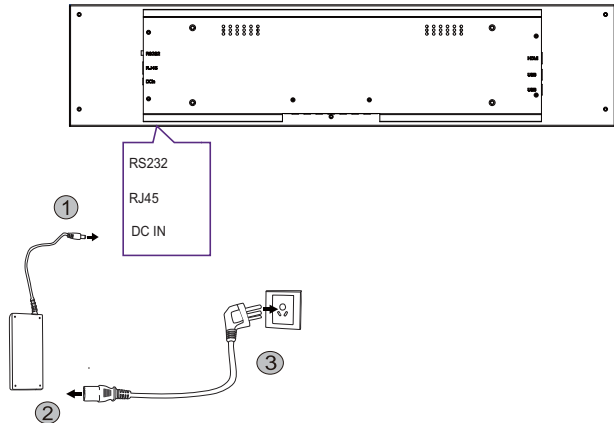

- The supplied power cord is suitable for use with 100-240V AC power only.
- The power cord and outlet illustrated may differ from the ones used in your region.
- Only use an appropriate power cord for your region. Never use a power cord which appears damaged or frayed, or change the plug type on the power cord.
- Be aware of the power loading when you use extension cords or multiple outlet power boards.
- There are no user serviceable parts in this display. Never unscrew or remove any covers. There are dangerous voltages inside the display. Turn off the power and unplug the power cord if you intend to move the display.
- Warning: For BH3801D, disconnect both supply cords before servicing.

Basic operations

Turning the display on or off

To turn on the display, press the power button on the display's control panel or on the remote control.



The display's standby mode still consumes power. To completely cut off power supply, disconnect the power cord from the power outlet.

Switching input signals

Press the **INPUT** button on the remote control or the **INPUT** button on the control panel to select an input signal.



If an input source has been previously selected, the display will automatically select that input source when it is turned on.

Playing media files

There are three ways to play the content.

X-Sign

To play content from X-Sign app. Switch the input to Android system, and select X-Sign app. The X-sign content must match the resolution of the display, and the video is recommended to use H.265 in avi/ mkv/ mp4 format. Please refer to [X-Sign content compatibility on page 44](#) and X-sign user manual for detailed information.

USB drive

To play media files stored on a USB flash drive, insert the flash drive to the USB port located on the rear panel, then press the **INPUT** button on the remote control or the **INPUT** button on the control panel and select Android from the input menu. Play picture/ song/ video via **MultiMedia**. Please make sure that the content resolution matches the display resolution (refer to [X-Sign content compatibility on page 44](#) for the resolution table). For more information regarding Multimedia, please refer to [Multimedia on page 25](#).

HDMI

To play content from HDMI source, connect the HDMI cable to the source directly, or switch HDMI input manually. In default I:I mode, it will display the upper section of the input source. Please make sure the upper section of the input source matches the display resolution (refer to [X-Sign content compatibility on page 44](#) for the resolution table).

The zoom mode is only for the scenario that the whole input source needs to be displayed. The zoom mode can be changed in **Setting > Device > Display**.







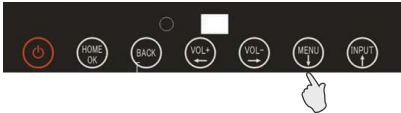

- I:I mode: BH3801 only shows the upper section (1920x600) from the 1920x1080 source. BH2801 only shows the upper section (1920x360) from the 1920x1080 source. BH2401 only shows the upper section (1920x190) from the 1920x1080 source. BH3501 only shows the upper section (1920x130) from the 1920x1080 source.
 - FULL mode: It will size in the whole HDMI source screen into the display.
-

Adjusting audio volume level

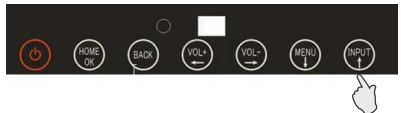
- To adjust the audio volume level, press **Volume +/-** on the remote control or press **Volume up / Volume down** on the front panel of the display.
- Go to **Setting > Audio** to adjust the volume. Refer to [Audio settings \(Android\) on page 33](#) for more information.

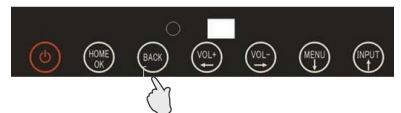
Operations in the OSD menu

Using the control panel buttons	Using the remote control
<p>1. Press MENU to open the OSD menu.</p> 	<p>1. Press MENU to open the OSD menu.</p> 
<p>2. Press ▼ or ▲ to select an item.</p> 	
<p>3. Press INPUT to confirm selections.</p> 	<p>3. Press OK to confirm selections.</p> 
<p>4. Press ▼ or ▲ to select a feature and press ◀ or ▶ to adjust settings. Press OK to save changes.</p> 	
<p>5. Press Back to close the OSD menu.</p> 	<p>5. Press MENU to close the OSD menu.</p> 

Initial setup

After you have connected the display to the power, you are ready to power on the display. The first time you power on the display, you will be guided through a series of setup screens. Follow the on-screen instructions or the steps below to start up your display and complete the initial setup.

1. Turn on the display. Wait for the display to boot up with the BenQ screen. This may take a moment.
2. Tap **Next** on the screen to begin. Follow the on-screen instructions to set up the language, date and time, and network. Or you can skip some of these steps and complete the setup later.

System Update

Whenever a new version of software is available, the system will automatically detect the update and will prompt you to download it every time you launch the system. For manual update, go to **System > About > System update**. For more information about

System update, please see [System settings \(Android\) on page 36](#).

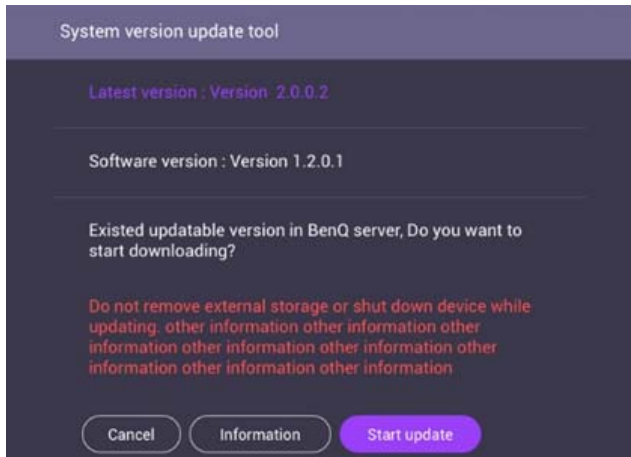

Software update process may take some time to complete. During the update process, do not turn off the device/ disconnect the Internet/ remove USB drive. Any interruptions during the software update process may permanently damage your display.

Multimedia buttons on the remote control

To operate the multimedia system, use the buttons on the remote control.

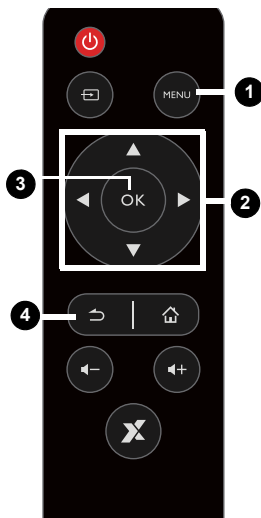

No.	Name	Description
1	MENU	Switches to the OSD menu.
2	▲/▼/◀/▶	Directional buttons for selecting a desired item.
3	OK	Selects/deselects a menu item.
4	BACK	Goes back to the previous screen.

Android System Interface

X-Sign

Switch the input to Android system, and select X-Sign app. For more information about X-Sign, please refer to X-Sign user manual.

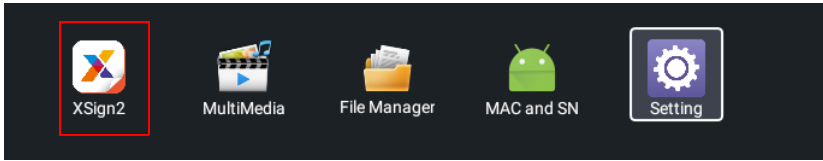

Multimedia

- Multimedia files such as images, audio files, and videos can be played by clicking on the icon.

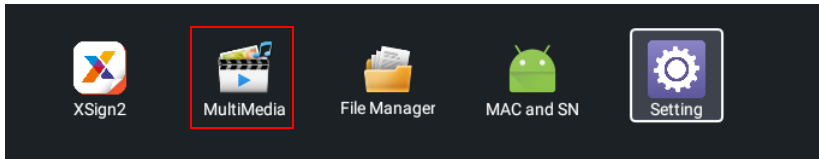

- Select **all** or the corresponding file type on the left side to see the file type you want to play.

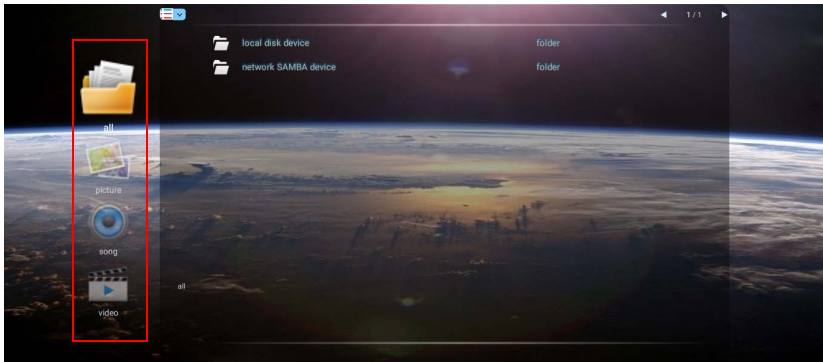

Picture

Select a file you want to show on the display and perform any of the functions shown on the screen.



Icon	Function
	Play the previous image.
	Play/pause the current playback.
	Play the next image.
	Magnify the current image.
	Shrink the current image.
	Rotate the current image counter-clockwise.
	Rotate the current image clockwise.
	See the information about the file name, creation time, file size, and the file format.
	Without function.
	Playing settings. <ul style="list-style-type: none"> • Animation effect is without function. • You can select playing interval time.









Supported image format (max resolution):

- JPEG (base-line up to 8K x 8K, progressive up to 4K x 4K)
- PNG (8K x 8K)
- BMP (8K x 8K)
- GIF (4K x 4K)

Song

Select an audio file you want to play and perform any of the functions shown on the screen.



Icon	Function
	Play the previous audio file.
	Play/pause the current playback.
	Play the next audio file.
	<ul style="list-style-type: none"> • Repeatedly play one audio file in the playlist. • Repeatedly play the whole audio files in the playlist. • Shuffle Play. The audio files play in a random order.
	Check audio files in the playlist.
	See the information about the file name, file duration, artist name, file format, audio codec, and the file path.



Supported audio format (codec):

- wma (WMA/WMAPro: 128Kbps~320Kbps, 8KHz~48KHz sampling rate)
- mp3 (MPEG Layer 3: 32Kbps~320Kbps, 32KHz~48KHz sampling rate)
- wav (PCM: Max 320Kbps, Max 48kHz sampling rate / ADPCM: 384Kbps, 8KHz ~ 48KHz sampling rate)
- m4a (ACC: 24kbps ~ 384kbps, 16KHz~48KHz sampling rate)
- ogg (Vorbis: Max 320Kbps, 8KHz~48KHz sampling rate)

Video

Select a video file you want to play on the display and perform any of the functions shown on the screen.



Icon	Function
	Play the previous video file.
	Fast rewind the current video.
	Play/pause the current playback.
	Fast forward the current video.
	Play the next video file.
	Playing progress.
	Check video files in the playlist.
	See the information about the file name, file duration, file size, file format, audio codec, and video codec.
	<ul style="list-style-type: none"> Repeatedly play one video file in the playlist. Repeatedly play the whole video files in the playlist.
	<ul style="list-style-type: none"> Shuffle Play. The video files play in a random order.



Supported video format (codec) up to 4K resolution:

- 3gp (H.264 MP, HP@Level 4.1, H263, MPEG-4 SP@L0-3, ASP@L0-5)
- avi (MPEG-1, MPEG-2 MP@HL, MPEG-4 SP@L0-3, ASP@L0-5, H.264, MP, HP@Level 4.1, H263, VP6, MJPEG)
- mkv (VP9, H.265)
- mov (MPEG-4 SP@L0-3, ASP@L0-5, MJPEG, H.264 MP, HP@Level 4.1, H265)
- mp4 (MPEG-4 SP@L0-3, ASP@L0-5, H.264 MP, HP@Level 4.1, H265)
- mpg, mpeg (MPEG-1, MPEG-2 MP@HL, H.264 MP, HP@Level 4.1)
- ts (MPEG-2 MP@HL, MPEG-4 SP@L0-3, ASP@L0-5, H.264 MP, HP@Level 4.1, VC1 AP, H265)

File Manager

File Manager can only manage files. To play pictures, songs, or videos, use Multimedia.

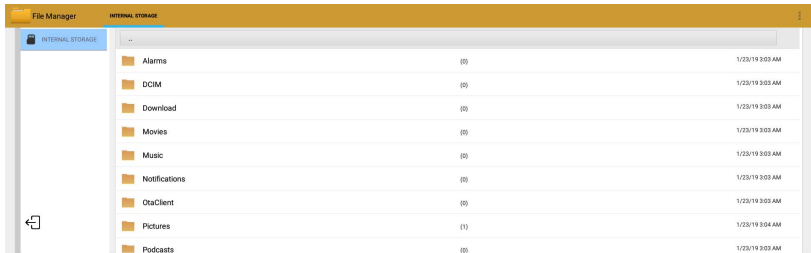
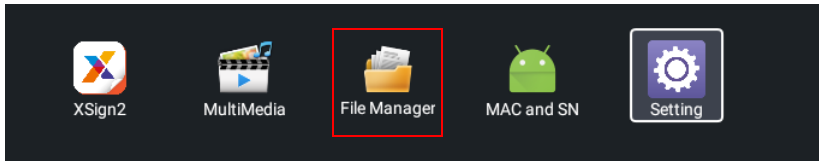

MAC & SN

Check the MAC address and serial number.

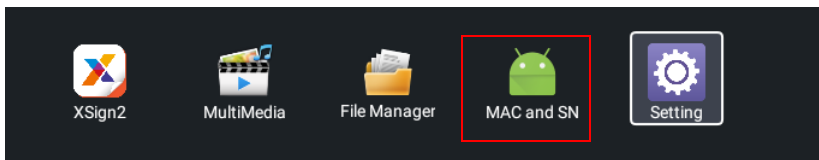

Setting

Refer to [Setting menu on page 32](#) for more information.

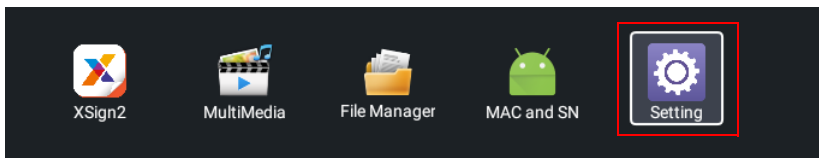

Setting up the Internet connection

Your display must be connected to a network to conduct OTA updates or surf the Internet.



To find the MAC address in Android OS, please go to **Setting > System > About > Status**.

Network setting

Go to **Network > Ethernet**. If there is no IP address shown, please connect the display to the ethernet cable.

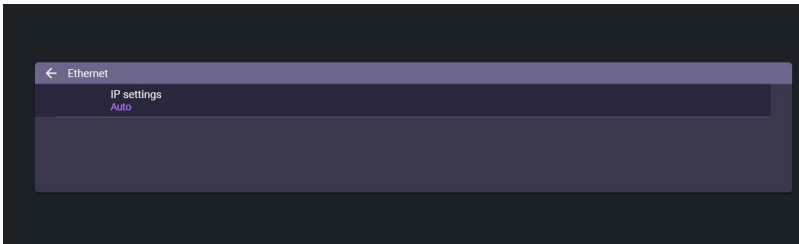
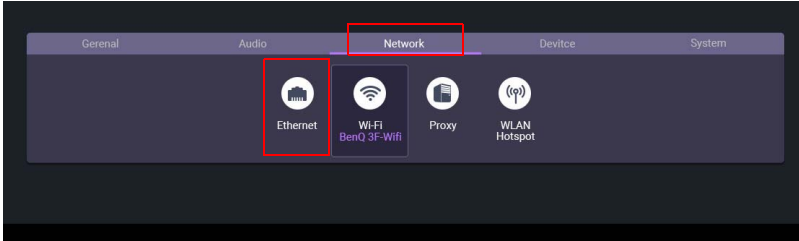

Wireless connection

1. Go to **Network > Wi-Fi**.

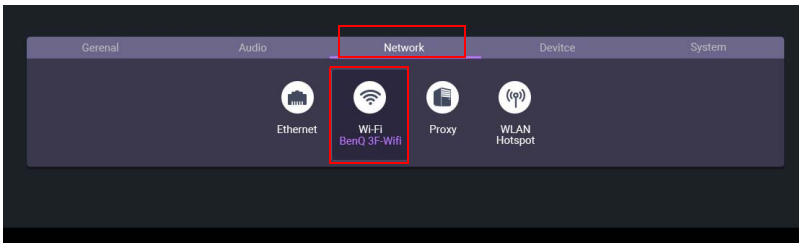

2. Set the switcher to **On**. A list of available networks will show on the screen.

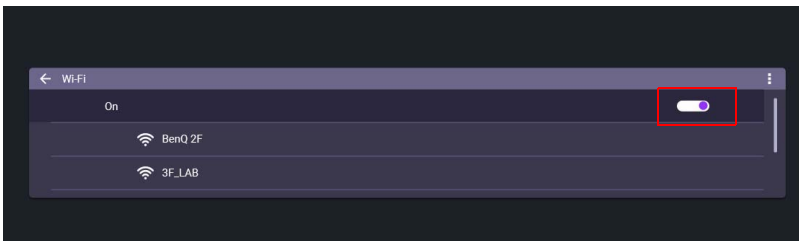

- Press **▲/▼/◀/▶** on the remote control to select the network's name and connect to the network. The password is needed if it is your first time to use the network. Key in the password and press **Connect**. The device is now connected to the WLAN.



- Please make sure your Wi-Fi dongle is approved by BenQ.
- Ethernet will be disabled automatically if Wi-Fi turns on and connects to a network.
- For wireless connection, BenQ shipment does not include wireless dongles, therefore, you may purchase it separately via the local dealer.

Proxy setting

- Go to **Network > Proxy**.

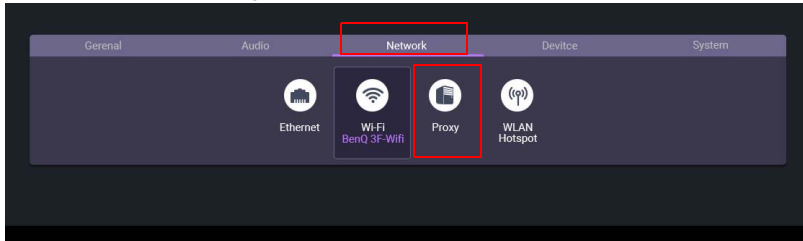

- Check the box of **Proxy Switch** to enable or disable the function.
- Enter the proxy host name.

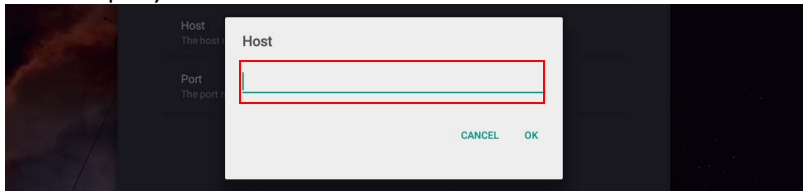

- Enter the using channel.

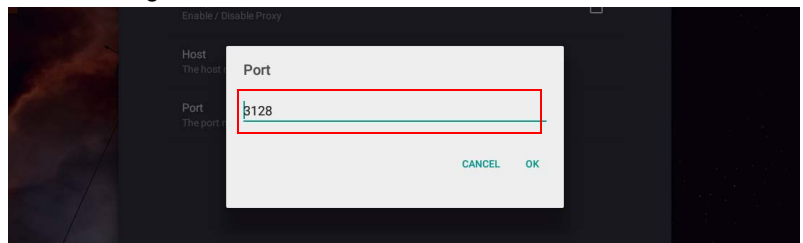

Menu operations

Control Action

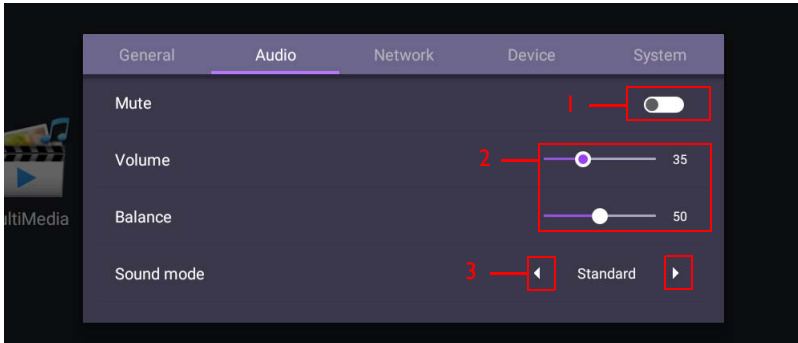

Action	Description
1	Press OK on the remote control to set on or off.
2	Press ◀ / ▶ on the remote control to adjust.
3	Press OK on the remote control to shift.

Press **BACK** on the remote control to exit the menu.

Setting menu

Input settings (Android)

Press **MENU** on the remote control or **MENU** on the front panel to enter the **General** menu. Select **Android**.

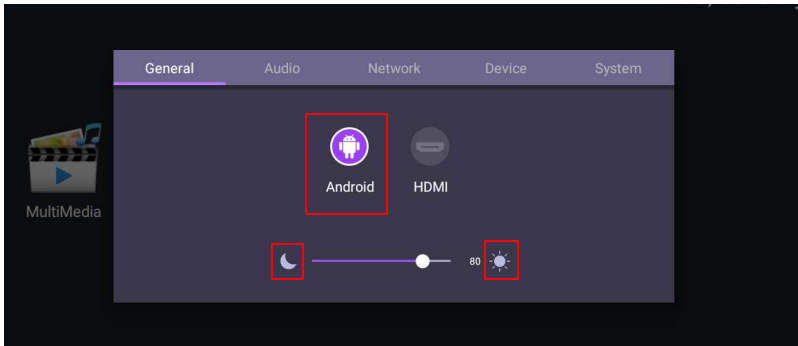

- Press **◀ / ▶** on the remote control and press **OK** to select a desired input source.
- Use the brightness bar to adjust the brightness for the display. Press **OK** on the sun/ moon icon to adjust max./ min. brightness.

Audio settings (Android)

Go to **Audio** to enter the **Audio** menu.

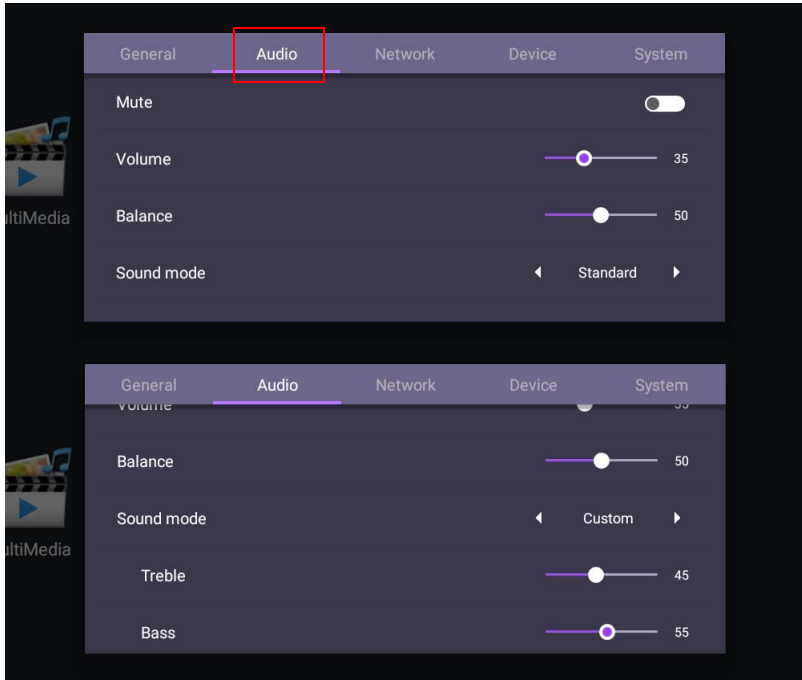

Menu	Description
Volume	Press ◀ / ▶ on the remote control to adjust the volume.
Balance	Press ◀ / ▶ on the remote control to adjust the balance.
Sound mode	Select a preset sound mode. Options are Standard , Class , Meeting , Movie , or Custom .  The default value of Sound mode is Standard . The detail settings of Sound mode can be modified only in Custom mode.
Treble	Press ◀ / ▶ on the remote control to adjust the treble.
Bass	Press ◀ / ▶ on the remote control to adjust the bass.



- The default value of **Mute** is **Off**. When mute is **On**, **Sound mode** and **Balance** are grayed out. Adjust the volume to switch **Mute** to **Off**.
- **Treble** and **Bass** are only displayed in **Custom** mode.

Device settings (Android)

Go to **Device** to enter the **Device** menu.

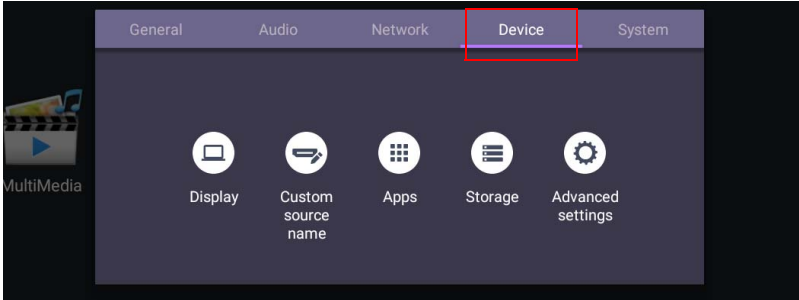

Display

Go to **Device > Display**.

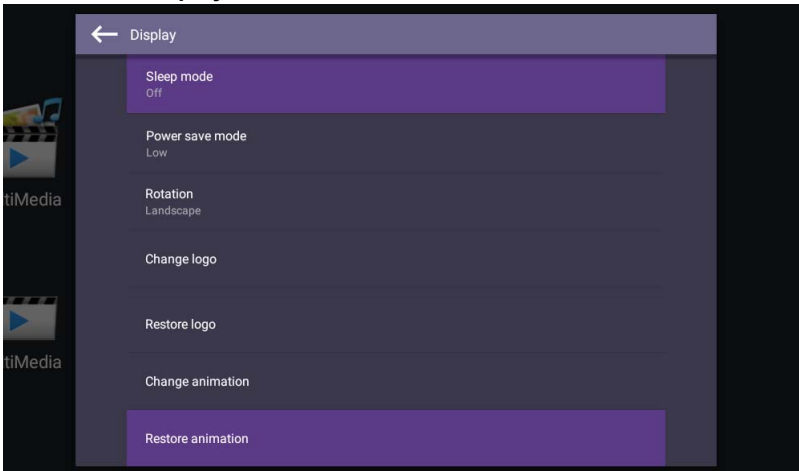

Menu	Description
Sleep mode	This feature only works on Android input. <ul style="list-style-type: none"> • Select a time period (1, 5, 10, 20, 30, 40, 50 minutes) for the display to turn off the panel back light. • Set to Off to turn off the function.
Power save mode	This feature only works on HDMI input. <ul style="list-style-type: none"> • High: Power off the display five minutes later. • Low: Turn off the panel back light five minutes later. • Off: Turn off the function.
Rotation	Switch the landscape and portrait mode.

Change logo	<ul style="list-style-type: none"> • Copy the boot logo file (JPG format, *.jpg, with resolution supports the display) to USB drive under “benq” folder. Rename the image to “logo.jpg”. • Click Change logo to load the changed logo.
Restore logo	Click Restore logo to restore the original logo.
Change animation	<ul style="list-style-type: none"> • Copy animation zip file (<2MB) to USB drive under “benq” folder. Rename the file to “bootanimation.zip”. • Click Change animation to load the changed animation.
Restore animation	Click Restore animation to restore the original animation.

Custom source name

You can change Custom source name. Enter a value within six characters long.

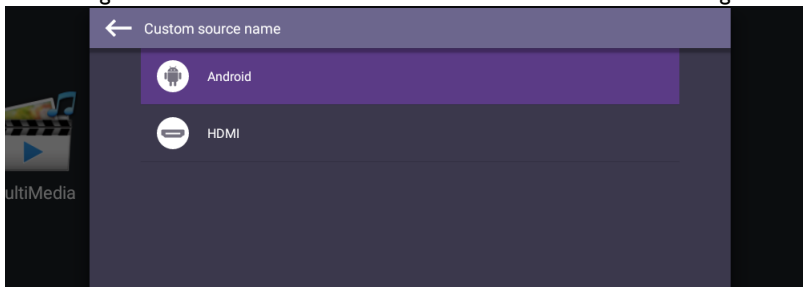

Advanced settings

Go to **Device > Advanced settings**.

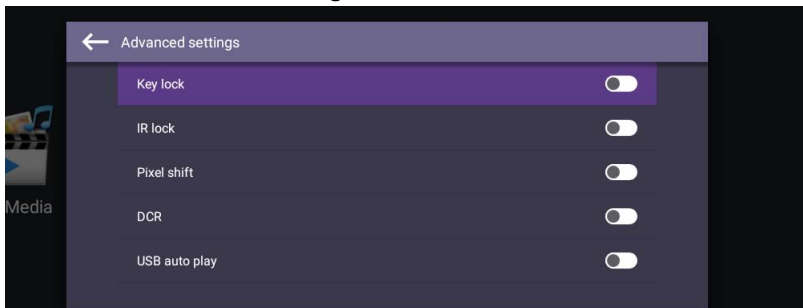

Menu	Description
Key lock	Press OK on the remote control to enable or disable Key lock .
IR lock	Press OK on the remote control to enable or disable IR lock .
Pixel shift	Press OK on the remote control to set a pixel shift preventing from image retention.
DCR	Press OK on the remote control to enable or disable DCR .
USB auto play	Press OK on the remote control to enable or disable USB auto play .



- The **Key lock** and **IR lock** functions cannot be enabled at the same time.
- For image retention, please see [Notes on the LCD panel of this display on page 7](#) for more information.

System settings (Android)

Go to **System** to enter the **System** menu.

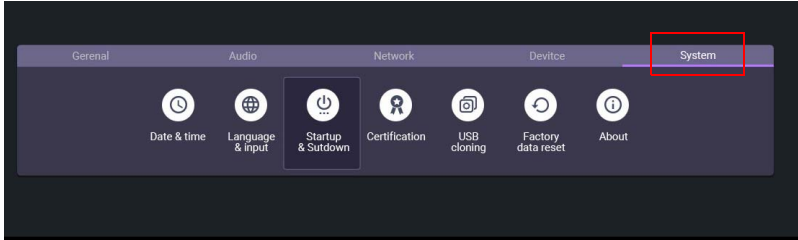

Options	Description
Date & time	Click to set date, time, and their formats in Android.
Language & input	Click to set Language and Input in Android.
Startup & Shutdown	Click to set Startup channel , Wake on Lan , Power off reminder , and Add task . Refer to Startup & Shutdown on page 38 for more information.
Certification	Click to check the acquired certification.
USB cloning	Click to export/import the setting.
Factory data reset	Select Factory data reset to erase all data from the display.
About	Click to view software version and get System Update . Refer to About on page 37 for more information.



The amount of available storage space for the user varies according to the amount of pre-installed apps and images occupying the total storage space.

About

Go to **About > System update**, then you will see update information.

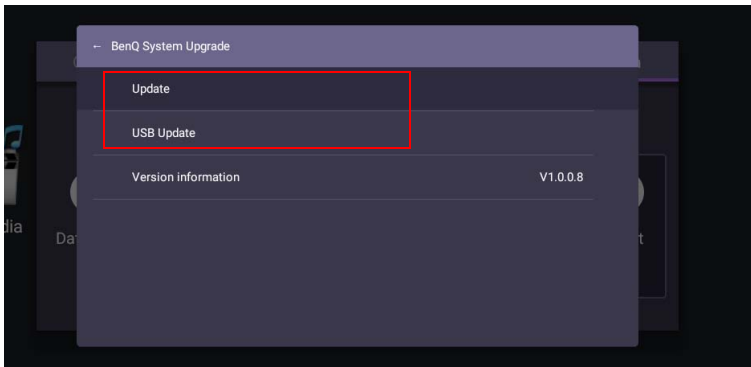
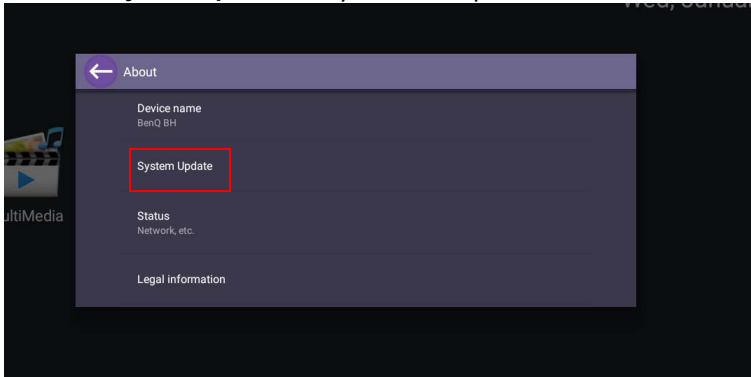

1. **Update:**
 - The device will search for the update file while connecting to the Internet.
 - If the auto update message does not show up, select **Update** to initiate manually.
2. **USB Update:**
 - Copy the upgrade file to the root of a FAT32 format USB drive. Make sure the file name is "update_signed.zip".
 - Insert the USB to the display, and the system will prompt a message for update confirm. If the message does not show up, select **USB Update** to start update detection.
 - Select **Start Update** to initiate upgrade process.

Startup & Shutdown

Go to **System > Startup & Shutdown**.

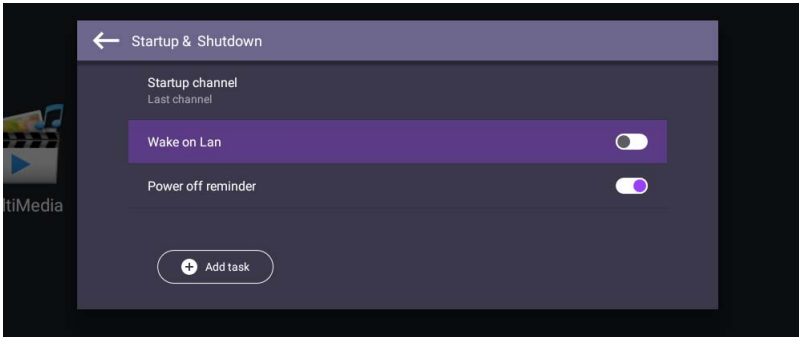
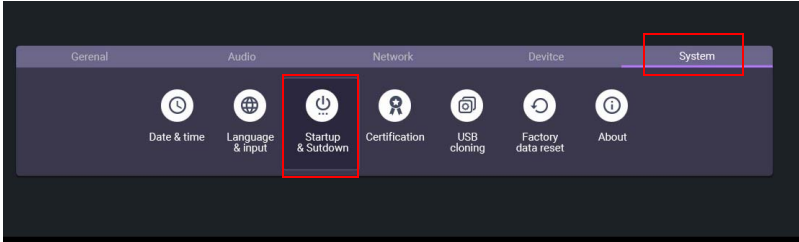

Options	Description
Startup channel	Select a startup input after powering on the display.
Wake on Lan	This feature allows computer to wake up display via LAN connection.
Power off reminder	Choose whether to display an alert message while powering off the display.
Add task	Setup a schedule to startup and shutdown the display periodically.

Schedules can be made by choosing the days of the week.

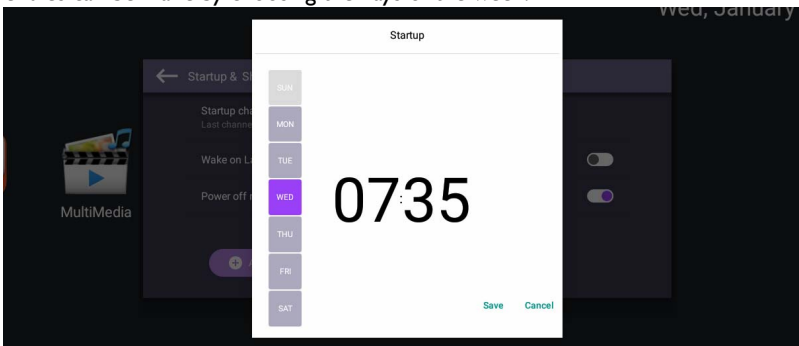

Input settings (HDMI)

- Press **MENU** on the remote control or **MENU** on the front panel to enter the **General** menu. Select **HDMI**. You can also switch to **HDMI** by directly connecting the HDMI cable to the device.

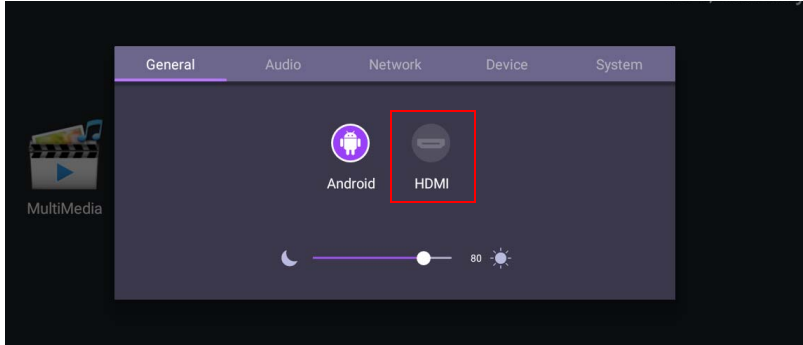



- For more information about Audio settings (HDMI), please refer to [Audio settings \(Android\)](#) on page 33.

For more information about Device settings (HDMI), please refer to [System settings \(Android\)](#) on page 36.

Display settings (HDMI)

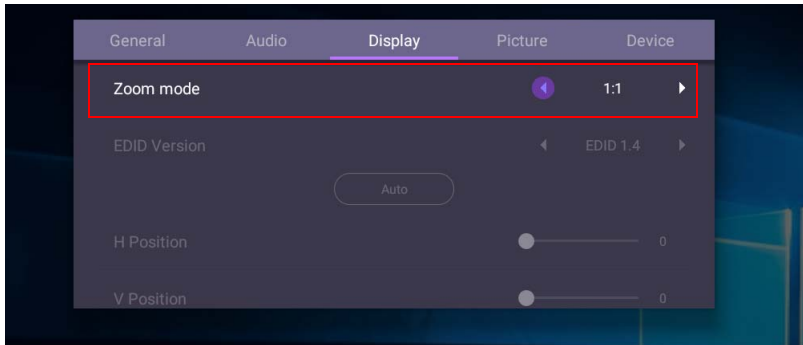
Use **Zoom mode** to adjust the image.



Menu	Description
Zoom mode	Options are Full / 1:1 .  The default value of Zoom mode is Full .

Picture settings (HDMI)

Leave the android system and connect to HDMI. Select **Picture**.

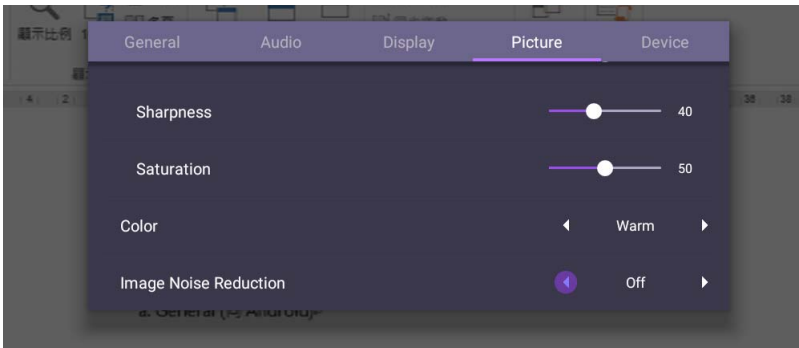
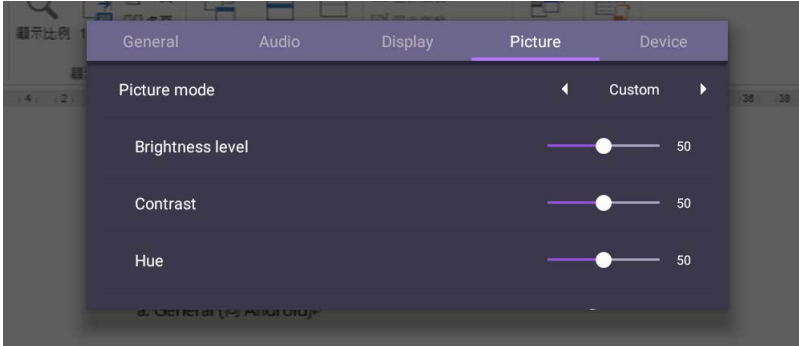

Menu	Description
Picture Mode	Options are Standard, Bright, Soft, and Custom . You can also adjust Brightness level, Contrast, Hue, Sharpness, and Saturation .  The default value of Picture Mode is Standard . The detail settings of Picture Mode can be modified only in Custom mode.
Color	Options are Standard, Cold, or Warm .
Image Noise Reduction	Options are Off, Low, Middle, High .

Product information

Specifications

Item		Specifications	
		BH2801/BH2801N	BH3801/BH3801D/ BH3801N
LCD panel	Backlight	E-LED	E-LED
	Panel size	28"	38"
	Active Area (horizontal × vertical)(mm)	BH2801: 699.4 x 133.0 BH2801N: 700.4 x 134.0	BH3801: 920.3 x 289.2 BH3801D: 920.3 x 288.0 BH3801N: 921.3 x 290.2 *New spec for 2020/Q4 or later shipment: 924.5 x 288.0
	Native resolution (pixels)	1920 x 360	1920 x 600 *New spec for 2020/Q4 or later shipment: 1920 x 614
	Brightness (cd/m ²) (typical)	1000 nits	BH3801/BH3801N: 1000 nits BH3801D: 700 nits
	Contrast (typical)	3000:1	BH3801/BH3801N: 3000:1 BH3801D: 1000:1 *New spec for 2020/Q4 or later shipment: 3000:1
	Aspect Ratio	16:3	16:5
	Panel Bit	8 bits	
Input	Computer	RJ45 x1	
	Video	HDMI 1.3 x1	
	Audio	NO	
	USB	Type-A x 2	
	Control	RS-232 IN (D-Sub 9-pin)	
Output	Computer/Video/Audio/Control	NO	
Audio	Audio W (Amp)	1W x 2	
	Internal speaker	O	
Power	AC power supply	100 - 240V AC, 50/60 Hz	
	Consumption (typical)	20W	BH3801/BH3801N: 38W BH3801D: 45W
	Consumption (standby)	≤0.5W	
Environment	Operating Temperature	0°C - 50°C	
	Operating Humidity	20% - 80% RH Non-Condensing	
	Storage Temperature	-25°C - 60°C	
	Storage Humidity	20% - 80% RH Non-Condensing	
	Display Orientation	Landscape/Portrait	

Mechanical	Weight (without packing / with packing)	BH2801: 5.3 kg/8.1kg BH2801N: 4.3kg/7.1kg	BH3801: 11.0kg/14.4kg BH3801D: 13.0kg/16.5kg BH3801N: 8.5kg/11.9kg *New spec for 2020/Q4 or later shipment: BH3801: 10.8kg/15.2kg BH3801D: 14.6kg/20.5kg BH3801N: 8.4kg/12.8kg
	Dimensions (W x H x D) (mm)	BH2801: 728.8 x 162.4 x 45.5 BH2801N: 725.8 x 159.4 x 43	BH3801: 949.6 x 317.6 x 45.6 BH3801D: 965.0 x 332.0 x 80.0 BH3801N: 946.6 x 314.6 x 43
	Bezel Dimension - T/B/L/R (mm)	BH2801: 14.7/4.7/14.7/ 14.7 BH2801N: 12.7/12.7/12.7/ 12.7	BH3801/BH3801D: 14.2/14.2/ 14.7/14.7 BH3801N: 12.2/12.2/12.6/ 12.6 *New spec for 2020/Q4 or later shipment: BH3801: 14.2/14.2/12.0/12.0 BH3801D: 21.5/21.5/19.3/19.3 BH3801N: 11.3/11.3/9.1/9.1

Item		Specifications	
		BH2401	BH3501
LCD panel	Backlight	E-LED	E-LED
	Panel size	24"	35"
	Active Area (horizontal × vertical)(mm)	598.6 x 59.0	886.6 x 59.0
	Native resolution (pixels)	1920 x 190	1920 x 130
	Brightness (cd/m ²) (typical)	1000 nits	
	Contrast (typical)	3000:1	
	Aspect Ratio	16:1.6	16:1
	Panel Bit	8 bits	
Input	Computer	RJ45 x1	
	Video	HDMI 1.3 x1	
	Audio	NO	
	USB	Type-A x 2	
	Control	RS-232 IN (D-Sub 9-pin)	
Output	Computer/Video/Audio/Control	NO	
Audio	Audio W (Amp)	1W x 2	
	Internal speaker	O	
Power	AC power supply	100 - 240V AC, 50/60 Hz	
	Consumption (typical)	13W	18W
	Consumption (standby)	≤0.5W	

Environment	Operating Temperature	0°C - 50°C	
	Operating Humidity	20% - 80% RH Non-Condensing	
	Storage Temperature	-25°C - 60°C	
	Storage Humidity	20% - 80% RH Non-Condensing	
	Display Orientation	Landscape/Portrait	
Mechanical	Weight (without packing / with packing)	3.4kg/5.5kg	3.9kg/6.4kg
	Dimensions (W x H x D) (mm)	629.6x90.0x45.5	905.0x89.2x45.3
	Bezel Dimension - T/B/L/R (mm)	15.5/15.5/15.5/15.5	15.1/15.1/9.2/9.2



Specifications and functions are subject to change without notice.

Item		BH2401/BH2801/BH3501/BH3801/BH3801D/BH2801N/ BH3801N
System	System Memory	2GB
	Storage	32GB
	OS	Android 6.0

X-Sign content compatibility

Model	BH2401	BH2801/ BH2801N	BH3501	BH3801/ BH3801N/ BH3801D	BH3801/ BH3801N/ BH3801D (2020/Q4 or later)
Video (avi/mkv/mp4)					
Landscape Resolution	1920 x 190	1920 x 360	1920 x 130	1920 x 600	1920 x 614
Portrait Resolution	190 x 1920	360 x 1920	130 x 1920	600 x 1920	614 x 1920
Video Format	H.265 (HEVC)	H.265 (HEVC)	H.265 (HEVC)	H.265 (HEVC)	H.265 (HEVC)
Picture					
JPG/PNG	JPG/PNG	JPG/PNG	JPG/PNG	JPG/PNG	JPG/PNG

USB device compatibility

USB Video Formats

File Extensions	Container	Video Codec	Maximum Resolution	Max. Frame Rate (fps)	Max. Bit Rate (Mbps)	Audio Codec
.dat .mpg .mpeg	MPG	MPEG1	1080P	30	20	MPEG-1 (L2 & L3) AC3 AAC L-PCM
.dat .mpg .mpeg	MPEG	MPEG2	1080P	30	20	MPEG-1 (L2 & L3) AC3 AAC L-PCM
.ts .trp .tp .m2ts	TS	MPEG2	1080P	30	20	MPEG-1 (L2 & L3) AC3 AAC
		H.264				
.vob	MPEG2-PS	MPEG2	1080P	30	20	MPEG-1 (L2 & L3) AC3 L-PCM
.mp4	MP4	MPEG4	1080P	30	20	MPEG-1 (L2 & L3) AAC
		H.264				

File Extensions	Container	Video Codec	Maximum Resolution	Max. Frame Rate (fps)	Max. Bit Rate (Mbps)	Audio Codec
.mkv	MKV	H.264	1080P	30	20	MPEG-I (L2 & L3) AC3 AAC L-PCM
		MPEG1				
		MPEG2				
		MPEG4				
.avi	AVI	MPEG2	1080P	30	20	MPEG-I (L2 & L3) AC3 AAC L-PCM
		MPEG4				
		H.264				
Motion JPEG	AVI, MOV	JPEG	640x480	30	10	
.asf	ASF	H.264	1080P	30	20	MPEG-I (L2 & L3) AC3 WMA L-PCM
		MPEG2				
		MPEG4				
		VCI				
		WMV3				
.wmv	ASF	MPEG4	1080P	30	20	WMA

USB Audio Formats

File Extensions	Audio Codec	Bit Rate (Kbps)	Sample Rate (Khz)
.mp3	MPEG1 Layer2	32 - 448	32 - 48
.mp3	MPEG1 Layer3	32 - 320	32 - 48
N/A (Works with video files only)	AC3	32 - 640	32, 44.1, 48
.m4a .AAC	AAC, HEAAC	24 - 384	8 - 48
.wma .asf	WMA	128 - 320	8 - 48
N/A (Works with video files only)	LPCM	64 - 1.5	8 - 48

USB Photo Formats

File Extensions	Image	Photo	Resolution
.jpg	JPEG	Base-line	15360x8640
		Progressive	1024x768
.png	PNG	non-interlace	4096x2160
		interlace	1200x800
.bmp	BMP		4096x2160

USB Video Internal Subtitle Formats (for subtitles, etc.)

File Extensions	Container	Subtitle Codec
.dat .mpg .mpeg .vob	MPG	DVD Subtitle
	MPEG	
.ts .trp .tp	TS	DVB Subtitle
.mp4	mp.4	DVB Subtitle
		UTF-8 Plain Text
.mkv	.mkv	DVD Subtitle
		UTF-8 Plain Text
		ASS
		SSA
		Universal Subtitle Format
	VobSub	
.avi	AVI	XSUB

USB Video External Subtitle Formats (for subtitles, etc.)

File Extensions	Container	Notes
.srt	SubRip	
.ssa	SubStation Alpha	
.ass	SAMI	
.smi		
.sub	SubViewer	SubViewer 1.0 & 2.0 only
	MicroDVD	
	DVDSubtitleSystem	
	SubIdx (VobSub)	
.txt	TMPlayer	

Dimensions

BH2801

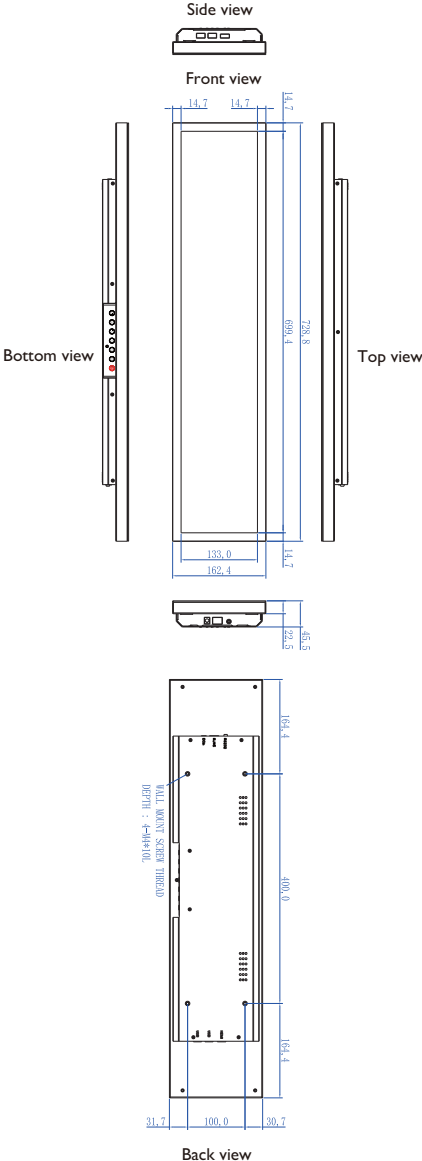

BH380I (1920x600)

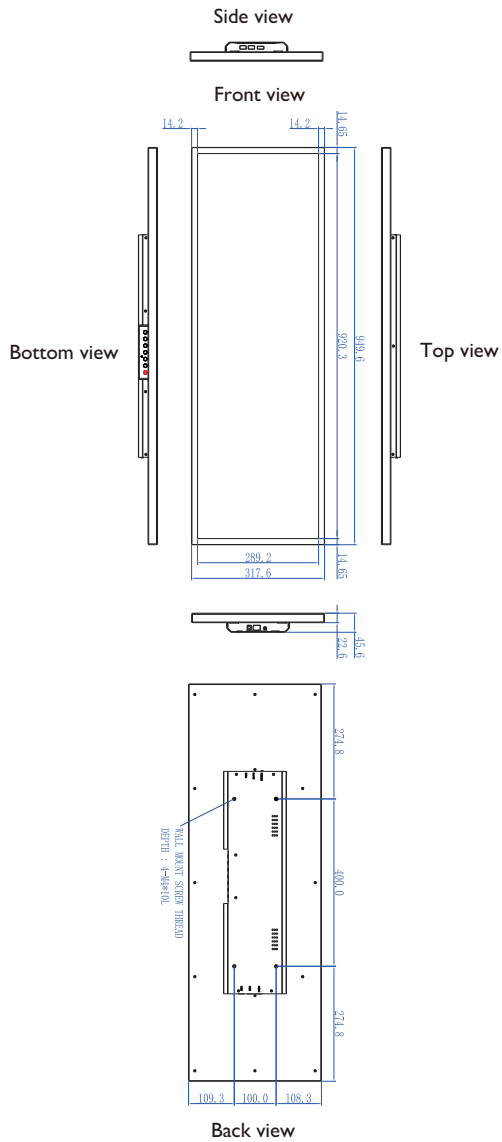

Unit: mm

BH2401

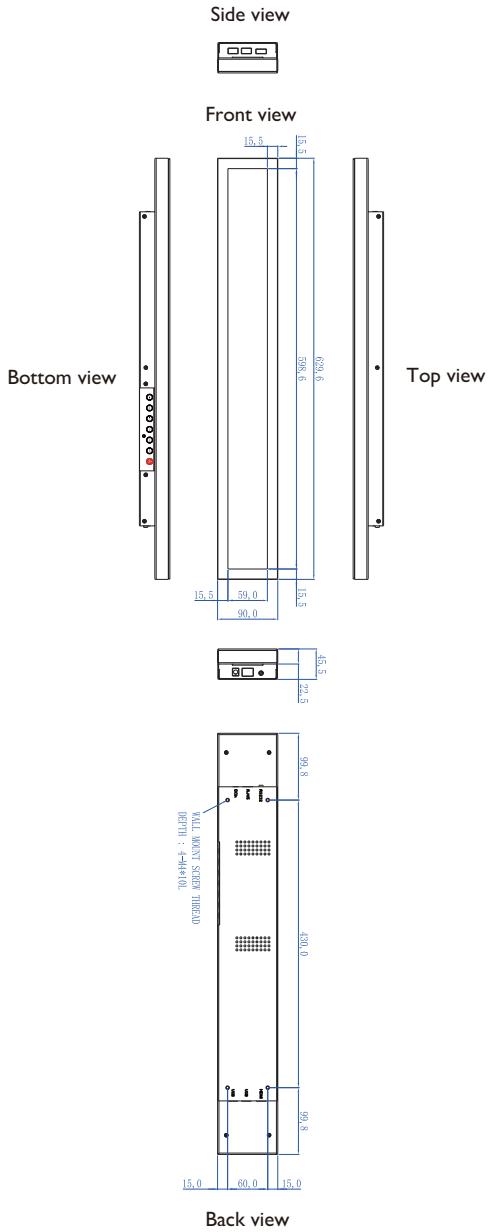

Unit: mm

BH3501

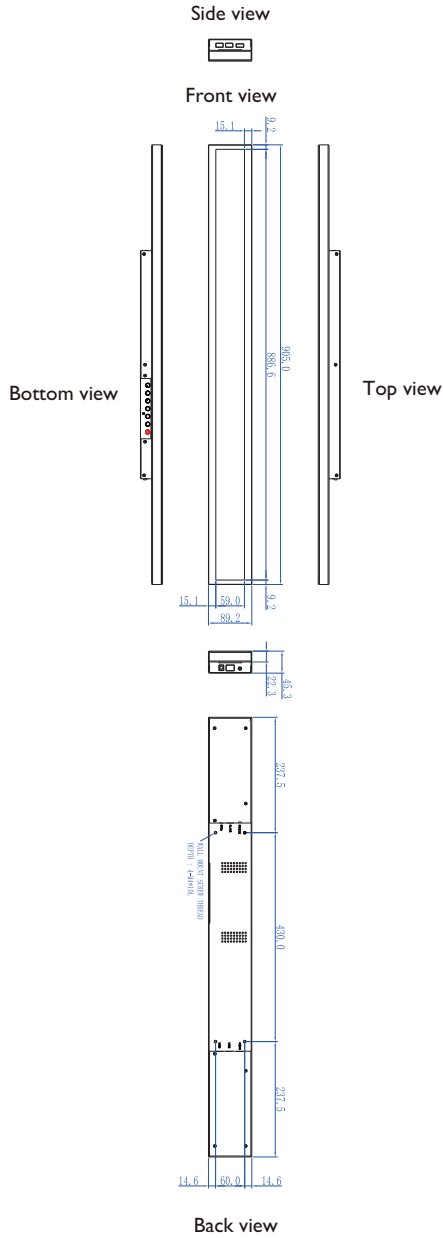

Unit: mm

BH3801D (1920x600)

Side view

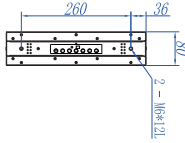

Front/ Back view

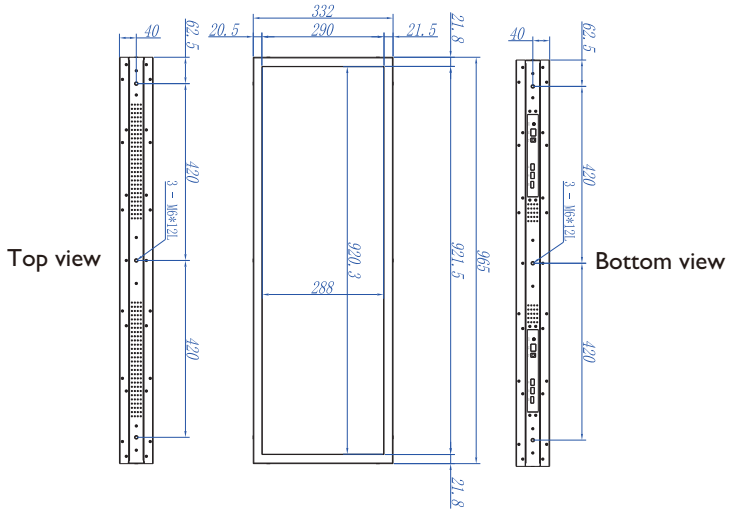

Side view

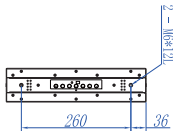

BH3801D (1920x614) *2020/Q4 or later

Side view

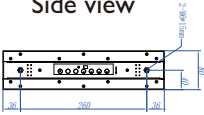

Front/ Back view

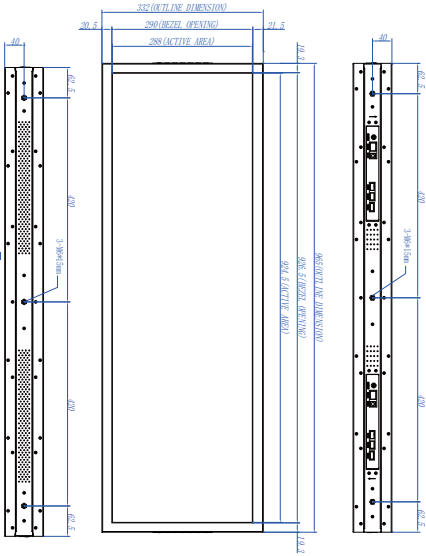

Top view

Bottom view

Side view

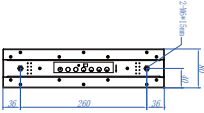

BH2801N

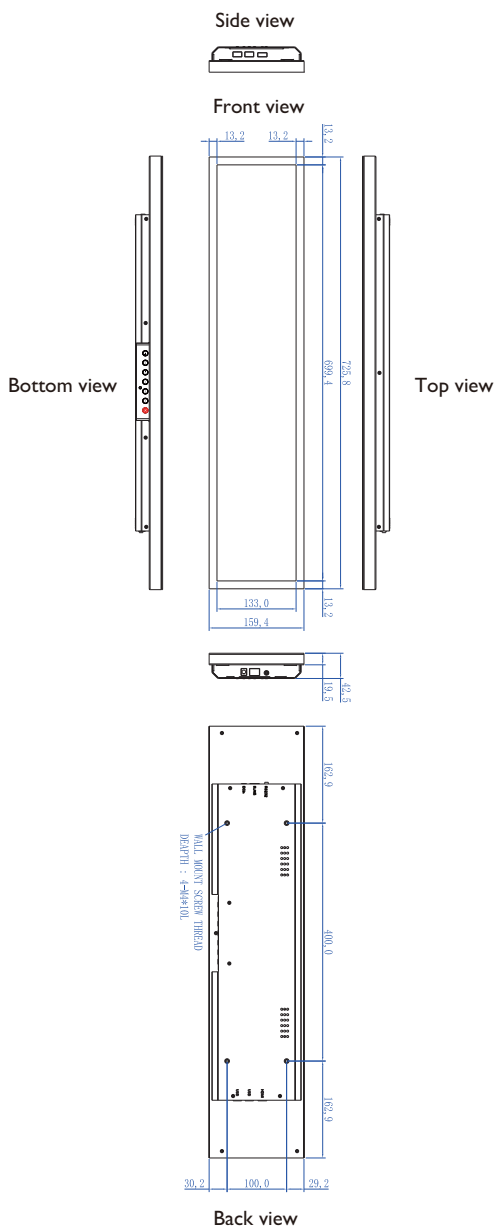

Unit: mm

BH3801N (1920x600)

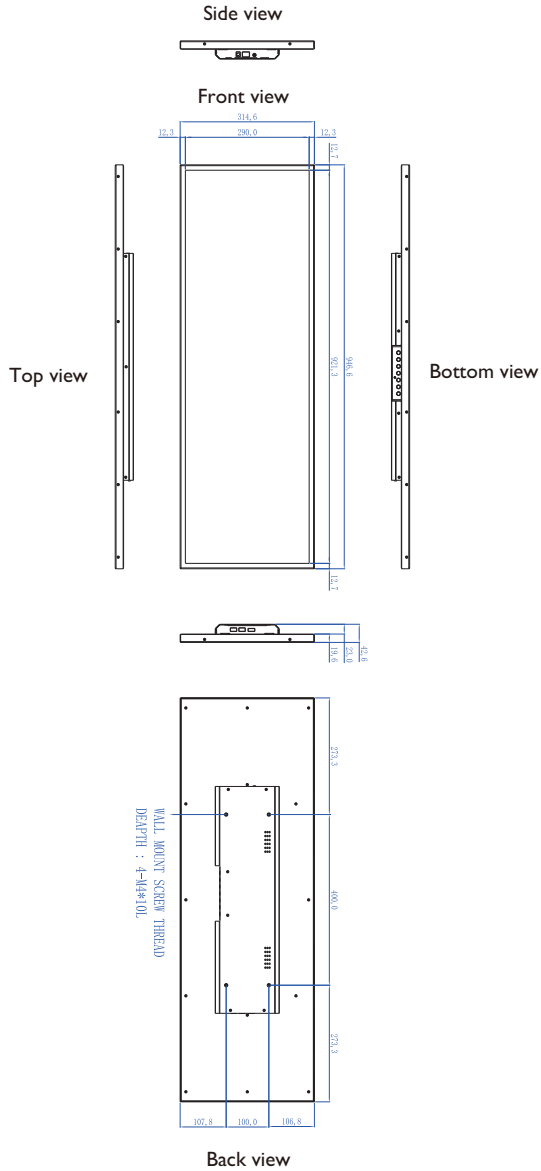

Unit: mm

BH3801N (1920x614) *2020/Q4 or later

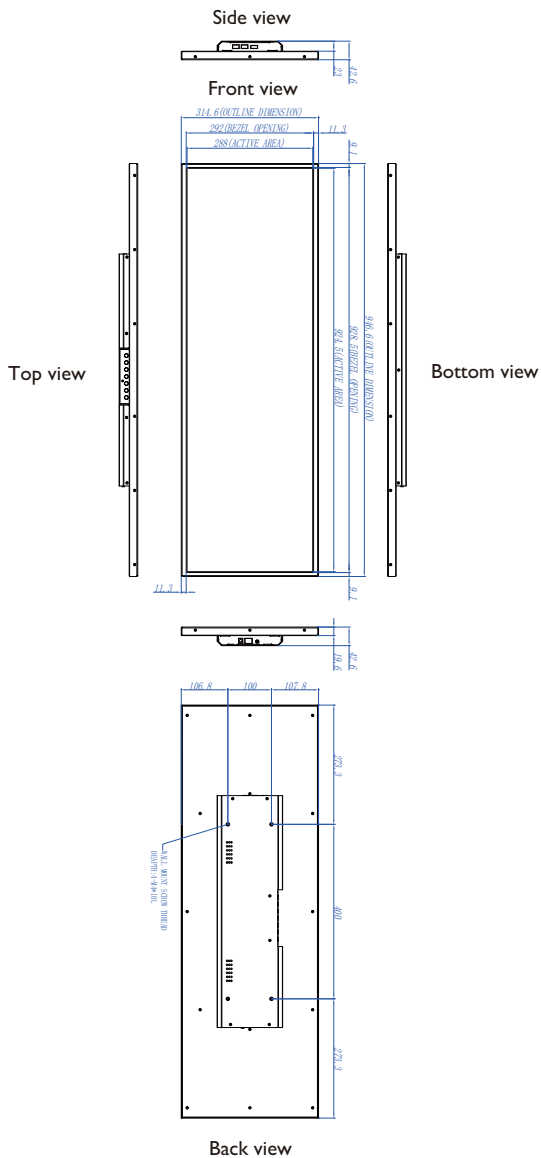

Supported input signal resolution

Resolution	Input source
	HDMI
1920 x 360 @ 60Hz	○
1920 x 600 @60Hz	○
1920 x 614 @60Hz	○
1920 x 1080 @ 60Hz	○
720p (50Hz)	○
720p (60Hz)	○
1080i (50Hz)	○
1080i (60Hz)	○
1080p (24Hz)	○
1080p (25Hz)	○
1080p (30Hz)	○
1080p (50Hz)	○
1080p (60Hz)	○



- : supported
- Vacant: not supported

Troubleshooting

Problem	Solution
No picture	<p>Check the following:</p> <ul style="list-style-type: none"> • Is the display turned on? Check the power indicator of the display. • Is the signal source device turned on? Turn on the device and try again. • Are there any loose cable connections? Make sure that all cables are connected firmly. • Have you chosen an unsupported output resolution on the computer? Refer to Supported input signal resolution on page 57 to select a supported resolution and try again. • Have you chosen an unsupported output resolution on the DVD or Blu-ray disc player? Refer to Supported input signal resolution on page 57 to select a supported resolution and try again.
No sound	<p>Check the following:</p> <ul style="list-style-type: none"> • Have you turned on the mute function on the display or the input source device? Turn off the mute function or increase the audio volume level and try again. • Are there any loose cable connections? Make sure that all cables are connected firmly.
The computer input image looks strange	<p>Have you chosen an unsupported output resolution on the computer? Refer to Supported input signal resolution on page 57 to select a supported resolution and try again.</p>
The control panel buttons do not work	<p>Have you locked the control panel buttons? Unlock the buttons and try again.</p>
The remote control does not work	<ul style="list-style-type: none"> • Have you locked the remote control function? Unlock the function and try again. • Check for incorrect battery orientation. • Check for dead batteries. • Check your distance and angle from the display. • Check whether remote control is properly being pointed at the display's remote control sensor window. • Check for any obstacle between the remote control and the remote control sensor window. • Check that the remote control sensor window is not under strong fluorescent lighting, or in direct sunlight. • Check for any devices (computer or personal digital assistant, PDA) nearby that transmit infrared signals which may cause interference to signal transmission between the remote control and the display. Turn off the infrared function of these devices.