



Digital Projector

# User Manual

Portable Series | GV30

V 1.00

# Product support

This document aims to provide the most updated and accurate information to customers, and thus all contents may be modified from time to time without prior notice. Please visit the website for the latest version of this document and other product information. Available files vary by model.

1. Make sure your computer is connected to the Internet.
2. Visit the local website from [Support.BenQ.com](https://Support.BenQ.com). The website layout and content may vary by region/country.

Search for your model's user manual and related document.

## Servicing

- If misuse or other accident occurs, contact qualified service personnel for servicing.
- Contact your place of purchase or visit the local website from [Support.BenQ.com](https://Support.BenQ.com) for more support.



Support.BenQ.com

# Q&A Index

Start with the topics you are interested in:

## Setup

### **How do I set up the projector and turn it on?**

Choosing a location	27
Operations	28

## Calibration and Image Editing

### **How do I adjust the focus of the projected image?**

Adjusting the projection angle	37
Fine-tuning the image clarity	38
Correcting keystone	39

### **How do I adjust the projector for outdoor use?**

Using the projector in an outdoor setting	27
Outdoor use	61

## Usage

### **How do I play music via the projector?**

Using the built-in speaker on the projector	43
Using the projector as a Bluetooth speaker	50

### **How do I use voice control?**

Google Assistant	42
------------------	----

### **Can I charge my device via the projector's USB-C port?**

Charging the battery	31
----------------------	----

## Maintenance and Product Support

### What should I do if I don't plan to use the projector for a long time?

Storing the projector

60

### How do I clean my projector after outdoor use?

Outdoor use

61

Important safety instructions

9

## Table of contents

Product support .....	2
Servicing.....	2
Q&A Index .....	3
Package contents .....	12
Standard accessories.....	12
Introduction .....	14
Projector exterior view .....	14
Front, top, and left side view .....	14
Rear, bottom, and right side view.....	15
Dimensions.....	16
Ports .....	17
LED indicators .....	18
Remote control.....	21
Installing/Replacing the remote control batteries .....	23
Remote control effective range.....	24
<b>BenQ Smart Control</b> (remote control app) .....	25
Installation .....	27
Choosing a location .....	27
Using the projector in an outdoor setting.....	27
Operations .....	28

Installing the ATV dongle.....	28
Charging the battery .....	31
Starting up the projector .....	32
Shutting down the projector .....	36
Adjusting the projected image .....	37
Adjusting the projection angle .....	37
Fine-tuning the image clarity.....	38
Correcting keystone.....	39
<b>Android TV</b> .....	<b>40</b>
The <b>Android TV</b> home screen.....	40
Google Assistant .....	42
Playing music via the projector .....	43
Using the built-in speaker on the projector .....	43
Using the projector as a Bluetooth speaker .....	43
<b>Connections</b> .....	<b>44</b>
Switching between <b>Android TV</b> and input sources .....	46
Wireless connections .....	47
Wireless projection.....	47
Wired connections.....	48
Connecting a device with HDMI or USB-C with DisplayPort.....	48
Connecting a flash drive .....	49
Bluetooth connections .....	50
Using the projector as a Bluetooth speaker .....	50
Pairing/Connecting to a Bluetooth speaker or headphones .....	51

Navigating the settings menu .....	53
About the settings menu .....	53
Using the <b>Settings</b> menu.....	54
<b>Brightness</b> .....	55
<b>Picture Mode</b> .....	55
<b>Sound Mode</b> .....	55
<b>Picture</b> .....	56
<b>Installation</b> .....	56
<b>Power Mode</b> .....	58
<b>Focus</b> .....	58
<b>System</b> .....	59
Maintenance .....	60
Care of the projector .....	60
Cleaning the lens.....	60
Storing the projector .....	60
Transporting the projector .....	61
Outdoor use .....	61
Extending LED life .....	61
Troubleshooting .....	62
Specifications .....	65
Projector specifications .....	65
Timing chart.....	68
Supported file formats.....	71
Appendix .....	72
Installing the projector on a tripod (purchased separately) .....	72
Copyright and disclaimer .....	73

Copyright .....	73
Disclaimer .....	73
Warranty .....	73
Statement regarding hyperlinks and third-party websites .....	74



# Important safety instructions

Your projector is designed and tested to meet the latest standards for safety of information technology equipment. However, to ensure safe use of this product, it is important that you follow the instructions mentioned in this manual and marked on the product.

1. Please read this user manual before you operate your projector.  
Keep this manual in a safe place for future reference.

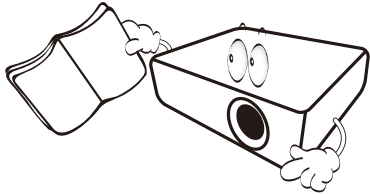

2. Always place the projector on a level, horizontal surface during operation.
  - Do not place the projector on an unstable cart, stand, or table as it may fall and be damaged.
  - Do not place inflammables near the projector.
  - Do not use if tilted at an angle of more than 10 degrees left to right, nor at angle of more than 15 degrees front to back.

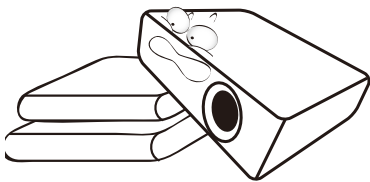

3. Do not store the projector on end vertically. Doing so may cause the projector to fall over, causing injury or resulting in damage.

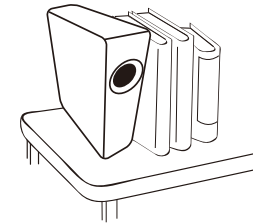

4. Do not place the projector in any of the following environments:
  - Space that is poorly ventilated or confined. Allow at least 50 cm clearance from walls and free flow of air around the projector.
  - Locations where temperatures may become excessively high, such as the inside of a car with all windows closed.
  - Locations where excessive humidity, dust, or cigarette smoke may contaminate optical components, shorten the projector's lifespan and darken the screen.

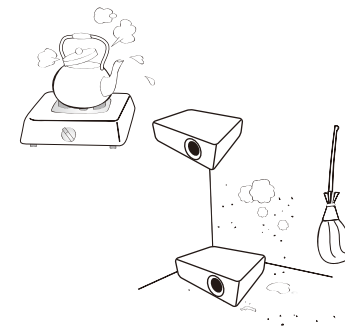

- Locations near fire alarms.
- Locations with an ambient temperature above 40°C/104°F.

- Locations where the altitudes are higher than 2000 m (6562 feet).

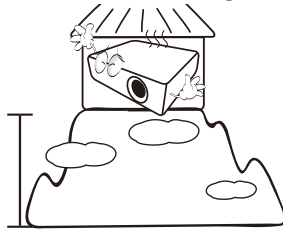

5. Do not block the vents holes while the projector is on (even in power-saving mode).
  - Do not cover the projector with any item.
  - Do not place the projector on a blanket, bedding or any other soft surface.

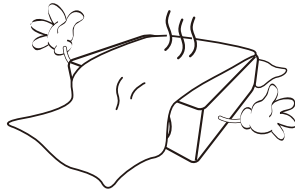

6. In areas where the mains power supply voltage may fluctuate by  $\pm 10$  volts, it is recommended that you connect the projector through a power stabilizer, surge protector or uninterruptible power supply (UPS) as appropriate to your situation.

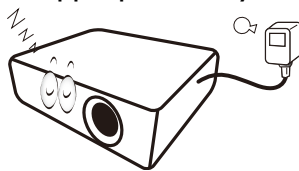

7. Do not step on the projector or place any objects upon it.

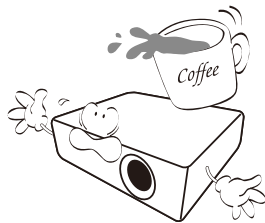

8. Do not place liquids near or on the projector. Liquids spilled into the projector will void your warranty. If the projector does become wet, disconnect it from the power point and call BenQ to have the projector repaired.

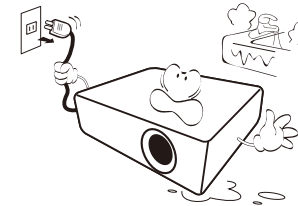

9. Do not look straight into the projector lens during operation. It may harm your sight.

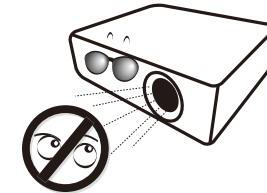

10. Do not operate the projector LED beyond the rated LED life. Excessive operation of LEDs beyond the rated life could cause LEDs to break on rare occasions.

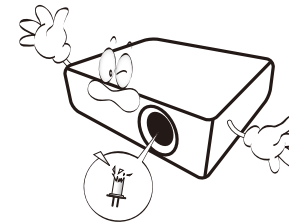

11. Do not attempt to disassemble this projector. There are dangerous high voltages inside which may cause death if you should come into contact with live parts.

Under no circumstances should you ever undo or remove any other covers. Refer servicing only to suitably qualified professional service personnel.

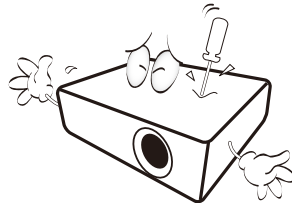

**!** Please keep the original packing for possible future shipment. If you need to pack your projector after use, adjust the projection lens to an appropriate position, put the lens cushion around the lens, and fit the lens cushion and projector cushion together to prevent damage during transportation.

12. When you think service or repair is required, take the projector only to a suitably qualified technician.

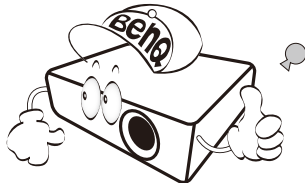

## Moisture condensation

Never operate the projector immediately after moving it from a cold location to a hot location. When the projector is exposed to such a change in temperature, moisture may condense on the crucial internal parts. To prevent the projector from possible damage, do not use the projector for at least 2 hours when there is a sudden change in temperature.

## Avoid volatile liquids

Do not use volatile liquids, such as insecticide or certain types of cleaner, near the projector. Do not have rubber or plastic products touching the projector for a long time. They will leave marks on the finish. If cleaning with a chemically treated cloth, be sure to follow the cleaning product's safety instructions.

## Disposal

This product contains the following materials which are harmful to human bodies and environment.

- Lead, which is contained in solder.

To dispose of the product, consult your local environment authorities for regulations.

**!** The illustrations and the images shown in this document are for your reference. The actual content may vary by the product supplied for your region.

# Package contents

Carefully unpack and verify that you have the items below. Some of the items may not be available depending on your region of purchase. Please check with your place of purchase.

## Standard accessories

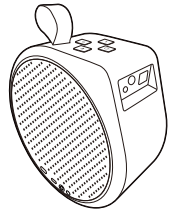

**GV30 Projector**



**ATV Dongle (QS01)**

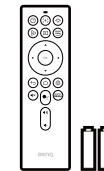

**Remote Control  
(with Two AAA Batteries)**

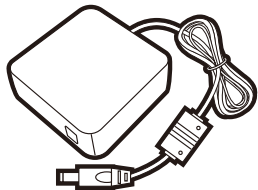

**Adapter**

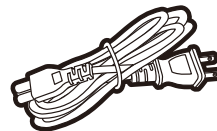

**Power Cord**

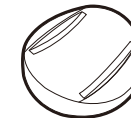

**Projector Base**



**Pick**

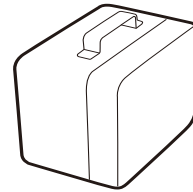

**Carrying Bag**

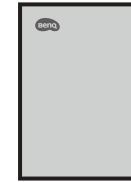

**Quick Start Guide**



**Warranty Card  
(varies by region)**



**Regulatory Statement**

- 
-  • LED life results will vary depending on environmental conditions and usage. Actual product's features and specifications are subject to change without notice.
- Some of the accessories may vary from region to region.
  - The warranty card is only supplied in some specific regions. Please consult your dealer for detailed information.
  - For AC/DC adapter, the socket-outlet shall be installed near the equipment and shall be easily accessible.
  - Use original accessories to ensure compatibility.
  - Power cord plug type may change based on regional requirements.
-

# Introduction

## Projector exterior view

### Front, top, and left side view

See [Connections on page 44](#) for connection details.

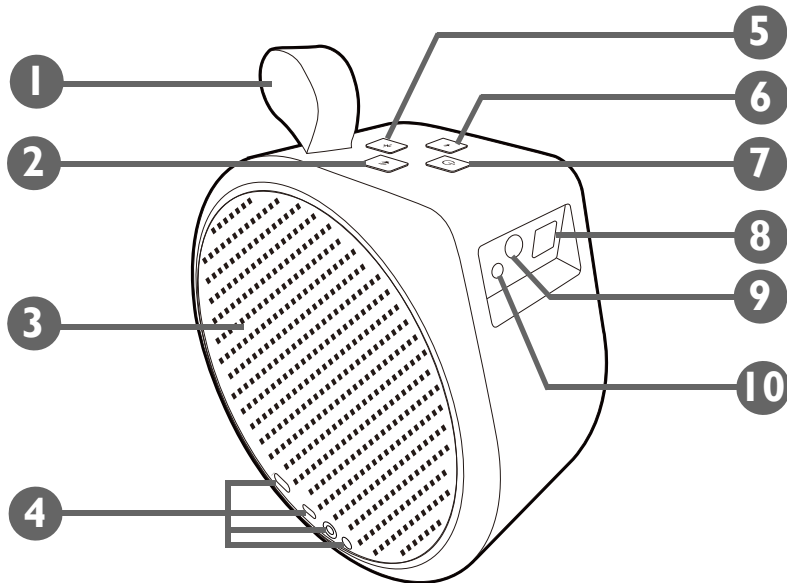

1. **Hand strap**

2. **Volume up button**

3. **Left speaker and vent**

4. **IO ports**

See [Ports on page 17](#) for details.

5. **Bluetooth button and LED**

Activates Bluetooth speaker mode. See [Using the projector as a Bluetooth speaker on page 50](#) for more details. See [LED indicators on page 18](#) for details on the LED behavior.

6. **Volume down button**

7. **Power button and LED**

Turns the projector on and off. See [Starting up the projector on page 32](#) for more details. See [LED indicators on page 18](#) for details on the LED behavior.

8. **Projection lens**

9. **IR sensor**

10. **Auto focus camera**

## Rear, bottom, and right side view

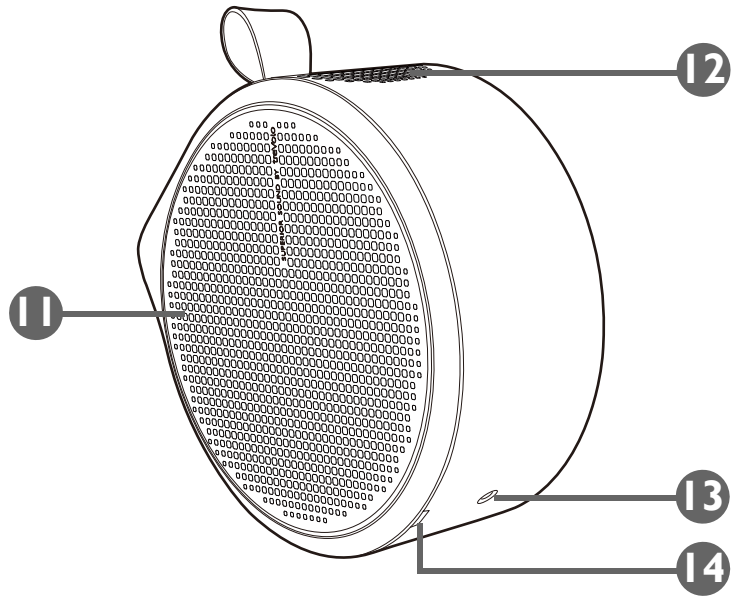

**11. Right speaker and vent**

**12. Top speaker**

**13. Tripod screwhole**

Used to attached a tripod plate to mount the projector on a tripod. See [Installing the projector on a tripod \(purchased separately\) on page 72](#) for details.

**14. Right cover recess**

Used to remove the right cover to install the ATV dongle (QS01). See [Installing the ATV dongle on page 28](#) for more details about removing the right cover.

## Dimensions

185.0 (W) x 185.0 (H) x 87.0 (D) mm (without base)

185.0 (W) x 195.8 (H) x 120.0 (D) mm (with base)

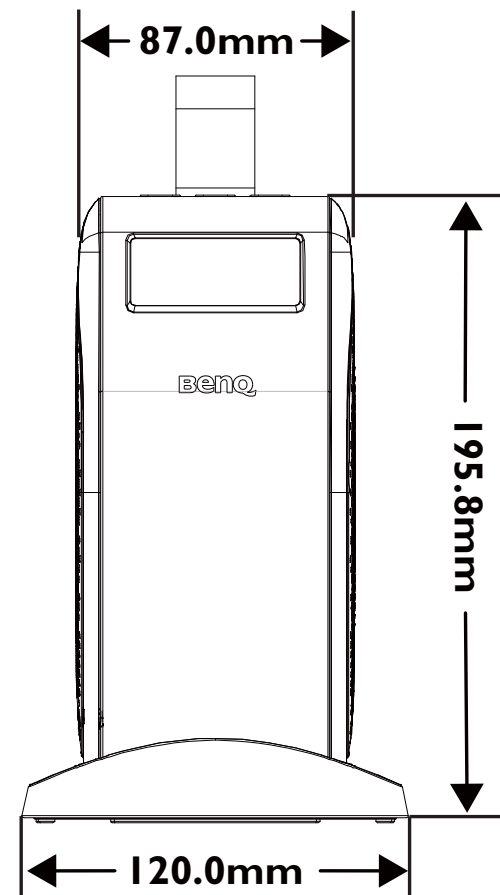
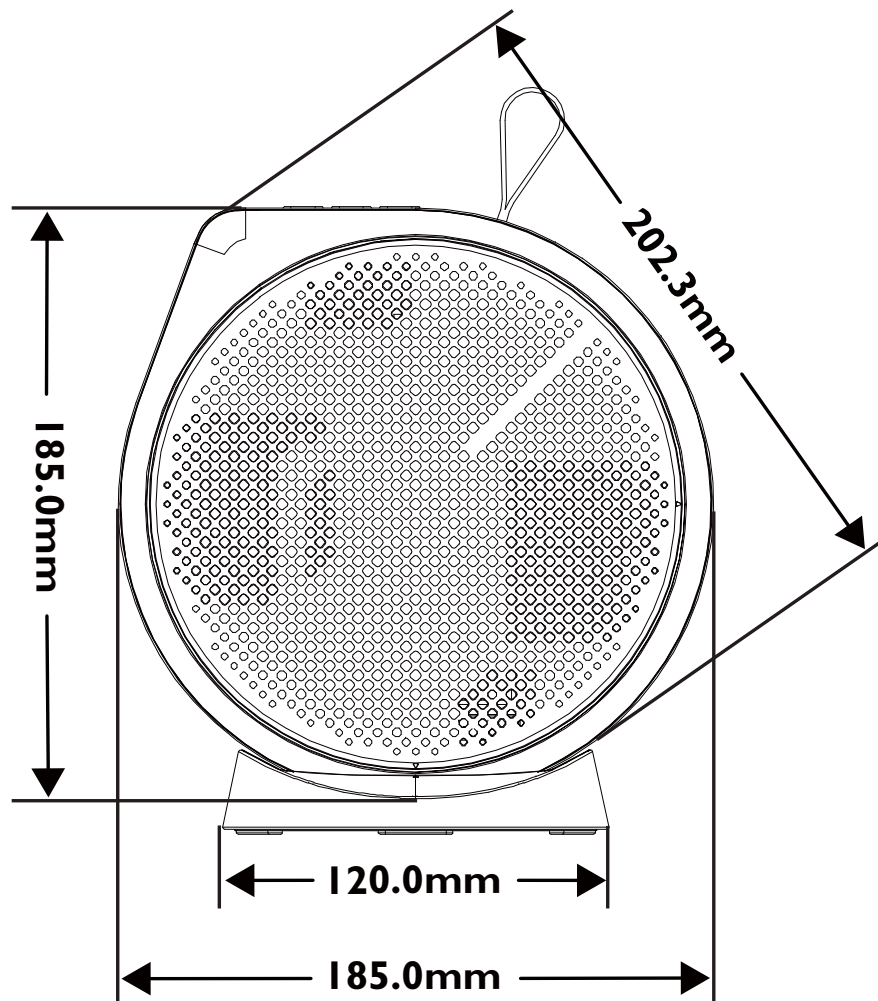



## Ports

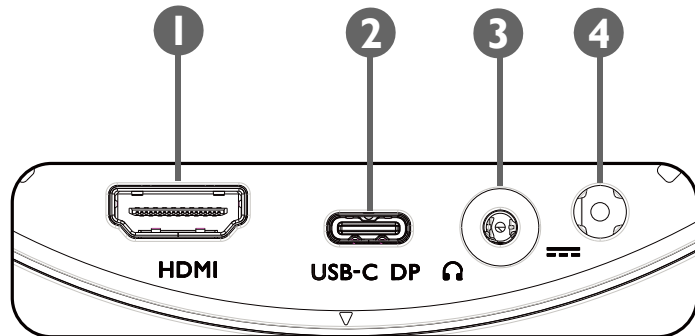

### 1. HDMI port (Version 1.4b)

Used to connect video sources that support the HDMI interface.

### 2. USB-C port with DisplayPort functionality

- Used to connect a USB-C storage device to project/broadcast media stored on the device.
- Used to connect devices with DisplayPort functionality to project video from the device.



The USB-C port is able to provide power (5V, 1.5A) to connected devices.

### 3. 3.5" audio output jack

Used to connect headphones, speakers, and other equipment to broadcast audio.

### 4. Power adapter port



Please only use the supplied power adapter to avoid possible dangers such as electric shock and fire.

## LED indicators

There is a multi-color power LED (1) and a blue/red Bluetooth LED (2) at the top of the projector.

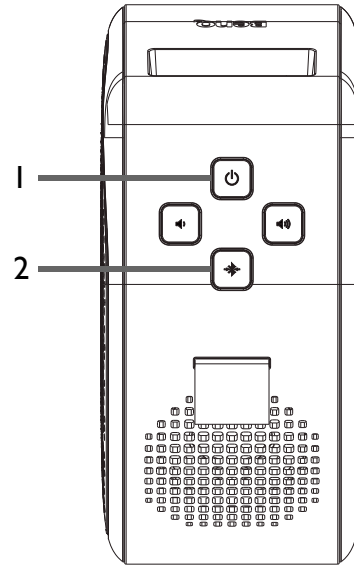

Refer to the table below for definitions of various LED behaviors.

Scenario	Status	Power LED indicator	Bluetooth LED indicator
		LED Behavior	LED Behavior
Turning on / Turning off	Powering on / off properly	Green - flashing	N/A
	Low battery capacity (< 5%)	Red - flashing until the power button on the device is no longer pressed	N/A
Charging with Adapter	Battery capacity = 0 - 94%	Red - solid	N/A
	Battery capacity = 95 - 100%	Green - solid	N/A

Scenario		Status	Power LED indicator	Bluetooth LED indicator
			LED Behavior	LED Behavior
Battery Mode	Power on	Battery capacity = 60 - 100%	Green - solid	N/A
		Battery capacity = 21 - 59%	Orange - solid	N/A
		Battery capacity $\leq$ 20%	Red - flashing	N/A
	Standby	Battery capacity = 60 - 100%	Green - breathing	N/A
		Battery capacity = 21 - 59%	Orange - breathing	N/A
		Battery capacity $\leq$ 20%	Red - breathing	N/A
Battery percentage check (by double-clicking the Power button)		Battery capacity = 60 - 100%	Green - flashing twice	N/A
		Battery capacity = 21 - 59%	Orange - flashing twice	N/A
		Battery capacity $\leq$ 20%	Red - flashing twice	N/A
Bluetooth Speaker Mode		Switching to Bluetooth speaker mode	Refer to charging or battery mode behavior.	Blue - flashing
		Waiting for pairing and connecting	Refer to charging or battery mode behavior.	Blue - flashing
		Connected successfully	Refer to charging or battery mode behavior.	Blue - flashing twice then solid
		Playing music	Refer to charging or battery mode behavior.	Blue - solid
		Disconnecting and entering into Bluetooth standby mode	Refer to charging or battery mode behavior.	Blue - solid then flashing
		Switching to Projector mode	Refer to charging or battery mode behavior.	Blue - flashing then off

Scenario	Status	Power LED indicator	Bluetooth LED indicator
		LED Behavior	LED Behavior
Error*	Driver board error	Purple - solid	Red- flashing
	Fan error	Red - solid	Red - flashing
	Optical engine temperature error	Red - flashing	Red - solid
	Battery error	Purple - flashing	Red - solid
	G sensor error	N/A	N/A

\*Restart the projector if there are any errors.

# Remote control

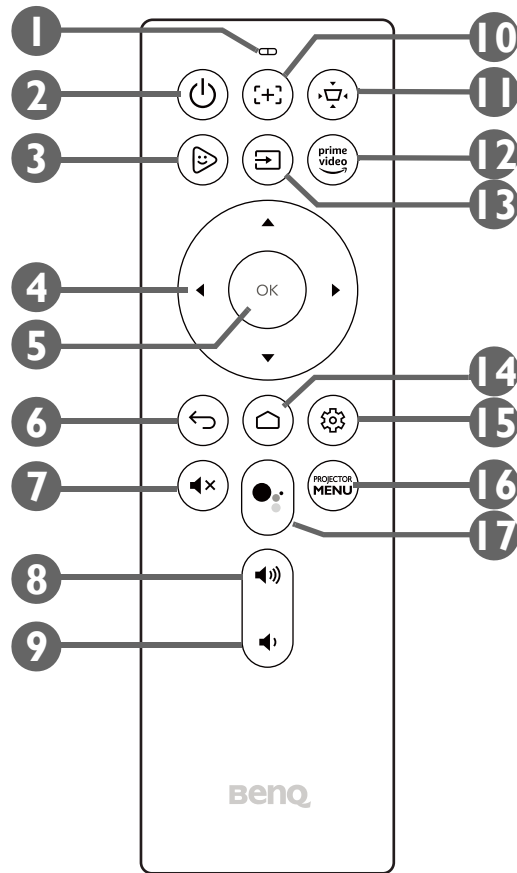

- 1. Microphone**  
Receives spoken commands for Google Assistant.
- 2. Power**  
Turns the projector off and on.
- 3. FamiLand**  
Launches the **FamiLand** app in **Android TV**.
- 4. Arrow buttons (◀Left, ▶Right, ▲Up, ▼Down)**  
Used as navigation buttons to select the desired menu items and to make adjustments.
- 5. OK**  
Used to confirm selections.
- 6. Back**  
Returns to the previous menu.
- 7. Mute**  
Mutes the projector's audio.
- 8. Volume Up**  
Increases the projector volume.
- 9. Volume Down**  
Decreases the projector volume.

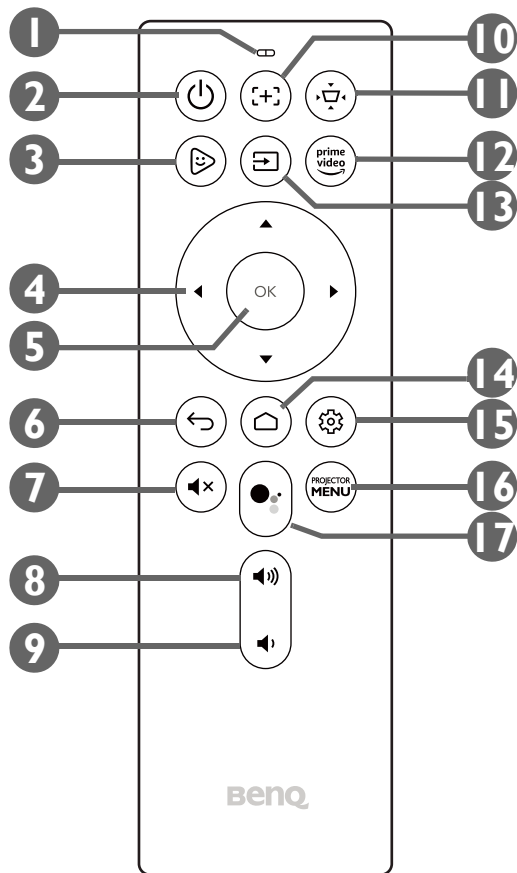

**10. [Focus]** Focus

Adjusts the focus for the projector automatically. See [Fine-tuning the image clarity on page 38](#) for more details.

**11. [Keystone]** Keystone

Adjusts the keystone for the projector. See [Correcting keystone on page 39](#) and [Installation on page 56](#) for more details.

**12. Prime Video**

Launches Amazon’s Prime Video streaming service.

**13. [Source]** Source

Opens the input source menu.

**14. [Home]** Home

Returns to the **Android TV** home menu.

**15. [Settings]** Settings

Launches the **Android TV** settings menu.

**16. PROJECTOR MENU**

Launches the projector’s on-screen settings menu.

**17. [Google Assistant]** Google Assistant

Activates Google Assistant, Google’s voice powered virtual assistant service. For more information on Google Assistant, including supported commands and phrases, check Google’s official website.

## Installing/Replacing the remote control batteries

Before you can begin to use the remote control, you must install the supplied batteries into the remote control.

1. Slide the battery cover outwards.

---

 When sliding the battery cover, do not try to pull the cover too hard as it is tethered to the remote control by a plastic band and cannot be completely removed.

---

2. Insert the batteries in the orientation shown below.
3. Slide the battery cover back onto the remote control.

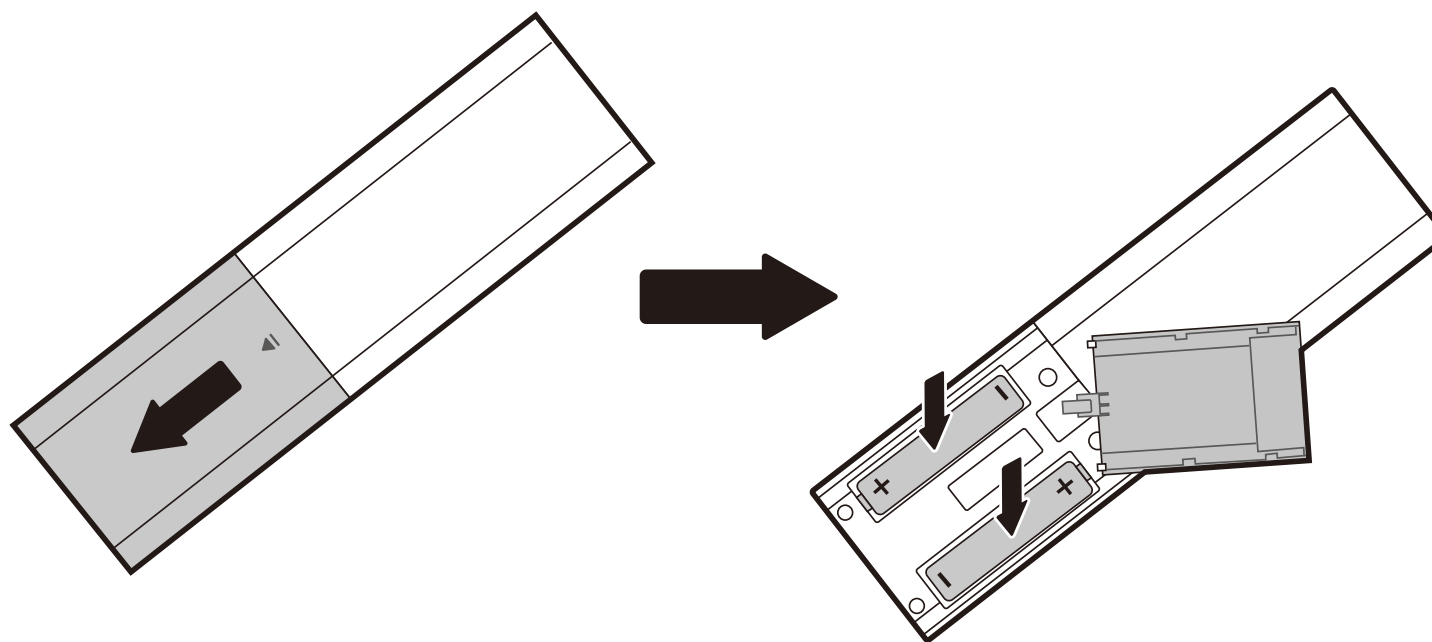

---

 Avoid leaving the remote control and battery in an excessively hot or humid environment like the kitchen, bathroom, sauna, sunroom or in a closed car.

---

## Remote control effective range

The projector has an IR remote control sensor located at the front of the projector with a range of 8 meters (~26 feet) at an angle of 30 degrees (left and right) and 20 degrees (up and down). Prior to remote control pairing process during the setup wizard (see for [Starting up the projector on page 32](#) details), the remote control can only be used either by pointing it directly at the IR sensor or by reflecting the IR signal off of a wall/screen, making sure that there are no obstacles between the remote control and the IR sensor on the projector.

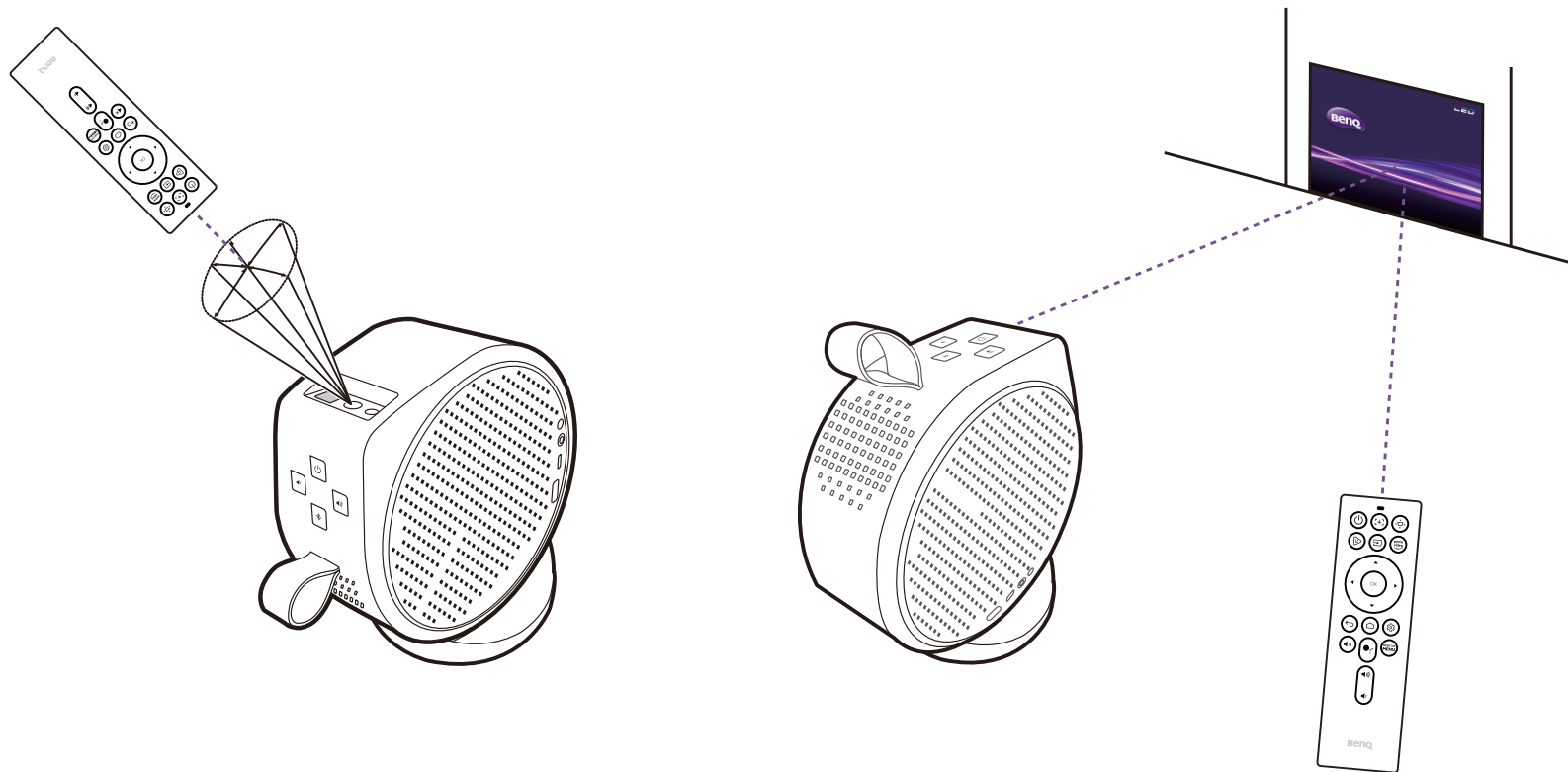

Once the remote control has been paired to the ATV dongle installed in the projector, you will be able to use it at any angle within a range of 7 meters (~23 feet).

---

 Voice input and Google Assistant functionality on the remote control is only available after the remote control has been paired to the projector during the setup wizard process. See [Starting up the projector on page 32](#) for more details.

---



## BenQ Smart Control (remote control app)

The projector also supports the **BenQ Smart Control** app, which lets you transform your Android or iOS device into a remote control to control the projector via buttons and/or touch gestures.

To begin using the **BenQ Smart Control** app:

1. Download and install **BenQ Smart Control** from Google Play or the iOS App Store on your device.
2. Connect your smartphone to the same wireless network as the ATV dongle (QS01).
3. Open the **BenQ Smart Control** app  on your smartphone.
4. The app will automatically connect to your ATV dongle (QS01).

- 
-  You must be connected to the same wireless network as the projector for **BenQ Smart Control** to work correctly.
  - If the app does not automatically connect to your ATV dongle (QS01), or if multiple compatible products are connected to the same network, select the corresponding ATV dongle (QS01) you want to control from the list of products.
- 

5. Choose one of the following methods to use **BenQ Smart Control**:
  - Tap **DPad** to use the pre-configured buttons in the app to control your projector.

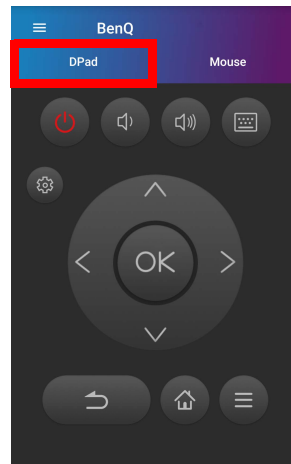

- Tap **Mouse** to use touch gestures on your smartphone to control the cursor on the projector similar to a mouse.

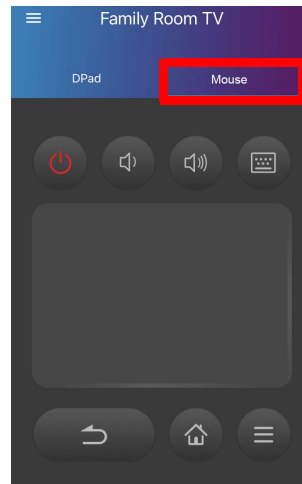

# Installation

## Choosing a location

Before choosing an installation location for your projector, take the following factors into consideration:

- Size and position of your screen
- Electrical outlet location
- Location and distance between the projector and the rest of your equipment
- Location and distance between the projector and the wireless access point

## Using the projector in an outdoor setting

The projector is designed mainly for indoor use but its portable design also allows it to support occasional outdoor use. When using the projector outdoors, the following items are suggested to enhance the viewing experience:

- Install the projector on a tripod if there is no flat surface to place the projector. See [Installing the projector on a tripod \(purchased separately\) on page 72](#) for more details.
- Set the picture mode to the most suitable setting (e.g. **Day Time** for a brightly lit environment). See [Picture Mode on page 55](#) for more details.

# Operations

## Installing the ATV dongle

1. Remove the cap from the provided ATV dongle.
2. Place the projector on a flat and stable surface covered by a protective sheet with its right cover facing up.
3. Using the pick, pry open the right cover from the recess at its bottom side and then slide the pick counterclockwise around the right cover to release the cover from the projector.

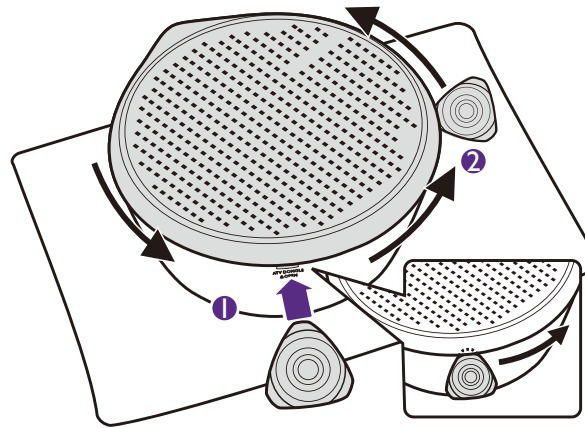

Ensure the tip of the pick is fully inserted into the recess to pry open the cover.

4. Remove the right cover from the projector.

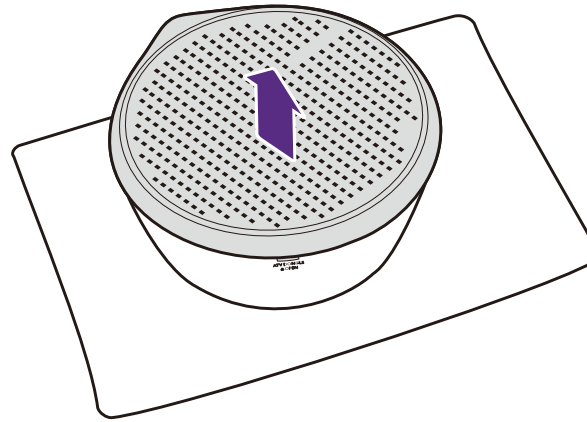

5. Connect the power cable to the port on the side of the dongle and then insert the dongle into the ATV dongle port so that the logo side is facing up.

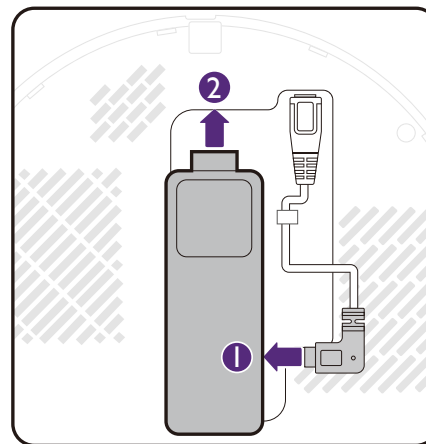

6. Re-install the right cover onto the projector.

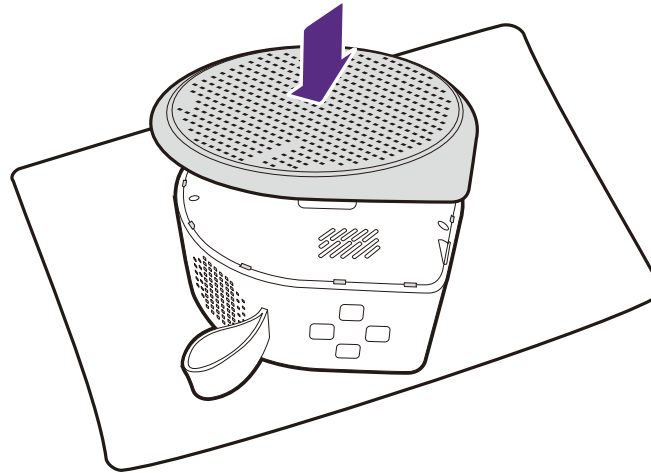

## Charging the battery

1. Connect the adapter to the power adapter port.
2. Connect the power cord to the power adapter.
3. Connect the power cord to a power outlet.

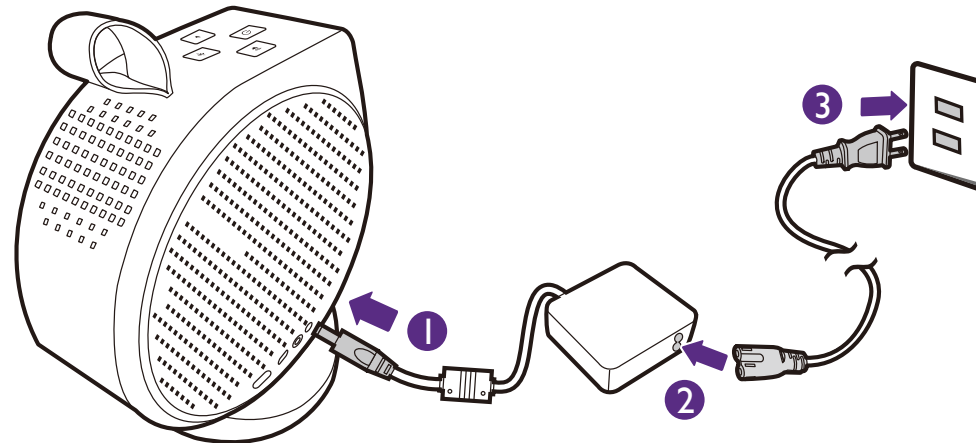

- The projector also supports charging via a power bank of USB Power Delivery capability with output power of at least 45W (15V, 3A).
- When charged, the projector is able to supply power via both its USB-C (5V, 1.5A) port.

The power LED indicator will illuminate according to its charge status, for a full charge wait until the indicator lights up solid green (see [LED indicators on page 18](#) for more information on LED behavior).

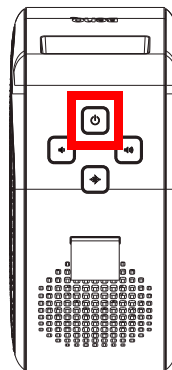

# Starting up the projector

**!** If you are starting up the projector for the first time, it is suggested that the projector is within range of a wireless access point (e.g. a router) with a stable Internet connection as some optional steps during the setup process require Internet access.

1. Install the provided ATV dongle into the ATV dongle port. See [Installing the ATV dongle on page 28](#) for details.
2. Charge the battery or supply power to the projector as indicated in [Charging the battery on page 31](#).
3. Press the power button  on the projector for 3 seconds or remote control for 1 second. The power LED will flash a breathing green pattern.

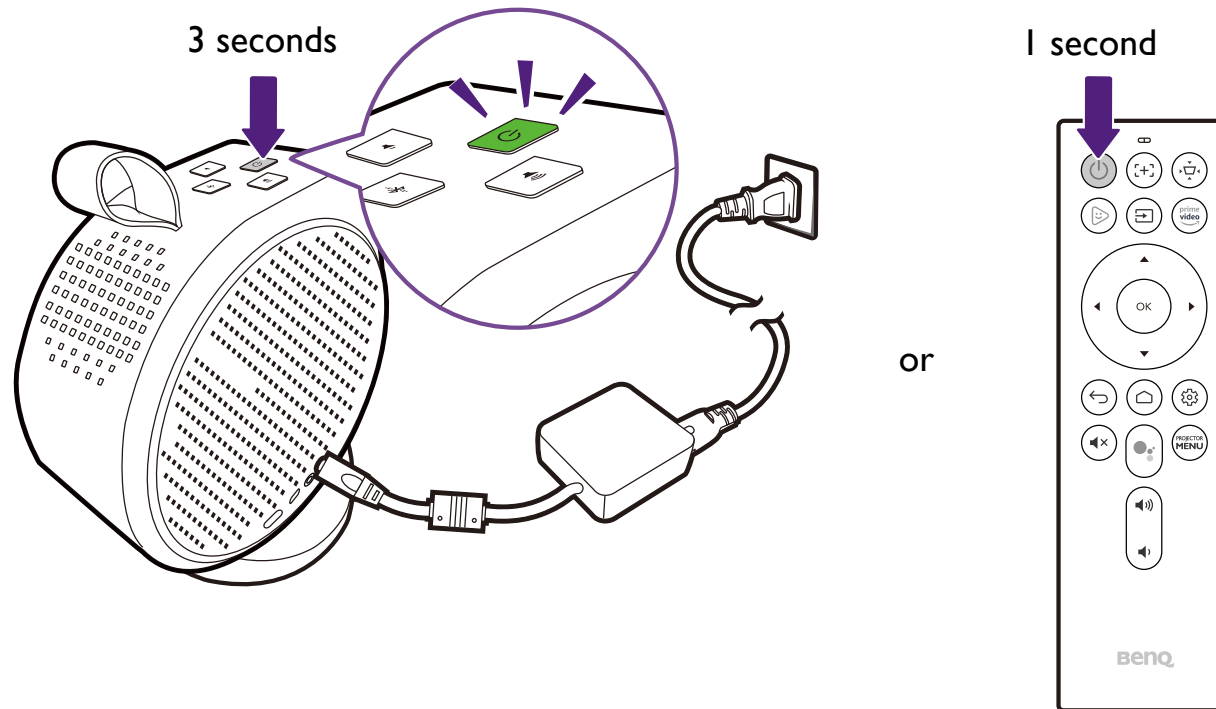

- !**
- When supplying power directly to the projector please use the supplied power cable to avoid possible dangers such as electric shock and fire.
  - Prior to pairing the remote control to your projector you must ensure that your remote control is in range of the projector's IR sensor. See [Remote control effective range on page 24](#) for more details.
  - Powering on via the remote control will not work if you have not completed the setup wizard procedure or if the projector's battery level is below 5%.



- The fans will start operating and a start-up image will be shown while the projector warms up. This process may take a few minutes. The projector does not respond to further commands while it is warming up.
- If you are starting up the projector for the first time, the projector's setup wizard will appear to guide you through the initial hardware setup including selecting the system language and correcting keystone. Using your remote control, follow the on-screen instructions to proceed with the process.

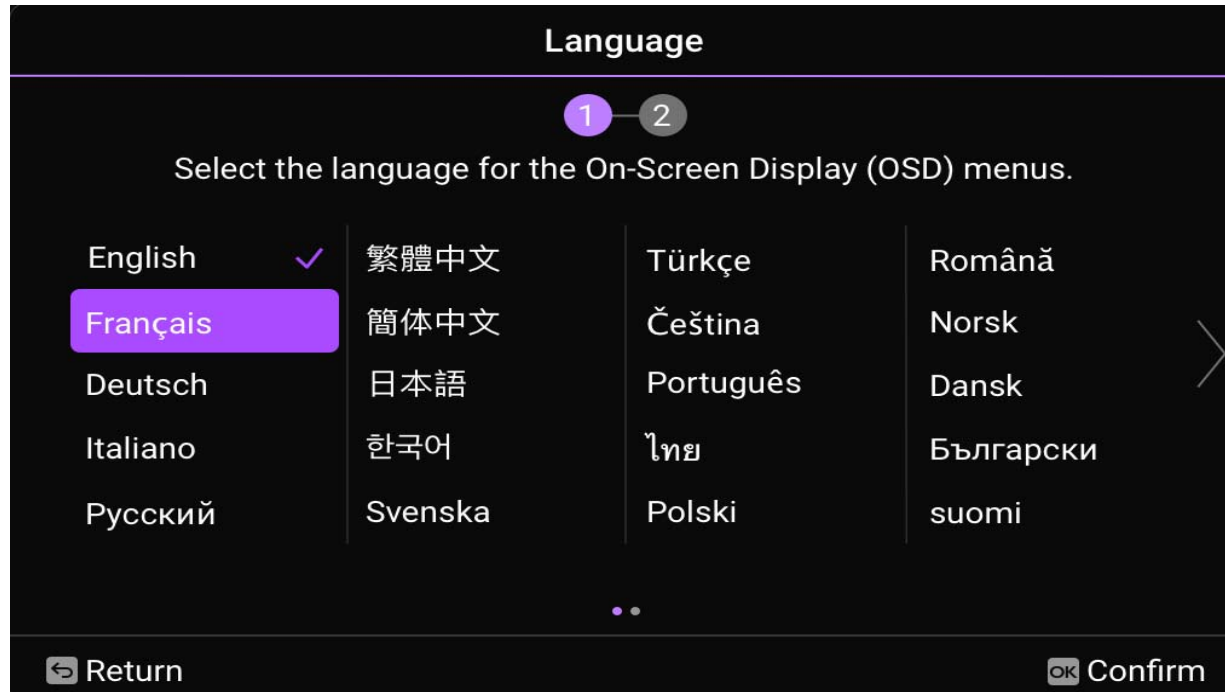

6. Once you've completed the projector's setup wizard, the projector will begin the **Android TV** setup wizard to guide you through setting up the projector's operating system, including steps for pairing the remote control, selecting the language for **Android TV**, setting up a Wi-Fi connection, signing in to a Google account, and other related steps.
- 



- Pairing your remote control to the projector and connecting to a network are required steps in order to proceed with the **Android TV** setup process. You will not be able to use your projector's **Android TV** operating system until you have completed both steps. You will still be able to project via a wired connection if you do not complete the **Android TV** setup process.
- You may proceed with the **Android TV** setup process without signing into a Google account, but you will have limited use of **Android TV**'s services and will be prompted to sign in any time you attempt to use these services.
- To find out how to quickly set up your Google account on the projector, scan one of the QR codes below based on your mobile device's operating system and watch the how-to video.

- **With iOS device**

<https://www.benq.com/en-us/knowledge-center/knowledge/how-to-start-benq-smart-home-projector.html#S1>



- **With Android device**

<https://www.benq.com/en-us/knowledge-center/knowledge/how-to-start-benq-smart-home-projector.html#S2>



7. Once you've completed the **Android TV** setup wizard, the **Android TV** home screen will appear.

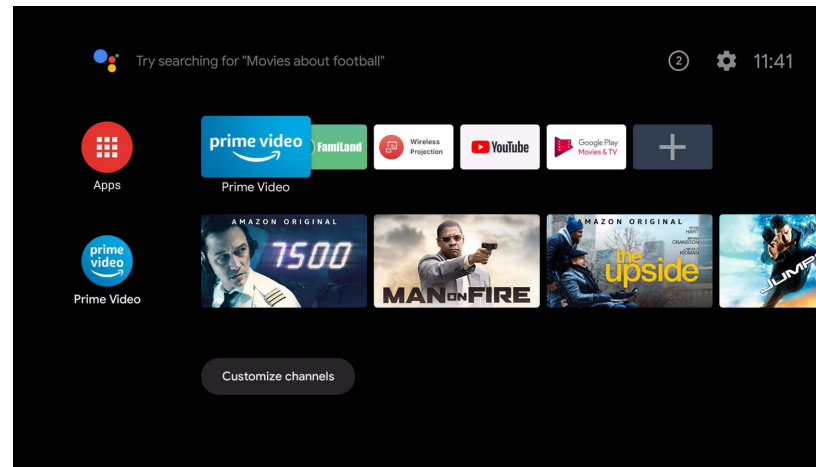

You may enjoy streaming services now. See [Android TV on page 40](#) for more information. Or you may connect a device to the projector to project video. See [Connections on page 44](#) for more information.



The screenshots above are for reference only and may differ from the actual design.

---

# Shutting down the projector

1. Press and hold the power button  on the projector or remote control for over 3 seconds and the projector will shut down directly.

 Short pressing the power button on the projector or remote control will trigger a shutdown confirmation box. Under this condition, press the power button again to shut down the projector.

2. The power LED will flash a breathing green pattern (see [LED indicators on page 18](#)). The fans may continue to run in order to cool the system.

If the projector will not be used for an extended period, unplug the power cable from the power outlet and remove the batteries from the remote control.

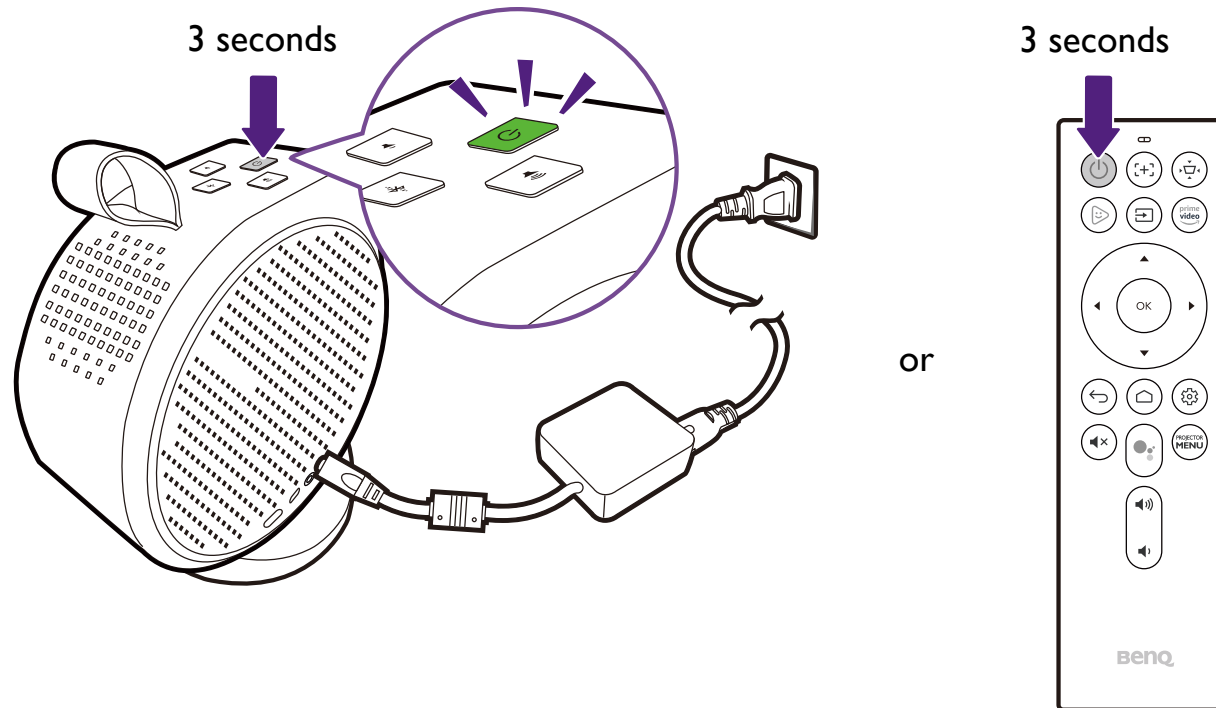

# Adjusting the projected image

## Adjusting the projection angle

The projector features a magnetic base that holds the projector and allows you to adjust the projection angle.

Place the projector properly on the base and rotate the projector to adjust the projection angle.

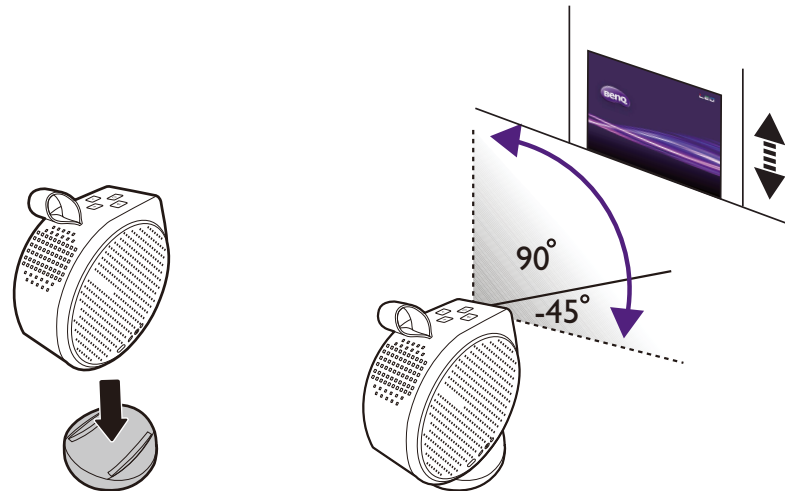

- The maximum angle of adjustment is 135 degrees.
- If the screen and the projector are not perpendicular to each other, the projected image becomes trapezoidal. To correct this, see [Correcting keystone on page 39](#) for details.

**!** When the projector is on, **DO NOT** place down the projector with its left or right vents facing down as this will block the vents.

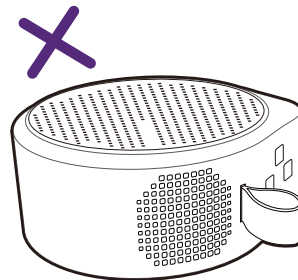

## Fine-tuning the image clarity

To sharpen the picture, press the focus button (F) on the remote control and the projector will automatically focus the image.

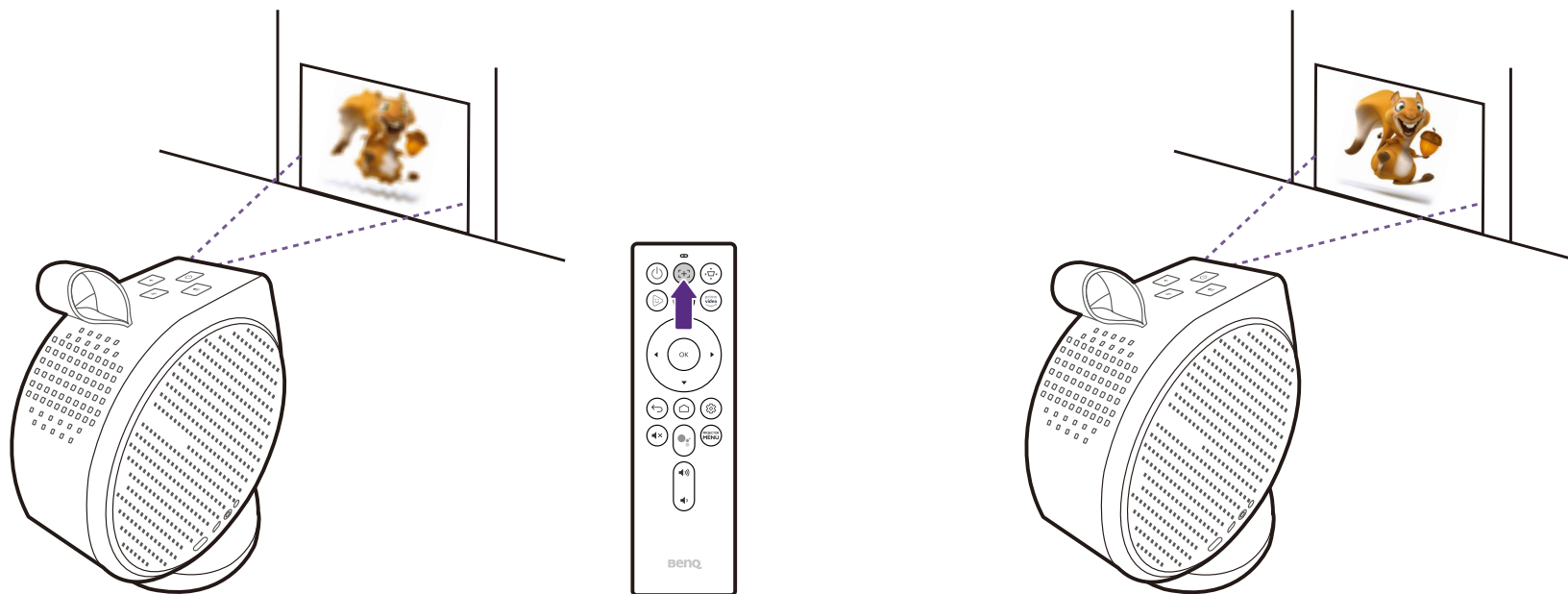



- 
- ! Do not look into the lens while the light is on. The strong light from the light may cause damage to your eyes.
  - You may also allow the projector to automatically focus the image in the settings menu by configuring the **Focus** setting to **Real Time Adjustment** in the settings menu. See [Installation on page 56](#) for more information.
- 

Once the projector has finished automatically adjusting the focus, you can also choose to manually adjust the focus by pressing the left ◀ or right ▶ buttons on the remote control while the focus guide is still on the screen.

## Correcting keystone

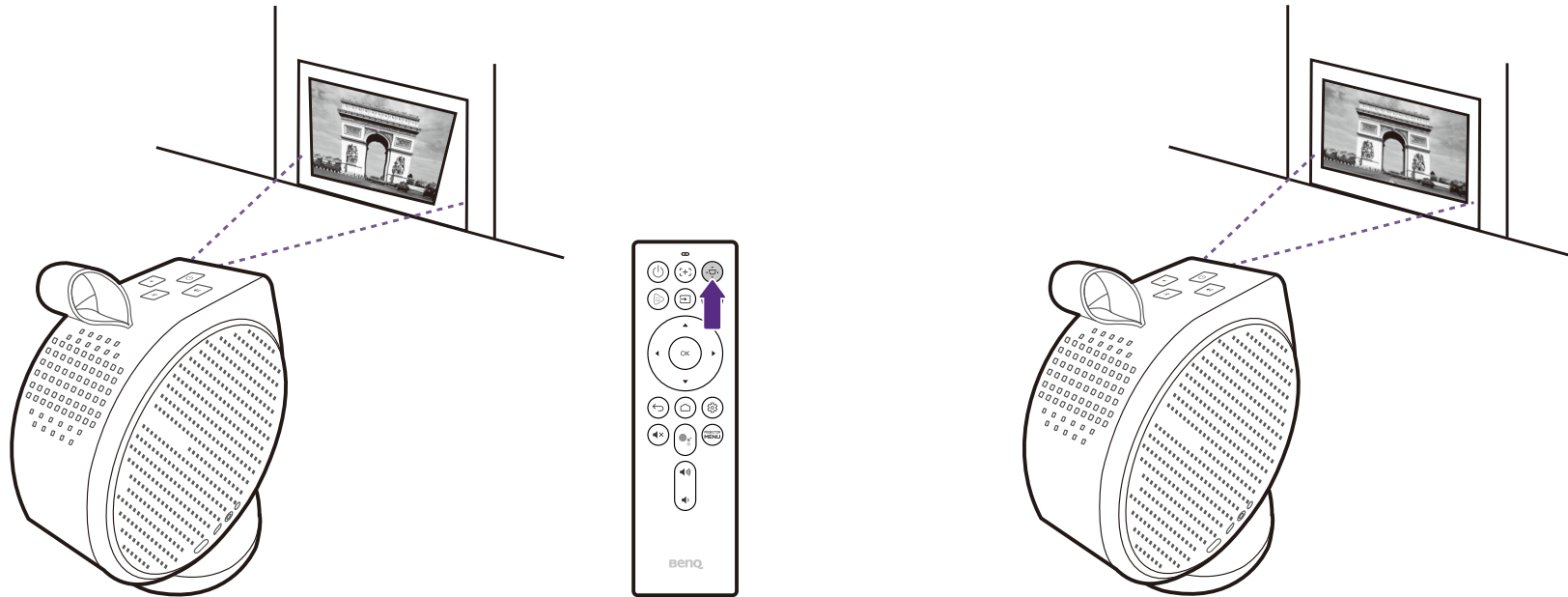
The keystone effect refers to the situation where the projected image is noticeably wider at either the top or bottom. It occurs when the projector is not perpendicular to the screen. To correct the keystone effect press the keystone button  on the remote control and then follow the on-screen instructions to make the adjustments.



When you are done making the adjustments, press  to save your changes and return to the previous menu.

# Android TV

**Android TV** is the projector's operating system that allows you to project videos wirelessly and use streaming apps.

## The **Android TV** home screen

Upon initial startup or when the input source is set to **ATV** the projector will display the **Android TV** interface. If the projector is projecting from a source, you can return to **Android TV** by pressing  $\square$  on your remote control or by selecting **ATV** in the input source menu.

The **Android TV** home screen features following items:

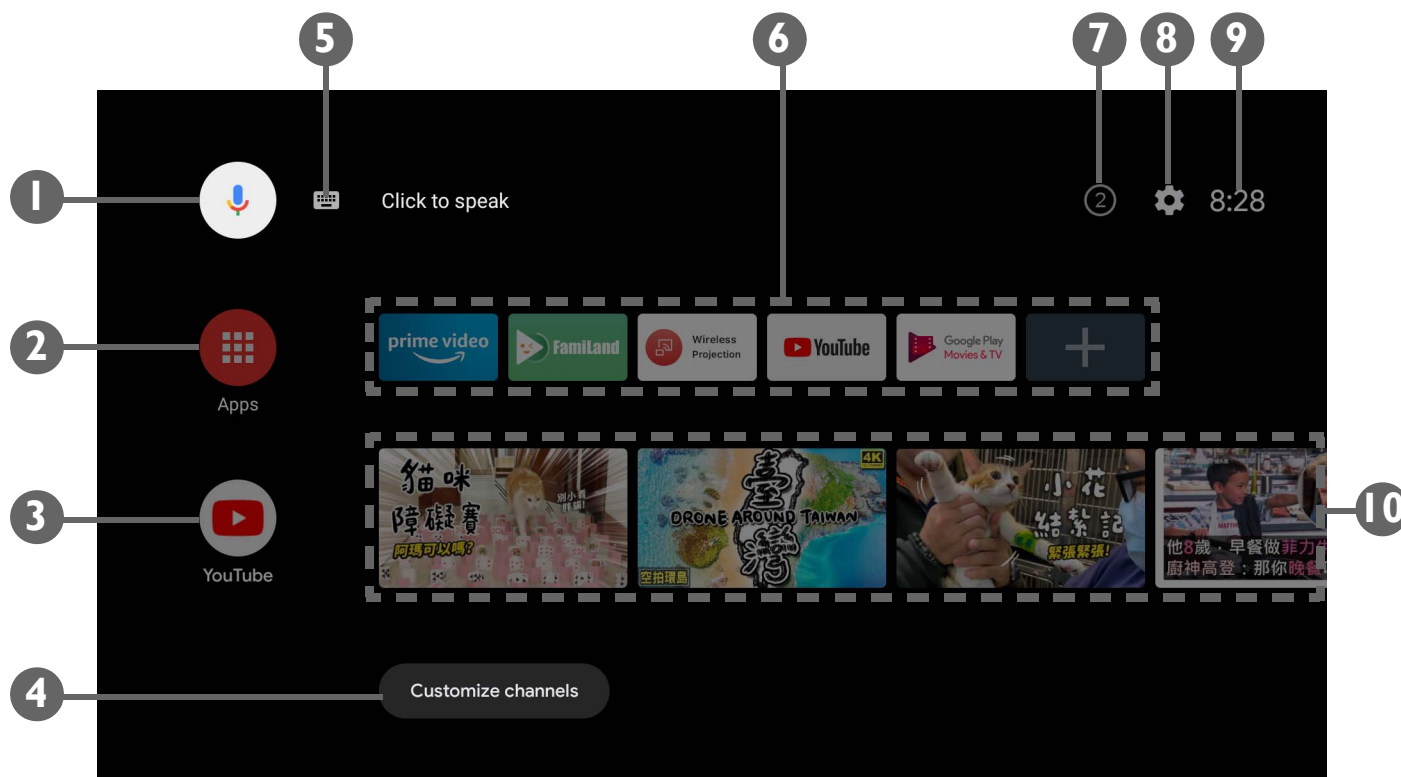

Actual screen may vary based on your **Android TV** version.



No.	Item	Description
1	Google Voice Search / Google Assistant	Enables Google Voice Search / Google Assistant.
2	All apps	Accesses all the installed apps.
3	YouTube	Launches the YouTube app.
4	Customized channels	Allows you to customize app channels that appear on the home screens feed.
5	Search by text	Enables text input to search.
6	Recommended apps or services	Quick access to recommended apps or videos-on-demand services. Select the + button to add app shortcuts to this row.
7	Notifications	Accesses notification(s).
8	Settings	Accesses the Android settings menus.
9	System time	Displays the time.
10	Recommended YouTube videos	Quick access to videos recommended by YouTube.

For more information on Android TV, you can use the following resources:

- For How-to videos on Android TV and FamiLand, scan the QR code below or go to:  
<https://www.benq.com/en-us/knowledge-center/knowledge/how-to-start-benq-smart-home-projector.html>



- For the QS01 ATV dongle user manual, visit [Support.BenQ.com](https://support.benq.com).

# Google Assistant

**Android TV** supports Google Assistant, Google's voice powered virtual assistant service, for basic commands and Google searches. To activate Google Assistant press the Google Assistant button  on the remote control and say your command or question into its microphone. For more information on Google Assistant, including supported commands and phrases, check Google's official website.

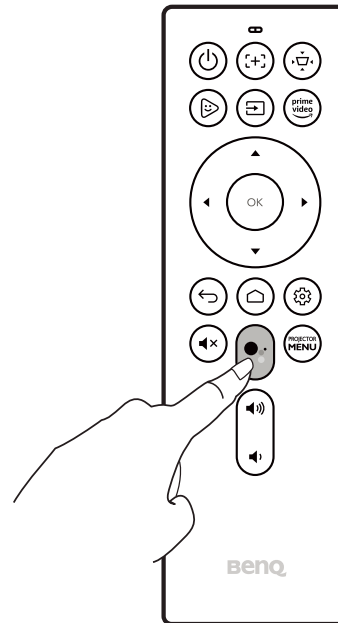

## Playing music via the projector

With the built-in speakers, you can enjoy music playback via the projector without a projection screen. The projector can work as an ordinary speaker or a Bluetooth speaker.

### Using the built-in speaker on the projector

1. Access a music streaming service or a music channel from **Android TV**.
2. Start the music playback.
3. Press the power button  on the projector or remote control to bring up the power menu.
4. Select **Audio-Only Mode**. The screen is turned off while the music playback continues.
5. To stop the playback or to perform other operations, press any key on the remote control to bring the projection screen back.

### Using the projector as a Bluetooth speaker

See [Using the projector as a Bluetooth speaker \(page 50\)](#) for details.

# Connections

You can connect your device to the projector in various ways to project video content.

## Wireless Connection

- Smartphone, tablet, laptop/PC

## Wired Connection (HDMI port)

- A/V device.
- Smartphone, tablet, laptop/PC

## Wired Connection (USB-C port)

- USB-C flash drive
- Smartphone, tablet, laptop/PC



- Devices connected via the USB-C port require a USB-C cable and must support DisplayPort (version 1.1 or above) functionality in order to project video.
  - The USB-C port supports USB Power Delivery and is able to provide power/charge devices connected to it (45W, 15V, 3A).
- 

Furthermore, you can also connect the projector to Bluetooth speakers/headphones to broadcast audio through the speakers/headphones or connect a mobile device to the projector via Bluetooth to broadcast audio through the projector's speakers.

Before making any wireless connections, be sure to:

- Install the provided ATV dongle for wireless connection.
- Place the projector within range of the wireless AP you plan to connect it to.

Before making any wired connections, be sure to:

- Use the correct cables for each source and make sure the cables are firmly inserted.

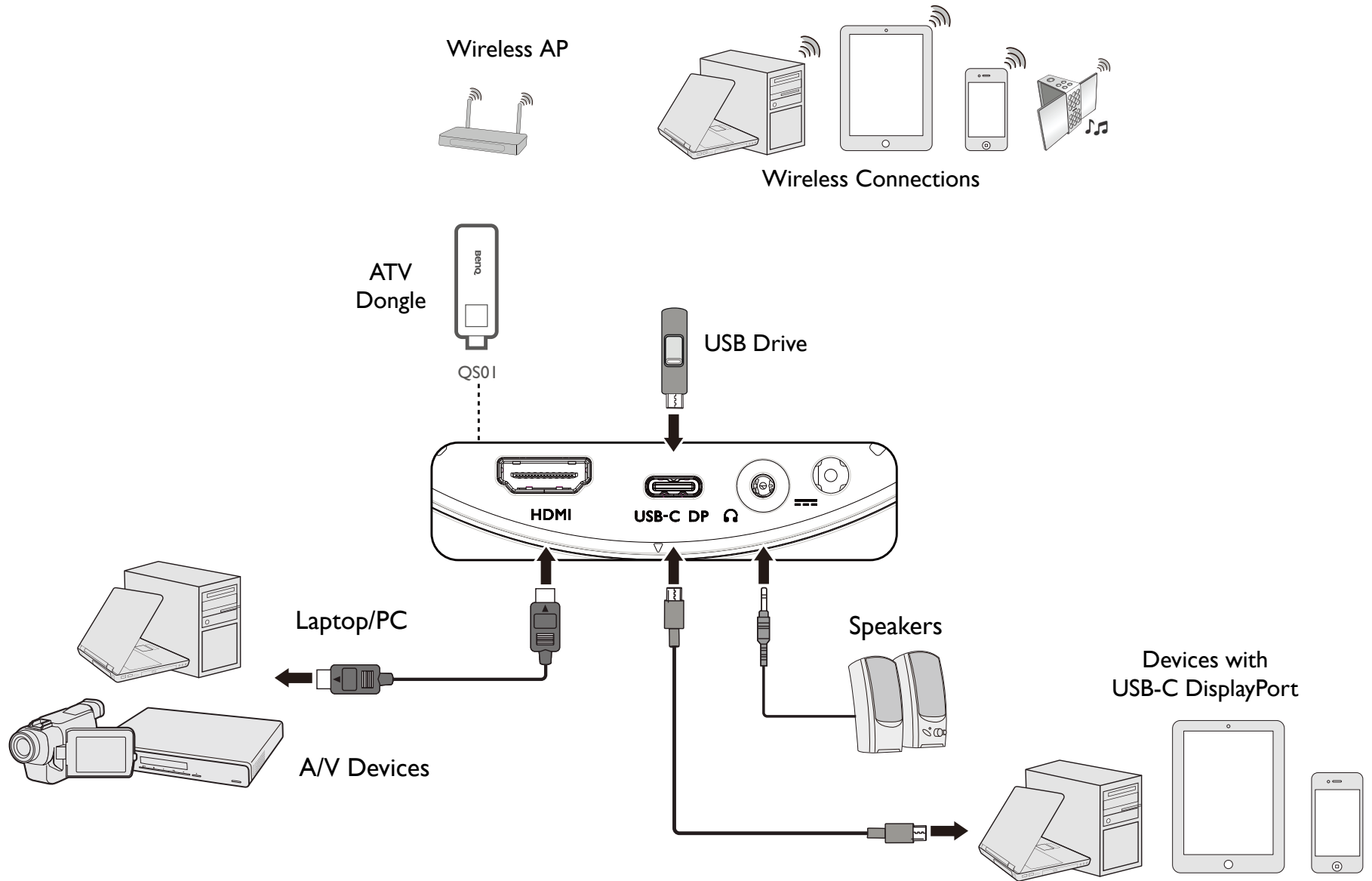

 The illustration above is for reference only.

## Switching between **Android TV** and input sources

By default, the projector will enter the **Android TV** interface any time it is powered on. Once powered on, when a device is connected to one of its input ports the projector will automatically switch over to that input source.

To switch between input sources and **Android TV**, press the source button  on the remote control and select the desired input source from the source menu.

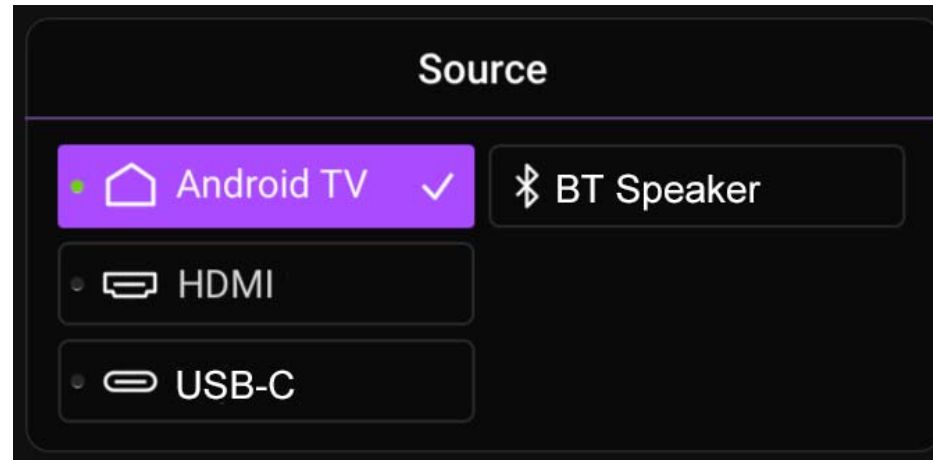

You can also press the home button  on the remote control to return to the **Android TV** home screen at any time.

## Wireless connections

Before you can project wirelessly via the projector you must first connect the projector to a wireless network. To connect your projector to a wireless network or to switch wireless networks, use the **Network & Internet** sub-menu in the **Android TV** settings menu.

## Wireless projection

To wirelessly connect a device or PC to the projector and project video, select **Wireless Projection** in the favorites section of the **Android TV** home screen and then follow the instructions in the QS01 user manual.

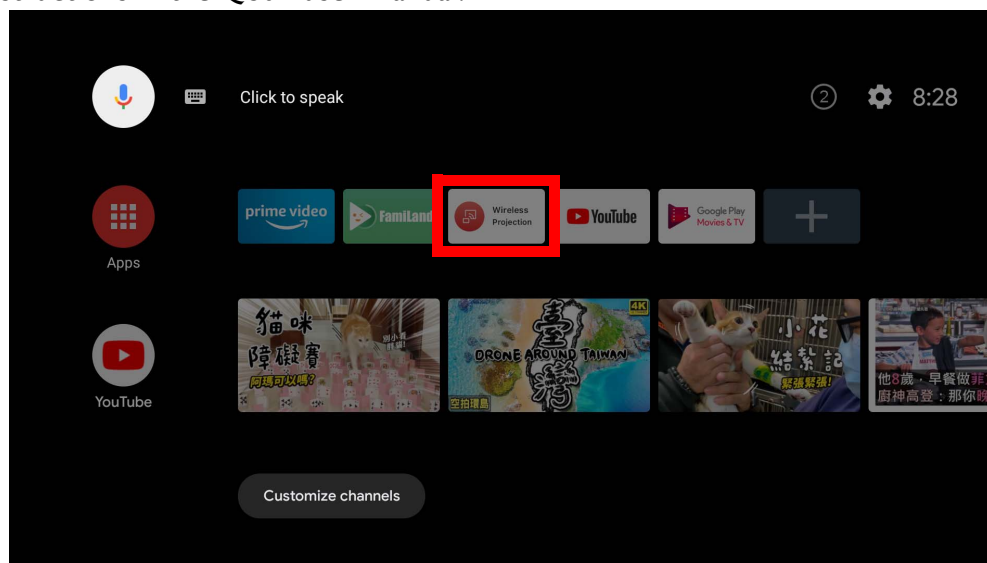

- To download the QS01 user manual, visit [Support.BenQ.com](https://support.benq.com).
- The projector only supports wireless projection via the AirPlay (for iOS devices) or Chromecast protocols (for Android devices). As a result, not all Android devices are able to wirelessly project on the projector. To check if your Android device supports wireless casting via Chromecast, check [support.google.com](https://support.google.com).
- Netflix only supports specific authorized devices and is not natively available on BenQ smart home projectors. Please follow the recommended viewing procedures in [this how-to video](#). Alternatively, download **Apps Manager** from **Google Play** on your projector, and install Netflix. Visit [Support.BenQ.com](https://support.benq.com) and check out the QS01 product page for details.

# Wired connections

## Connecting a device with HDMI or USB-C with DisplayPort

Using an HDMI or USB-C cable you can connect a device that is equipped with HDMI or DisplayPort capabilities to broadcast videos and images on the projector.



- Not all devices with a USB-C port have DisplayPort functionality. Check your device's documentation for clarification.
  - Not all USB-C cables support DisplayPort protocol. Use a USB-C 3.1 Gen 2 cable to ensure compatibility.
- 



To connect a device with HDMI or USB-C with DisplayPort:

1. Connect the device to the HDMI or USB-C port on the projector. A pop-up notification will appear indicating that a device is connected.
  2. Confirm whether you want to project video from the device. The video from the device will be displayed once the signal from the device is detected.
- 



If no signal is detected or the signal is interrupted a message will appear.

---

3. Use the source menu or press the home button  to exit and go back to the **Android TV** home screen.
  4. If the device remains connected and you want to project its video again press the source button , and then select the corresponding port in the source menu.
- 



- Some computers feature HDMI ports that do not transmit audio, in such cases a separate audio cable must be connected to the projector.
  - Some laptops do not turn on their external video ports when connected to a projector. Usually a key combination like **Fn + F3** or CRT/LCD key turns the external display on/off. Locate a function key labeled CRT/LCD or a function key with a monitor symbol on the laptop. Press **Fn** and the labeled function key simultaneously. Refer to your laptop's documentation to discover your laptop's key combination.
-



## Connecting a flash drive

Connect a USB-C drive to the respective port on the projector to play media files stored on the flash drive.

To play media files stored on a flash drive:

1. Connect the flash drive to the USB-C port. A pop-up notification will appear indicating that a storage device is connected.
2. Select the type of media file you want to play.

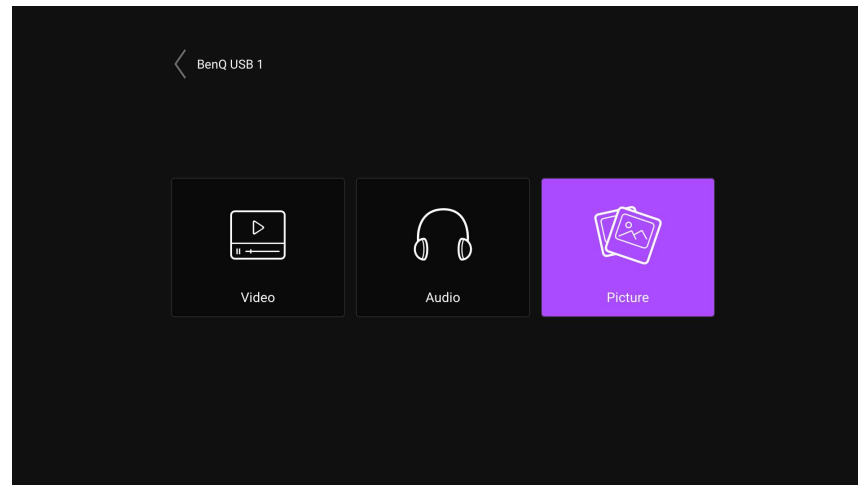

3. Navigate to and select the media file you want play. The projector's media player will launch.

# Bluetooth connections

The projector allows the following types of Bluetooth connections:

- Connect a mobile device to the projector to broadcast audio through the projector's speakers.
- Connect to a Bluetooth-enabled speaker or headphones to output audio directly for greater sound.

## Using the projector as a Bluetooth speaker

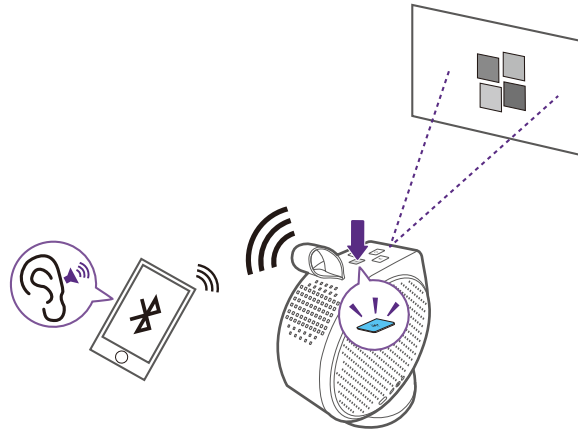

1. Make sure the ATV dongle is installed properly (see [Installing the ATV dongle on page 28](#)).
2. Power on the projector (see [Starting up the projector on page 32](#)).
3. Press the Bluetooth button  on the top side of the projector. The projector will stop projecting and switch over to Bluetooth speaker mode.



You may also enable Bluetooth speaker mode by pressing the source button  on the remote control and selecting **BT Speaker**.

4. Pair your external device to the projector.



After you have successfully paired your mobile device with the projector, pairing information will be stored on both devices and a connection will automatically be made when Bluetooth is enabled on both devices and both devices are within range of each other.



If you are unable to activate Bluetooth mode or if the Bluetooth LED does not illuminate, shut off the projector and check to see if the ATV dongle is properly installed. See [Installing the ATV dongle on page 28](#) for details.

## Ending the Bluetooth connection

In cases where you want to disconnect the mobile device from the projector, either:

- Disconnect from the projector in the Bluetooth menu of your mobile device.
- Press the Bluetooth button  on the projector to return the projector to projector mode.
- Press and hold the power button  on the projector or remote control to power off the projector.

## Pairing/Connecting to a Bluetooth speaker or headphones

The Bluetooth function for a GV30 projector is built in the Android system, whose hardware is independent of other input sources like HDMI. Thus, the Bluetooth function will only be available when using the projector's built-in Android as an input source. In other words, due to current hardware limitations, the projector won't be able to transmit audio using HDMI to external Bluetooth speakers. If you have any further questions, please contact your local customer care team for more assistance.

1. Make sure the ATV dongle is installed properly (see [Installing the ATV dongle on page 28](#)).
2. Power on the projector (see [Starting up the projector on page 32](#)).
3. Press the settings button  on the remote control
4. Select **Remotes & Accessories**.
5. Select **Add accessory**.
6. Activate Bluetooth-pairing mode on the speaker or headphones.
7. Select the speaker or headphones from the device list shown on screen.
8. Select **Pair**.

When the projector and speaker or headphones have successfully connected, the device will be labelled as **Connected** in the **Remotes & Accessories**. You can now output the audio from the ATV to the speaker or headphone.

---

 The projector can only transmit audio from ATV via Bluetooth connection. Even when the projector is switched to other input sources, such as HDMI, as ATV is still running in the background, it will continue to transmit audio from ATV to the connected Bluetooth speaker or headphones.

---

## Disconnecting a Bluetooth speaker or headphones

To disconnect a Bluetooth speaker or headphone from the projector so that it no longer outputs the projector's audio:

1. Press the settings button  on the remote control
2. Select **Remotes & Accessories**.
3. Select the speaker or headphones you want to disconnect from the device list shown on screen.
4. Select **Unpair**.

# Navigating the settings menu

## About the settings menu

To let you make various adjustments or settings on the projector, the projector provides a **Settings** menu. To access the menu, either press the **PROJECTOR MENU** button on the remote control or select **All Projector Settings** from the Android TV **Settings** menu.

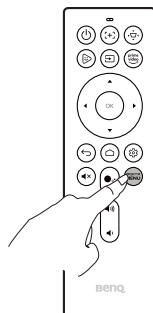

 For settings related to the system including wireless connection, account, and app related setting, use the Android TV **Settings** menu accessible on the home screen. See [The Android TV home screen on page 40](#) for more details.

Under the settings menu there are two subcategories: **Picture & Sounds** and **General**:

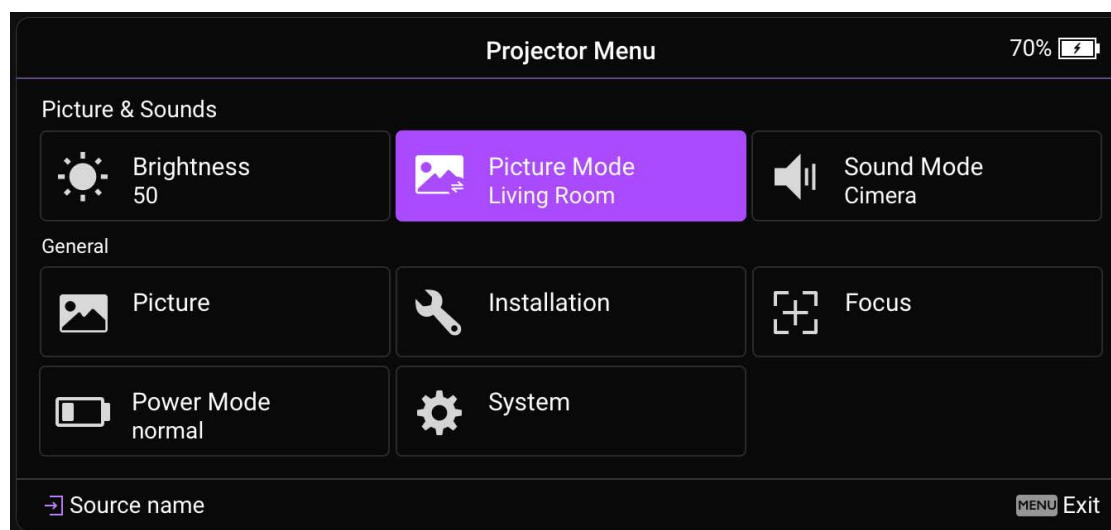

## Using the **Settings** menu

To access the various settings menus:

- Use the arrow buttons (▲/▼/◀/▶) to move through the main settings menus.

- Use **OK** to select the desired menu.

When configuring items within a menu:

- Use the up and down arrow buttons (▲/▼) to move to the item you want to configure.

- Use **OK** to select sub-menu options.

- Use the arrow buttons (▲/▼ ◀/▶) to toggle through the available options.

- Use the back button ↶ to return to the main settings menu.

- Use the home button ◻ to return to the **Android TV** home screen.

## Brightness

Allows you to adjust the brightness of the projector on a scale of 0 to 100.

## Picture Mode

The following table describes the items available in the **Picture Mode** menu:

Item	Options and descriptions
<b>Bright</b>	Maximizes the brightness of the projected image. This mode is suitable for environments where extra-high brightness is required, such as using the projector in well lit rooms.
<b>Living Room</b>	With well-saturated colors and fine-tuned sharpness, this mode is slightly brighter than Cinema mode and suitable for playing TV streaming under a small amount of ambient light.
<b>Game</b>	Picture settings appropriate for playing video games. This mode especially enhances details in dark scenes so that enemies cannot hide.
<b>Sports</b>	With well-saturated colors and a higher brightness level, this mode is best for watching sporting events in a bright room.
<b>Cinema</b>	With accurate colors and deepest contrast at a lower brightness level, this mode is suitable for playing movies in an environment with a bit of ambient light.
<b>Day Time</b>	By brightening dim regions of images, this mode is suitable for use in brightly lit spaces, such as outdoors or in a fully-lit room.

## Sound Mode

**Sound Mode** utilizes sound enhancement technology, which incorporates Waves' algorithms to deliver great effects of the bass and treble and provide you with immersive cinematic audio experience. The available options include: **Standard**, **Cinema**, **Music**, **Game**, and **Sports**.

## Picture

The following table describes the items available in the **Picture** menu:

Item	Options and descriptions
<b>Picture Mode</b>	Allows you to switch between picture modes. See <a href="#">Picture Mode on page 55</a> for more details
<b>Brightness</b>	Allows you to adjust the brightness of the projector on a scale of 0 to 100.
<b>Contrast</b>	The higher the value, the greater the contrast. Use this to set the peak white level after you have previously adjusted the Brightness setting to suit your selected input and viewing environment.
<b>Color</b>	Lower setting produces less saturated colors. If the setting is too high, colors on the image will be overpowering, which makes the image unrealistic.
<b>Sharpness</b>	The higher the value, the sharper the picture becomes.

## Installation

The following table describes the items available in the **Installation** menu:

Item	Options and descriptions
<b>Auto Vertical Keystone</b>	Enables/Disables the projector's automatic keystone adjustment.
<b>Vertical Keystone Correction</b>	Allows you to manually adjust the keystone settings for the projected image. See <a href="#">Correcting keystone on page 39</a> for more details.



Item	Options and descriptions
<b>Aspect Ratio</b>	<p>There are several options to set the image's aspect ratio depending on your input signal source. Options include:</p> <ul style="list-style-type: none"> <li>• <b>Auto:</b> Scales an image proportionally to fit the projector's native resolution in its horizontal or vertical width.</li> <li>• <b>Real:</b> Projects an image as its original resolution and resizes it to fit within the display area. For input signals with lower resolutions, the projected image will be displayed in its original size.</li> <li>• <b>4:3:</b> Scales an image so that it is displayed in the center of the screen with a 4:3 aspect ratio.</li> <li>• <b>16:9:</b> Scales an image so that it is displayed in the center of the screen with a 16:9 aspect ratio.</li> </ul>
<b>Test Pattern</b>	<p>Displays the test pattern grid, which helps you adjust the image size and focus to check if the projected image is free of distortion.</p>
<b>High Altitude Mode</b>	<p>We recommend you use the <b>High Altitude Mode</b> when your environment is between 1500 m - 2000 m above sea level, and ambient temperature is between 0°C to 30°C.</p> <p>Operation under <b>High Altitude Mode</b> may cause a higher decibel operating noise level because of increased fan speed necessary to improve overall system cooling and performance.</p> <p>If you use this projector under other extreme conditions excluding the above, it may display auto shut-down symptoms, which is designed to protect your projector from over-heating. In cases like this, you should switch to <b>High Altitude Mode</b> to solve these symptoms. However, this is not to state that this projector can operate under any and all harsh or extreme conditions.</p> <p> Do not use the <b>High Altitude Mode</b> if your altitude is between 0 m and 1500 m and ambient temperature is between 0°C to 35°C. The projector will be over cooled, if you turn the mode on under such a condition.</p>

## Power Mode

The following table describes the items available in the **Power Mode** menu:

Item	Options and descriptions
<b>Normal</b>	100% LED brightness.
<b>Eco Mode</b>	This setting reduces system noise and power consumption by 30%. If <b>Eco Mode</b> is selected, the light output will be reduced and result in darker projected pictures.
<b>Low Power</b>	Lowers brightness to 50% to extend the LED life.

## Focus

The following table describes the items available in the **Focus** menu:

Item	Options and descriptions
<b>Real Time Adjustment</b>	Allows the projector to adjust the focus settings in real time.
<b>Sensitivity</b>	Allows you to set the level of sensibility the <b>Real Time Adjustment</b> function uses to make the adjustments.
<b>Manual Focus</b>	Allows you to manually adjust the focus for the projected image.

## System

The following table describes the items available in the **System** menu:

Item	Options and descriptions
<b>Language</b>	Sets the language for the projector.  Changing the language setting in this menu will not change the language used in <b>Android TV</b> . To change <b>Android TV</b> 's language use the settings menu on the home screen.
<b>Auto Power Off When Idle</b>	Enables/Disables the automatic shutting off of the projector after the amount of time configured ( <b>5mins, 10mins, 15mins, 20mins, 25mins, and 30mins</b> ).
<b>System Update</b>	Allows you to update the software on the projector via a USB flash drive. This is for service use only.
<b>System Information</b>	Displays hardware/software information for the projector including its device name and serial number.
<b>Projector Information</b>	Displays information on the current status of the projector including the current <b>Detected Resolution, Source, Picture Mode, Power Mode, Color System, Light Usage Time, Firmware Version, and Service Code</b> .
<b>Factory Reset</b>	Returns the projector to its factory default state.

# Maintenance

## Care of the projector

Your projector needs little maintenance. The only thing you have to do on a regular basis is keep the lens clean.

Never remove any parts of the projector. Contact your dealer or local customer service center if the projector fails to operate as expected.

## Cleaning the lens

Clean the lens whenever you notice dirt or dust on the surface.

Before cleaning any part of the projector, turn it off using the proper shutdown procedure (see [Shutting down the projector on page 36](#)), unplug the power cable, and let it cool down completely.

- Use a canister of compressed air to remove dust.
- If there is dirt or smears, use lens-cleaning paper or moisten a soft cloth with lens cleaner and gently wipe the lens surface.
- Never use any type of abrasive pad, alkaline/acid cleaner, scouring powder, or volatile solvent, such as alcohol, benzene, thinner or insecticide. Using such materials or maintaining prolonged contact with rubber or vinyl materials may result in damage to the projector surface and cabinet material.

---

 Never touch the lens with your finger or rub the lens with abrasive materials. Even paper towels can damage the lens coating. Only ever use a proper photographic lens brush, cloth, and cleaning solution. Do not attempt to clean the lens while the projector is switched on or is still hot from previous use.

---

## Storing the projector

To store the projector for an extended time:

- Make sure the temperature and humidity of the storage area are within the recommended range for the projector. Refer to Specifications or consult your dealer about the range.
- Remove the batteries from the remote control.
- Pack the projector in its original packing or equivalent.

## Transporting the projector

It is recommended that you ship the projector with its original packing or equivalent.

## Outdoor use

Anytime the projector is used outdoors, remember to follow the care instructions in this chapter and the cleaning instructions described in [Important safety instructions on page 9](#).

## Extending LED life

The LED headlight includes a bulb which features a light-source life far beyond traditional bulbs, yet it is still a consumable item. To keep the LED life as long as possible, you can change the following settings via the settings menu.

To access the settings menu, see [Using the Settings menu on page 54](#) for details.

## Setting LED Mode

Set the projector **Power Mode** to **Eco Mode** or **Low Power** to extend the LED life.

LED mode	Description
<b>Normal</b>	100% LED brightness.
<b>Eco Mode</b>	This setting reduces system noise and power consumption by 30%. If <b>Eco Mode</b> is selected, the light output will be reduced and result in darker projected pictures.
<b>Low Power</b>	Lowers brightness to 50% to extend the LED life.

1. Press the **PROJECTOR MENU** button on the remote control.
2. Select **Power Mode**.
3. Press (**▲/▼**) to move to your desired mode.
4. When done, press to **⇒** your changes and exit.

# Troubleshooting

If your problems remain after checking this manual, please contact your place of purchase or visit the local website from [Support.BenQ.com](https://Support.BenQ.com) for more support and local customer service.



Support.BenQ.com

Problem	Cause	Remedy
The projector does not turn on.	There is no power from the power cable.	Plug the power cable into the AC inlet on the rear of the projector, and plug the power cable into to the power outlet. If the power outlet has a switch, make sure that it is switched on.
	The battery is running out and in low voltage.	Plug in power adapter to charge the projector until the LED indicator turns solid green; then press and hold the power button on the projector for 3 seconds to turn it on.
The projector cannot project the screen on mobile phones or laptops via USB-C cables.	The mobile phones or laptops do not have DisplayPort functionality.	Make sure the USB-C port on the device has DisplayPort functionality (with a DisplayPort IC inside), supports DisplayPort version 1.1 (or above) and timings as listed in <a href="#">Timing chart on page 68</a> .
	The USB-C cable is not compatible.	Use a USB-C 3.1 Gen 2 cable to ensure sufficient bandwidth for media data transmission.
The projector cannot connect with Bluetooth speakers or headphones.	The Bluetooth function is not enabled.	Make sure the Bluetooth function on both the Bluetooth device and the projector are enabled. See <a href="#">Pairing/Connecting to a Bluetooth speaker or headphones on page 51</a> for more details.
	The Bluetooth device and the projector are not within an 8 meter range of each other.	

Problem	Cause	Remedy
The projector cannot play files in storage devices via the USB-C port.	The storage device is not connected to the projector properly.	Make sure your storage device is fully inserted into the USB-C port on the projector.
	The projector does not support the file formats.	See <a href="#">Supported file formats on page 71</a> for more information about file formats supported by the projector.
Screen brightness is changed.	The adapter is removed.	The light brightness is decreased in <b>Eco Mode</b> and <b>Low Power</b> to support longer projection. If a brighter screen is preferred, connect the power adapter to the projector or change the <b>Power Mode</b> to <b>Normal</b> .
	The adapter is not removed but the <b>Power Mode</b> is switched to <b>Eco Mode</b> or <b>Low Power</b> .	
No input source.	The video source is not turned on or connected correctly.	Turn the video source on and check that the signal cable is connected correctly.
	The projector is not correctly connected to the input source device.	Check the connection. If input source is the USB-C port, make sure the source device supports DisplayPort and is connected to the projector with a USB-C cable.
	The video or audio file format is not supported by the projector.	Make sure the supported file format as described in <a href="#">Supported file formats on page 71</a> is being played, or contact the customer service for assistance.
Image or audio is unstable.	The connection cables are not securely connected to the projector or the signal source.	Correctly connect the cables to the appropriate terminals.
	The Internet bandwidth is limited or over-occupied.	Connect to another wireless AP or to an Internet channel of better speed.
	The projector is out of effective range of Bluetooth connection.	Make sure the projector is within the effective range of Bluetooth connection. Make sure there is as less radio frequency interference as possible when using a 2.4G network.

Problem	Cause	Remedy
Picture is blurred.	The projection lens is not correctly focused.	Adjust the focus of the lens using focus button on the remote control.
	The projector and the screen are not aligned properly.	Adjust the projection angle and direction as well as the height of this projector if necessary.
Remote control does not work correctly.	The batteries are out of power.	Replace both of the batteries with new ones.
	There is an obstacle between the remote control and the projector.	Remove the obstacle.
	You are too far away from the projector.	Stand within 8 meters (26.2 feet) of the projector.
The projector cannot connect to the desired SSID.	The handshaking between the projector and the router does not follow IEEE 802.11 protocols.	<ul style="list-style-type: none"> <li>• For 2.4G frequency, make sure the wireless mode of the router is configured as 802.11g/n or 802.11n.</li> <li>• For 5G frequency, make sure the wireless mode of the router is configured as 802.11n.</li> </ul>



# Specifications

## Projector specifications



All specifications are subject to change without notice.

Specifications	
<b>Projection System</b>	DLP
<b>DMD Type</b>	0.23"
<b>Native Resolution</b>	1280 x 720 pixels
<b>Brightness</b>	300 ANSI Lumens
<b>Contrast Ratio</b>	100,000:1
<b>Display Color</b>	30 Bits (16.7 Billion Colors)
<b>Aspect Ratio</b>	16:9
<b>Light Source</b>	Osram LED
<b>Light Source Life<sup>(1)</sup></b>	20,000/30,000 hours (Normal/Eco)
<b>Throw Ratio</b>	1.2 (37.6"@1M)
<b>Zoom Ratio</b>	Fixed
<b>Keystone Correction</b>	Auto Vertical $\pm$ 40 Degrees
<b>Projection Offset</b>	100% $\pm$ 5%
<b>Projection Size</b>	30 to 100 inches

Specifications		
<b>Interface</b>	<ul style="list-style-type: none"> <li>• USB-C (DisplayPort 1.2)(5V/1.5A) x 1</li> <li>• HDMI 1.4b (w/o 3D) x 1</li> <li>• 3.5mm Audio Out x 1</li> </ul>	
<b>Power</b>	<b>DC Supply</b>	
	Frequency	AC 100 to 240V 50/60HZ 1.5A
	Power Consumption	42W/34W/29W (Normal/Eco/Low Power)
	<b>Battery</b>	
	Type	Lithium-ion battery
	Capacity	4800mAh/11.1V
	Battery Life Cycle	500 cycles
	Battery Life	2.5 hours
<b>Built-in Speaker</b>	4W x 2 + 8W Woofer, 2.1 Channels Chamber Speakers	
<b>Resolution Support</b>	HDMI: up to 3840 x 2160@30 USB-C: up to 1920 x 1080@60	
<b>Horizontal Frequency</b>	15 to 102 KHz	
<b>Vertical Scan Rate</b>	23 to 85 Hz	
<b>Noise Level (Normal/Eco)</b>	29dBA/27dBA	
<b>HDTV Compatibility</b>	23 to 85 Hz	
<b>Operating Temperature</b>	0 to 40 °C	
<b>Storage Temperature</b>	-20 to 60 °C	
<b>Operating / Storage Relative Humidity</b>	10% to 90% (without condensation)	



- LED life results will vary depending on environmental conditions and usage.
  - The performance of WLAN and Bluetooth might be disturbed by distance and obstacles.
-

## Timing chart

### Supported timing for video input

Timing	Resolution	H. Frequency (KHz)	V. Frequency (KHz)	Dot Clock Frequency (MHz)
480i	720 (1440) x 480	15.73	59.94	27
480p	720 x 480	31.47	59.94	27
576i	720 (1440) x 576	15.63	50	27
576p	720 x 576	31.25	50	27
720/50p	1280 x 720	37.5	50	74.25
720/60p	1280 x 720	45	60	74.25
1080/24p	1920 x 1080	27	24	74.25
1080/25p	1920 x 1080	28.13	25	74.25
1080/30p	1920 x 1080	33.75	30	74.25
1080/50i	1920 x 1080	28.13	50	74.25
1080/60i	1920 x 1080	33.75	60	74.25
1080/50p	1920 x 1080	56.25	50	148.5
1080/60p	1920 x 1080	67.5	60	148.5
2160/24p (HDMI port only)	3840 x 2160*	54	24	297
2160/25p (HDMI port only)	3840 x 2160*	56.25	25	297
2160/30p (HDMI port only)	3840 x 2160*	67.5	30	297



Supported by HDMI 2.0 only.

## Supported timing for PC input

Resolution	Mode	Refresh Rate (Hz)	H. Frequency (KHz)	Dot Clock Frequency (MHz)
640 x 480	VGA_60	59.940	31.469	25.175
	VGA_72	72.809	37.861	31.500
	VGA_75	75.000	37.500	31.500
	VGA_85	85.008	43.269	36.000
720 x 400	720 x 400_70	70.087	31.469	28.322
800 x 600	SVGA_60	60.317	37.879	40.000
	SVGA_72	72.188	48.077	50.000
	SVGA_75	75.000	46.875	49.500
	SVGA_85	85.061	53.674	56.250
1024 x 768	XGA_60	60.004	48.363	65.000
	XGA_70	70.069	56.476	75.000
	XGA_75	75.029	60.023	78.750
	XGA_85	84.997	68.667	94.500
1152 x 864	1152 x 864_75	75.000	67.500	108.000
1280 x 720	1280 x 720_60	60.000	45.000	74.250
1280 x 768	1280 x 768_60	59.870	47.776	79.500

Resolution	Mode	Refresh Rate (Hz)	H. Frequency (KHz)	Dot Clock Frequency (MHz)
1280 x 800	SVGA_60	59.810	49.702	83.500
	SVGA_75	74.934	62.795	106.500
	XGA_85	84.880	71.554	122.500
1280 x 1024	SXGA_60	60.020	63.981	108.000
	SXGA_75	75.025	79.976	135.000
1280 x 960	1280 x 960_60	60.000	60.000	108.000
	1280 x 960_85	85.002	85.938	148.500
1360 x 768	1360 x 768_60	60.015	47.712	85.500
1440 x 900	WXGA+_60	59.887	55.935	106.500
1440 x 1050	SXGA+_60	59.978	65.317	121.750
1680 x 1050	1680 x 1050_60	59.954	65.290	146.250
640 x 480@67 Hz (HDMI port only)	MAC13	66.667	35.000	30.240
832 x 624@75 Hz (HDMI port only)	MAC16	74.546	49.722	57.280
1024 x 768@75 Hz	MAC19	75.020	60.241	80.000
1152 x 870@75 Hz	MAC21	75.020	68.680	100.000
1920 x 1080@60 Hz	1920 x 1080_60	60.000	67.500	148.500
3840 x 2160 (HDMI port only)	3840 x 2160_30	30.000	67.500	297.000

---

 The timings showing above may not be supported for due to EDID file and VGA graphic card limitations. It is possible that some timings cannot be chosen.

---

## Supported file formats

File type	File extension
Documents	N/A
Photos	JPG(.jpg, .jpeg), PNG(.png), BMP(.bmp)
Music	MP3(.mp3), WAV(.wav), WMA(.wma), FLAC(.flac), AAC(.aac), OGG(.ogg)
Video	MPEG program stream (.mpg, .mpeg) MPEG transport stream (.ts, .trp, .tp) ASF(.asf) WMV(.wmv) AVI(.avi) MKV(.mkv)
Subtitles	N/A

---

 Bit rate range: If the peak bit rate of a video file is larger than 10MB, it might cause video playback lag.

---

# Appendix

## Installing the projector on a tripod (purchased separately)

Use a tripod plate to mount the projector onto a tripod:

1. Install the tripod's quick release plate to the projector's tripod screw hole and tighten the plate's screw.

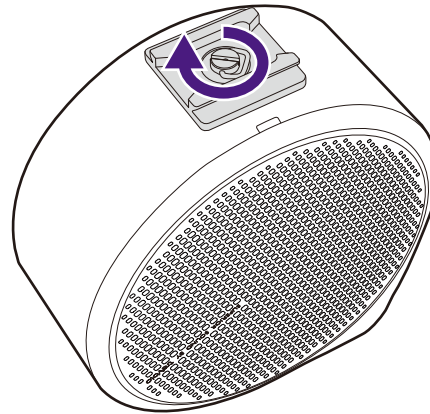

2. Install the projector onto the tripod.

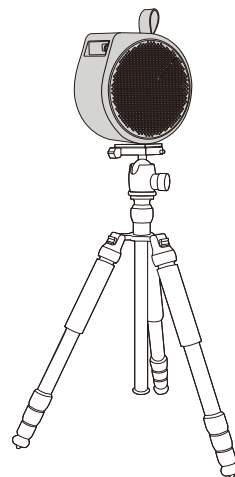



# Copyright and disclaimer

## Copyright

Copyright © 2021 by BenQ Corporation. All rights reserved. No part of this publication may be reproduced, transmitted, transcribed, stored in a retrieval system or translated into any language or computer language, in any form or by any means, electronic, mechanical, magnetic, optical, chemical, manual or otherwise, without the prior written permission of BenQ Corporation.

All other logos, products, or company names mentioned in this manual may be the registered trademarks or copyrights of their respective companies, and are used for informational purposes only.

Android™ is a trademark of Google LLC.

The Bluetooth® word mark and logos are registered trademarks owned by Bluetooth SIG, Inc. and any use of such marks by BenQ Corporation is under license.

iOS is a trademark or registered trademark of Cisco in the U.S. and other countries and is used under license.

macOS® is a trademark of Apple Inc., registered in the U.S. and other countries.

USB-C™ is a trademark of the USB Implementers Forum.

## Disclaimer

BenQ Corporation makes no representations or warranties, either expressed or implied, with respect to the contents hereof and specifically disclaims any warranties, merchantability or fitness for any particular purpose. Further, BenQ Corporation reserves the right to revise this publication and to make changes from time to time in the contents hereof without obligation of BenQ Corporation to notify any person of such revision or changes. This user manual aims to provide the most updated and accurate information to customers, and thus all contents may be modified from time to time without prior notice. Please visit <http://www.benq.com> for the latest version of this manual.

## Warranty

BenQ warrants this product against any defects in material and workmanship, under normal usage and storage.

Proof of purchase date will be required with any warranty claim. In the event this product is found to be defective within the warranty period, BenQ's only obligation and your exclusive remedy shall be replacement of any defective parts (labor included). To obtain warranty service, immediately notify the dealer from which you purchased the product of any defects.

Important: The above warranty shall be void if the customer fails to operate the product in accordance with BenQ's written instructions, especially the ambient humidity must be in-between 10% and 90%, temperature in-between 0°C and 40°C, altitude lower than 2000 meters, and avoiding to operate the projector in a dusty environment. This warranty gives you specific legal rights, and you may have other rights which vary from country to country.

For other information, please visit [www.BenQ.com](http://www.BenQ.com).

## Statement regarding hyperlinks and third-party websites

BenQ is not responsible for the content of the websites or of similar resources, which are maintained and controlled by third parties, that may be linked from this product. Providing links to those websites or to similar resources does not mean that BenQ makes any warranty or representation to their content by expression or by implication.

Any third party content or service preinstalled in this product is provided "as is". BenQ does not, by expression or by implication, make any warrant to the content or to the services provided by third parties. BenQ does not warrant or guarantee that the content or services provided by third parties are accurate, effective, most up-to-date, legal, or complete. Under no circumstances shall BenQ be liable for the content or services provided by third parties including their negligence.

Services provided by third parties may be terminated temporarily or permanently. BenQ does not warrant or guarantee that any content or services provided by third parties are in good condition at any time, and is not liable for the termination of the said content and services.

In addition, BenQ is not involved in any transactions you conduct in the websites or similar resources maintained by third parties.

You should contact the content or service providers for any questions, concerns, or disputes.