



IL430 I / IL550 I  
Interactive Flat Panel  
User Manual



## Disclaimer

BenQ Corporation makes no representations or warranties, either expressed or implied, with respect to the contents of this document. BenQ Corporation reserves the right to revise this publication and to make changes from time to time in the contents thereof without obligation to notify any person of such revision or changes.

### HDMI trademark disclaimer

The terms HDMI and HDMI High-Definition Multimedia Interface, and the HDMI Logo are trademarks or registered trademarks of HDMI Licensing Administrator, Inc. in the United States and other countries.



## Copyright

Copyright 2021 BenQ Corporation. All rights reserved. No part of this publication may be reproduced, transmitted, transcribed, stored in a retrieval system or translated into any language or computer language, in any form or by any means, electronic, mechanical, magnetic, optical, chemical, manual or otherwise, without the prior written permission of BenQ Corporation.

## Product support

This document aims to provide the most updated and accurate information to customers, and thus all contents may be modified from time to time without prior notice. Please visit the website for the latest version of this document and other product information. Available files vary by model.

1. Make sure your computer is connected to the Internet.
2. Visit the local website from [www.BenQ.com](http://www.BenQ.com). The website layout and content may vary by region/country.
  - User manual and related document: [www.BenQ.com](http://www.BenQ.com) > **Business** > **SUPPORT** > **Downloads** > model name > **User Manual**
  - (EU only) Dismantled information: Available on the user manual download page. This document is provided based on Regulation (EU) 2019/2021 to repair or recycle your product. Always contact the local customer service for servicing within the warranty period. If you wish to repair an out-of-warranty product, you are recommended to go to a qualified service personnel and obtain repair parts from BenQ to ensure compatibility. Do not disassemble the product unless you are aware of the consequences. If you cannot find the dismantled information on your product, contact the local customer service for assistance.

# Table of Contents

Product support.....	3
Safety warnings and precautions .....	6
Important safety instructions.....	7
Notes on this display .....	7
Notes on the LCD panel of this display .....	7
Safety notice for remote control .....	8
Battery safety notice .....	8
BenQ ecoFACTS .....	9
Package contents .....	10
Setting up the display .....	11
Mounting the display .....	11
Parts of the display and their functions .....	13
Rear panel.....	13
Input/output terminals .....	14
Remote control.....	17
Using the remote control .....	19
Connection .....	21
Connecting the VGA input.....	21
Connecting the digital inputs.....	22
Connecting the touch module .....	23
Connecting the video output.....	24
Connecting to serial port .....	25
Connecting power .....	26
Basic operations.....	27
Turning the display on or off.....	27
Initial setup .....	28
OSD Setting .....	28
Switching input signals.....	28
Downloading software.....	29
Setting up the Internet connection.....	29
Updating software.....	31
Adjusting audio volume level.....	32



Important instructions for using the touch screen.....	37
<b>Menu operations</b> .....	<b>38</b>
Settings menu .....	38
<b>Android system interface</b> .....	<b>51</b>
Main screen.....	51
<b>All Apps</b> .....	<b>53</b>
<b>Product information</b> .....	<b>66</b>
Specifications .....	66
Dimensions (IL4301).....	68
Dimensions (IL5501).....	69
Supported input signal resolution.....	70
<b>Troubleshooting</b> .....	<b>71</b>
<b>Accessibility Requirements for Rehabilitation Act of 1973, Section 508</b> .....	<b>74</b>

## Safety warnings and precautions



The lightning flash with arrowhead symbol, within an equilateral triangle, is intended to alert the user to the presence of uninsulated “dangerous voltage” within the product’s enclosure that may be of sufficient magnitude to constitute a risk of electric shock to persons.



The exclamation point within an equilateral triangle is intended to alert the user to the presence of important operating and maintenance (servicing) instructions in the literature accompanying the appliance.



### THIS EQUIPMENT MUST BE GROUNDED

To ensure safe operation, the three-pin plug must be inserted only into a standard three-pin power outlet which is effectively grounded through normal household wiring. Extension cords used with the equipment must have three cores and be correctly wired to provide connection to the ground. Wrongly wired extension cords are a major cause of fatalities.

The fact that the equipment operates satisfactorily does not imply that the power outlet is grounded or that the installation is completely safe. For your safety, if you are in any doubt about the effective grounding of the power outlet, please consult a qualified electrician.

- The mains plug of the power supply cord shall remain readily operable. The AC receptacle (mains socket outlet) shall be installed near the equipment and shall be easily accessible. To completely disconnect this equipment from the AC mains, disconnect the power cord plug from the AC receptacle.
- Do not place this display on an uneven, sloping or unstable surface (such as a trolley) where it may fall and cause damage to itself or others.
- Do not place this display near water, like a spa or pool, or in a position which will allow the splashing or spraying of water onto the display, like in front of an open window where rain water may enter.
- Do not install this display in a confined space without proper ventilation and air circulation, such as in a closed cabinet. Allow proper space around the display for dissipating heat inside. Do not block any openings and vents on the display. Overheating may result in hazards and electric shock.
- Installation of this display should only be performed by a qualified technician. Failure to install this display properly may cause injuries and damages to the personnels and the display itself. Check the installation regularly and maintain the display periodically to ensure the best working condition.
- Use only the accessories approved or recommended by the manufacturer to mount this display. Using wrong or unsuitable accessories may cause the display to fall and result in serious personal injuries. Make sure that the surface and fixing points are strong enough to sustain the weight of the display.
- To reduce the risk of electric shock, do not remove covers. No user serviceable parts inside. Refer servicing to qualified service personnel.
- To prevent personal injuries, mounting the display or installing desktop stands is required before use.

## Important safety instructions

1. Read these instructions.
2. Keep these instructions.
3. Heed all warnings.
4. Follow all instructions.
5. Do not use this apparatus near water.
6. Clean only with dry cloth.
7. Do not block any ventilation openings. Install in accordance with the manufacturer's instructions.
8. Do not install near any heat sources such as radiators, heat registers, stoves, or other apparatus (including amplifiers) that produce heat.
9. Do not defeat the safety purpose of the polarized or grounding-type plug. A polarized plug has two blades with one wider than the other. A grounding-type plug has two blades and a third grounding prong. The wide blade or the third prong are provided for your safety. If the provided plug does not fit into your outlet, consult an electrician for replacement of the obsolete outlet.
10. Protect the power cord from being walked on or pinched particularly at plugs, convenience receptacles, and the point where they exit from the apparatus.
11. Only use attachments/accessories specified by the manufacturer.
12. Use only with the cart, stand, tripod, bracket, or table specified by the manufacturer, or sold with the apparatus. When a cart is used, use caution when moving the cart/apparatus combination to avoid injury from tip-over.
13. Unplug this apparatus during lightning storms or when unused for long periods of time.
14. Refer all servicing to qualified service personnel. Servicing is required when the apparatus has been damaged in any way, such as power-supply cord or plug is damaged, liquid has been spilled or objects have fallen into the apparatus, the apparatus has been exposed to rain or moisture, does not operate normally, or has been dropped.



### Notes on this display

- To prevent the risk of physical injuries, do not attempt to lift the display alone.
- Make sure you have four or more people available to help lift or a flat cart to transport the display to its final location.
- Keep the display horizontal as much as possible.
- Clear a floor space before unpacking.
- This display is not for individual use.

### Notes on the LCD panel of this display

- The Liquid Crystal Display (LCD) panel of this display has a very thin protective layer of glass which is liable to marking or scratching, and cracking if struck or pressured. The liquid crystal substrate is also liable to damage under excessive force or extreme temperatures. Please handle with care.
- The response time and brightness of the LCD panel may vary with the ambient temperature.

- Avoid placing the display in direct sun or where direct sun or spot lighting will shine onto the LCD panel, as the heat may damage the panel and the external casing of the display, and the bright light will make viewing the display more difficult than necessary.
- The LCD panel consists of individual pixels to display images and is manufactured according to the design specifications. While 99.9% of these pixels work normally, 0.01% of the pixels may remain constantly lit (in red, blue or green) or unlit. This is a technical limitation of the LCD technology and is not a defect.
- LCD screens, like plasma (PDP) and conventional CRT (Cathode Ray Tube) screens, are also susceptible to 'screen burn-in' or 'image retention' which can be found on the screen as visible fixed lines and shades. To avoid such damage to the screen, avoid displaying still images (like On-Screen Display menus, TV station logos, fixed/inactive text or icons) for more than 30 minutes. Change the aspect ratio from time to time. Fill the entire screen with the image and eliminate the black bars whenever possible. Avoid displaying images in 16:9 aspect ratio over a long period of time, otherwise there may be visible burn marks on the screen as two vertical lines.  
Note: Under certain circumstances, condensation may occur on the inner side of the cover glass, it's a natural phenomenon and will not affect the operation of the display. This condensation will usually disappear after around 2 hours of normal operation.
- RE series does not offer image retention function, for more information, please refer to installation guide. If a still image is required for a display, it is recommended to enable **Pixel shift**.
- RE series does not support portrait use; portrait use may cause display damage. BenQ warranty will not cover faulty usage.

## Safety notice for remote control

- Do not put the remote control in the direct heat, humidity, and avoid fire.
- Do not drop the remote control.
- Do not expose the remote control to water or moisture. Failure to do so could result in malfunction.
- Confirm there is no object between the remote control and the remote sensor of the product.
- When the remote control will not be used for an extended period, remove the batteries.

## Battery safety notice

The use of the wrong type of batteries may cause chemical leaks or explosion. Please note the following:

- Always ensure that the batteries are inserted with the positive and negative terminals in the correct direction as shown in the battery compartment.
- Different types of batteries have different characteristics. Do not mix different types.
- Do not mix old and new batteries. Mixing old and new batteries will shorten battery life or cause chemical leaks from the old batteries.
- When batteries fail to function, replace them immediately.
- Chemicals which leak from batteries may cause skin irritation. If any chemical matter seeps out of the batteries, wipe it up immediately using a dry cloth, and replace the batteries as soon as possible.

- Due to varying storage conditions, the battery life for the batteries included with your product may be shortened. Replace them within 3 months or as soon as you can after initial use.
- There may be local restrictions on the disposal or recycling of batteries. Consult your local regulations or waste disposal provider.

## BenQ ecoFACTS

BenQ has been dedicated to the design and development of greener product as part of its aspiration to realize the ideal of the “Bringing Enjoyment 'N Quality to Life” corporate vision with the ultimate goal to achieve a low-carbon society. Besides meeting international regulatory requirement and standards pertaining to environmental management, BenQ has spared no efforts in pushing our initiatives further to incorporate life cycle design in the aspects of material selection, manufacturing, packaging, transportation, using and disposal of the products. BenQ ecoFACTS label lists key eco-friendly design highlights of each product, hoping to ensure that consumers make informed green choices at purchase. Check out BenQ's CSR Website at <http://csr.BenQ.com/> for more details on BenQ's environmental commitments and achievements.



## Package contents

Open the sales package and check the contents. If any item is missing or damaged, please contact your dealer immediately.



LCD display

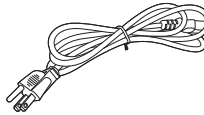

Power cord (By Region)

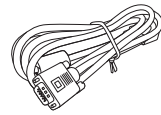

VGA cable x 1

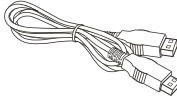

HDMI cable x 1

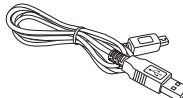

USB cable x 1

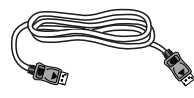

DP cable x 1



Audio cable x 1

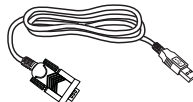

RS232-to-USB cable x 1



IR extender cable x 1



Remote control

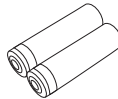

AAA battery x 2



Quick start guide



- The type of power cord supplied may differ from that illustrated depending on your region of purchase.
- Before discarding the package, check that you haven't left any accessories inside the box.
- Dispose of packaging materials wisely. You can recycle the cardboard carton. Consider storing the package (if possible) for future transport of the display.
- Do not leave plastic bags within reach of young children or babies.

# Setting up the display

## Mounting the display

You can install the display on a vertical surface with a suitable wall mounting bracket. Please pay attention to the following notes during installation:

- This display should be installed by at least two adult persons. Attempting to install this display by only one person may result in danger and injuries.
- Refer the installation to qualified technicians. Improper installation may cause the display to fall or malfunction.
- Stability Hazard: The flat panel may fall, causing serious personal injury or death. To prevent injury, this flat panel must be securely attached to the wall in accordance with the installation instructions.

## Installing the display on a wall

1. Place a clean, dry and lint-free cloth on a flat, horizontal and object-free surface. Make sure that the size of the cloth is larger than the display.
2. Gently lay the display on the cloth with the LCD screen facing down.
3. Remove the desktop stands from the display if installed.
4. Identify the wall mounting screw holes on the back of the display as shown in the illustration.

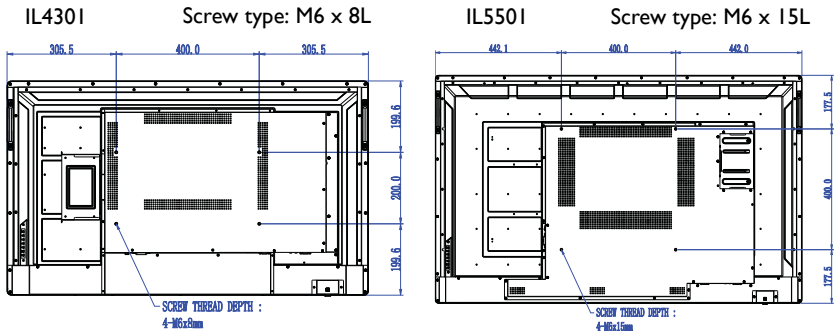

5. Install the wall mounting bracket on the display and attach the display to the wall according to the mounting bracket's instructions. The length of the screw should exceed the thickness of the wall mounting bracket by at least 25 mm. Make sure that all screws are tightened and secured properly. (Recommended torque: 470 - 635N•cm). The mounting means should be strong enough to bear the weight of the display.

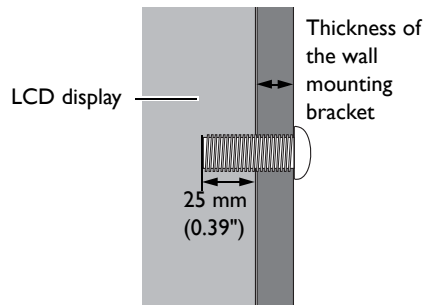



- To maintain proper ventilation, keep at least 10 mm of clear space from the back cover of the display to the wall.
- Please consult a professional technician for wall mount installations. The manufacturer accepts no liability for installations not performed by a professional technician.

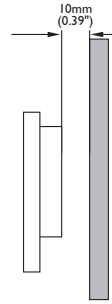

## Mounting in portrait orientation

This display can be installed in both landscape and portrait orientation.

When mounting the display in portrait orientation, rotate the display 90 degrees counter-clockwise as illustrated ensuring that the IR sensor of the display is orientated rightward from the front of the display.

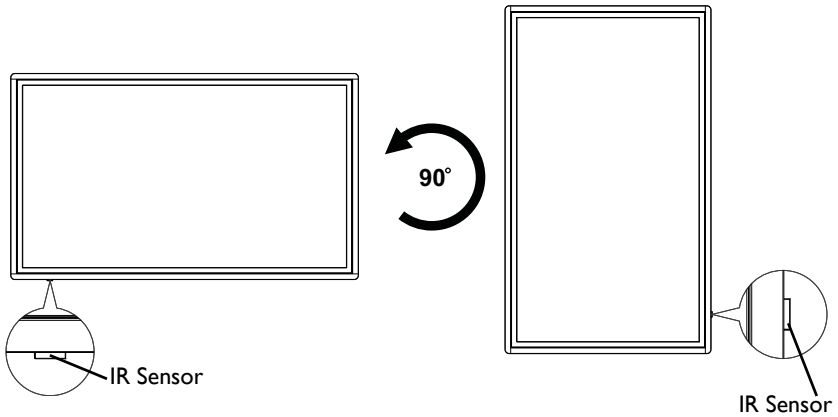



## Parts of the display and their functions

### Rear panel

#### IL430I

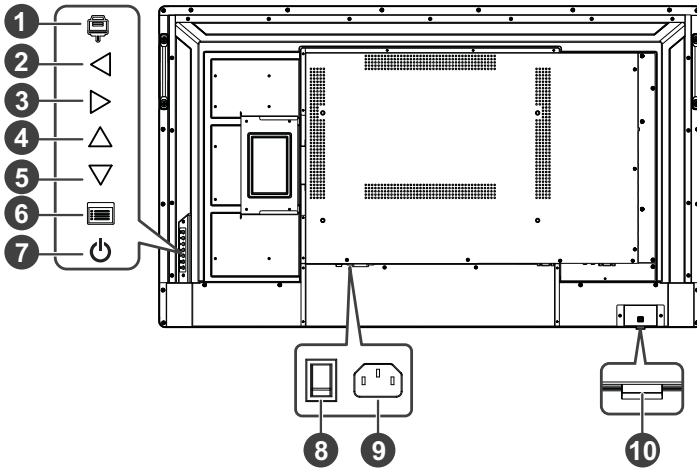

#### IL550I

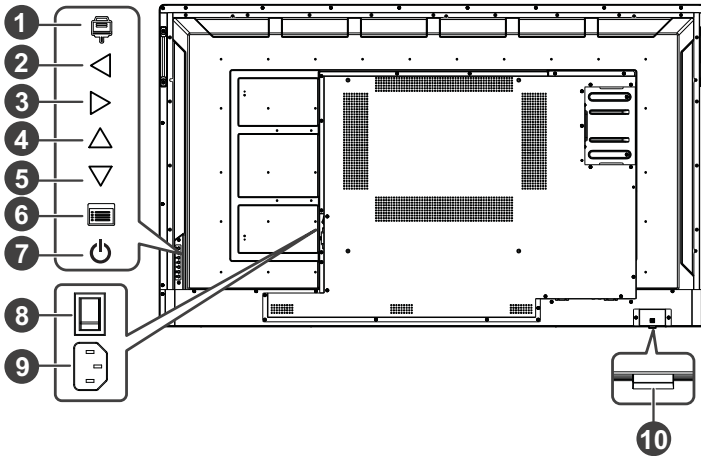

No.	Name	Description
1	Input (📺)	<ul style="list-style-type: none"> <li>• Opens the input source menu.</li> <li>• Confirms a selection in the OSD menu.</li> </ul>
2	Left (<)	<ul style="list-style-type: none"> <li>• Decreases the volume.</li> <li>• Scrolls leftward in the OSD menu.</li> </ul>

No.	Name	Description
3	Right (▷)	<ul style="list-style-type: none"> <li>Increases the volume.</li> <li>Scrolls rightward in the OSD menu.</li> </ul>
4	Up (△)	Scrolls up in the OSD or input source menu.
5	Down (▽)	Scrolls down in the OSD or input source menu.
6	Menu (☰)	Opens/closes the OSD menu.
7	Power (⏻)	Turns the display on/off.
8	Power Switch	Turns on/off the power supplied from the AC IN port.
9	AC IN port	Connects to a power outlet through the supplied power cord.
10	Remote Control Sensor & Power Status Indicator	<ul style="list-style-type: none"> <li>Receives signals from the remote control.</li> <li>Indicates the operating status of the display.</li> </ul>

## Input/output terminals

### IL430I

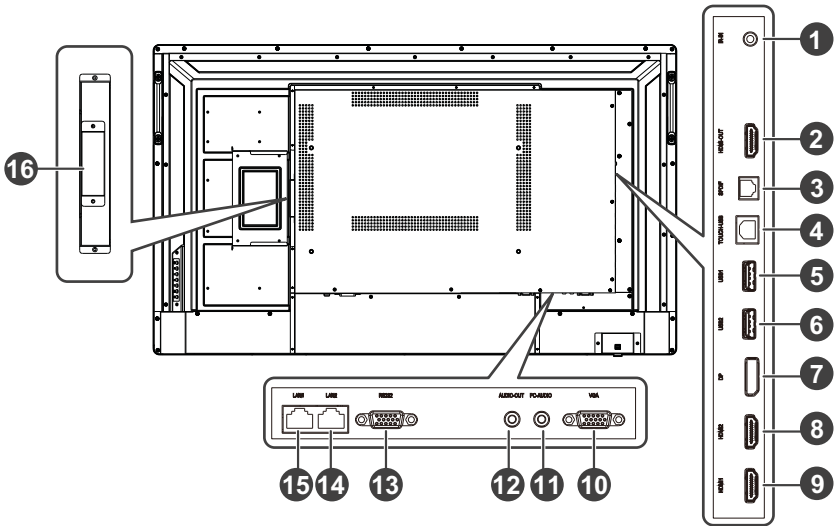



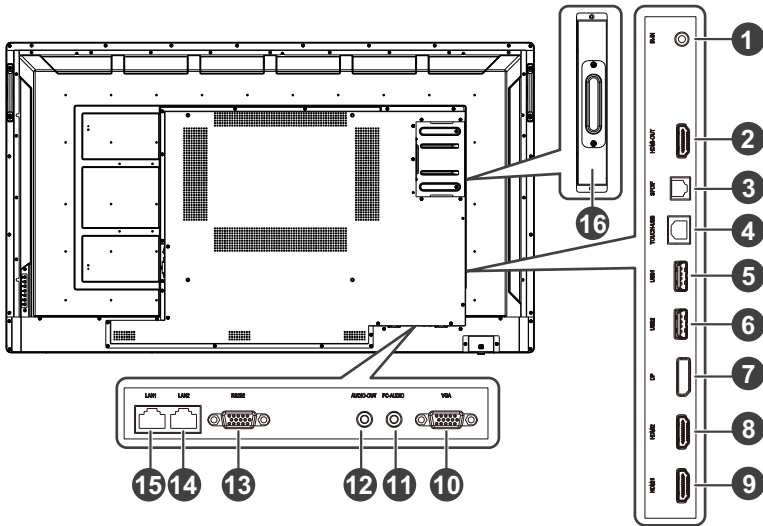

## IL5501



No.	Name	Description
1	IR-IN	Connects with an external IR receiver.
2	HDMI-OUT	Connects with a second display with an HDMI input through an HDMI cable to duplicate the images.
3	SPDIF	Connects with an external audio device through the SPDIF cable for audio out.
4	TOUCH-USB	Supports touch signal input from an external computer. When connecting the external computer, besides connecting the external computer's video and audio signals via their respective ports, the external computer's USB port needs to be connected to the corresponding touch port. Once the driver is installed, the external computer can be controlled via touch gestures on the display (the touch function is enabled for the VGA and HDMI channels by default).
5	USB1	Connects with USB devices such as keyboards, point devices, or flash drives.
6	USB2	Connects with USB devices such as keyboards, point devices, or flash drives.
7	DP	Connects with devices transmitting audio/video using the DisplayPort interface.
8	HDMI2	Connects with devices transmitting audio/video using the HDMI interface.
9	HDMI1	Connects with devices transmitting audio/video using the HDMI interface.
10	VGA	Connects with devices transmitting video using the VGA interface.

No.	Name	Description
11	PC-AUDIO	Connects with the VGA video source (via a 3.5mm cable) to receive audio from the device.
12	AUDIO-OUT	Connects to external speakers or earphones.
13	RS232	Connects with the serial I/O connector of a device to transfer data.
14	LAN2	<ul style="list-style-type: none"> <li>Connects with a local network using a standard Ethernet cable.</li> <li>Supports 10/100 Mbps transmission speed.</li> </ul>
15	LAN1	<ul style="list-style-type: none"> <li>Connects with a local network using a standard Ethernet cable.</li> <li>Supports 10/100 Mbps transmission speed.</li> </ul>
16	OPS Slot	Supports installation of an OPS (Open Pluggable Specification) device.



- USB2.0= 5V  500mA / USB3.0= 5V  1.0A
- OPS= 18V  5A
-  : Direct Current / DC
-  : Alternating Current /AC
- The maximum length for the cables to be used with the USB slots are 5m (USB 2.0) and 3m (USB 3.0).
- The product is designed for IT power distribution system with phase-to-phase voltage 230V.

## Remote control

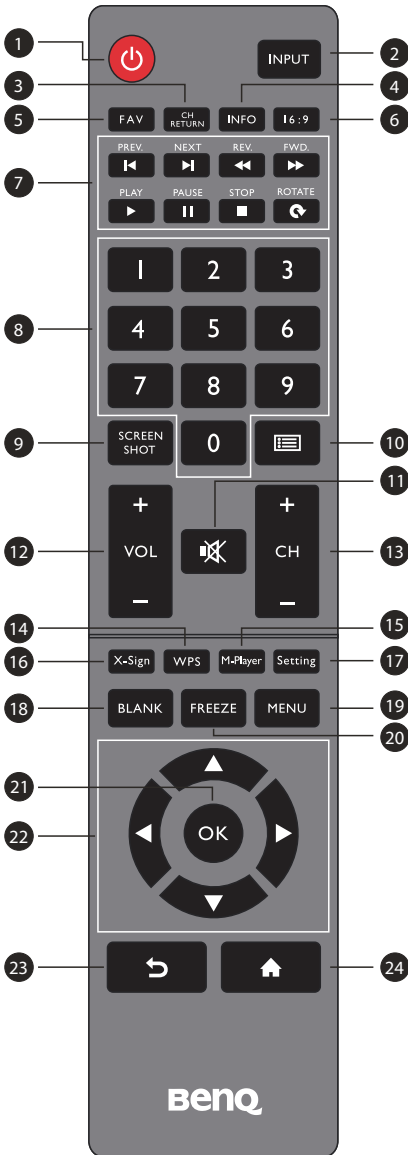

### 1 POWER

Turn the display on or off.

### 2 INPUT

Select the input source.

### 3 CH RETURN

Channel return

Note: It is only working on some specific regions.

### 4 INFO

Show the information of the current input source.

### 5 FAV

Favorite program

Note: It is only working on some specific regions.

### 6 Meeting mode

Change the display image to the different mode under non-Android system Mode: Full, 4:3, Film, Subtitle, PC mode.

### 7 MULTI-MEDIA buttons

The buttons are used to operate the media functions under Multi-Media APP.

### 8 Numeric buttons (0-9)

Press to enter numbers.

### 9 SCREEN SHOT

Capture the printed screen and save to the USB drive.

### 10 CHLIST (≡)

Delete a character / view program list.

Note: It is only working on some specific regions.

### 11 MUTE

Turn on/off the sound.

### 12 VOL- / VOL+

Turn up/down the volume.

### 13 CH+ / CH-

Change program channels.

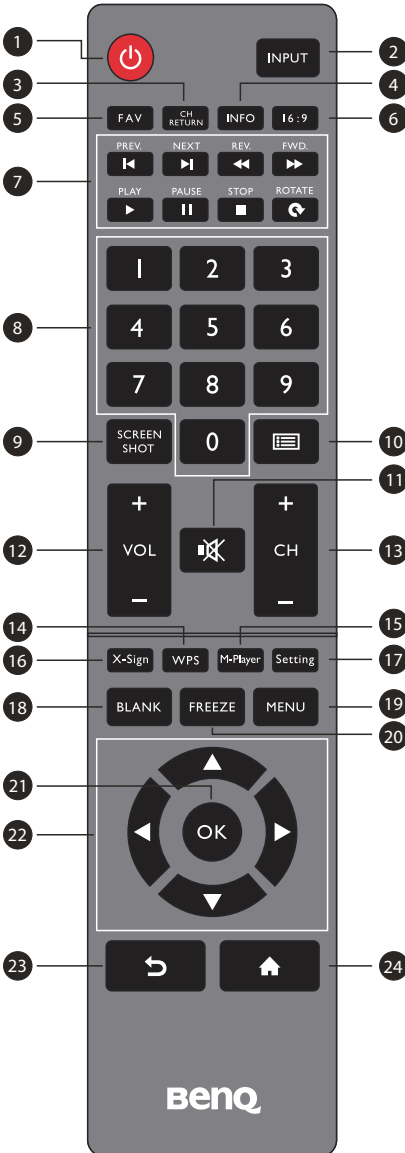

**14 WPS**

Open the WPS office app in Android

**15 M-Player**

Open the Media Player app in Android.

**16 X-Sign**

Open the X-Sign app in Android.

**17 Setting**

Open the setting function in Android.

**18 BLANK**

Blank and mute the screen (the screen will turn black) when the OSD menu is off. Press again to resume.

**19 MENU**

Activate the OSD menu.

**20 FREEZE**

Freeze the screen.

**21 OK**

Confirm the selected options or save changes.

**22 CURSOR KEYS (◀/▶/▲/▼)**

Scroll through settings and options in the OSD menu.

**23 BACK (↶)**

Press this key to return to previous page.

**24 HOME (🏠)**

Show the main screen of Android system.

## Using the remote control

### Installing remote control batteries

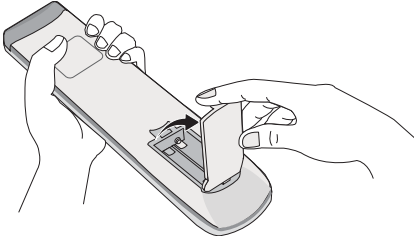

1. Open the remote control battery compartment cover.

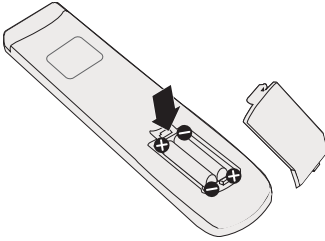

2. Insert the supplied batteries ensuring that the positive and negative marked battery terminals match the (+) and (-) marks in the battery compartment.



The supplied batteries are provided for your convenience so that you can operate the display straight away. You should replace them as soon as possible.

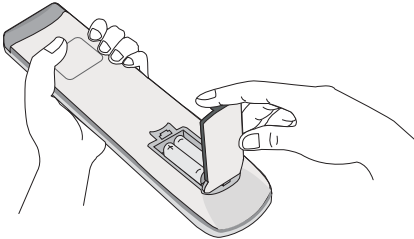

3. Refit the battery compartment cover.

## Remote control usage tips

- For better access to the IR sensor from the front, you can pull down the IR sensor from the rear at the bottom-left side by pulling the latch for the IR sensor. Not pulling down the IR sensor due to cosmetic purposes will not affect the performance of the IR sensor.
- When using the remote control, aim the remote control at the sensor at the display's bottom-left side within a distance of less than 5m, and a horizontal and vertical angle of less than 30 degrees.
- Do not let the remote control become wet or place it in humid environments (like bathrooms).
- If the display's remote control sensor window is exposed to direct sunlight or strong light, the remote control may not operate properly. In this situation, change the light source, readjust the angle of the display, or operate the remote control from a location closer to display's remote control sensor window.

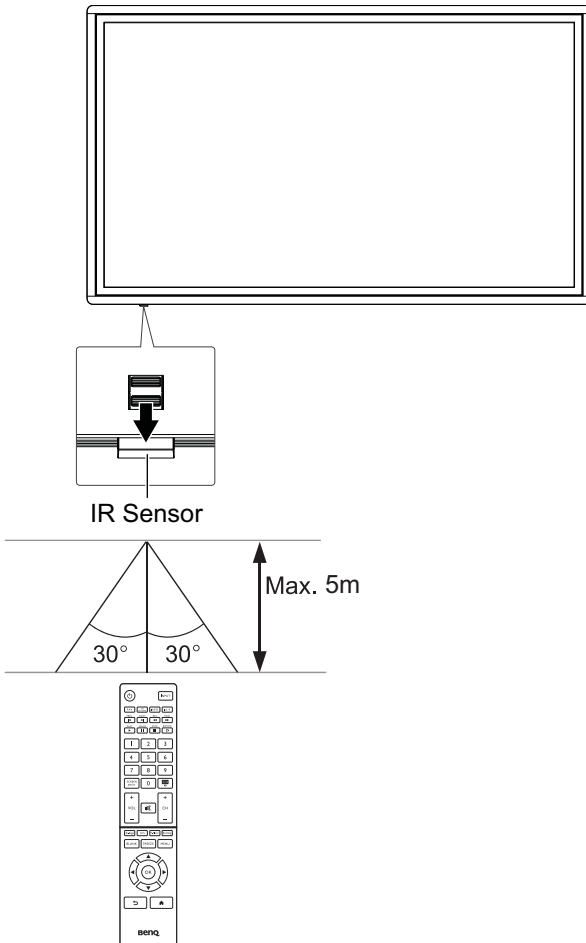



## Connection

### Connecting the VGA input

1. Connect the **VGA** jack on the display to the VGA output jack on a computer using a D-Sub (15-pin) cable.
2. Connect the computer's audio output jack to the **PC-AUDIO** jack on the display with a suitable audio cable.
3. Press **INPUT** on the remote control and then select **VGA** from the input source menu.

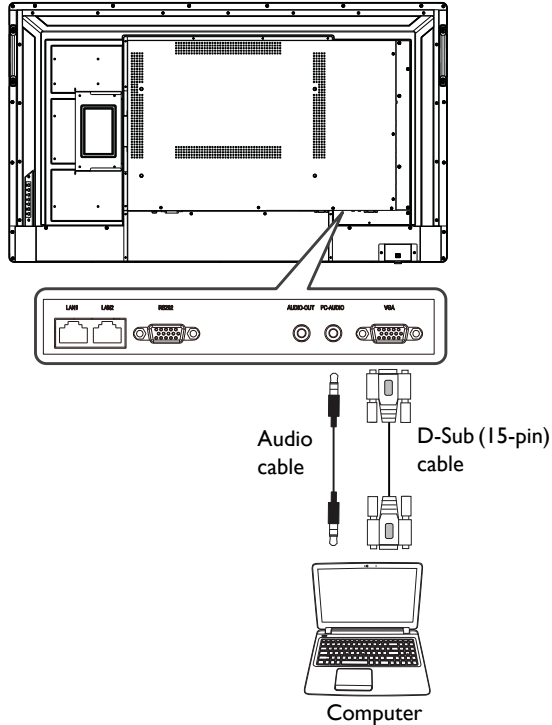

## Connecting the digital inputs

To use the HDMI interface:

1. Connect the **HDMI1** or **HDMI2** jack on the display to the HDMI output jack on a computer or external A/V device using an HDMI cable.
2. Press **INPUT** on the remote control and then select **HDMI1** or **HDMI2** from the input source menu.

To use the DP interface:

1. Connect the **DP** jack on the display to the DP output jack on a computer or external A/V device using a DP cable.
2. Press **INPUT** on the remote control and then select **DP** from the input source menu.

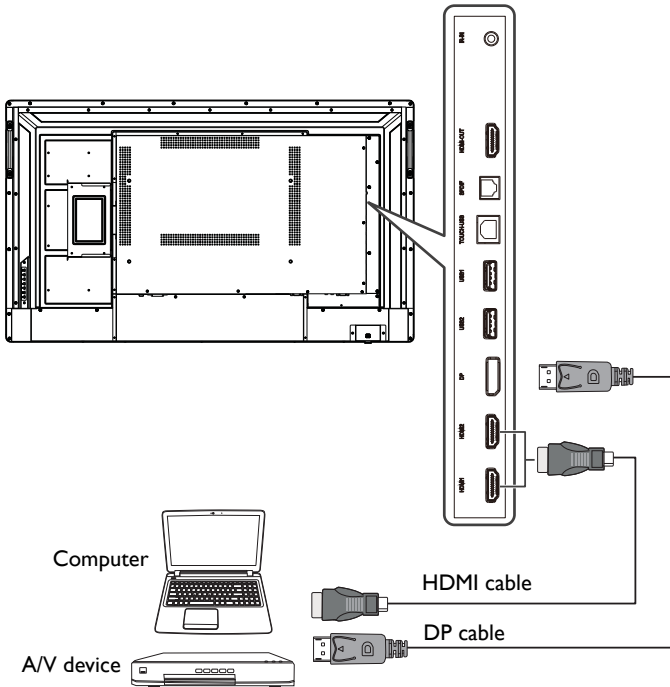

- The applicable cable is not supplied and should be purchased separately.
- The display provides a selection for the dual-monitor mode.

## Connecting the touch module

The touch module of the display supports easy Plug-and-Play operation. There is no need to install additional drivers on the computer.

1. Connect the **TOUCH-USB** port on the display to the USB port of a computer using the supplied USB cable and then connect the **VGA, HDMI1, HDMI2, or DP** port on the display to the VGA, HDMI or DP output port on the computer using the corresponding cables.
2. Press **INPUT** on the remote control and then select the interface through which the display is connected to a computer.

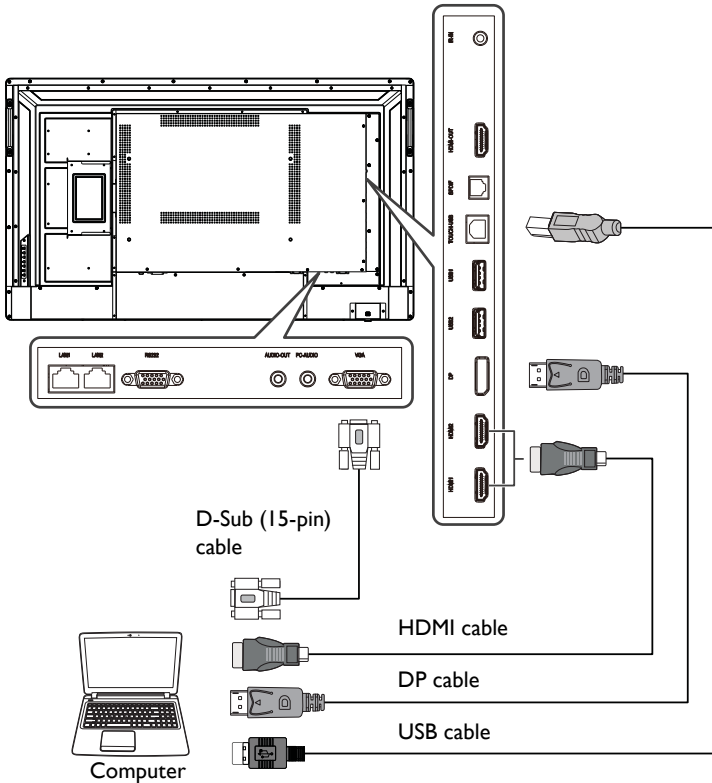

- Avoid blocking the touch screen frame (where sensors are located) when initiating the touch module.
- It is highly recommended that you connect the display to the PC or laptop directly. Avoid connecting the display to a face plate device which may cause failures in touch operations.
- If any ghost image occurs, please try to un-plug and then re-plug all USB cables. If the failure image still exists, use another USB type B to A cable.

## Connecting the video output

To connect with a second display to duplicate the video from the input source:

1. Connect the **HDMI-OUT** jack on the display to the HDMI jack of the second display using an HDMI cable.
2. Plug in power cord, and switch power on.
3. Press Power (⏻) on the remote control to turn on the display.

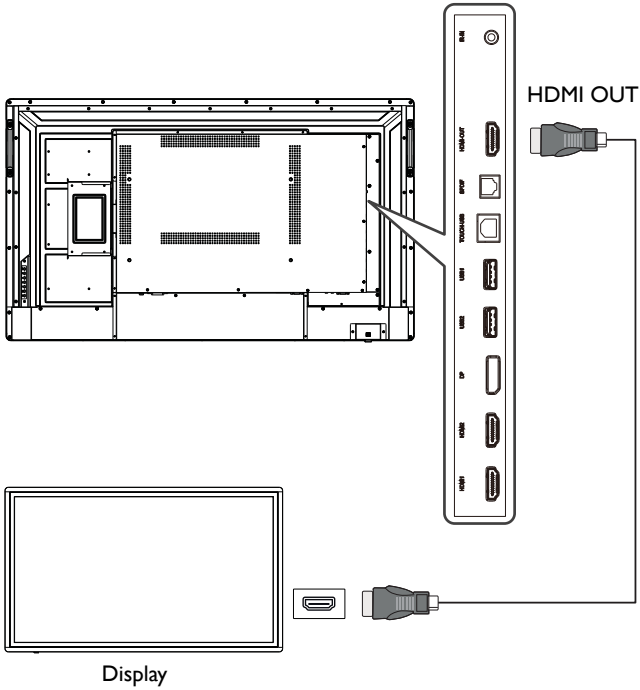

## Connecting to serial port

Connect the **RS232** jack on the display to the RS232 port on a computer through an RS232 cable.

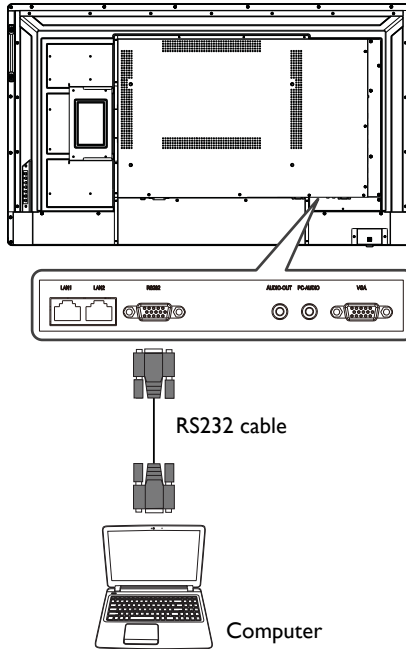

- The applicable cable is not supplied and should be purchased separately.
- This connection is applicable to straight-through RS232 cable only.
- After using serial port line to connect central control equipment and machine, certain function of the machine can be controlled via central control equipment, such as: machine on/off, and adjustment of sound volume, etc.

## Connecting power

Plug one end of the power cord into the AC IN port on the display and the other end into an appropriate power outlet (if the outlet is switched, turn on the switch).

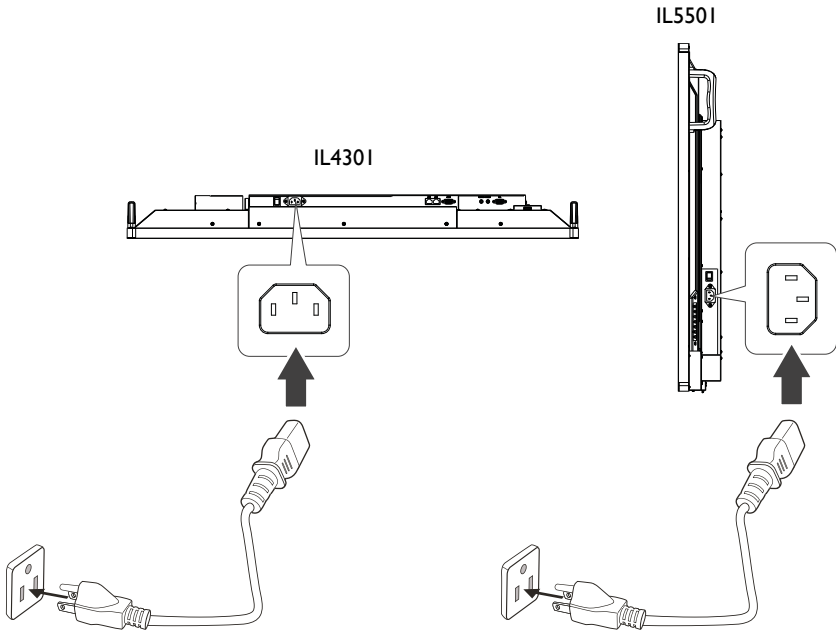

- The supplied power cord is suitable for use with 100-240V AC power only.
- The power cord and outlet illustrated may differ from the ones used in your region.
- Only use an appropriate power cord for your region. Never use a power cord which appears damaged or frayed, or change the plug type on the power cord.
- Be aware of the power loading when you use extension cords or multiple outlet power boards.
- There are no user serviceable parts in this display. Never unscrew or remove any covers. There are dangerous voltages inside the display. Turn off the power and unplug the power cord if you intend to move the display.
- The illustration is for your reference only.

## Basic operations

### Turning the display on or off

1. Be sure to follow the instruction of [Connecting power on page 26](#).
2. Before turning on the display, make sure the power switch is set to ON. The system will enter standby mode.

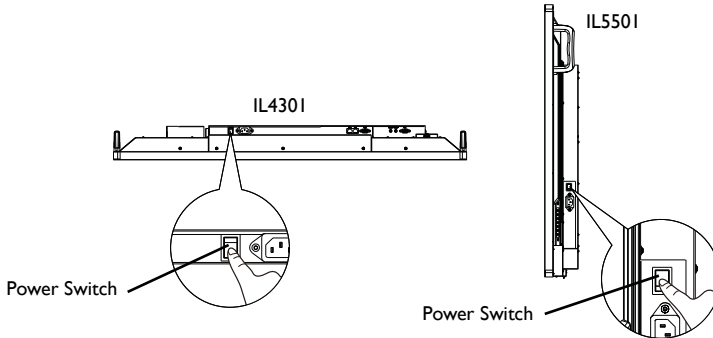

- For better access to the IR sensor from the front, you can pull down the IR sensor from the rear at the bottom-left side by pulling the latch for the IR sensor. Not pulling down the IR sensor due to cosmetic purposes will not affect the performance of the IR sensor.
- To turn on the display, press Power (⏻) on the rear panel or on the remote control.
- To turn off the display, press Power (⏻) on the rear panel or on the remote control. The system will automatically enter standby mode.

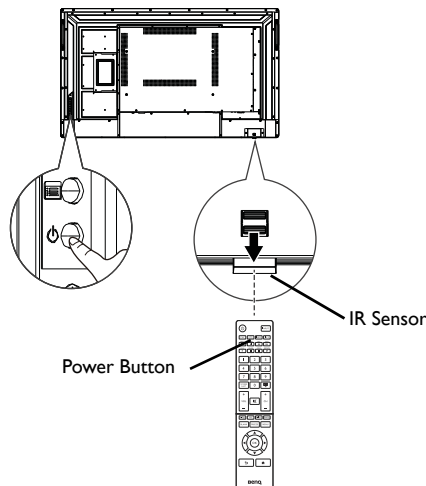

The display's standby mode still consumes power. To completely cut off power supply, set the power switch to OFF and then disconnect the power cord from the power outlet.

## Initial setup

After you have connected the display to the power, you are ready to power on the display. The first time you power on the display, you will be guided through a series of setup screens. Follow the on-screen instructions or the steps below to start up your display and complete the initial setup.

1. Turn on the display. Wait for the display to boot up with the BenQ screen. This may take a moment.
2. Tap **Next** on the screen to begin. Follow the on-screen instructions to set up the language, date and time, and network. Or you can skip some of these steps and complete the setup later.

## OSD Setting

Use one of the following methods to enter the OSD menu:

- Press **MENU** on the remote control.
- Press the menu button () on the rear panel.

Refer to [Menu operations on page 38](#) for more information.

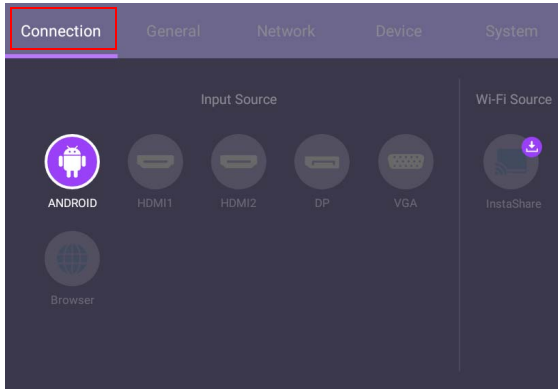

**InstaShare** is not preloaded. You need to download the app via **BenQ Suggests**. Refer to [BenQ Suggest on page 62](#) for more information.

## Switching input signals

To select an input signal, do either one of the following:

- Press **MENU** on the remote control.
- Press the menu button () on the rear panel.
- Select the desired input source in the **Connection** tab of the OSD menu. Refer to [Input settings on page 38](#) for more information.



## Downloading software

BenQ may periodically release software updates that may add functions or applications associated with your display. To check if there is a software update available for your device or to obtain the software license key, please visit <https://business-display.benq.com/en/findproduct/signage/software/partner-software/download.html>. Then enter the serial number (can be found on the sticker attached on the back of the display) and click **OK** to access the Software download page.

## Setting up the Internet connection

Your display must be connected to a network to conduct OTA updates or surf the Internet.



To find the MAC address in Android OS, please go to **Setting > System > About > Status**.

## Network setting

On the home screen, go to **Setting > System > About > Status**. If there is no IP address shown, please connect the display to the ethernet cable.

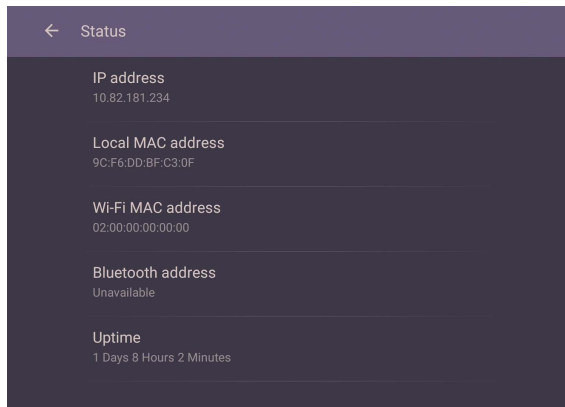

## Wireless connection

You must use a wireless adapter in order to connect the display to the Internet wirelessly. Please contact your local dealer for more information on configuring the wireless connection.

1. Press **MENU** on the remote control, or go to **Network > Wi-Fi**.

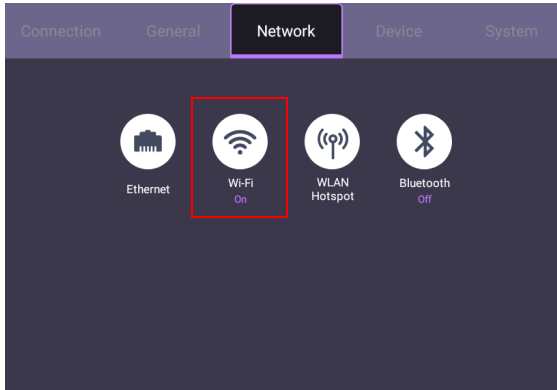

2. Insert the Wi-Fi dongle and the switcher will automatically switch to **ON**. A list of available networks will show on the screen.

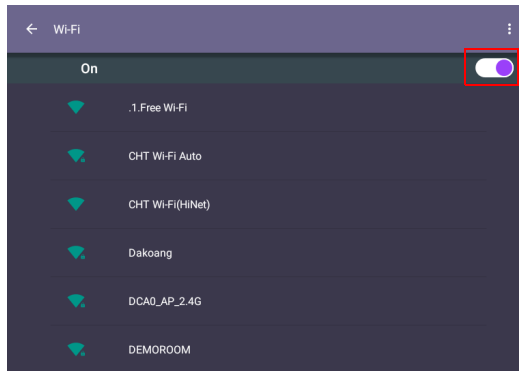

3. Touch the network's name to connect to the network. The password is needed if it is your first time to use the network. Key in the password and press **Connect**. The device is now connected to the WLAN.



- If you are connecting to a secured wireless network, enter the password for the wireless network access when prompted and tap **Connect**.
- For wireless connection, BenQ shipment does not include wireless dongles, therefore, you may purchase it separately via the local dealer.

## Updating software

Whenever a new version of software is available, the system will automatically detect the update and will prompt you to download it every time you turn on the display. If you want to update the software, choose **NETWORK UPDATE** or **USB UPDATE** to continue the update. Or you can skip this step and update the software later.

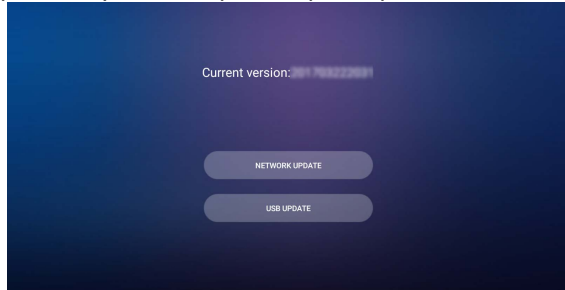

To manually update the software:

1. Go to **System > About**.

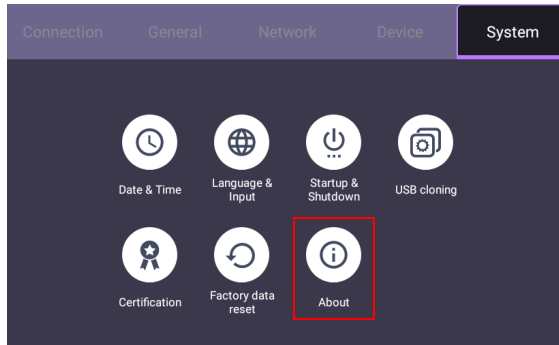

2. Select one of the following options to update the software:
  - If you want the system to search for the latest software and automatically start the update process, select **Update system**.
  - If you want to install the update software stored on a USB drive, select **USB update**.

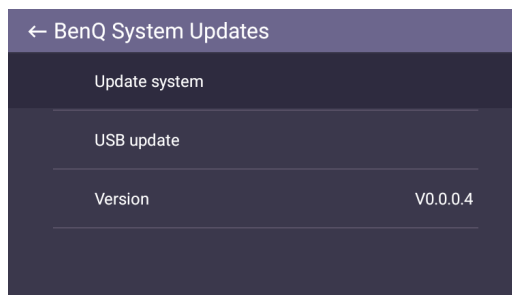

- Software update process may take some time to complete.
- During the update process, do not turn off the device or disconnect the Internet connection. Any interruptions during the software update process may permanently damage your display.

## Adjusting audio volume level

To adjust the audio volume level do either one of the following:

- Press **VOL-** / **VOL+** on the remote control to adjust the volume.
- Press ◀ / ▶ on the control panel of the display.
- Go to **Setting > General** to adjust the volume. Refer to [General settings on page 39](#) for more information.



## Using the touch screen

You can use the optical touch screen to control your operating system. The touch screen can emulate basic mouse functions and supports multi-touch functions for Windows 10/8/7/XP, Mac OS 10.11~10.14, Chrome OS 58, and Android. The following table shows a list of gestures you can use on the touch screen.



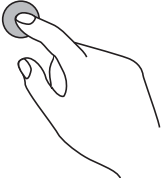
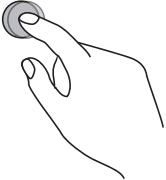
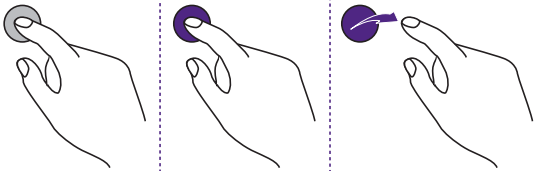
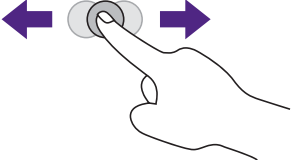

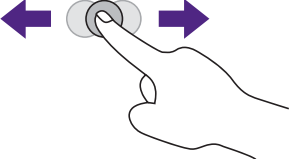
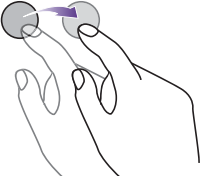

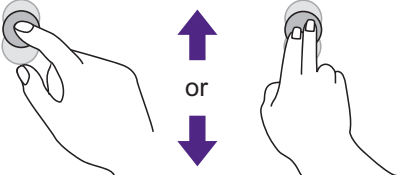
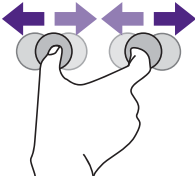
- Ensure that you have installed the USB cable on the display to a computer.
- Windows is a registered trademark of Microsoft Corporation in the United States and other countries.

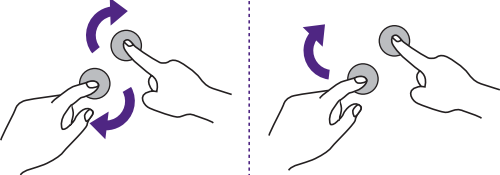
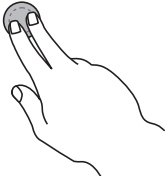
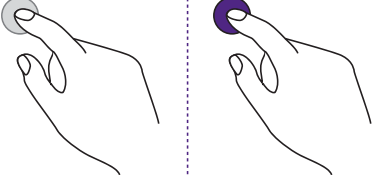
OS functions	Gesture actions
For Windows XP, Windows 7, Windows 8, and Windows 10	
Click	Tap the screen once. 
Double-click	Tap the screen twice. 
Right-click	<ol style="list-style-type: none"> <li>1. Press on the target.</li> <li>2. Hold and wait for a blue ring to appear.</li> <li>3. Release your finger.</li> </ol> 
Drag	Drag one finger left or right. 

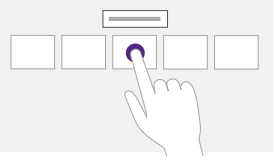
OS functions	Gesture actions
For Windows 7, Windows 8, and Windows 10	
Selection	<p>Drag one finger left or right.</p> 
Pan up / Pan down / Back / Forward	<p>Quickly drag your finger (Flick) in a desired direction.</p> 
<p>Multi-touch functions</p> <p>For Windows 7 - Home Premium, Professional, Enterprise and Ultimate versions</p>	
Right-click	<ol style="list-style-type: none"> <li>1. Press on the target.</li> <li>2. Tap the screen with another finger.</li> <li>3. Release the second finger.</li> </ol> 
Scrolling	<p>Drag one or two fingers up or down.</p> 
Zoom	<p>Move two fingers apart or toward each other.</p> 

OS functions	Gesture actions
Supported by specific applications	<ul style="list-style-type: none"> <li>• Move two fingers in opposing directions.</li> <li>• Use one finger to pivot around another.</li> </ul> 
Supported by specific applications	<p>Tap two fingers simultaneously. The target should be the midpoint between the fingers.</p> 
For Windows XP and Windows 7	
Wakeup from Windows sleep mode (S3)	<p>Press and hold for 4 seconds.</p> 

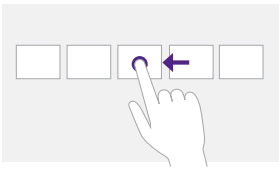
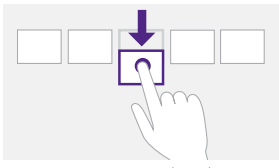
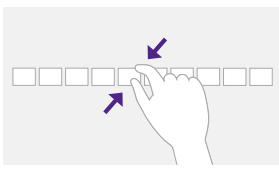
Gesture	Description
For Windows 8	
	<p>Press and hold to learn</p> <p>This touch interaction causes detailed information or teaching visuals (for example, a tooltip or context menu) to be displayed without a commitment to an action. Anything displayed this way should not prevent users from panning if they begin sliding their finger.</p>
	<p>Tap for primary action</p> <p>Tapping on an element invokes its primary action, for instance launching an application or executing a command.</p>

Gesture	Description
	<p><b>Slide to pan</b></p> <p>Slide is primarily used for panning interactions but can also be used for moving, drawing or writing. Slide can also be used to target small, densely packed elements by scrubbing (sliding the finger over related objects such as radio buttons).</p>
	<p><b>Swipe to select, command, and move</b></p> <p>Sliding the finger a short distance, perpendicular to the panning direction, selects objects in a list or grid (ListView and GridLayout controls). Display the AppBar with relevant commands when objects are selected.</p>
	<p><b>Pinch and stretch to zoom</b></p> <p>While the pinch and stretch gestures are commonly used for resizing, they also enable jumping to the beginning, end, or anywhere within content with Semantic Zoom. A SemanticZoom control provides a zoomed out view for showing groups of items and quick ways to dive back into them.</p>
	<p><b>Turn to rotate</b></p> <p>Rotating with two or more fingers causes an object to rotate.</p>



## Important instructions for using the touch screen

Please clean the frame when there is sign of malfunction on the touch screen.

- Before you clean the screen, make sure the display is turned off, and unplug the power cord.
- Remove dust or dirt from the screen and the infrared plastic filter periodically. It is suggested using a small amount of alcohol to clean the infrared plastic filter.
- To avoid damage to the screen, never use any type of abrasive materials to wipe the screen.
- Use a neutral detergent to clean the touch screen. Avoid using detergents with erosive substance, such as banana oil or ammonia.
- Moisten a clean soft, lint-free cloth with a neutral detergent and then clean the touch screen.
- Do not spray a detergent on the screen surface or the body directly. It may result in a short circuit to the touch screen.
- Keep the touch screen out of direct sunlight or spotlights.

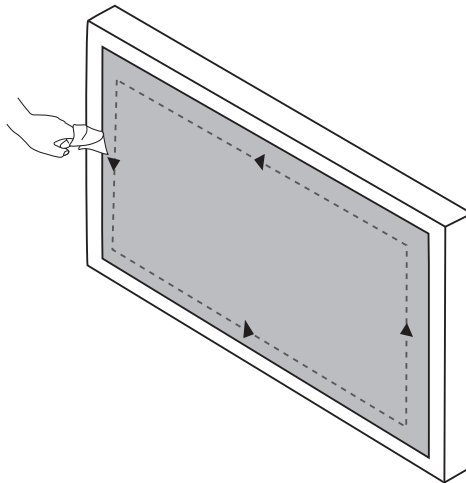



# Menu operations

## Settings menu

### Input settings

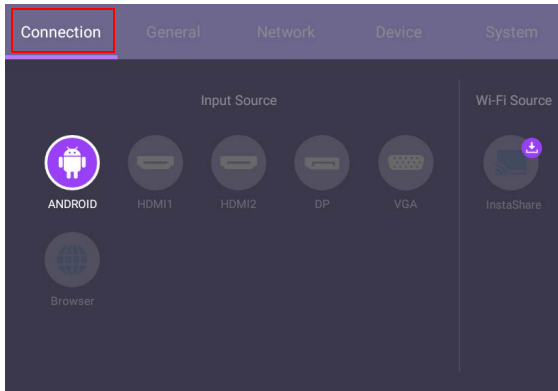
Press **MENU** on the remote control or the menu button (  ) on the rear panel to open the OSD menu.



- Press **▲** / **▼** / **◀** / **▶** on the remote control and press **OK** to confirm, or directly click a desired input source.
- Press  on the remote control or click a blank area outside the menu to exit the menu.

## General settings

Go to **General** to access the **Audio** and **Picture** settings.

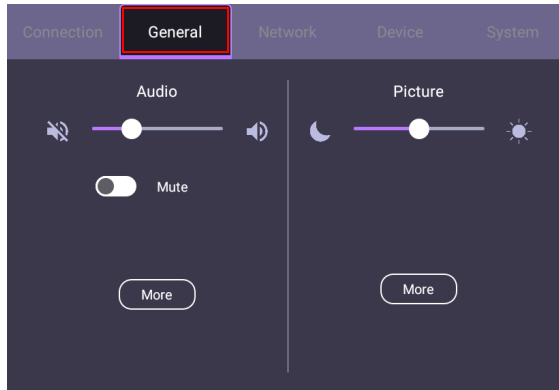

### Audio audio

- Use the volume bar to adjust the volume for the display.
- Swipe  to enable or disable **Mute**.
- Go to **More** to enter the **Audio** menu.

### Picture

- Use the brightness bar to adjust the brightness for the display.
- Go to **More** to enter the **Picture** menu.

## Audio settings

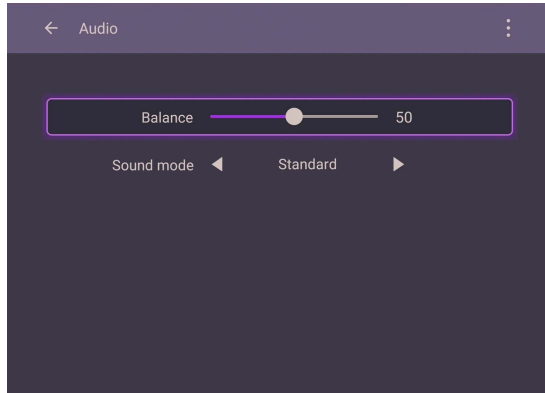

- Press **▲/▼/◀/▶** on the remote control and press **OK** to confirm or directly click an item.
- Press **↩** on the remote control or click a blank area outside the menu to exit the menu.

Menu	Description
<b>Balance</b>	Adjusts the sound balance of the audio output (0 to 100).
<b>Sound mode</b>	Switches between preset sound modes that best suit your environment ( <b>Standard / Movie / Class / Meeting / Custom</b> ).

## Picture settings

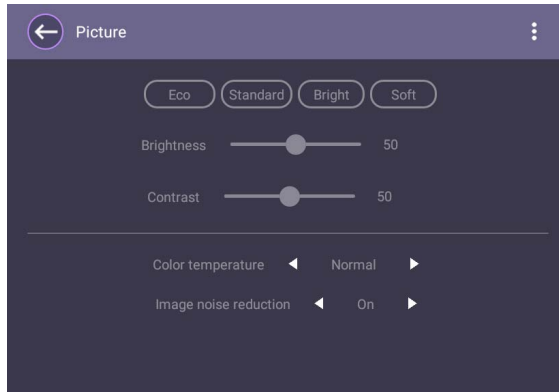

- Press **▲/▼/◀/▶** on the remote control and press **OK** to confirm or directly click an item.
- Press **➡** on the remote control or click a blank area outside the menu to exit the menu.

Menu	Description
<b>Picture Mode</b>	Switches between preset picture modes that best suit the type of images shown on the screen ( <b>Standard / Bright / Soft / Custom</b> ).
<b>Brightness</b>	Adjusts the brightness of the display (0 to 50).
<b>Contrast</b>	Adjusts the contrast of the display (0 to 50).
<b>Color temperature</b>	Adjusts the color temperature of the display ( <b>Cool / Normal / Warm</b> ).
<b>Image noise reduction</b>	Reduces image noise caused by different media players ( <b>On / Off</b> ).

## Device settings

Go to the **Device** page to access the **Device** settings.

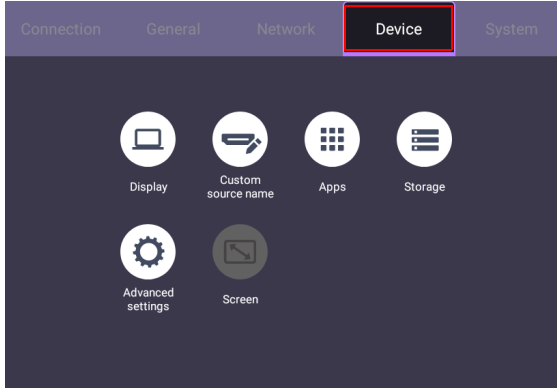

Menu	Description
<b>Display</b>	Allows you adjust the display's parameters. Refer to <a href="#">Display settings on page 43</a> for more information.
<b>Custom source name</b>	Allows you to set unique names for each input source.
<b>Apps</b>	Accesses all the applications installed in the display.
<b>Storage</b>	Allows you to manage the display's storage.
<b>Advanced settings</b>	Accesses more device settings. Refer to <a href="#">Advanced settings on page 44</a> for more information.
<b>Screen</b>	Allows you to adjust the display's image settings. Refer to <a href="#">Screen settings on page 45</a> for more information.

## Display settings

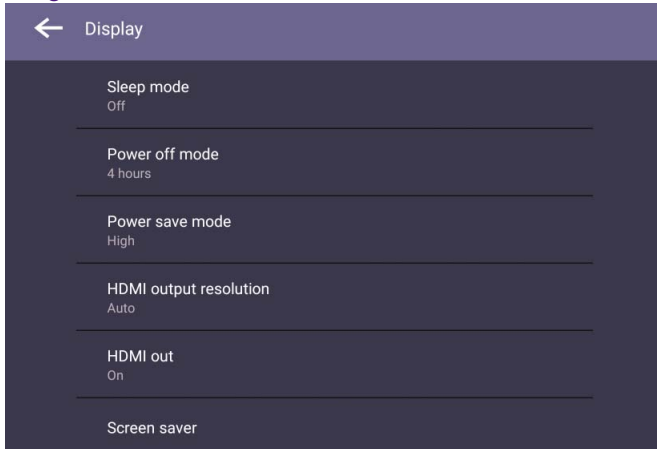

- Press **▲/▼/◀/▶** on the remote control and press **OK** to confirm or directly click an item.
- Press **⏪** on the remote control or click a blank area outside the menu to exit the menu.

Menu	Description
<b>Sleep mode</b>	Allows the display to automatically enter sleep mode after a specified period of time ( <b>Off</b> / 1 / 5 / 10 / 20 / 30 / 40 / 50 min / 1 / 2 / 3 / 4 hr).
<b>Power save mode</b>	Allows the display to enter power-saving mode when there is no signal detected ( <b>Off</b> / <b>Low</b> / <b>High</b> ).
<b>Power off mode</b>	Allows the display to automatically turn off after a specified period of time ( <b>Off</b> / 1 / 5 / 10 / 20 / 30 / 40 / 50 min / 1 / 2 / 3 / 4 hr).
<b>HDMI CEC</b>	Enables/Disables the HDMI CEC function.
<b>HDMI output resolution</b>	Configures the resolution of the HDMI output (1920 x 1080 / 3840 x 2160).
<b>HDMI out</b>	Enables/Disables the HDMI out function ( <b>On</b> / <b>Off</b> ).
<b>Orientation</b>	Sets the orientation of the display ( <b>Landscape</b> / <b>Portrait</b> ).
<b>Channel auto switch</b>	Allows the display to automatically detect the available input source ( <b>On</b> / <b>Off</b> / <b>Select</b> ).
<b>Change startup logo</b>	Allows you to set the boot-on logo of the display.
<b>Restore startup logo</b>	Allows you to restore the boot-on logo of the display.
<b>Change animation</b>	Allows you to set the boot-on animation of the display.
<b>Restore animation</b>	Allows you to restore the boot-on animation of the display.

### Advanced settings

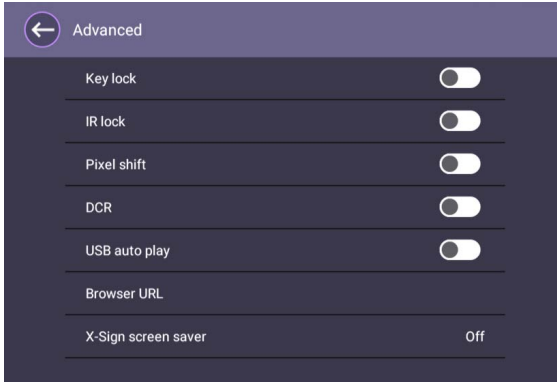

- Press ▲/▼/◀/▶ on the remote control and press **OK** to confirm or directly click an item.
- Press **↩** on the remote control or click a blank area outside the menu to exit the menu.

Menu	Description
<b>Key lock</b>	Locks/Unlocks the buttons on the rear panel of the display <b>(On / Off)</b> .
<b>IR lock</b>	Disables/Enables the IR sensor on the front panel of the display <b>(On / Off)</b> .
<b>Pixel shift</b>	Shifts the image shown on the screen to prevent image burn-in on the display <b>(On / Off)</b> .
<b>DCR</b>	Enables/Disables <b>DCR</b> (Dynamic Contrast Ratio) <b>(On / Off)</b> .
<b>USB auto play</b>	Allows the display to play the multimedia content stored on a USB flash drive connected to one of the display's USB ports <b>(On / Off)</b> . When <b>USB auto play</b> is enabled, a notification message will appear when you insert a USB flash drive into one of the display's USB ports. Select <b>Play Now</b> to play the multimedia content or <b>Cancel</b> to not play the content.
<b>Browse URL</b>	Allows you to input a URL to show that website as digital signage content. <div data-bbox="472 1204 871 1471" data-label="Image"> </div>



Menu	Description
<b>X-Sign screen saver</b>	Enables/Disables the X-Sign screen saver ( <b>On / Off</b> ).



- To unlock the IR sensor, press the following sequence of buttons on the remote control: **VOL+** > **▲** > **▶** > **▼** > **◀** .
- To unlock the keypad, press the following sequence of buttons on the remote control: **VOL+** > **▲** > **◀** > **▼** > **▶** .
- For image retention, please see [Notes on the LCD panel of this display on page 7](#) for more information.

## Screen settings

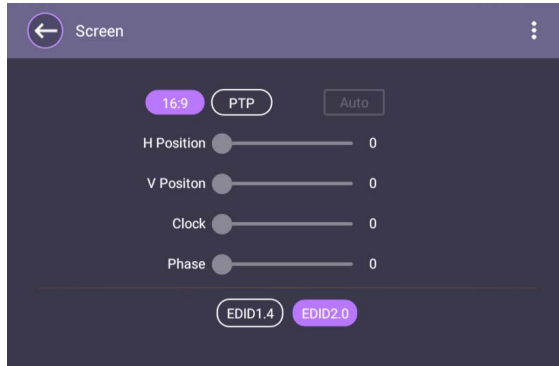

- Press **▲/▼/◀/▶** on the remote control and press **OK** to confirm or directly click an item.
- Press **⏪** on the remote control or click a blank area outside the menu to exit the menu.
- Press **◀/▶** on the remote control and press **OK** to adjust image.

Menu	Description
<b>Aspect Ratio</b>	Adjusts the aspect ratio of the display ( <b>16:9 / PTP / Auto</b> ).

- Use the **H Position**, **V Position**, **Clock**, and **Phase** functions to manually adjust the image.

Menu	Description
<b>H Position</b>	Adjusts the horizontal position of the video from the VGA input source (0 to 100).
<b>V Position</b>	Adjusts the vertical position of the video from the VGA input source (0 to 100).
<b>Clock</b>	Adjusts the width of the video from the VGA input source (0 to 100).
<b>Phase</b>	Adjusts the clarity of the video from the VGA input source (0 to 100).

## System settings

On the home screen, select **Setting > System** to enter system settings.

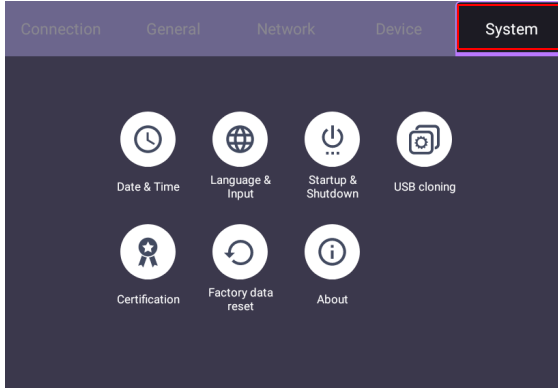

- Press  on the remote control or click a blank area outside the menu to exit the menu.

Options	Description
<b>Date &amp; time</b>	Sets the date and time for the display in the Android interface.
<b>Language &amp; Input</b>	Sets <b>Language, Keyboard &amp; Input methods</b> in the Android interface.
<b>Startup &amp; Shutdown</b>	Sets the <b>Startup channel, OPS Power option, Wake on active source, Wake on LAN, Close Power off reminder and Add task</b> . Refer to <a href="#">Startup &amp; Shutdown on page 49</a> for more information.
<b>USB cloning</b>	Allows you to import or export the display settings.  The exported display settings will be saved in db format and put under the path: /USB1/Settings.db
<b>Certificates</b>	Displays trusted credentials. It also allows you to install and delete credentials.
<b>Factory data reset</b>	Resets all custom settings on the display to factory settings.
<b>About</b>	Displays the system information for Android.

 The amount of available storage space for the user varies according to the amount of pre-installed apps and images occupying the total storage space.

## Proxy setting

1. Go to **Network > Ethernet**.

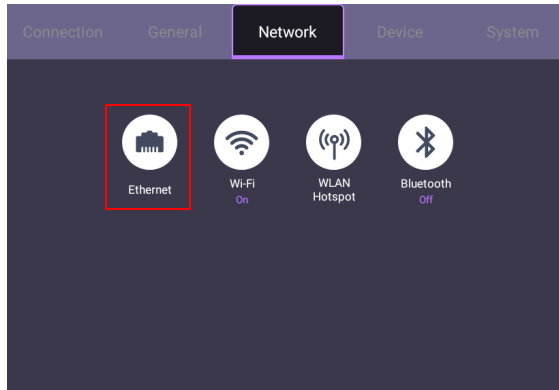

2. Press **Proxy** to go to the proxy setting.

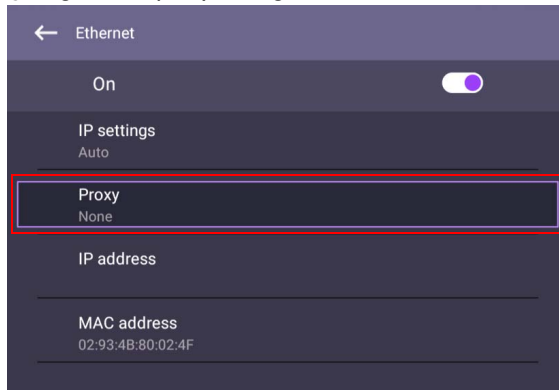

3. Select the one of the options based on your requirements:
  - **None**: Removes the proxy setting.

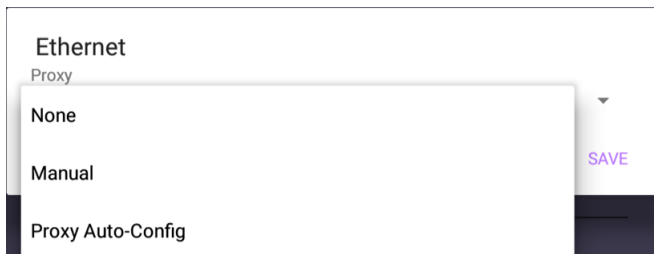

- **Manual:** Allows you manually configure all setting options for proxy.

Ethernet

Proxy

Manual ▼

Proxy Host name

proxy.example.com

Proxy Port

8080

Bypass proxy for

example.com,mycomp.test.com,localhost

CANCEL SAVE

- **Proxy Auto-Config:** Allows you to input PAC URL.

Ethernet

Proxy

Proxy Auto-Config ▼

PAC URL

https://www.example.com/proxy.pac

CANCEL SAVE

## Startup & Shutdown

- Go to **System > Startup & Shutdown**.

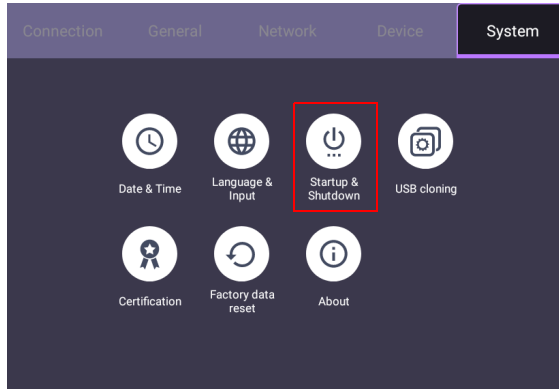

- For **Startup source**, you can choose **Last channel** or other sources.

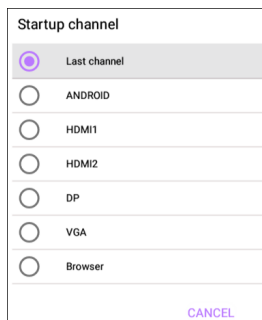
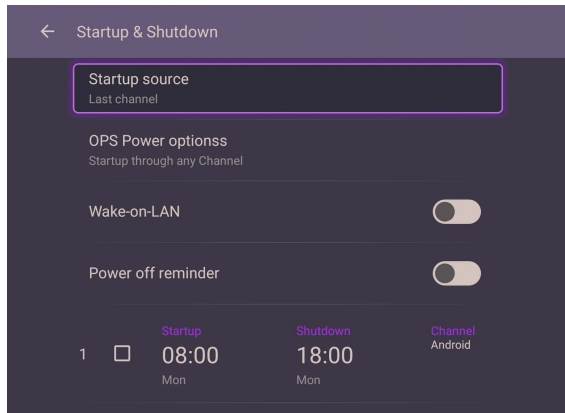

- For **OPS Power option**, you can choose **Startup only through OPS startup option** or **Startup through any channel**.

OPS Power options

Startup Only through OPS Startup Option

Startup through any Channel

CANCEL

- For **Close Power off reminder**, you can set on or off time. Schedules can be made by choosing the days of the week.

← Startup & Shutdown

**Edit task 1**

Startup Channel Android ▾

Startup / Shutdown day

Sun **Mon** Tue Wed Thu Fri Sat

Startup		Shutdown	
07	17	07	17
08 : 00	18 : 00	08 : 00	18 : 00
09	01	09	01

CANCEL SAVE RESET



# Android system interface





Note that this is a closed Android operating system. The closed platform ensures the proper use of the display by preventing downloads and use of unauthorized apps.





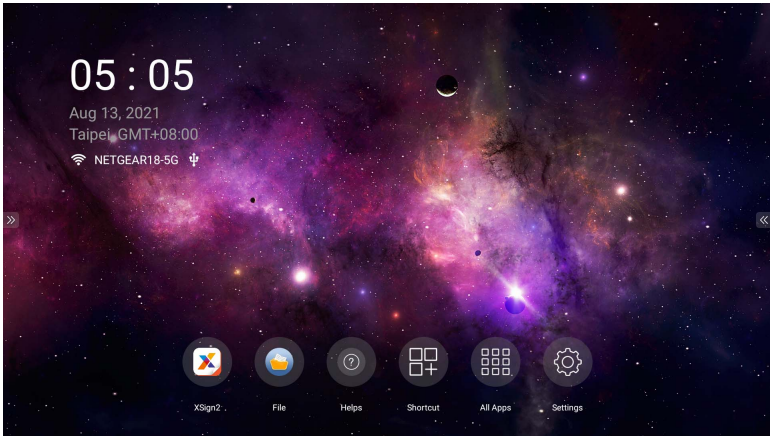

## Main screen

The display launches the Android main screen by default. To navigate to the Android main screen:

- Press  on the remote control to return to the main screen.
- Press the menu button () on the rear panel to open the OSD menu and then select **ANDROID** to open the Android main screen.





If **Startup source** is set to any video input sources via the **DP**, **HDMI1**, **HDMI2**, or **VGA** port, the Android main screen may not appear after the display is turned on. You can press  on the remote control to open the Android main screen. Alternatively, press menu button  on the rear panel to open the OSD menu and then select **ANDROID** to open the Android main screen.

Icon	Function	Description
	<b>X-Sign</b>	Serves as a digital content management system that provides multiple templates and remote scheduling through the Internet. Refer to <a href="#">X-Sign on page 54</a> for more information.
	<b>File</b>	Manages your photos, music, or video files. Refer to <a href="#">File on page 55</a> for more information.
	<b>Helps</b>	Allows you to search for the display's user manual. Refer to <a href="#">Helps on page 52</a> for more information.
	<b>Shortcut</b>	Allows you to add shortcut for apps.
	<b>All Apps</b>	Accesses all apps installed on the display. Refer to <a href="#">All Apps on page 53</a> for more information.
	<b>Settings</b>	Allows you to manage network and other device settings.

## Side tool bar

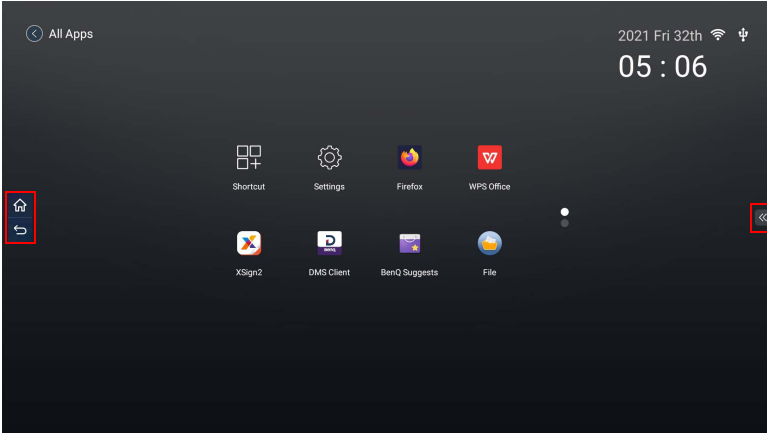
Tap the tabs at the left or right of the Android main interface to access the side tool bar.



Icon	Function	Description
	<b>Home</b>	Returns to the Android main screen.
	<b>Back</b>	Returns to the previous screen.

## Helps

**Helps** allows you to access the user manual of the display. When the **Helps** screen appears, scan the QR code to view the user manual.

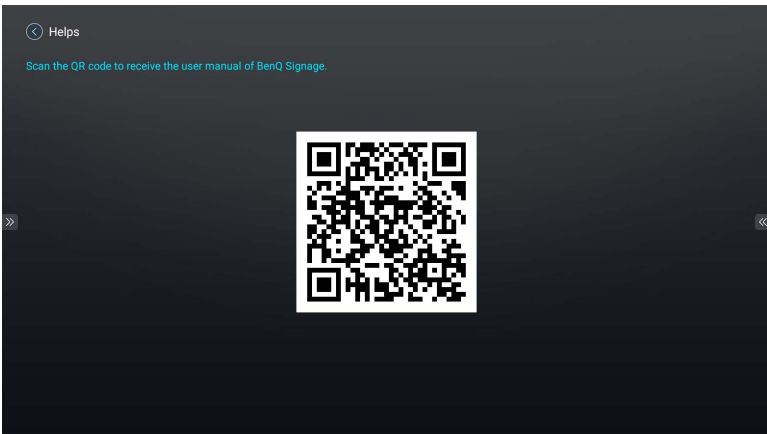







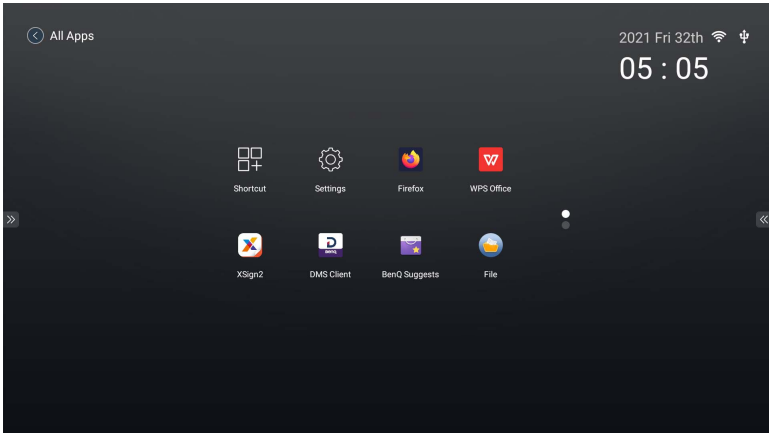







## All Apps

The display features various proprietary apps to create, manage, or play captivating digital signage content to instantaneously engage your customers.



Application Name	Description
<b>X-Sign</b> 	Serves as a digital signage content management system that provides multiple templates and remote scheduling through the Internet. Refer to <a href="#">X-Sign on page 54</a> for more information.
<b>File</b> 	Manages your photos, music, or video files. Refer to <a href="#">File on page 55</a> for more information.
<b>InstaShare</b> 	Allows screen mirroring and touch control for collaborative meetings. <b>InstaShare</b> is not pre-installed. You need to download <b>InstaShare</b> via <b>BenQ Suggest</b> . Refer to <a href="#">File on page 55</a> for more information.
<b>BenQ Suggest</b> 	Allows you to download recommended apps. Refer to <a href="#">BenQ Suggest on page 62</a> for more information.
<b>WPS Office</b> 	Allows you to read PDF files or edit files created in Microsoft Office, PowerPoint, or Excel. Refer to <a href="#">WPS Office on page 63</a> for more information.
<b>DMS Client</b> 	Allows remote management, configuration, and monitoring of the display.
<b>X-Sign Broadcast</b> 	Serves as a wireless broadcast system that allows immediate message delivery as well as group notification. <b>X-Sign Broadcast</b> is not pre-installed. You need to download it via <b>BenQ Suggest</b> . Refer to <a href="#">BenQ Suggest on page 62</a> for more information.

Application Name	Description
<b>TeamViewer Meeting</b> 	Gives you access to instant or scheduled group meetings with any other <b>TeamViewer Meeting</b> users.
<b>Firefox</b> 	Allows you to view websites.
<b>TeamViewer QuickSupport</b> 	Allows technicians to provide remote technical assistance.
<b>Settings</b> 	Allows you to manage network and other device settings.
<b>Shortcut</b> 	Allows you to set up shortcut for apps.

## X-Sign

**X-Sign** is a digital signage content creation app. Users can create content with X-Sign Designer on their PCs or laptops and then import the file to the display through the USB flash drive. The content will be played automatically.



X-Sign Designer can be downloaded from BenQ website. Please refer to the postcard in the accessory pack for the download instructions.

## File

**File** allows you to manage and play your photos, music, or video files.

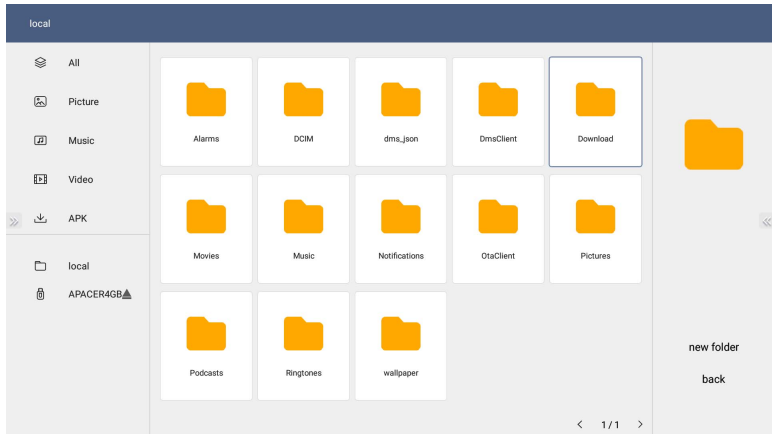









Function	Description
<b>All</b> (📁)	Lists all files.
<b>Picture</b> (🖼️)	Lists image files.
<b>Music</b> (🎵)	Lists audio files.
<b>Video</b> (🎬)	Lists video files.
<b>APK</b> (📄)	Lists app installation files.
<b>local</b> (📁)	Accesses the internal storage of the display.
<b>USB</b> (🔌)	Accesses USB drives inserted into one of the USB ports at the rear panel of the display.

Select the file you want to play and the media player will automatically launch. The following sections describe how to use the media player to play picture, music or video files on the display.

## Picture

Select an image file you want to show on the display and perform any of the functions shown on the screen.



Icon	Description
	Plays the previous image file.
	Plays/Pauses the current playback.
	Plays the next image file.
	Magnifies the current image.
	Shrinks the current image.
	Rotates the current image counter-clockwise.
	Rotates the current image clockwise.
	Displays file information.
	Sets the current image as wallpaper.

### Supported image format

Image	Resolution
JPEG	3840x2160
PNG	
BMP	







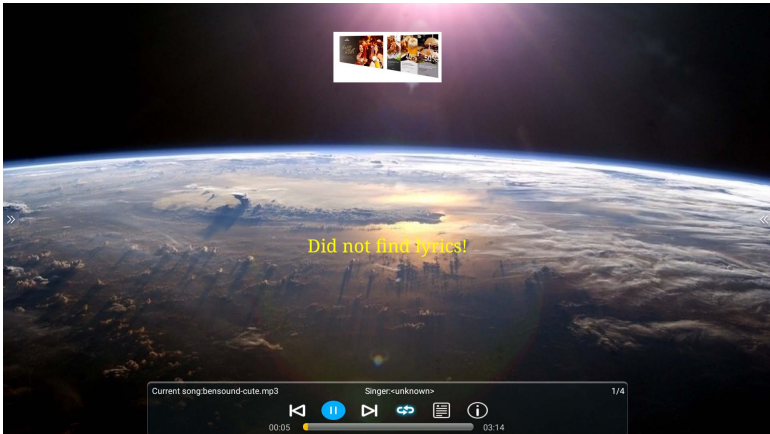

The limitation of maximum resolution depends on DRAM size.

## Music

Select an audio file you want to play and perform any of the functions shown on the screen.



Icon	Description
	Plays the previous audio file.
	Plays/Pauses the current audio file.
	Plays the next audio file.
	Sets the play sequence as play in order, repeat the current audio, or play randomly.
	Displays the content of the playlist.
	Displays file information.











## Supported audio format

Audio Codec	Sampling Rate	Bit Rate
MPEG 1/2/2.5 Layer 3	8 KHz - 48 KHz	8 Kbps - 320 Kbps
MPEG 1/2 Layer 1	16 KHz - 48 KHz	32 Kbps - 448 Kbps
MPEG 1/2 Layer 2	16 KHz - 48 KHz	8 Kbps - 384 Kbps
AAC, HEAAC	8 KHz - 48 KHz	AAC - LC: 12 Kbps - 576 Kbps

## Video

Select a video file you want to play on the display and perform any of the functions shown on the screen.



Icon	Description
	Plays the previous video file.
	Rewinds the video.
	Plays/Pauses the current video file.
	Fast forwards the video.
	Plays the next video file.
	Plays the next audio file.
	Displays the content of the playlist.
	Displays file information.
	Opens the setting menu and allows you to configure the play settings for the video file.
	Allows you to loop a specified part of the video.
	Adjusts the video volume.

**Supported video format**

Video Codec	Resolution	Bit Rate
MPEG 1/2	1080P @ 30 fps	30 Mbps
MPEG 4	1080P @ 30 fps	40 Mbps
H.263	1080P @ 30 fps	40 Mbps
H.264	4k2k @ 60 fps	135 Mbps
H.265	4k2k @ 60 fps	100 Mbps
VP8	1920 x 1080 @ 30 fps	50 Mbps

## InstaShare



**InstaShare** allows you to mirror the display's screen on your mobile device for hands-on annotation and mirror the screen of your mobile device on the display.

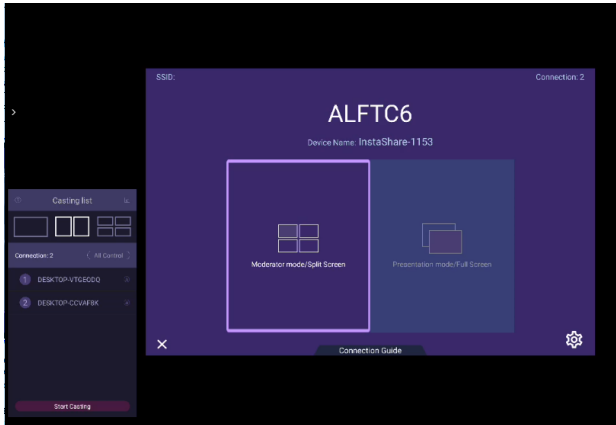

Before launching **InstaShare**, make sure your display is properly connected to Internet.



To use **InstaShare**:

1. Make sure your mobile device (such as smartphone or tablet) and the display are connected to the same network.
2. Download and install the **InstaShare** app on your mobile device.
3. Select  to launch **InstaShare** on your display.
4. Launch the **InstaShare** app on your mobile device, and then click the **InstaShare** ID name that you want to connect to or enter the pairing code.
5. Enter the connect code shown on the upper right corner of the display or you can also find the connect code in **Setting** ().
6. Once the mobile device has successfully connected to the display, a confirmation message will appear on the display. Select **Allow** on the display to confirm the connection.
7. Once connected you can:
  - Mirror the display's screen on your mobile device by tapping **Screen Mirroring** on your mobile device.
  - Mirror the device's screen on the display by tapping  on your mobile device.
  - Control the display by using your mobile device as a remote control.



Once connected, any operations on the display or mobile device will also show up on your mobile device and display.



You can also select **Setting** (⚙️) in the lower right corner of the display to modify the settings for **InstaShare**, such as the **InstaShare** ID name, connect code, or mirroring confirmation message.

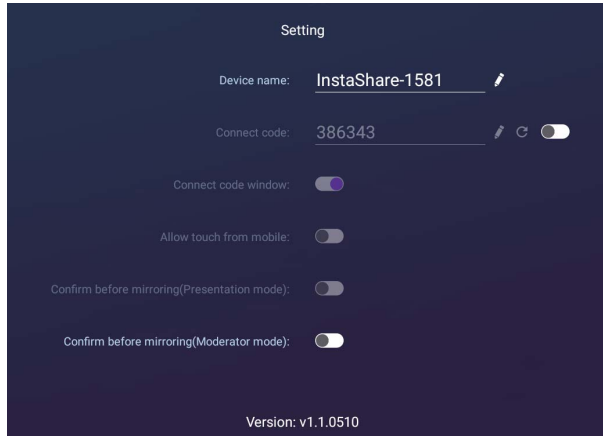

## BenQ Suggest

**BenQ Suggest** allows you to view and download recommended apps.

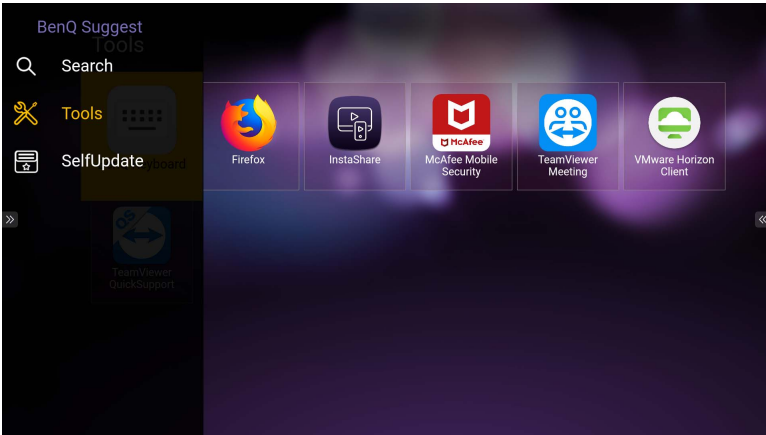

After **BenQ Suggest** is launched, you can select the category on the left panel to browse the suggested apps. Select an app from the selected category to view the basic description of the app.

Function	Description
<b>Search</b> (🔍)	Searches for an app.
<b>Tools</b> (✂️)	Lists the available apps.
<b>SelfUpdate</b> (📄)	Allows you to update the <b>BenQ Suggest</b> app.

## WPS Office

**WPS Office** allows you to read PDF files or edit files that are supported in Microsoft Office, PowerPoint, and Excel.

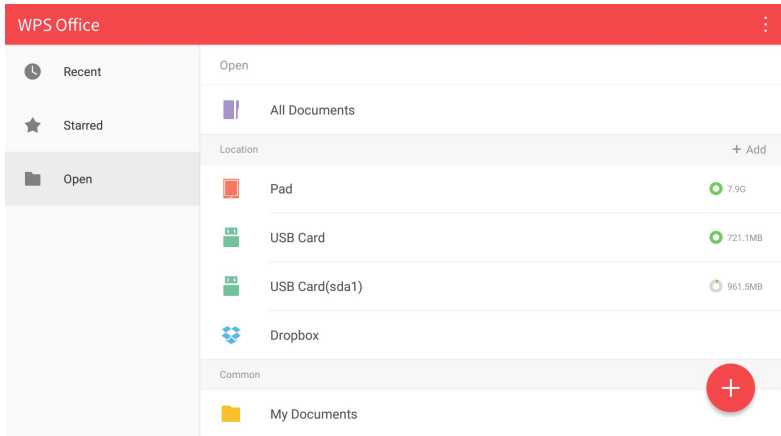

To edit a file with **WPS Office**:

Function	Description
<b>Open</b>	Allows you to browse and open a file.
<b>Share</b>	Allows you to share your files through email or other sharing applications.
<b>Manage</b>	Allows you to edit or manage the document.

1. Select **Open** (  ) on the left panel to browse and open a file located in either the display's internal memory, an external storage device, or cloud storage.
2. Select the function menu on the top panel to access the file format's various functions.



The description is for a PowerPoint file, the function menus for other file formats will vary.

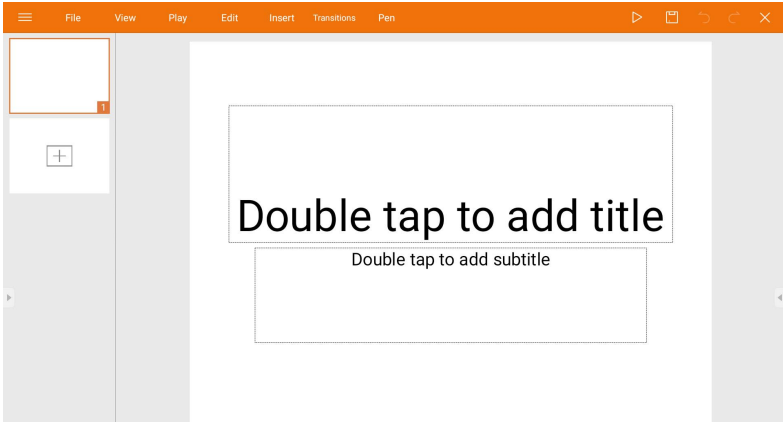

Function	Description
<b>File</b>	Allows you to open, save, share, print, and manage your presentations.
<b>View</b>	Allows you to change or edit the presentation views.
<b>Play</b>	Allows you to start or set up a slideshow.
<b>Edit</b>	Allows you to edit the content or format of the slides.
<b>Insert</b>	Allows you to insert tables, pictures, charts, comments, video, or audio.
<b>Transitions</b>	Allows you to apply or adjust the timing of a transition.
<b>Pen</b>	Allows you to write, draw, paint or sketch.
<b>Play (▷)</b>	Allows you to Select to start a slideshow.
<b>Save As (📁)</b>	Allows you to save the presentation file on either the display's internal memory, an external storage device, or cloud storage.
<b>Undo (↶)</b>	Allows you to undo an action.
<b>Redo (↷)</b>	Allows you to redo the last action.
<b>Close (✕)</b>	Allows you to close the presentation file.
<b>Back (←)</b>	Allows you to return to the previous page.
<b>Next (→)</b>	Allows you to go to the next page.
<b>Exit (⏏)</b>	Allows you to exit <b>WPS Office</b> .

## Supported Office versions and file formats

Supported Office versions: 97 / 2000 / XP / 2003 / 2007 / 2010

Supported Office software formats:

Office Software	Supported File Formats
<b>Word</b>	wps / wpt / doc / docx / dot / dotx / txt / log / irc / c / cpp / h / asm / s / java / asp / bat / bas / prg / cmd
<b>Excel</b>	et / ett / xls / xlsx / xlt / xltx / csv / xlsx / xltm
<b>PowerPoint</b>	ppt / pptx

# Product information

## Specifications

Item	Specifications	
	IL4301 / IL5501	
LCD panel	Light source	DLED
	Aspect Ratio	16:9
	Panel size	IL4301: 43" IL5501: 55"
	Frame Rate (Hz)	60
	Native resolution (pixels)	UHD 3840 x 2160
	Active Area (mm)	IL4301: 941.2 (H) x 529.4 (V) IL5501: 1209.6 (H) x 680.4 (V)
	Brightness (cd/m <sup>2</sup> ) (typical)	400
	Contrast ratio (typical)	IL4301: 1200:1 IL5501: 1300:1
	Pixel pitch (mm)	IL4301: 0.245 (H) x 0.245 (V) IL5501: 0.315 (H) x 0.315 (V)
	Response time (ms) (typ.)	IL4301: 8 IL5501: 9
	Panel Bit (8 or 10)	10 bit
Touch	Touch technology	Infrared Touch
	Touch resolution	32768 x 32768
	USB Touch Port	x 1 (USB type B)
Input	Video	VGA x1, HDMI x2 (2.0), DP x1 (1.2)
	Audio	PC Audio Input x1 (3.5mm)
	USB	Type-A USB (2.0) x2, Type-B USB (touch) x1
	Control	Yes
	OPS Slot	x1
Output	Audio	Line-out (3.5mm) x 1
	Video	HDMI x1 (2.0)
Audio	Audio W (Amp)	10W x2
	Internal speaker	O
Power	Supply	100 - 240V AC, 50/60 Hz IL4301: 2.5A IL5501: 2.5A
	Consumption (W) (typ.)	IL4301: 82W IL5501: 111W
	Consumption (standby)	0.5W

Environment	Operating Temperature	0°C - 40°C
	Operating Humidity	20% - 85% RH (non-condensing)
	Storage Temperature	-10°C - 60°C
	Storage Humidity	10% - 90% RH (non-condensing)
	Display Orientation	Landscape & Portrait
Mechanical	Weight (without packing / with packing) (kg)	IL4301: 18.8 / 24 IL5501: 29.1 / 35.2
	Bezel Width (T/B/L/R) (mm)	16.6 / 16.6 / 16.6 / 16.6
	Dimensions (W x H x D) (mm)	IL4301: 1011.0 x 599.2 x 97.4 IL5501: 1284.1 x 754.9 x 92.6
Feature	Image settings	○
	Sharpness enhancement	○
	10-bit color processing	○
	Source / volume control	○
	HDMI-HDCP	○
	DP-HDCP	○
	CEC control	○
	Firmware update	USB / OTA
RTC function	○	



Specifications and functions are subject to change without notice.

Item		IL4301 / IL5501
System	System Memory	3GB
	Storage	32GB
	OS	Android 8.0



- This Android 8.0 operating system is not standard Android, so access to Google Play™ is not available. APK cannot be installed in the default location unless given permission by the management units. Contact your BenQ dealer for the required support for management permission. Without management permission, installing function won't work. There is no guarantee that the self-installed APK can function normally.
- Current storage may vary by the product supplied for your region. Pre-installed system and apps may take up some space.

# Dimensions (IL430I)

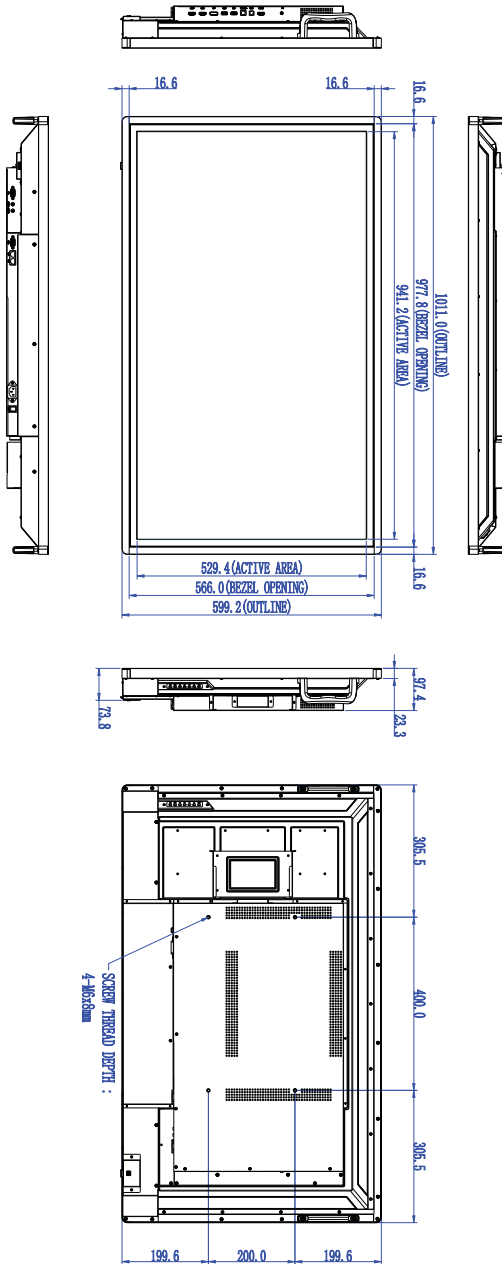

Unit: mm



# Dimensions (IL550I)

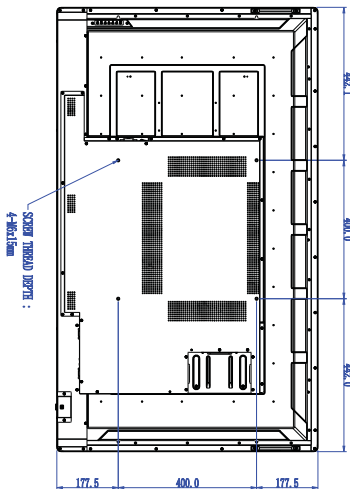
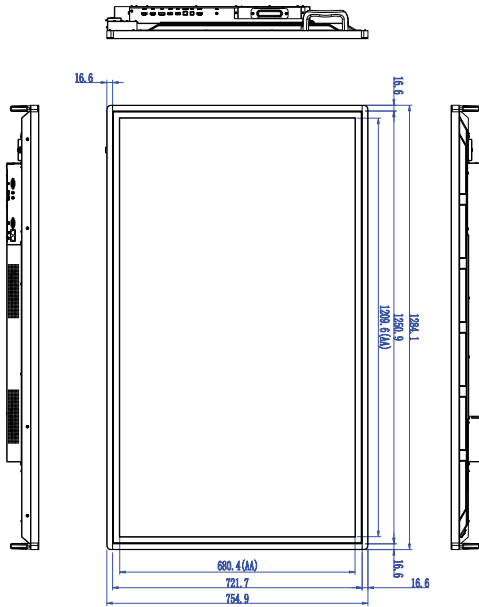

Unit: mm

## Supported input signal resolution

Resolution	Input source		
	VGA	HDMI 2.0	DP
640 x 480 @ 60Hz			
720 x 400 @ 70Hz			
800 x 600 @ 75Hz	○	○	○
1024 x 768 @ 60Hz			
1280 x 720 @ 60Hz	○	○	○
1280 x 960 @ 60Hz			
1360 x 768 @ 60Hz	○	○	○
1366 x 768 @ 60Hz	○	○	○
1600 x 900 @ 60Hz	○	○	○
1680 x 1050 @ 60Hz			
1920 x 1080 @ 30Hz	○	○	○
1920 x 1080 @ 50Hz	○	○	○
1920 x 1080 @ 60Hz	○	○	○
3840 x 2160 @ 30Hz		○	○
3840 x 2160 @ 50Hz		○	○
3840 x 2160 @ 60Hz		○	○
480i (60Hz)		○	○
480p (60Hz)		○	○
576i (50Hz)		○	○
576p (50Hz)		○	○
720p (50Hz)		○	○
720p (60Hz)		○	○
1080i (50Hz)		○	○
1080i (60Hz)		○	○
1080p (50Hz)		○	○
1080p (60Hz)		○	○



- ○: supported
- Vacant: not supported

# Troubleshooting

Problem	Solution
No picture	Check the following: <ul style="list-style-type: none"> <li>• Is the display turned on? Check the power indicator of the display.</li> <li>• Is the signal source device turned on? Turn on the device and try again.</li> <li>• Are there any loose cable connections? Make sure that all cables are connected firmly.</li> <li>• Have you chosen an unsupported output resolution on the computer?</li> <li>• Have you chosen an unsupported output resolution on the DVD or Blu-ray disc player?</li> </ul>
No sound	Check the following: <ul style="list-style-type: none"> <li>• Have you turned on the mute function on the display or the input source device? Turn off the mute function or increase the audio volume level and try again.</li> <li>• Are there any loose cable connections? Make sure that all cables are connected firmly.</li> </ul>
The computer input image looks strange	<ul style="list-style-type: none"> <li>• Have you chosen an unsupported output resolution on the computer?</li> <li>• Use the <b>Auto</b> function (VGA only) to let the display automatically optimize the display of computer image.</li> <li>• If the result of the <b>Auto</b> function is not satisfactory, use the <b>Phase</b>, <b>H Position</b> and <b>V Position</b> functions to manually adjust the image.</li> </ul>
The control panel buttons do not work	Have you locked the control panel buttons? Unlock the buttons and try again.
The remote control does not work	<ul style="list-style-type: none"> <li>• Have you locked the remote control function? Unlock the function and try again.</li> <li>• Check for incorrect battery orientation.</li> <li>• Check for dead batteries.</li> <li>• Check your distance and angle from the display.</li> <li>• Check whether remote control is properly being pointed at the display's remote control sensor window.</li> <li>• Check for any obstacle between the remote control and the remote control sensor window.</li> <li>• Check that the remote control sensor window is not under strong fluorescent lighting, or in direct sunlight.</li> <li>• Check for any devices (computer or personal digital assistant, PDA) nearby that transmit infrared signals which may cause interference to signal transmission between the remote control and the display. Turn off the infrared function of these devices.</li> </ul>

Problem	Solution
Remote control failure	<ul style="list-style-type: none"> <li>• Check whether there are other objects between remote control and television remote control receiving window, thus leading to failure of remote control.</li> <li>• Check whether the battery electrode in the remote control is correct.</li> <li>• Check whether remote control needs to replace battery.</li> </ul>
Machine automatically shutdown	<ul style="list-style-type: none"> <li>• Whether set sleep or not.</li> <li>• Check whether there is sudden power outage.</li> <li>• Check whether there is no signal automatic shutdown.</li> </ul>
Signal out of range	<ul style="list-style-type: none"> <li>• Check whether display is set correctly.</li> <li>• Check whether resolution is the best resolution.</li> <li>• Adjust line and field synchronization in menu.</li> </ul>
Background has vertical lines or streaks	<ul style="list-style-type: none"> <li>• Select automatic correction in menu.</li> <li>• Adjust clock and phase position in menu.</li> </ul>
Image lack of color, color is incorrect	<ul style="list-style-type: none"> <li>• Check whether VGA is not well connected or has quality problem.</li> <li>• Adjust chromaticity and brightness or contrast in menu.</li> </ul>
Display format that is not supported.	<ul style="list-style-type: none"> <li>• Select automatic correction in menu.</li> <li>• Adjust clock and phase position in menu.</li> </ul>
Touch function invalid	<ul style="list-style-type: none"> <li>• Check whether touch driver is installed and started.</li> <li>• Check whether the size of article touched is comparable with finger.</li> </ul>
Touch positioning not correct	<ul style="list-style-type: none"> <li>• Check whether driver is properly installed and make correction.</li> <li>• Check whether touch pen is facing the screen.</li> </ul>
No picture and no sound	<ul style="list-style-type: none"> <li>• Check whether the machine is started state.</li> <li>• Check whether signal wire is well plugged, whether INPUT is corresponding to it.</li> <li>• If in internal computer mode, check whether internal computer is started.</li> </ul>
With horizontal or vertical stripes or image dithering	<ul style="list-style-type: none"> <li>• Check whether signal wire is well connected.</li> <li>• Check whether other electronic equipment or power tools are placed around the machine.</li> </ul>
No color, color is weak or image is weak	<ul style="list-style-type: none"> <li>• Adjust chromaticity and brightness or contrast in menu.</li> <li>• Check whether signal wire is well connected.</li> </ul>
With image but without sound	<ul style="list-style-type: none"> <li>• Check whether mute button is pressed for mute.</li> <li>• Press <b>VOL+ / VOL-</b> to adjust volume.</li> <li>• Check whether audio line is connected correctly.</li> </ul>
Only one speaker has sound	<ul style="list-style-type: none"> <li>• Adjust sound balance in menu.</li> <li>• Check whether computer sound control panel only sets up one sound channel.</li> <li>• Check whether audio line is connected correctly.</li> </ul>

---

Problem	Solution
VGA output without sound	Check whether connect external device with headphone cable.

## Accessibility Requirements for Rehabilitation Act of 1973, Section 508

BenQ's commitment to accessible products allows us to support government in making accessible technology choices. BenQ's displays are compliant with Section 508 guidelines by including the assistive features as below:

- BenQ's displays have colored "Power" indicators. Refer to the user manual for color definitions. While the display is in standby or sleep mode for wake-up function, it uses less than two watts of electricity.
- BenQ's displays have a variety of settings of pre-programmed flicker-free timing to make the screen shown on the display readily accessible. The default timing setting is automatically turned on every time the displays is powered up, and thus reduces the hassle of user intervention.
- BenQ's displays have options for brightness and contrast adjustments that text and images could be displayed differently to meet the demands of the visually impaired. Other similar adjustments are also available by using the On-Screen Display (OSD) controls on the products.
- BenQ's displays include user-selectable color controls, such as color temperature selections (IFP: 5500K, 9300K, 12000K, DS: 6500K, 9300K, 12000K), with a wide range of contrast levels.
- BenQ's multimedia displays usually have one or two speakers for audio performance which allow users (including hearing impaired) to interact with the computer systems connected. Speaker controls are typically located on the front-panel.
- Firmware of BenQ's displays contain unique product information that helps computer systems to identify BenQ products and activate their Plug-and-Play function when connected.
- All BenQ's displays are compatible with the PC99 standard. For example, connectors are color-coded to help users easily connecting products to computer systems correctly.
- Some models of BenQ's displays contain additional USB ports for connection to more devices such as a special headphone to assist the hearing impaired.
- All BenQ displays come with user manuals, which are available on the BenQ's web site ([www.BenQ.com](http://www.BenQ.com)). Other types of documents may be available upon requests.
- BenQ's customer service provides answers and assistance to all our customers through phone calls, facsimiles, e-mails, or web sites.