



Digital Projector User Manual

Warranty and Copyright information

Limited warranty

BenQ warrants this product against any defects in material and workmanship, under normal usage and storage.

Proof of purchase date will be required with any warranty claim. In the event this product is found to be defective within the warranty period, BenQ's only obligation and your exclusive remedy shall be replacement of any defective parts (labor included). To obtain warranty service, immediately notify the dealer from which you purchased the product of any defects.

Important: The above warranty shall be void if the customer fails to operate the product in accordance with BenQ's written instructions, especially the ambient humidity must be in-between 10% and 90%, temperature in-between 0°C and 35°C, altitude lower than 4920 feet, and avoiding to operate the projector in a dusty environment. This warranty gives you specific legal rights, and you may have other rights which vary from country to country.

For other information, please visit www.BenQ.com.

Copyright

Copyright © 2020 by BenQ Corporation. All rights reserved. No part of this publication may be reproduced, transmitted, transcribed, stored in a retrieval system or translated into any language or computer language, in any form or by any means, electronic, mechanical, magnetic, optical, chemical, manual or otherwise, without the prior written permission of BenQ Corporation.

Disclaimer

BenQ Corporation makes no representations or warranties, either expressed or implied, with respect to the contents hereof and specifically disclaims any warranties, merchantability or fitness for any particular purpose. Further, BenQ Corporation reserves the right to revise this publication and to make changes from time to time in the contents hereof without obligation to notify any person of such revision or changes.

*DLP, Digital Micromirror Device and DMD are trademarks of Texas Instruments. Others are copyrights of their respective companies or organizations.

Patents

Please go to <http://patmarking.benq.com/> for the details on BenQ projector patent coverage.

Table of Contents

| | |
|---|-----------|
| Warranty and Copyright information | 2 |
| Important safety instructions | 4 |
| Introduction | 7 |
| Shipping contents | 7 |
| Projector exterior view | 8 |
| Controls and functions..... | 9 |
| Positioning your projector | 11 |
| Choosing a location | 11 |
| Obtaining a preferred projected image size..... | 12 |
| Mounting the projector | 12 |
| Operation | 14 |
| Installing the USB wireless dongle | 14 |
| Starting up the projector | 14 |
| Shutting down the projector | 16 |
| Adjusting the projected image | 17 |
| Fine-tuning the image size and clarity | 17 |
| Correcting keystone | 17 |
| BenQ Launcher | 19 |
| The BenQ Launcher home page | 19 |
| Navigating the BenQ Launcher home page | 20 |
| Using Voice Assistant | 20 |
| Using BenQ Launcher Settings | 21 |
| Connection | 22 |
| Wireless Connections..... | 23 |
| Wireless Hotspot..... | 28 |
| Bluetooth Connections..... | 30 |
| USB Connections | 32 |
| Software update..... | 33 |
| Navigating the Settings | 34 |
| Using the Settings | 34 |
| General | 35 |
| Display | 37 |
| Preference | 42 |
| Other menus | 45 |
| Maintenance | 46 |
| Care of the projector | 46 |
| Light information | 46 |
| Troubleshooting | 52 |
| Specifications | 53 |
| Projector specifications | 53 |
| Dimensions | 54 |
| Timing chart..... | 55 |

Important safety instructions

Your projector is designed and tested to meet the latest standards for safety of information technology equipment. However, to ensure safe use of this product, it is important that you follow the instructions mentioned in this manual and marked on the product.

1. **Please read this manual before you operate your projector.** Save it for future reference.



2. **Do not look straight at the projector lens during operation.** The intense light beam may damage your eyes.



3. **Refer servicing to qualified service personnel.**

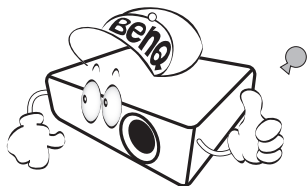

4. **Always open the lens shutter (if any) or remove the lens cap (if any) when the projector lamp is on.**

5. The lamp becomes extremely hot during operation. Allow the projector to cool for approximately 45 minutes prior to removing the lamp assembly for replacement.



6. In some countries, the line voltage is NOT stable. This projector is designed to operate safely within a mains voltage between 100 to 240 volts AC, but could fail if power cuts or surges of ± 10 volts occur. **In areas where the mains voltage may fluctuate or cut out, it is recommended that you connect your projector through a power stabilizer, surge protector or uninterruptible power supply (UPS).**



7. Do not block the projection lens with any objects when the projector is under operation as this could cause the objects to become heated and deformed or even cause a fire. To temporarily turn off the lamp, use the blank function.



8. Do not operate lamps beyond the rated lamp life. Excessive operation of lamps beyond the rated life could cause them to break on rare occasions.



9. Never replace the lamp assembly or any electronic components unless the projector is unplugged.



10. Do not place this product on an unstable cart, stand, or table. The product may fall, sustaining serious damage.

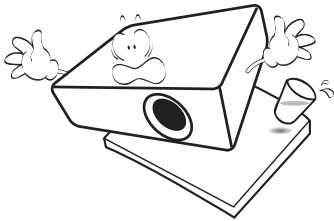

11. Do not attempt to disassemble this projector. There are dangerous high voltages inside which may cause death if you should come into contact with live parts. The only user serviceable part is the lamp which has its own removable cover.

Under no circumstances should you ever undo or remove any other covers. Refer servicing only to suitably qualified professional service personnel.



12. Do not block the ventilation holes.

- Do not place this projector on a blanket, bedding or any other soft surface.
- Do not cover this projector with a cloth or any other item.
- Do not place inflammables near the projector.

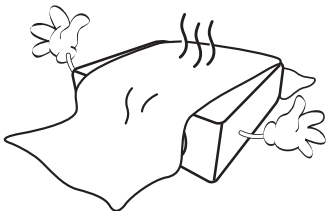

If the ventilation holes are seriously obstructed, overheating inside the projector may result in a fire.

13. Always place the projector on a level, horizontal surface during operation.

- Do not use if tilted at an angle of more than 10 degrees left to right, nor at angle of more than 15 degrees front to back. Using the projector when it is not fully horizontal may cause a malfunction of, or damage to, the lamp.

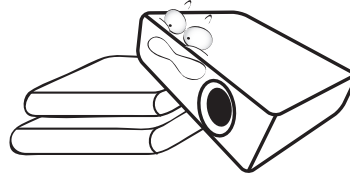

14. Do not stand the projector on end vertically. Doing so may cause the projector to fall over, causing injury or resulting in damage to the projector.

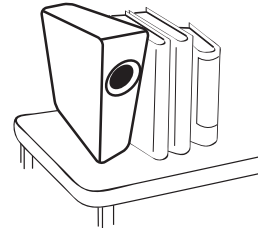

15. Do not step on the projector or place any objects upon it. Besides probable physical damage to the projector, doing so may result in accidents and possible injury.



16. When the projector is under operation, you may sense some heated air and odor from its ventilation grill. It is a normal phenomenon and not a product defect.

17. Do not place liquids near or on the projector. Liquids spilled into the projector may cause it to fail. If the projector does become wet, disconnect it from the power supply's power outlet and call BenQ to have the projector serviced.

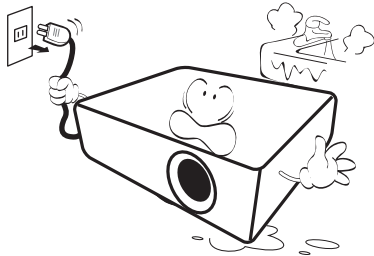

18. This product is capable of displaying inverted images for ceiling/wall mount installation.

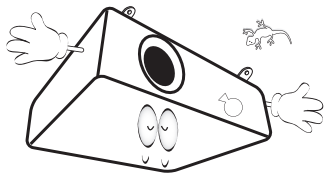

19. This apparatus must be earthed.



- Hg - Lamp contains mercury. Manage in accordance with local disposal laws. See www.lamprecycle.org.
- To avoid damaging the DLP chips, never aim a high-power laser beam into the projection lens.

20. Do not place this projector in any of the following environments.

- Space that is poorly ventilated or confined. Allow at least 50 cm clearance from walls and free flow of air around the projector.
- Locations where temperatures may become excessively high, such as the inside of a car with all windows rolled up.
- Locations where excessive humidity, dust, or cigarette smoke may contaminate optical components, shorten the projector's life span and darken the image.

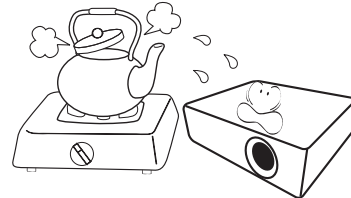

- Locations near fire alarms
- Locations with an ambient temperature above 40°C / 104°F
- Locations where the altitudes are higher than 3000 m (10000 feet).

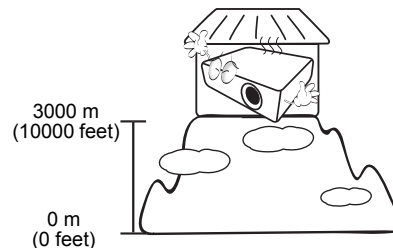

Introduction

Shipping contents

Carefully unpack and verify that you have all of the items shown below. If any of these items are missing, please contact your place of purchase.

Standard accessories

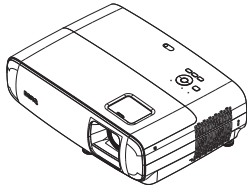

Projector

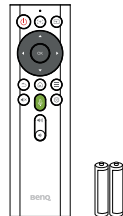

Remote control with batteries



User manual CD



Quick start guide and Warranty card*

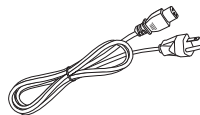

Power cord

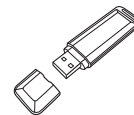

USB wireless dongle



• The supplied accessories will be suitable for your region, and may differ from those illustrated.

• *The warranty card is only supplied in some specific regions. Please consult your dealer for detailed information.

Optional accessories

1. Spare lamp kit

2. 3D glasses

Replacing the remote control batteries

1. Press and open the battery cover, as illustrated.
2. Remove the old batteries (if applicable) and install two AAA batteries. Make sure that the positive and negative ends are positioned correctly, as illustrated.
3. Replace the battery cover until it clicks into place.

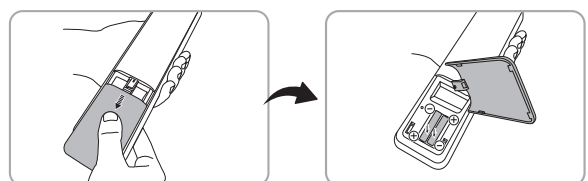

• Avoid leaving the remote control and batteries in an excessive heat or humid environment like the kitchen, bathroom, sauna, sunroom or in a closed car.

• Replace only with the same or equivalent type recommended by the battery manufacturer.

• Dispose of the used batteries according to the manufacturer's instructions and local environment regulations for your region.

• Never throw the batteries into a fire. There may be danger of an explosion.

• If the batteries are dead or if you will not be using the remote control for an extended period of time, remove the batteries to avoid damage to the remote control from possible battery leakage.

Projector exterior view

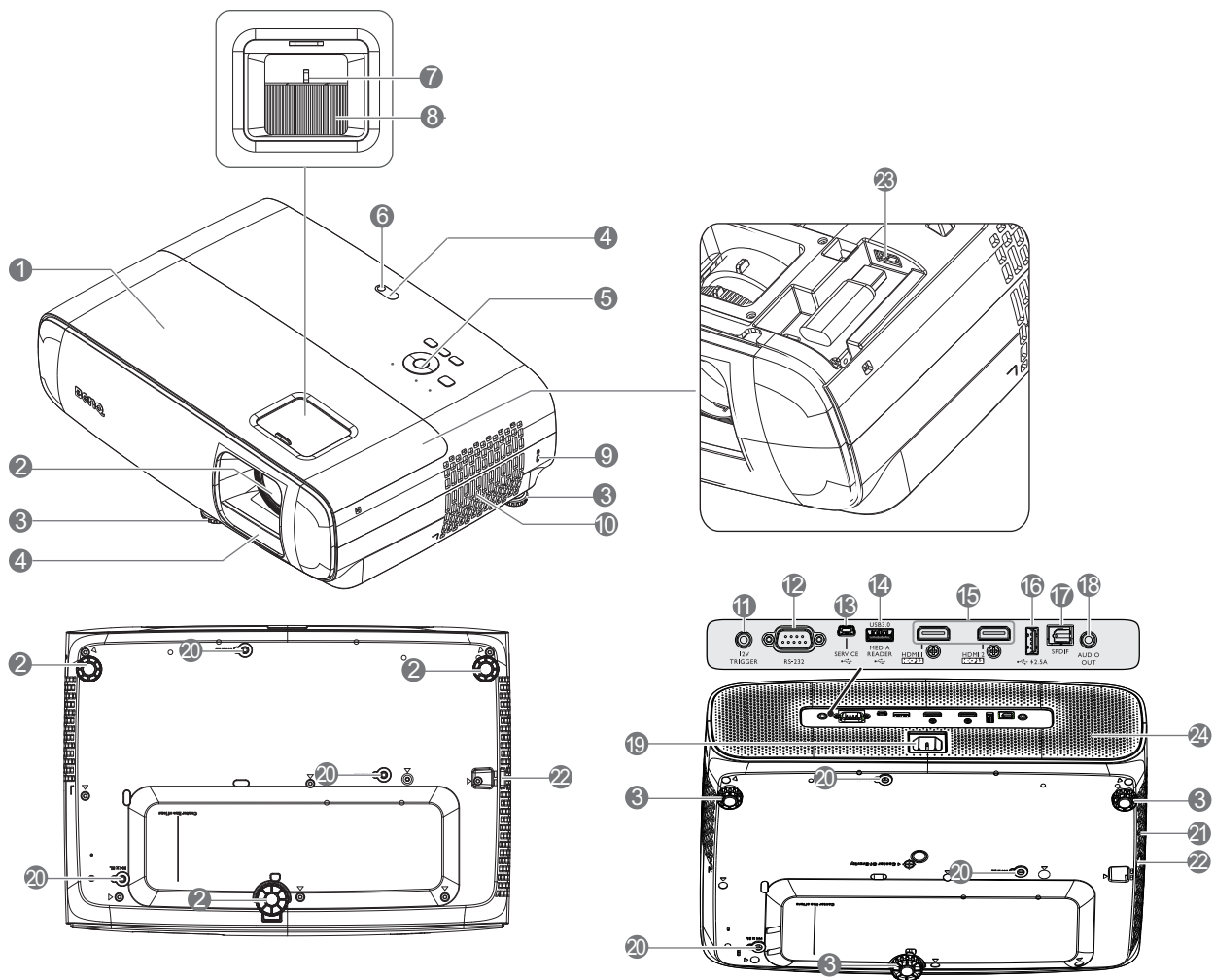

- 1. Lamp cover
- 2. Projection lens
- 3. Adjuster feet
- 4. IR remote sensor
- 5. External control panel
(See [Controls and functions on page 9.](#))
- 6. Light sensor
- 7. Zoom ring
- 8. Focus ring
- 9. Kensington anti-theft lock slot
- 10. Vent (air inlet)
- 11. 12V DC output terminal
Triggers external devices such as an electric screen or light control, etc.
- 12. RS-232 control port

- 13. USB Mini-B port (for firmware upgrades)
- 14. USB Type-A port (USB 3.0: 5V 1.5A media reader/drive, firmware download)
- 15. HDMI 1/ HDMI 2 input port (Version 2.0b)
- 16. USB Type-A port (USB 2.0: 2.5A power supply)
- 17. SPDIF output port
- 18. Audio output jack
- 19. AC power jack
- 20. Wall mount holes
- 21. Vent (air exhaust)
- 22. Security bar
- 23. USB Type-A port (USB wireless dongle)*
- 24. Speaker

* Located under the lamp cover. Before you plug into the dongle, remove the lamp cover and then install it back into position. Do not turn the power on with the lamp cover open.

Controls and functions

Projector & Remote control



All the key presses described in this document are available on the remote control or projector.

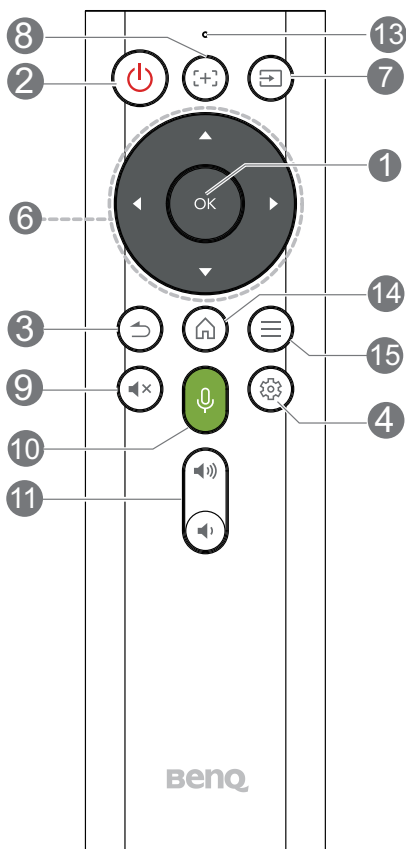
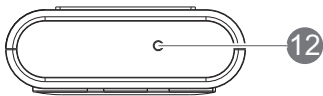
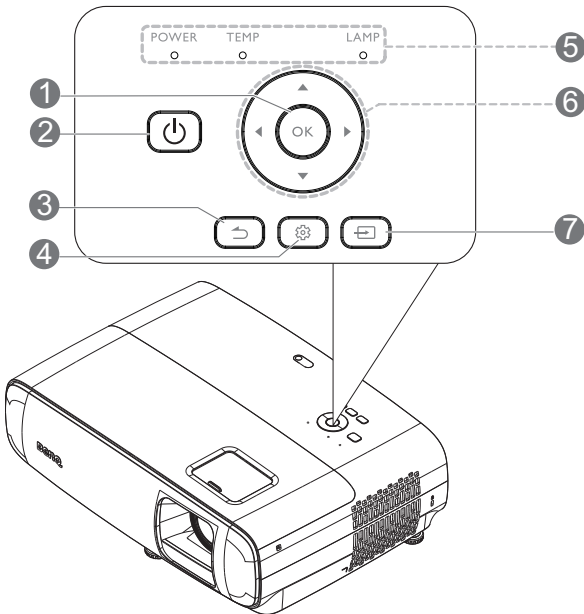

1. OK

Used to confirm the selection on the **BenQ Launcher** menu.

2. Power

Turns the projector off and on after initial startup.

3. Back

Used to return to the previous layer.

4. Settings

Enter **Settings** menu.

5. POWER indicator light/TEMPERature warning light/LAMP indicator light

(See [Indicators on page 51](#).)

6. Arrow keys (▲, ▼, ◀, ▶)*

When the On-Screen Display (OSD) menu is activated, these keys are used as directional arrows to select the desired menu items and to make adjustments.

7. Source*

Displays the source selection bar.

8. Cursor*

Pressing this key to enable or disable mouse cursor.

9. Mute*

Toggles projector audio between on and off.

10. Voice button*

Press and hold the voice button to activate voice assistant. Hold this key and speak to the microphone at the top of the remote control while using voice assistant.

11. Volume keys*

Decreases or increase the projector volume.

12. Microphone

Receives voice command.

13. LED Indicator

Flashes when the key is pressed or when doing Bluetooth Remote Control Pairing.

Press **Home** and **Menu** on the remote control at the same time for at least 3 seconds until the LED Indicator is flashing for pairing. If pairing is completed, then the LED Indicator will stop flashing.

14. **Home***

Press this key to enter the **BenQ Launcher** home menu.

15. **Menu***

Launches the Apps related settings when operating in All Apps.



- Do not block the projection lens from projecting as this could cause the blocking object to become heated and deformed or even cause a fire.

- Keys with "*" means that they are workable when the remote control is connected to **Bluetooth**.

Remote control effective range

The remote control must be held at an angle within with a range of 8 metres (~26 feet) at an angle of 30-degrees (left and right) and 20-degrees (up and down).

Make sure that there are no obstacles between the remote control and the IR sensor(s) on the projector that might obstruct the infra-red beam.

In a completely open environment, the distance of Bluetooth remote control will be within 5~7 meters. However, the remote control distance will be affected by the obstacles such as the wall or wireless signal.

- Operating the projector from the front

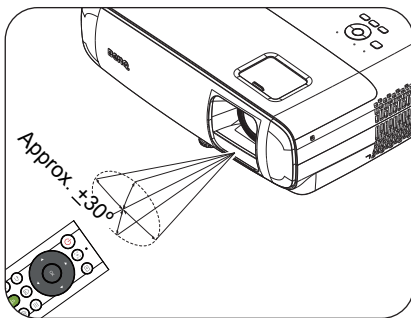

- Operating the projector from the top

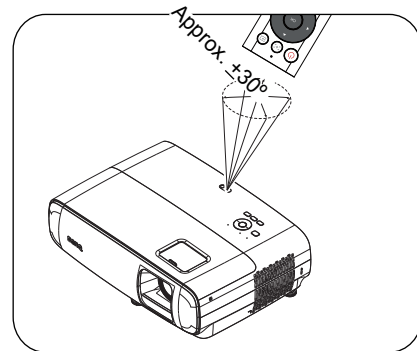

Remote Control Specifications

| | |
|-------------------|---------------------------|
| Wireless Protocol | Bluetooth Low Energy v4.2 |
| Power | AAA Battery * 2 |

Positioning your projector

Choosing a location

Before choosing an installation location for your projector, take the following factors into consideration:

- Size and position of your screen
- Electrical outlet location
- Location and distance between the projector and the rest of your equipment

You can install your projector in the following ways.

1. Front Table

Select this location with the projector placed on the table in front of the screen. This is the most common way to position the projector for quick setup and portability.

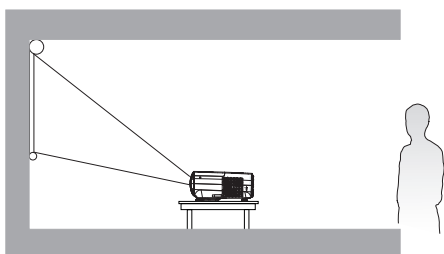

2. Rear Table

Select this location with the projector placed on the table behind the screen. Note that a special rear projection screen is required.

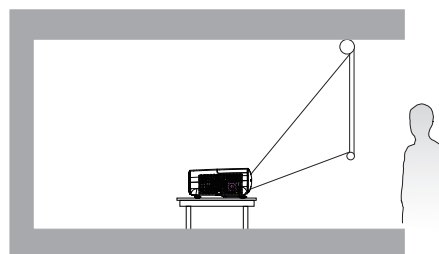

3. Front Ceiling

Select this location with the projector suspended upside-down in front of the screen. Purchase the BenQ Projector Ceiling/Wall Mount Kit from your dealer to mount your projector.

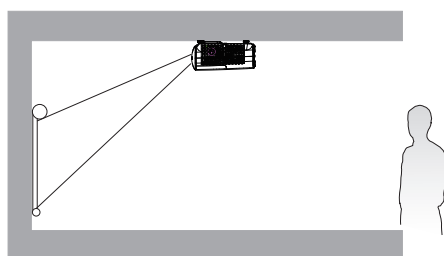

4. Rear Ceiling

Select this location with the projector suspended upside-down from behind the screen. Note that a special rear projection screen and the BenQ Projector Ceiling/Wall Mount Kit are required for this installation location.

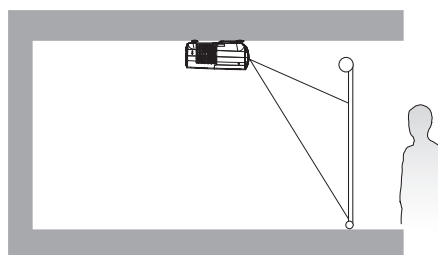

You can do one of the steps below to choose **Projector Position**:

1. If this is the first time you turn on the projector, the first step in setup wizard will guide you to select a setting. See [Starting up the projector](#).
2. From **BenQ Launcher** home page, go to **Settings > Preference > Installation > Projector installation** and select a setting.

Obtaining a preferred projected image size

The distance from the projector lens to the screen, the zoom setting (if available), and the video format each factors in the projected image size.

Projection dimensions

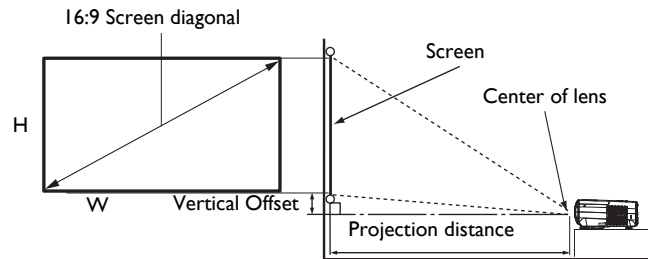

- The screen aspect ratio is 16:9 and the projected picture is in a 16:9 aspect ratio

| Screen size | | | | Distance from screen (mm) | | | Vertical offset (mm) |
|-------------|------|--------|--------|---------------------------|---------|-------------|----------------------|
| Diagonal | | H (mm) | W (mm) | Min length | Average | Max length | |
| Inch | mm | | | (max. zoom) | | (min. zoom) | |
| 30 | 762 | 374 | 664 | 957 | 1007 | 1057 | 21 |
| 40 | 1016 | 498 | 886 | 1291 | 1358 | 1425 | 28 |
| 50 | 1270 | 623 | 1107 | 1624 | 1708 | 1792 | 35 |
| 60 | 1524 | 747 | 1328 | 1958 | 2059 | 2160 | 41 |
| 80 | 2032 | 996 | 1771 | 2625 | 2760 | 2895 | 55 |
| 100 | 2540 | 1245 | 2214 | 3293 | 3462 | 3631 | 69 |
| 120 | 3048 | 1494 | 2657 | 3960 | 4163 | 4366 | 83 |
| 140 | 3556 | 1743 | 3099 | 4627 | 4864 | 5101 | 97 |
| 160 | 4064 | 1992 | 3542 | 5295 | 5566 | 5837 | 111 |
| 180 | 4572 | 2241 | 3985 | 5962 | 6267 | 6572 | 124 |
| 200 | 5080 | 2491 | 4428 | 6629 | 6968 | 7307 | 138 |
| 220 | 5588 | 2740 | 4870 | 7296 | 7670 | 8043 | 152 |
| 250 | 6350 | 3113 | 5535 | 8297 | 8722 | 9146 | 173 |
| 300 | 7620 | 3736 | 6641 | 9966 | 10475 | 10984 | 207 |

For example, if you are using a 120-inch screen, the recommended projection distance is 4163 mm.

If your measured projection distance is 6000 mm, the closest match in the "Distance from screen (mm)" column is 6267 mm. Looking across this row shows that a 180" (about 4.6 m) screen is required.

Mounting the projector

If you intend to mount your projector, we strongly recommend that you use a proper fitting BenQ projector mounting kit and that you ensure it is securely and safely installed.

If you use a non-BenQ brand projector mounting kit, there is a safety risk that the projector may fall down due to an improper attachment through the use of the wrong gauge or length screws.

Before mounting the projector

- Purchase a BenQ projector mounting kit from the place you purchased your BenQ projector.
- BenQ recommends that you also purchase a separate Kensington lock compatible security cable and attach it securely to both the Kensington lock slot on the projector and the base of the mounting

bracket. This will perform the secondary role of restraining the projector should its attachment to the mounting bracket become loose.

- Ask your dealer to install the projector for you. Installing the projector on your own may cause it to fall and result in injury.
- Take necessary procedures to prevent the projector from falling off such as during an earthquake.
- The warranty doesn't cover any product damage caused by mounting the projector with a non-BenQ brand projector mounting kit.
- Consider the surrounding temperature where the projector is ceiling/wall mounted. If a heater is used, the temperature around the ceiling/wall may be higher than expected.
- Read the user manual for the mounting kit about the range of torque. Tightening with torque exceeding the recommended range may cause damage to the projector and subsequently falling off.
- Make sure the power outlet is at an accessible height so that you can easily shut down the projector.

Ceiling/Wall mount installation diagram

Ceiling/Wall mount screw: M4
(Max L = 25 mm; Min L = 20 mm)

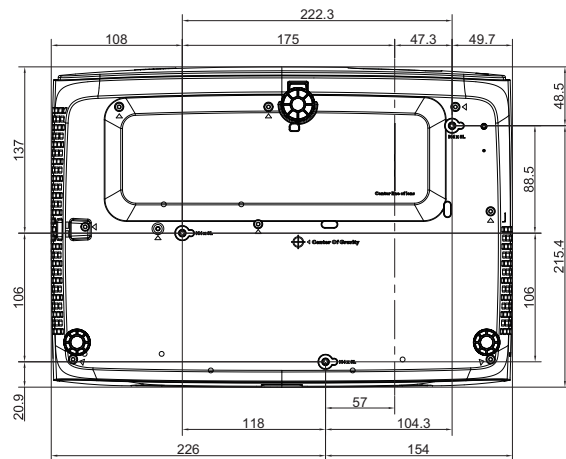

Unit: mm

Operation

Installing the USB wireless dongle

Follow the illustrations below to install the USB wireless dongle. Make sure that the lamp cover is installed back after the USB wireless dongle is plugged. Do not turn the power on with the lamp cover open.

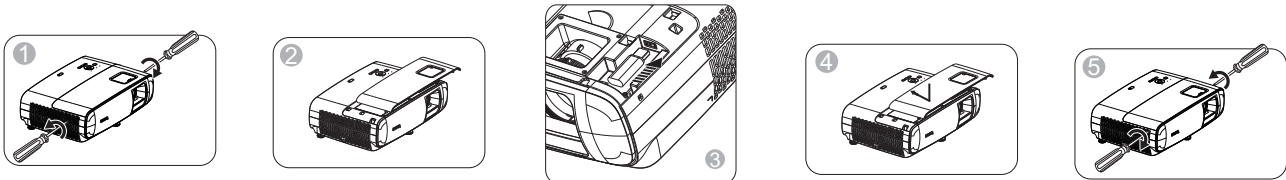





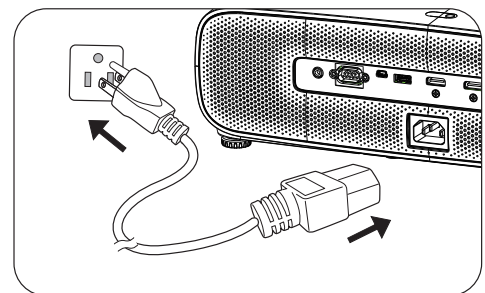

Starting up the projector

1. Plug the power cord. Turn on the power outlet switch (where fitted). The power indicator on the projector lights orange after power has been applied.
2. Plug the USB wireless dongle. It is highly recommended to plug it into the hidden dongle port located under the lamp cover. If not, the 2 USB ports in the rear view also support USB wireless dongle.
3. Press  on the projector or remote control to start the projector. The power indicator flashes green and stays green when the projector is on.



The start up procedure takes about 30 seconds. In the later stage of start up, a startup logo is projected.

(If necessary) Rotate the focus ring to adjust the image clearness.

4. If this is the first time you turn on the projector, the setup wizard appears to guide you through setting up the projector. If you have already done this, skip this step and move on to the next step.
 - Use the arrow keys (, , , ) on the projector or remote control to move through the menu items.
 - Use **OK** to confirm the selected menu item.
 - Use  **Back** to return to the previous menu.
 - Use  **Android Menu** on remote control to skip a menu.

Step 1:

Select **Projector installation**.

For more information about projector position, see [Choosing a location](#).

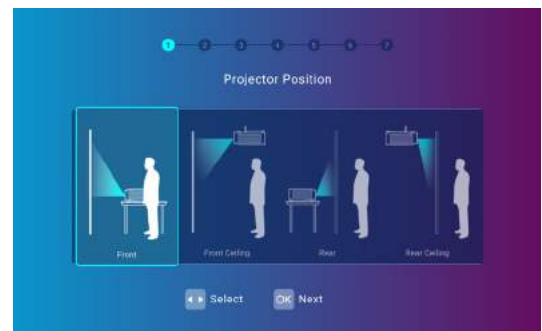

Step 2:

Select **Language**.



Step 3:

Configure the **Remote Control Pairing**

Press **Home** and **Menu** on the remote control at the same time for at least 3 seconds until the LED Indicator is flashing for pairing. If pairing is completed, then the LED Indicator will stop flashing.

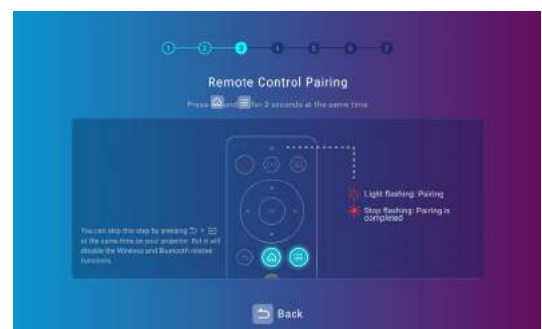

Step 4:

Adjust **Vertical Keystone**.

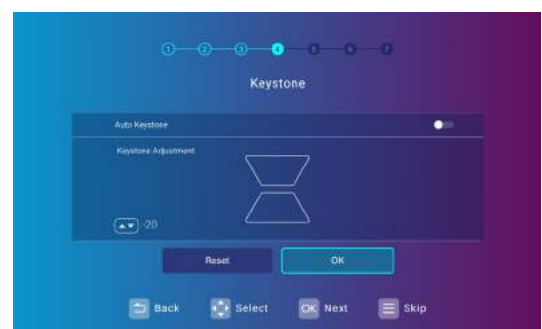

Step 5:

Configure the **Wireless Network Setting** settings by selecting the wireless network and entering the password.



To connect to a hidden wireless network select **Add New Network** and enter the **SSID**, security setting, and password for the network.

Step 6:
Select **Time Zone**.

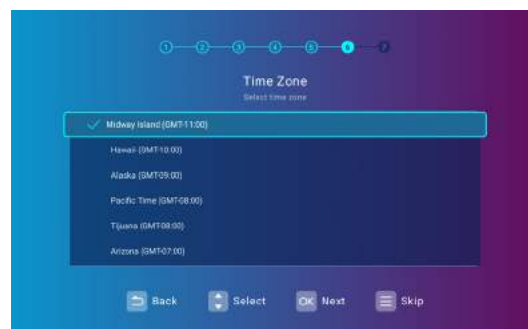



Step 7:
Read **Privacy Policy** and press **OK**.
You've completed the setup wizard; you may now connect a device to the projector to project video. See [Connection on page 22](#) for more information.



- ! Please use the original accessories (e.g. power cord) to avoid possible dangers such as electric shock and fire.
- ! If the projector is still hot from previous activity, it will run the cooling fan for approximately 90 seconds before energizing the lamp.
- ! The Setup Wizard screenshots are for reference only and may differ from the actual design.
- ! If the frequency/resolution of the input signal exceeds the projector's operating range, you will see the message "Out of Range" displayed on the background screen. Please change to an input signal which is compatible with the projector's resolution or set the input signal to a lower setting. See [Timing chart on page 55](#).

Shutting down the projector

1. Press  and a confirmation message will appear prompting you. If you don't respond in a few seconds, the message will disappear.
2. Press  a second time. The power indicator flashes orange, the projection lamp shuts down, and the fans will continue to run for approximately 90 seconds to cool down the projector.
3. Once the cooling process finishes, the power indicator becomes a steady orange and fans stop. Disconnect the power cord from the power outlet.

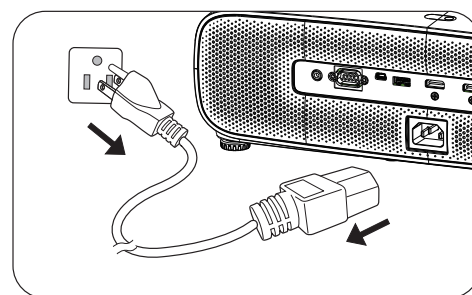

- ! To protect the lamp, the projector will not respond to any commands during the cooling process.
- ! Avoid turning on the projector immediately after turning it off as excessive heat may shorten lamp life.
- ! Lamp life results will vary depending on environmental conditions and usage.

Adjusting the projected image

Adjusting the projection angle

If the projector is not placed on a flat surface or the screen and the projector are not perpendicular to each other, the projected image becomes trapezoidal. You can screw the adjuster feet to fine-tune the horizontal angle.

To retract the feet, screw the adjuster feet in a reverse direction.

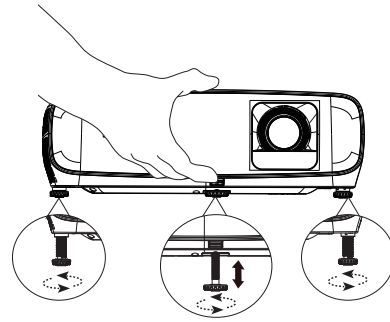

! Do not look into the lens while the lamp is on. The strong light from the lamp may cause damage to your eyes.

Fine-tuning the image size and clarity

Adjust the projected image to the size that you need using the zoom ring.

Sharpen the image by rotating the focus ring.

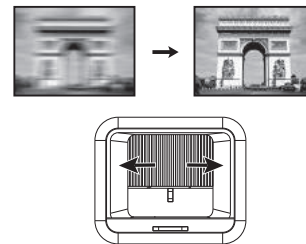
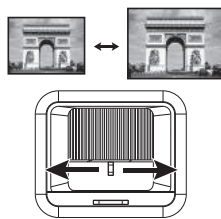

Correcting keystone

Keystoning refers to the situation where the projected image is noticeably wider at either the top or bottom. It occurs when the projector is not perpendicular to the screen.

To adjust the **Keystone**:

1. Select **Settings** from **BenQ Launcher** and press **OK**, or press  on the remote control or the projector.
2. Select **Display > Keystone** and press **OK**.
3. Disable the **Auto Keystone** setting.
4. Select **Keystone** and press **OK**.



- To correct keystoneing at the top of the image, use ▼ on your remote control.
- To correct keystoneing at the bottom of the image, use ▲ on your remote control.
- To return to default keystone settings press ☰ button on your remote control



You may only make these adjustments if Auto Keystone is disabled in the Installation menu. See [Keystone on page 40](#).

5. When you are done adjusting the keystone, press ⏪ to save your changes and return to the previous menu, or press 🏠 to save your changes and go back to the home screen directly.



BenQ Launcher

BenQ Launcher is the projector's operating system that allows you to project wirelessly, play media files or streaming apps, as well as adjust projector settings.



Use your remote control to operate **BenQ Launcher** functions. The projector's control panel keys are limited to control projector functions.

The BenQ Launcher home page

When the projector is not projecting an image from a connected source it will display **BenQ Launcher** by default. If the projector is projecting from a source, you can return to **BenQ Launcher** home page by pressing  or .



Actual screen may vary based on your **BenQ Launcher** firmware version.

The **BenQ Launcher** home page offers the following features:

- **Wireless Projection** - Provides instructions on how to project wirelessly via iOS/Android devices or a laptop/PC.
- **Status Bar** - Displays the connection status, date, and time.
- **Source List** - Selects input source for **USB**, **HDMI1** or **HDMI2**.
- **App Shortcuts** - Quick accesses to the **Aptoide** app market, **WPS Office** app and other apps.
- **Settings** - Accesses to **General**, **Display**, and **Preference** menus.

Navigating the BenQ Launcher home page

1. From **BenQ Launcher** home page, press ▲/▼/◀/▶ on your remote control to select the desired function and press **OK**.
2. Follow on-screen instructions for further operations.

Using the app shortcuts

Press the down ▼ button from **BenQ Launcher** home page to access the app shortcuts section, which displays the pre-installed **Aptoide** app market for streaming apps, **WPS Office** app, as well as other apps that have been installed on the projector. Other default apps may appear based on language settings.

To access all the apps installed on the projector, see [All Apps on page 36](#). For details on how to re-order the shortcuts see [Home Screen on page 42](#).

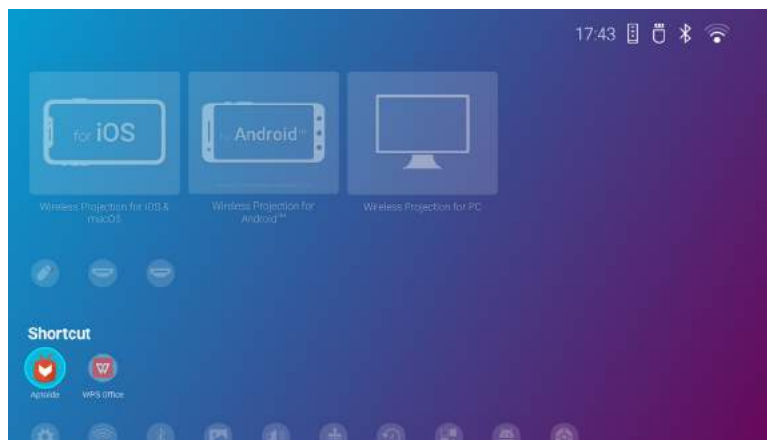

Using Voice Assistant

Press and hold the voice button to activate voice assistant. Hold this key and speak to the microphone at the top of the remote control while using voice assistant.



Using BenQ Launcher Settings

Select **Settings** from **BenQ Launcher** home page to access **General**, **Display** and **Preference** menus.



 Actual screen may vary based on your **BenQ Launcher** firmware version.

For more information on the **Settings** see [Using the Settings on page 34](#).

Typing texts

Various menus within **BenQ Launcher** may require to input text. To input text in a text field:

1. Select the text field where you want to input text.
2. Press **OK**, and a full alphanumeric keyboard will appear on screen.
3. Press **▲/▼/◀/▶** on your remote control to navigate the keyboard, and press **OK** to select the letter/key/symbol you want to enter into the text field.
4. Press **⏪** at anytime to exit out of the keyboard.

 Actual keyboard types may vary based on your language preference setting. See [Preference on page 42](#) for more information.

Connection

When connecting a signal source to the projector, be sure to:

1. Turn all equipment off before making any connections.
2. Use the correct signal cables for each source.
3. Ensure the cables are firmly inserted.

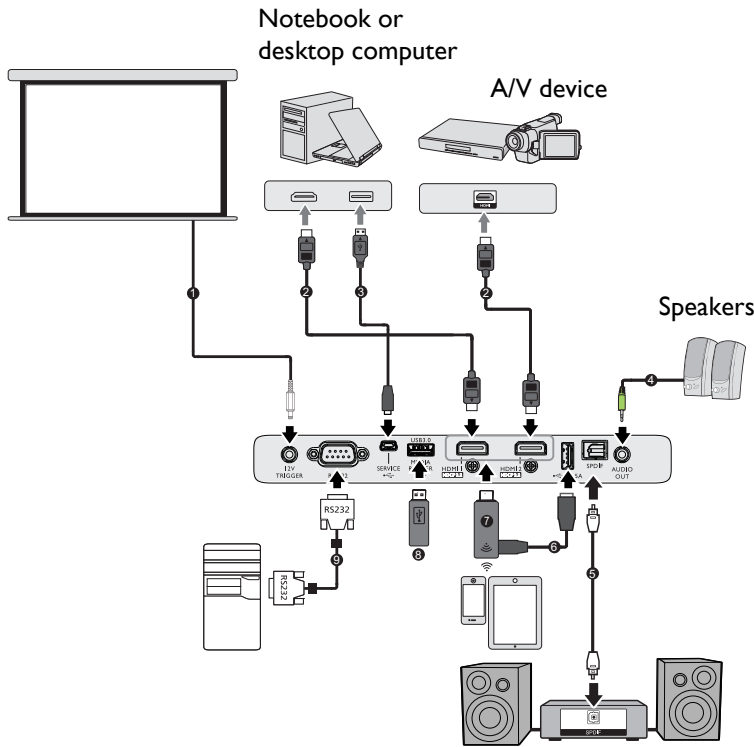

| | |
|---|---|
| 1 | I2V Trigger for screen control |
| 2 | HDMI cable |
| 3 | USB cable (Mini-B to A type) |
| 4 | Audio cable |
| 5 | SPDIF cable |
| 6 | USB cable (A to Micro B type) connect to the power port of HDMI wireless dongle |
| 7 | HDMI wireless dongle |
| 8 | USB Storage Device for Media Reader, Firmware Upgrade |
| 9 | RS232 cable |



- In the connections above, some cables may not be included with the projector (see [Shipping contents on page 7](#)). They are commercially available from electronics stores.
- The connection illustrations are for reference only. The rear connecting jacks available on the projector vary with each projector model.
- Many notebooks do not turn on their external video ports when connected to a projector. Usually a key combo like FN + function key with a monitor symbol turns the external display on/off. Press FN and the labeled function key simultaneously. Refer to your notebook's documentation to find your notebook's key combination.
- If the selected video image is not displayed after the projector is turned on and the correct video source has been selected, check that the video source device is turned on and operating correctly. Also check that the signal cables have been connected correctly.
- The built-in speaker(s) will be muted when the AUDIO OUT jack is connected.
- Please check your computer's baud rate at 9600 so that you can connect the projector by using a suitable RS-232 cable.

Wireless Connections

Connecting the projector to a wireless network

Before you can project wirelessly via the projector you must first connect the projector to a wireless network. To connect your projector to a wireless network, or to switch wireless networks:



If you have already connected the projector to a wireless network during the setup wizard you may skip the steps in this section.

1. Power on the projector (see [Starting up the projector on page 14](#)).
2. On the home page of **BenQ Launcher** interface, select **Wireless Network Setting** and press **OK** to access the wireless settings.



3. Select **Wireless Network** and press **OK** to enable wireless network.



4. Select the **SSID** for the wireless AP you want to connect to and press **OK**.



- It is highly recommended to use 5G frequency for better performance.
- To connect to a hidden wireless network select **Add New Network** and enter the **SSID**, security setting, and password for the network.
- The list of available wireless networks will be refreshed every 10 seconds. If the desired SSID is not listed please wait for refreshing to complete.

5. If you chose a secured **SSID** for the first time, a window appears prompting you to enter the appropriate password. Use the virtual keypad to enter the password. After you have entered the password, select **Next** and the projector will automatically connect.



- The password will be stored in the projector's memory. In the future, if you select the same SSID again, you will not be prompted to enter a password unless you delete the SSID from the projector's memory.
- If the password is typed incorrectly, you can select either **Try Again** to return to the virtual keypad or **View Available Networks** to return to the list of SSIDs.

6. Once you have successfully connected to the wireless AP a wireless connection icon will appear at the top right corner of **BenQ Launcher** interface. You can now connect your devices wirelessly to the projector to project videos.



Wireless Projection for iOS & macOS®

To connect an iOS device to the projector and project video via AirPlay:

1. On the home page of **BenQ Launcher** interface, select **Wireless Projection for iOS & macOS** and press **OK**.



2. On your iOS mobile device's wireless menu connect to the wireless network shown on the **Wireless Projection for iOS & macOS** screen and then select **Next**.

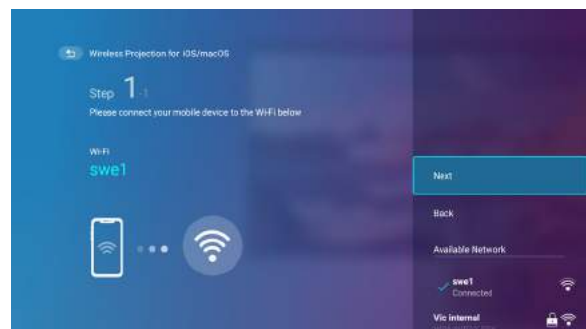

3. Follow the instructions shown on the **Wireless Projection for iOS & macOS** screen to project your iOS device's screen via AirPlay.

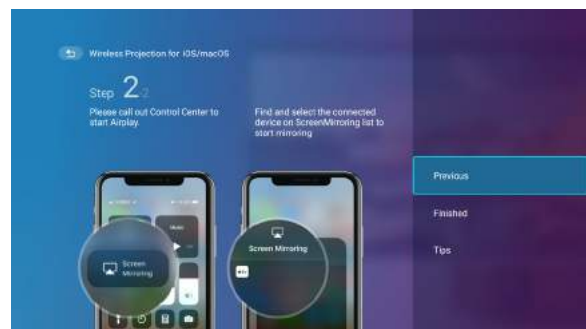

4. Select **Finished** on the **Wireless Projection for iOS & macOS** menu to finish the tutorial and return to the home screen.

Once you have finished projecting, disable AirPlay on your iOS device to end the connection.

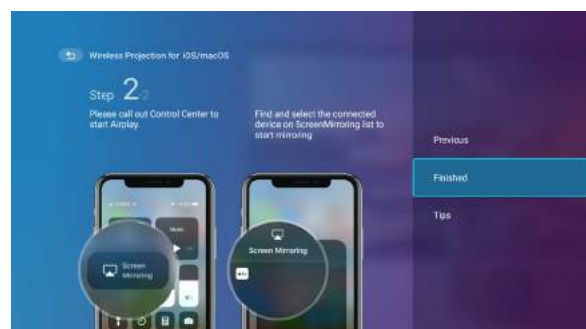

Wireless Projection for Android™

To connect an Android™ device to the projector and project video:

1. On the home page of **BenQ Launcher** interface, select **Wireless Projection for Android™** and press **OK**.

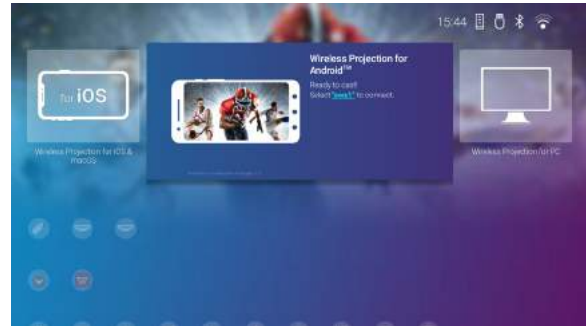

2. On your Android mobile device's wireless menu connect to the wireless network shown on the **Wireless Projection for Android™** screen and then select **Next**.

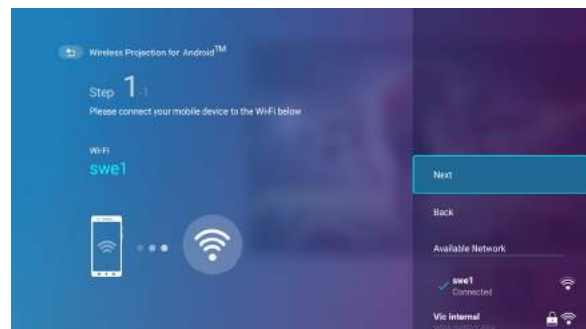

3. Follow the instructions shown on the **Wireless Projection for Android™** screen to project your Android device's screen.

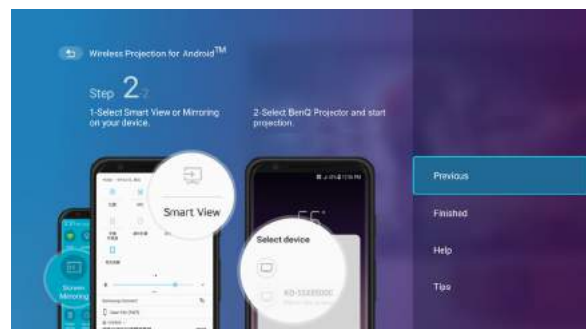

4. Select **Finished** on the **Wireless Projection for Android™** screen to finish the tutorial and return to the home screen.

Once you have finished projecting, disable screencasting on your Android device to end the connection.

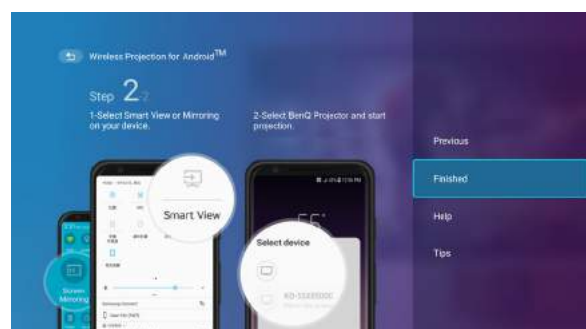

Wireless Projection for PC

To connect a PC to the projector and project video:

1. On the home page of **BenQ Launcher** interface, select **Wireless Projection for PC** and press **OK**.



2. On your PC's wireless menu connect to the wireless network shown on the **Wireless Projection for PC** screen and then select **Next**.



3. Follow the instructions shown on the **Wireless Projection for PC** screen to project your PC's screen.

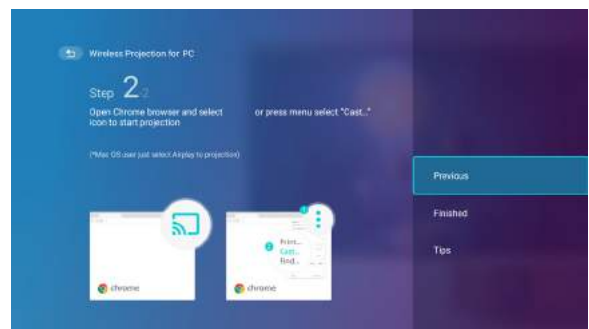

4. Select **Finished** on the **Wireless Projection for PC** screen to finish the tutorial and return to the home screen.

Once you have finished projecting, disable screencasting on your PC to end the connection.

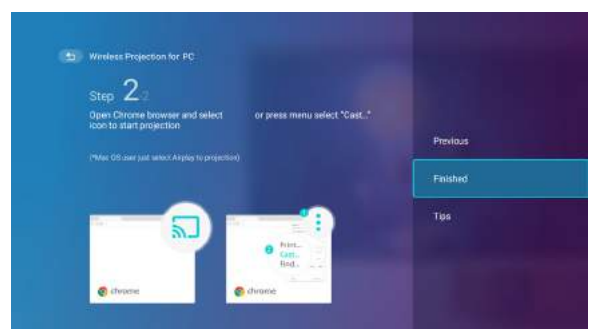

Wireless Hotspot

In situations where the projector is out-of-range of a wireless network (for example while on a camping trip), you can configure the projector to act as a wireless hotspot to create a closed network for devices to connect directly to the projector via a wireless connection and to project files from their local storage.

 The projector will have no access to the Internet while in wireless hotspot mode.

To create a wireless hotspot:

1. On the home page of **BenQ Launcher** interface, select **Settings** and press **OK**.



2. Select **Hotspot** and press **OK**.

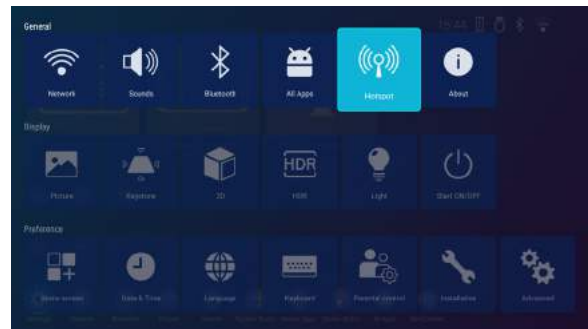

3. (Optional) Select **Hotspot Password** and press **OK** to change the password of the Wi-Fi hotspot.

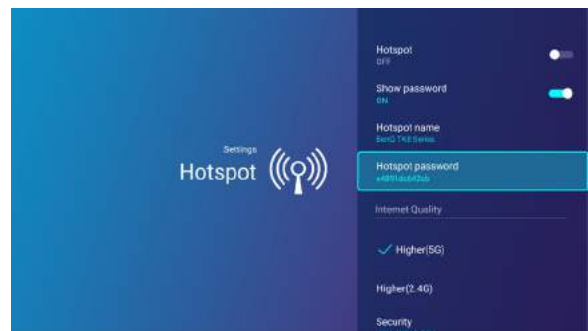

4. Select **Hotspot** and press **OK** to enable Wi-Fi hotspot.

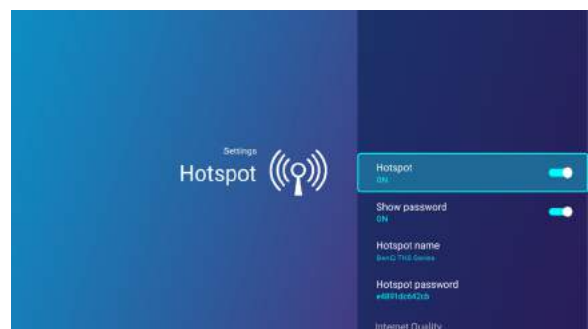

5. Once wireless hotspot is enabled, use the name shown in the **Hotspot Name** field as the SSID to connect to from your mobile device's wireless menu, enable **Show Password** to use the password shown in the **Hotspot Password** field as the connection password.

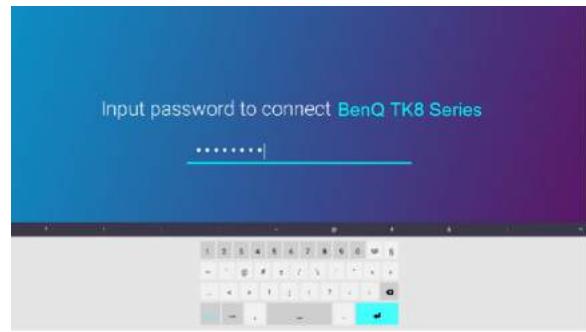

6. If the wireless hotspot can not be found by your device, select **2.4G** under the **Internet Quality**.



7. Select **Security** and press **OK** to change security Setting.

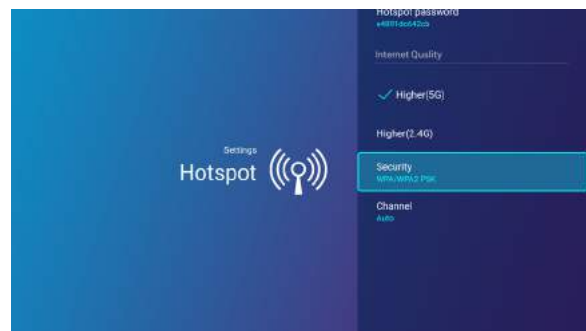

8. Select **Channel** and press **OK** to choose the best wireless channel.

After the wireless hotspot is setup, follow the corresponding connection instructions described in the previous section(s) to connect to the projector directly and project video.

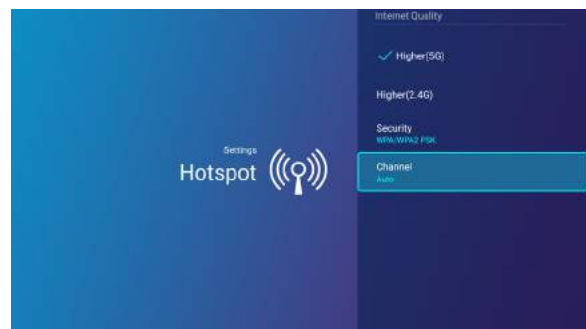

Bluetooth Connections

Connect to a Bluetooth-enabled speaker or headphones to output audio directly for greater sound particularly in outdoor settings.

Pairing/Connecting to a Bluetooth speaker or headphones

Pairing is the process by which your projector creates a connection to a Bluetooth speaker or headphones for the first time. Once both devices have been successfully paired each device will have the corresponding device's pairing information stored internally and both will be able to connect automatically when they are within an ~8 meter range of each other and Bluetooth is enabled on the projector.

To pair your projector to a Bluetooth speaker or headphones:

1. Enter **Settings**.
2. Select **Bluetooth** and press **OK**.
3. Enable **Bluetooth**.
4. Activate Bluetooth-pairing mode on the speaker or headphones.

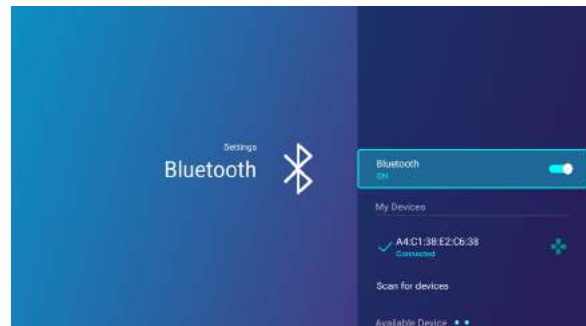

5. Select the speaker or headphones from the Available Device list and in the Bluetooth setting menu press **OK**.
6. When the projector and speaker or headphones have successfully connected the device listing in the Bluetooth setting menu will be labeled **Connected**, you can now output the audio from the projector to the speaker or headphone.



Once you have successfully paired your projector with the Bluetooth speaker, pairing information will be stored on both devices and a connection will automatically be made when Bluetooth is enabled on both devices and both devices are within range of each other.

Ending the Bluetooth connection

In cases where you want to disconnect a speaker or headphones from the projector and connect to another speaker or headphones follow the steps below:

1. Enter **Settings**.
2. Select **Bluetooth** and press **OK**.
3. Select the already connected speaker or headphones from the **Available Device** list in the **Bluetooth** menu and press **OK**.
4. Confirm that you want to disconnect the speaker or headphones from the projector.
5. Activate Bluetooth-pairing mode on the new speaker or headphones.

6. Select the new speaker or headphones from the **Available Device** list in the **Bluetooth** setting menu and press **OK**.



- If you are unable to find the speaker or headphones from the list of Bluetooth devices on the first try, ensure that pairing mode is activated on the device, then select **Scan** for devices in the Bluetooth setting menu to restart the scanning process.

- The projector cannot be used as a Bluetooth speaker.

Deactivating the Bluetooth speaker or headphones

To deactivate Bluetooth on the projector so that it no longer outputs its audio to a separate speaker or headphones:

1. Enter **Settings**.
2. Select **Bluetooth** and press **OK**.
3. Select **Bluetooth** and press **OK** to disable Bluetooth.



USB Connections

USB source allows you to access images, videos, and audio files for projection via internal memory or a USB flash drive.

To access the **USB** source in the **BenQ Launcher** home page press the down button ▼ on your remote control, and then select **USB**.



Select **Removable Disk** or **Internal Storage**.

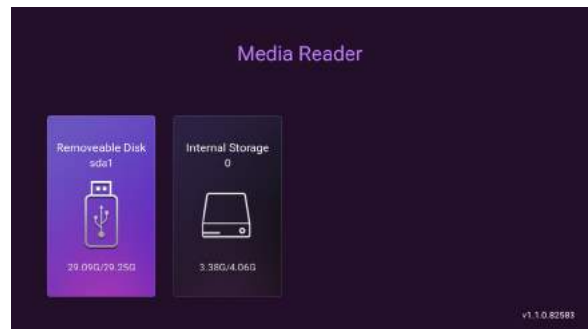

Each selection has a sub-directory that lists files for each of the following categories: **All**, **Video**, **Picture**, **Music**, **Doc**, and **App**.

Presenting from a Media Reader

The USB port on the projector allows you to browse the image and document files stored on a USB flash drive connected to the projector. It can eliminate the need for a computer source.

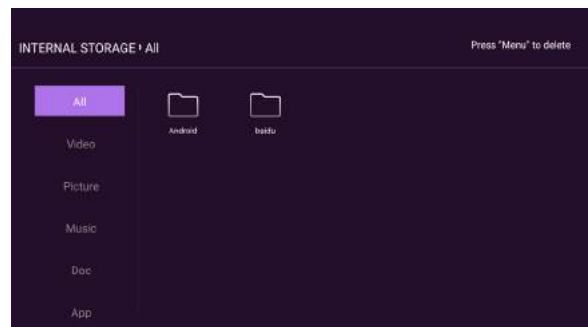

Supported files formats

| Video format | Audio format | Photo format |
|--|--|---|
| <ul style="list-style-type: none"> • MPEG1 • MPEG4 • H.263 • Motion JPEG | <ul style="list-style-type: none"> • MPEG1/2 Layer1 • MPEG1/2 Layer2 • FLAC | <ul style="list-style-type: none"> • JPEG Base-line • JPEG Progressive • PNG non-interlace • PNG interlace • BMP |

Software update

It is suggested that users regularly update their projector with the latest version of the firmware to optimize the user experience. The projector uses Over-the-Air (OTA) updates or USB updates to install the update file wirelessly.

To update software via internet:

1. Go to **Settings > General > About > Software Update** menu and press **OK**.



2. Select **Update** and press **OK**.
3. Select **DOWNLOAD** to download the update file.
4. Once the download is completed, the projector will restart automatically. Do not turn off or unplug the projector before the projector is finished updating and **BenQ Launcher** reappears on the screen.

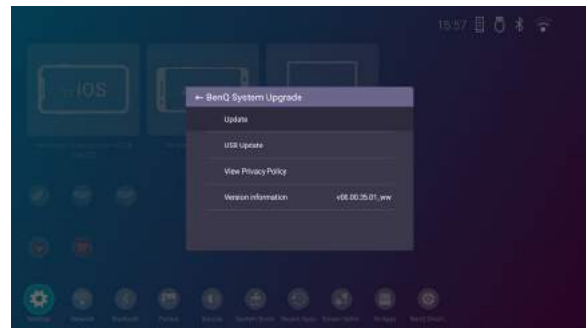

If you select **CANCEL** when the system upgrade message appears, a red dot will appear at the top right of the **Settings > General > About** menu, as a reminder that a newer version of firmware is available on the BenQ OTA server. Users can use the **Software Update > Update** function in the **Settings > General > About** menu to upgrade the system at any time.

To update software via USB flash drive:

1. Download the latest firmware version from BenQ Website.
2. File name will be: update_signed.zip. Unzip the file and save firmware in USB.
3. Insert USB key in USB 3.0 port.
4. Go to **Settings > General > About > Software Update** and press **OK**.
5. Select **USB Update** to select **On**.
6. In the process of upgrading, please keep power on until updating finished.
7. When you see this message, firmware upgrade is done.

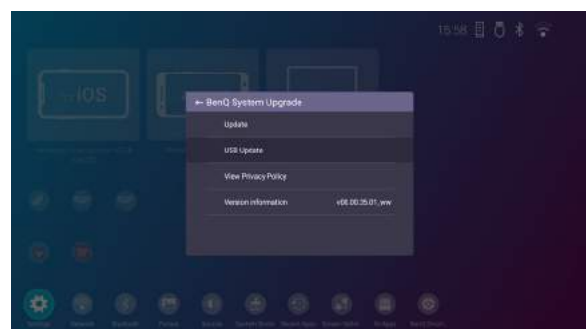
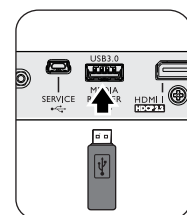

Navigating the Settings

To let you make various adjustments or settings on the projector, its wireless connections, and the projected image, **BenQ Launcher** provides a **Settings** menu. To access the **Settings**, press  , or select **Settings** from **BenQ Launcher** home page.





The following is the **Settings** menu:









Using the Settings

To access the various settings menus:



- Use the left and right arrow keys (/) to move through the main settings menus.
- Use **OK** to select the desired menu.

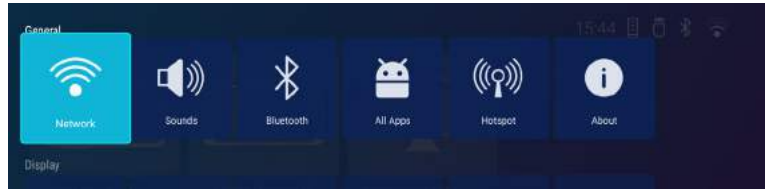

When configuring items within a menu:

- Use the up and down arrow keys (/) to move to the item you want to configure.
- Use left and right arrow keys (/) to toggle through the available options.
- Use **OK** to enable/disable options or select sub-menu options.
- Use the back button () to return to the main settings menu.
- Use the home button () to return to **BenQ Launcher** home page.

General



| | |
|-----------------------|---|
| <p>Network</p> | <ul style="list-style-type: none"> • Wireless Network Setting: Enables Wireless Network Setting for the projector. See Connecting the projector to a wireless network on page 23. • Speed Test: Tests the speed of the projector’s Internet connection. • Diagnosing: Diagnoses the status of the projector’s Internet connection. • SSID List: Lists the available wireless access points which the projector can connect to. See Connecting the projector to a wireless network on page 23. <p></p> <ul style="list-style-type: none"> • The SSID List is only available when Wireless Network Setting is enabled. • To connect to a hidden Wireless Network Setting select Add New Network and enter the SSID, security setting, and password for the network. |
| <p>Sounds</p> | <ul style="list-style-type: none"> • Sound Mode: Utilizes sound enhancement technology, which incorporates Waves’ algorithms to deliver great effects of the bass and treble and provide you with immersive cinematic audio experience. The following preset sound modes are provided: Standard, Cinema, Music, Game, Sports, and User. The User mode allows you to personalize the sound settings. When selecting the User mode, you may make manual adjustments with the User Mode Setting function. If the Mute function is activated, adjusting Sounds menu will turn off the Mute function. • User Mode Setting: Select desired frequency bands (100 Hz, 300 Hz, 1k Hz, 3k Hz, and 10k Hz) to adjust the levels according to your preference. The settings made here define the User mode. • Mute: Temporarily turns off the sound. • Volume: Adjusts the sound level. • L/R Switch: Switch the left/right audio channels. • SPDIF: Enable or disable S/PDIF. • ON/OFF Ring Tone: Turns on or off the ring tone when the projector is in startup and shutdown process. <p></p> <p>The only way to change ON/OFF Ring Tone is setting On or Off here. Setting the sound mute or changing the sound level will not affect the ON/OFF Ring Tone.</p> <ul style="list-style-type: none"> • Reset Audio Settings: All of the adjustments you’ve done for the Sound menu return to the factory preset values. |

| | |
|-------------------------|---|
| <p>Bluetooth</p> | <ul style="list-style-type: none"> • Bluetooth: Enables Bluetooth for the projector, allowing the projector to output its audio to a Bluetooth speaker or headphones. • Scan for devices: Selects the speaker or headphones from the Available Device. • Available Device: Lists the available Bluetooth devices which the projector can pair and connect to. Select Scan for devices if you want to refresh the list of devices.  <p>The Available Device is only available when Bluetooth is enabled.</p> |
| <p>All Apps</p> | <p>Access all the apps that have been installed on the projector. Press OK to active app. Press  to access more options as below:</p> <ul style="list-style-type: none"> • Open: Press OK to launch the selected app. • Permission Settings: Press OK to enter the selected app permission settings. • Uninstall: Press OK to uninstall the selected app. |
| <p>Hotspot</p> | <ul style="list-style-type: none"> • Hotspot: Enables or disables hotspot. See Wireless Hotspot on page 28. • Show Password: Enables or disables to show the password of the projector's wireless network hotspot when Security is set to WPA/WPA2 PSK. • Hotspot Name: Displays the name for the projector's wireless network hotspot, which appears in the wireless network list for devices looking to connect directly to the projector. • Hotspot Password: Shows or hides Hotspot Password. • Internet Quality: Sets 5G or 2.4G frequency. • Security: Press OK to choose security type. • Channel: Press OK to set wireless channel for best. |
| <p>About</p> | <ul style="list-style-type: none"> • Projector Information: Displays information on the current status of the projector including the current Source, Picture mode, Dynamic Range, Resolution, Color System, Color Gamut, Light Usage Time, 3D Format, System Version, BenQ Launcher Version, and Service Code. • System Information: Displays hardware/software information for the projector including Android Version, Internal storage, and Mac address. • Software Update: See Software update on page 33. • About Privacy: Displays the BenQ privacy announcement. • Reset All Settings: Returns all settings to the factory preset values. |



When QOTA icon  displays in **BenQ Launcher** hoem page, it indicates that a newer version of the projector's firmware is available. In such circumstances, users can click this icon to start the firmware update. QOTA icon will disappear once the projector is updated with the latest version of firmware. See [Software update on page 33](#).

Display



| | |
|-----------------------|---|
| <p>Picture</p> | <p>Picture mode</p> <p>The projector is preset with several predefined picture modes so that you can choose one to suit your operating environment and input signal picture type.</p> <ul style="list-style-type: none">• Bright: Maximizes the brightness of the projected image. This mode is suitable for environments where extra-high brightness is required, such as using the projector in well lit rooms.• Living Room: With well-saturated color, fine-tuned sharpness and a higher brightness level, Living Room mode is perfect for watching movies in a living room where there is a small amount of ambient light.• Cinema: Complement with accurate color and deepest contrast at lower brightness level, Cinema mode is suitable for playing movies in an environment with a bit of ambient light, like in living room.• Sports: Complement with Sport Mode settings which is suitable for watching sport events in a bright room with ambient light.• User: Recalls the settings customized based on the current available picture modes.• 3D: Is appropriate for playing 3D images and 3D video clips. <p> This mode is only available when 3D function is enabled.</p> <ul style="list-style-type: none">• HDR10: Delivers High Dynamic Range effects with higher contrasts of brightness and colors. This mode is only available when: HDR is set at Auto, and HDR10 content is detected.• HLG: Delivers Hybrid Long Gamma effects by adding a logarithmic curve with extra brightness over the top of the signal. This mode is only available when: HDR is set at Auto, and HLG content is detected. |
|-----------------------|---|

| | |
|---------------------------------------|--|
| | <p>User Mode Management</p> <ul style="list-style-type: none"> • Load Settings From <p>There is one user-definable mode if the current available picture modes are not suitable for your need. You can use one of the picture modes (except the User) as a starting point and customize the settings.</p> <ol style="list-style-type: none"> 1. Go to Picture > Picture mode. 2. Press ◀/▶ to select User. 3. Press ▼ to highlight User Mode Management and press OK. 4. Press ▼ to select Load Settings From and press OK. 5. Press ▼ to select a picture mode that is closest to your need. 6. Press ▼ to select the sub-menu items you want to change and adjust the values with ◀/▶. The adjustments define the selected user mode. |
| <p>Picture (Continued)</p> | <p>Adjust</p> <ul style="list-style-type: none"> • Brightness: The higher the value, the brighter the image. Adjust this control so the black areas of the image appear just as black and that detail in the dark areas is visible. • Contrast: The higher the value, the greater the contrast. Use this to set the peak white level after you have previously adjusted the Brightness setting to suit your selected input and viewing environment. • Color: Lower setting produces less saturated colors. If the setting is too high, colors on the image will be overpowering, which makes the image unrealistic. • Tint: The higher the value, the more greenish the picture becomes. The lower the value, the more reddish the picture becomes. • Sharpness: The higher the value, the sharper the picture becomes. |
| | <p>Advanced</p> <ul style="list-style-type: none"> • Gamma Selection: Gamma refers to the relationship between input source and picture brightness. Choose a preferred gamma mode from among 1.8/2.0/2.1/2.2/2.3/2.4/2.5/2.6/BenQ. |

Picture
(Continued)

- **HDR Brightness:** The projector can automatically adjust the brightness levels of your image according to the input source. You can also manually select a brightness level to display better picture quality. When the value is higher, the image becomes brighter; when the value is lower, the image becomes darker.

- **Color Temperature:** There are several preset color temperature settings available. The available settings may vary according to the signal type selected.

- **Preset:** Selects a color temperature from among **Normal**, **Cool**, **Lamp Native**, or **Warm**.

You can also set a preferred color temperature by adjusting the following options.

- **Red Gain/Green Gain/Blue Gain:** Adjusts the contrast levels of Red, Green, and Blue.
- **Red Offset/Green Offset/Blue Offset:** Adjusts the brightness levels of Red, Green, and Blue.

- **Color Management:** This function provides six sets (RGBCMYW) of colors to be adjusted. When you select each color, you can independently adjust its range and saturation according to your preference.

- **Primary Color:** Selects a color from among **R** (Red), **G** (Green), **B** (Blue), **C** (Cyan), **M** (Magenta), **Y** (Yellow), or **W** (White).

- **Hue:** Increase in the range will include colors consisted of more proportions of its two adjacent colors. Please refer to the illustration for how the colors relate to each other. For example, if you select Red and set its range at 0, only pure red in the projected picture will be selected. Increasing its range will include red close to yellow and red close to magenta.

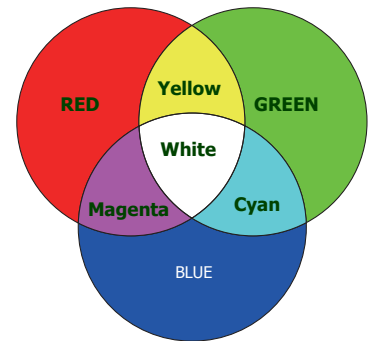

- **Saturation:** Adjusts the values to your preference. Every adjustment made will reflect to the image immediately. For example, if you select Red and set its value at 0, only the saturation of pure red will be affected.



Saturation is the amount of that color in a video picture. Lower settings produce less saturated colors; a setting of "0" removes that color from the image entirely. If the saturation is too high, that color will be overpowering and unrealistic.

- **Gain:** Adjusts the values to your preference. The contrast level of the primary color you select will be affected. Every adjustment made will reflect to the image immediately.



When "**White**" is selected, "**Hue/Saturation/Gain**" is changed into "**Red Gain/Green Gain/Blue Gain**".

| | |
|---------------------------------------|--|
| <p>Picture (Continued)</p> | <ul style="list-style-type: none"> • CinemaMaster <ul style="list-style-type: none"> • Color Enhancer: Allows you to fine-tune the saturation of colors with larger flexibility. It modulates complex color algorithms to flawlessly render saturated colors, fine gradients, intermediate hues and subtle pigments. • Flesh Tone: Provides a smart adjustment of hue only for calibrating people's skin color, not other colors in the image. It prevents discoloration of skin tones from the light of the projection beam, portraying every skin tone in its most beautiful shade. • Pixel Enhancer 4K: It is a super-resolution technology which radically enhances Full HD content in terms of colors, contrast, and textures. It's also a Detail Enhancement Technology refines surface details for true-to-life images that pop off the screen. Users can adjust levels of sharpness and detail enhancement for optimal viewing. • Motion Enhancer 4K: You can use this feature to smooth fast-moving videos by comparing consecutive image frames and inserting an intermediate image frame between them. |
| | <ul style="list-style-type: none"> • Noise Reduction: Reduces electrical image noise caused by different media players. |
| | <ul style="list-style-type: none"> • Brilliant Color: This feature utilizes a new color-processing algorithm and system level enhancements to enable higher brightness while providing truer, more vibrant colors in picture. It enables a greater than 50% brightness increase in mid-tone images, which are common in video and natural scenes, so the projector reproduces images in realistic and true colors. |
| | <ul style="list-style-type: none"> • LumiExpert: To actively detects ambient light conditions in viewing environment and automatically adjusts balanced visual brightness for maximum comfort. Available under any picture mode, except for Brightness mode and 3D. <ul style="list-style-type: none"> • On/Off: Selects to enable or disable the LumiExpert. • Level: Adjusts the gamma offset in each picture mode but except for Brightness and 3D mode. |
| | <ul style="list-style-type: none"> • Light Mode: Selects a suitable lamp power from among the provided modes. See Extending light source life on page 47. |
| | <ul style="list-style-type: none"> • Reset Current Picture Mode Returns all of the adjustments you've made for the selected Picture mode to the factory preset values. |
| <p>Keystone</p> | <ul style="list-style-type: none"> • Auto Keystone: Enable this function to allow the projector to automatically adjust the keystone settings when powered on. See Correcting keystone on page 17. • Keystone: Displays Vertical Keystone (w/ Auto) menu same as setup wizard. |

| | |
|----------------------------|--|
| <p>3D</p> | <p>This projector features a 3D function which enables you to enjoy the 3D movies, videos, and sporting events in a more realistic way by presenting the depth of the images. You need to wear a pair of 3D glasses to view the 3D images.</p> <ul style="list-style-type: none"> • 3D Mode: The default setting is Auto and the projector automatically chooses an appropriate 3D format when detecting 3D contents. If the projector cannot recognize the 3D format, manually choose a 3D mode according to your preference. • 3D Sync Invert: When your 3D image is distorted, enable this function to switch between the image for the left eye and the right eye for more comfortable 3D viewing experience. |
| <p>HDR</p> | <p>The projector supports HDR imaging sources. It can automatically detect the dynamic range of the source for SDR or HDR10 or HLG, and optimize settings to reproduce contents under wider dynamic range. Meanwhile, the Picture mode cannot be adjusted after switching to HDR. It also includes HDR Brightness.</p> |
| <p>Light</p> | <ul style="list-style-type: none"> • Light Timer: See Getting to know the light hour on page 46. • Reset Light Timer: See Resetting the light timer on page 50. |
| <p>Start ON/OFF</p> | <ul style="list-style-type: none"> • Auto Off: Allows the projector to turn off automatically if no input signal is detected after a set period of time to prevent unnecessary waste of light life. • Direct Power On: Allows the projector to turn on automatically once the power is fed through the power cord. • Quick Cooling: Selecting On enables the function and the projector cooling time will be shortened to a few seconds. If you attempt to restart the projector right after the quick cooling process, it may not be turned on successfully and will rerun its cooling fans. |

Preference

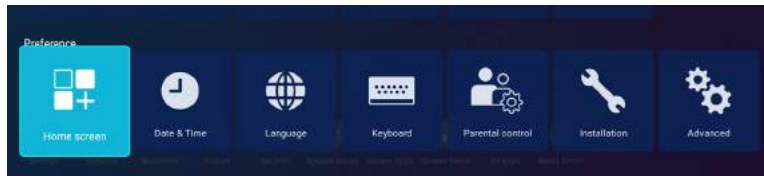

| | |
|--------------------------------|---|
| <p>Home Screen</p> | <p>Allows you to edit Shortcut or Settings displayed in BenQ Launcher home page.</p> <ul style="list-style-type: none"> • Shortcut: Edits to adjust or show/hide apps for Shortcut displayed in BenQ Launcher. <ul style="list-style-type: none"> • Auto: When Auto is On, the system will edit Shortcut apps automatically. • Manual: When Auto is Off, you can enter Manual to edit Shortcut apps. • Settings: Edits to adjust or show/hide settings for Settings displayed in BenQ Launcher. |
| <p>Date & Time</p> | <ul style="list-style-type: none"> • Automatic Date & Time: Enables Automatic Date & Time for the projector. • Time Zone: Sets the time zone for the projector. • Format: Sets the date and time display format. |
| <p>Language</p> | <p>Sets the language of the system.</p> |
| <p>Keyboard</p> | <ul style="list-style-type: none"> • BenQ Keyboard: Displays current keyboard. • BenQ Keyboard Setting: Add keyboard languages, and sets keyboard type. |
| <p>Parental Control</p> | <p>Allows parents to restrict the access of the projector to their children.</p> <ul style="list-style-type: none"> • System Passcode: Enables or disables the System Passcode for the projector by inputting the System Passcode. • Change System Passcode: Allows you to change the System Passcode. You are required to input the System Passcode before change. • Forget Passcode: Scan the QR code on the screen to decode your System Passcode. • Auto Power Off: Enters System Passcode to enables or disables Auto Power Off. • Time Setting: Sets the length of time the projector will turn off automatically. You are required to input the System Passcode before change. |

Installation

- **Projector installation:** The projector can be installed on a ceiling or behind a screen, or with one or more mirrors.
- **Test Pattern:** Adjusts the image size and focus and check that the projected image is free from distortion.

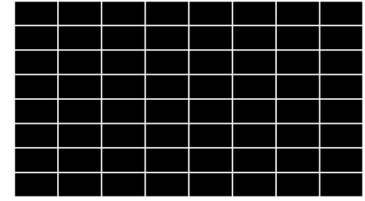

- **High Altitude**

We recommend you use the **High Altitude** when your environment is between 1500 m –3000 m above sea level, and ambient temperature is between 0°C–30°C.

Operation under "**High Altitude**" may cause a higher decibel operating noise level because of increased fan speed necessary to improve overall system cooling and performance.

If you use this projector under other extreme conditions excluding the above, it may display auto shut-down symptoms, which is designed to protect your projector from over-heating. In cases like this, you should switch to **High Altitude** mode to solve these symptoms. However, this is not to state that this projector can operate under any and all harsh or extreme conditions.



Do not use the **High Altitude** if your altitude is between 0 m and 1500 m and ambient temperature is between 0°C and 35°C. The projector will be over cooled, if you turn the mode on under such a condition.

- **I2V Trigger:** If **On** is selected, the projector will send electronic signal out when it is turned on.

| | |
|------------------------|---|
| <p>Advanced</p> | <ul style="list-style-type: none"> • HDMI Format Selects a suitable color format to optimize display quality. <ul style="list-style-type: none"> • Auto: Automatically selects a suitable color space and gray level for the incoming HDMI signal. • RGB Limited: Utilizes the Limited range RGB 16-235. • RGB Full: Utilizes the Full range RGB 0-255. • YUV Limited: Utilizes the Limited range YUV 16-235. • YUV Full: Utilizes the Full range YUV 0-255. • HDMI Equalizer Adjusts the equalizer gain settings for an HDMI signal. The higher the setting, the stronger the gain value. If there are more than one HDMI port on the projector, select the HDMI port first before adjusting the value. • HDMI EDID Switch HDMI EDID between HDMI 1.4 or HDMI 2.0 in order to solve compatibility issue with uncertain old players. <ul style="list-style-type: none"> • Enhanced: Enhanced mode can switch to HDMI 2.0 EDID • Standard: Standard mode can switch to HDMI 1.4 EDID. • Audio Return (HDMI-I) Enable or disable the Audio Return function which is only support on HDMI-I. <ul style="list-style-type: none"> • On: Enable Audio Return to return audio to speaker. When connecting to ARC (Audio Return Channel) compatible speaker to the projector with HDMI cables, the audio can be returned to these speaker from the projector. • Off: Disable Audio Return function. • LED Indicator You can turn off the LED warning lights. This is to avoid any light disturbance when viewing images in a dark room. • Menu Settings: Sets the parameter tuning position. |
|------------------------|---|

Other menus

The other menus are available in **BenQ Launcher** home page.

System Boots

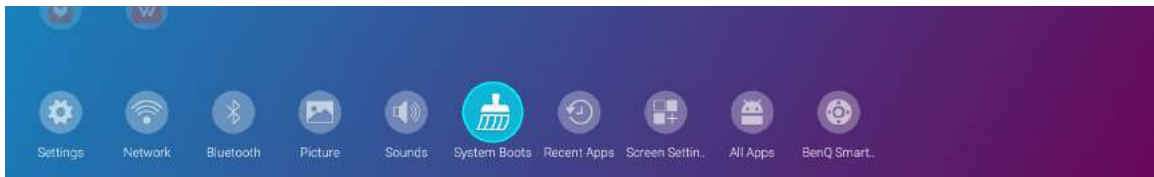

Select **System Boots** menu to clear temporary caches in **BenQ Launcher**.

Recent Apps

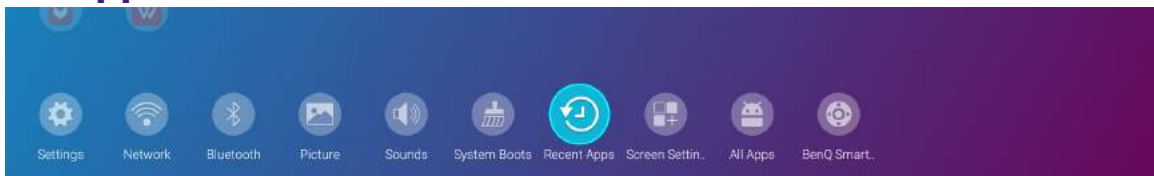

Select **Recent Apps** menu to access a list of apps that have been recently used.

- Select any icon and press the down button (▼) to remove the icon from the list of recently used apps.
- Select any icon and press the menu button (☰) on the remote control to clear all icons from the list of recently used apps.

BenQ Smart Control

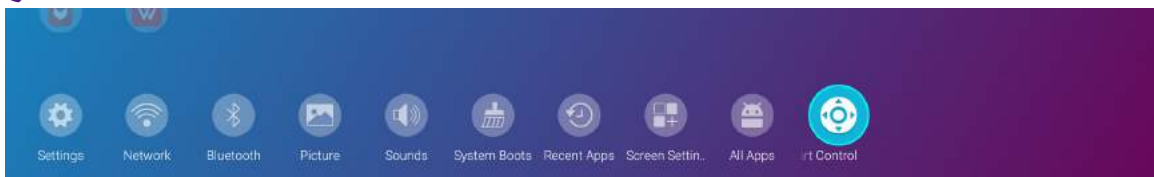

Select **BenQ Smart Control** menu to download smart control app for better control.

- Please make your mobile device and projector connect to the same wireless network, and then scan the QR code displayed on the screen or enter the web site address displayed on the screen to download the **BenQ Smart Control** app on your smart phone.



If you are unable to install the **BenQ Smart Control** app, make sure your smart phone is allowed to install of apps from sources other than the Play Store or App Store.

Maintenance

Care of the projector

Cleaning the lens

Clean the lens whenever you notice dirt or dust on the surface. Please be sure to turn off the projector and let it cool down completely before cleaning the lens.

- Use a canister of compressed air to remove dust.
- If there is dirt or smears, use lens-cleaning paper or moisten a soft cloth with lens cleaner and gently wipe the lens surface.
- Never use any type of abrasive pad, alkaline/acid cleaner, scouring powder, or volatile solvent, such as alcohol, benzene, thinner or insecticide. Using such materials or maintaining prolonged contact with rubber or vinyl materials may result in damage to the projector surface and cabinet material.

Cleaning the projector case

Before you clean the case, turn the projector off using the proper shutdown procedure as described in [Shutting down the projector on page 16](#) and unplug the power cord.

- To remove dirt or dust, wipe the case with a soft, lint-free cloth.
- To remove stubborn dirt or stains, moisten a soft cloth with water and a neutral pH detergent. Then wipe the case.



Never use wax, alcohol, benzene, thinner or other chemical detergents. These can damage the case.

Storing the projector

If you need to store the projector for an extended time, please follow the instructions below:

- Make sure the temperature and humidity of the storage area are within the recommended range for the projector. Please refer to [Specifications on page 53](#) or consult your dealer about the range.
- Retract the adjuster feet.
- Remove the battery from the remote control.
- Pack the projector in its original packing or equivalent.

Transporting the projector

It is recommended that you ship the projector with its original packing or equivalent.

Light information

Getting to know the light hour

When the projector is in operation, the duration (in hours) of light usage is automatically calculated by the built-in timer. The method of calculating the equivalent lamp hour is as follows:

1. Light Usage Time = (x+y+z) hours, if
Time used in Normal mode = x hours
Time used in Eco mode = y hours
Time used in SmartEco mode = z hours

2. Equivalent Light Usage Time = α hours

$$\alpha = \frac{A'}{X} \times X + \frac{A'}{Y} \times Y + \frac{A'}{Z} \times Z, \text{ if}$$

X = light source life spec of Normal mode

Y = light source life spec of Eco mode

Z = light source life spec of SmartEco mode

A' is the longest light source life spec among X, Y, Z



For Time used in each lamp mode shown in OSD menu:

- Time used is accumulated and rounded down to an integer in Hours.

- When time used is less than 1 hour, it shows 0 hours.

When you calculate Equivalent Light Usage Hour manually, it will probably have deviation from the value shown in OSD menu since projector system calculates Time used for each lamp mode in "Minutes" then rounds down to an integer in hours shown in OSD.

To obtain the light hour information:

1. From **BenQ Launcher** home page, go to **Settings** > **Display** > **Light** and press **OK**. The **Light** page appears.
2. Press **▼** to select **Light Timer** and press **OK**. The **Light Timer** information is displayed.

Extending light source life

• Setting the **Light Mode**

From **BenQ Launcher** home page, go to **Settings** > **Display** > **Picture** > **Advanced** and press **OK**. Press **▼** to select **Light Mode** and select a suitable lamp power from among the provided modes.

Setting the projector in **Economic** or **SmartEco** mode extends lamp life.

| Light Mode | Description |
|-----------------|--|
| Normal | Provides full light brightness |
| Economic | Lowers brightness to extend the light life and decreases the fan noise |
| SmartEco | Adjusts the light power automatically depending on the content brightness level while optimizing display quality |

• Setting **Auto Off**

This function allows the projector to turn off automatically if no input signal is detected after a set period of time to prevent unnecessary waste of light source life.

To set **Auto Off**, go to **Settings** > **Display** > **Start ON/OFF** > **Auto Off** and select a setting.

Timing of replacing the lamp

When the **Lamp indicator** lights up or a message appears suggesting it is time to replace the lamp, please consult your dealer or go to <http://www.BenQ.com> before installing a new lamp. An old lamp may cause a malfunction in the projector and in some instances the lamp may explode.



- The apparent brightness of the projected image will vary depending on the ambient lighting conditions, selected input signal contrast/brightness settings, and is directly proportional to projection distance.
- The lamp brightness will decline over time and may vary within the lamp manufacturers specifications. This is normal and expected behavior.
- The **LAMP indicator light** and **TEMPerature warning light** will light up if the lamp becomes too hot. Turn the power off and let the projector cool for 45 minutes. If the Lamp or Temp indicator still lights up after turning the power back on, please contact your dealer. See [Indicators on page 51](#).

The following Lamp warning displays will remind you to change the lamp.

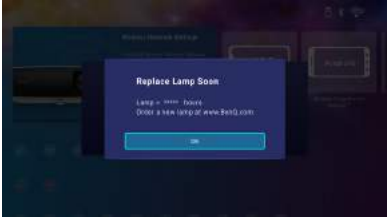
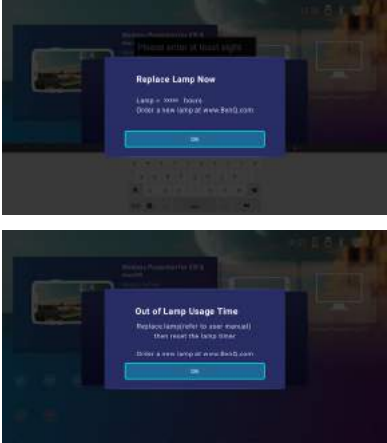
| | |
|---|---|
|  | <p>It is strongly recommended that you replace the lamp at this age. The lamp is a consumable item. The lamp brightness diminishes with use. This is normal lamp behavior. You can replace the lamp whenever you notice that the brightness level has significantly diminished. Press OK to dismiss the message.</p> |
|  | <p>The lamp MUST be replaced before the projector will operate normally. Press OK to dismiss the message.</p> |



"XXXXX" shown in the above messages are numbers that vary depending on different models.

Replacing the lamp



- To reduce the risk of electrical shock, always turn the projector off and disconnect the power cord before changing the lamp.
 - To reduce the risk of severe burns, allow the projector to cool for at least 45 minutes before replacing the lamp.
 - To reduce the risk of injuries to fingers and damage to internal components, use caution when removing lamp glass that has shattered into sharp pieces.
 - To reduce the risk of injuries to fingers and/or compromising image quality by touching the lens, do not touch the empty lamp compartment when the lamp is removed.
 - This lamp contains mercury. Consult your local hazardous waste regulations to dispose of this lamp in a proper manner.
 - To assure optimal performance from the projector, it is recommended that you purchase a qualified projector lamp for lamp replacement.
 - If lamp replacement is performed while the projector is suspended upside-down, make sure that no one is underneath the lamp socket to avoid any possible injury or damage to the human eyes caused by fractured lamp.
 - Ensure good ventilation when handling broken lamps. We recommend that you use respirators, safety glasses, goggles or face shield and wear protective clothing such as gloves.
1. Turn the power off and disconnect the projector from the power outlet. If the lamp is hot, avoid burns by waiting for approximately 45 minutes until the lamp has cooled.
 2. Loosen the screw(s) that secure the lamp cover on the side of the projector until the lamp cover loosens.

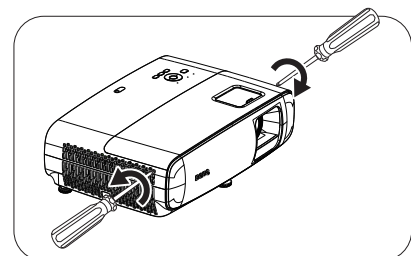

3. Remove the lamp cover from the projector.



- Do not turn the power on with the lamp cover open.
- Do not insert your fingers between the lamp and the projector. The sharp edges inside the projector may cause injuries

4. Remove the safety mylar.

5. Disconnect the lamp connector.

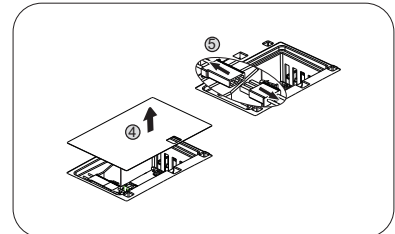
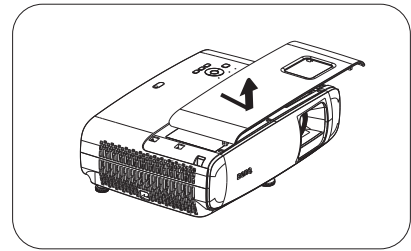

6. Loosen the screw(s) that secure the inner lamp.

7. Lift the handle so that it stands up.

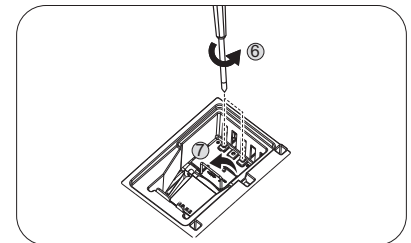

8. Use the handle to slowly pull the lamp out of the projector.



- Pulling it too quickly may cause the lamp to break and scatter broken glass in the projector.
- Do not place the lamp in locations where water might splash on it, children can reach it, or near flammable materials.
- Do not insert your hands into the projector after the lamp is removed. The sharp edges inside the projector may cause injuries. If you touch the optical components inside, it could cause color unevenness and distortion of the projected images.

9. Insert the lamp connector.

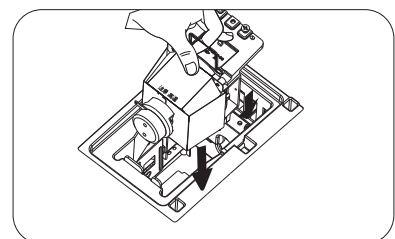
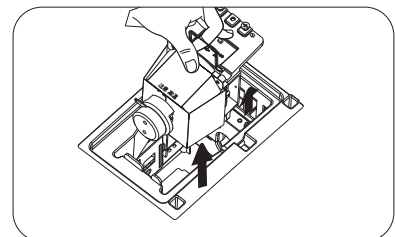

10. Tighten the screw(s) that secures the lamp.

11. Ensure the handle is fully laid flat and locked in place.



- Loose screw may cause a bad connection, which could result in malfunction.
- Do not over tighten the screw.

12. Connect the lamp connector.

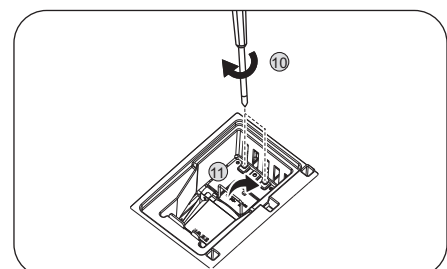

13. Put the safety mylar back to the top.

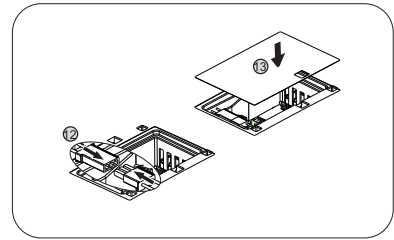

14. Replace the lamp cover on the projector.

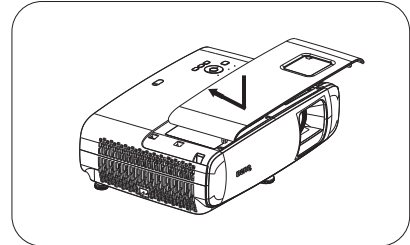

15. Tighten the screw that secures the lamp cover.



- Loose screw may cause a bad connection, which could result in malfunction.
- Do not over tighten the screw.

16. .Connect the power and restart the projector.

Resetting the light timer

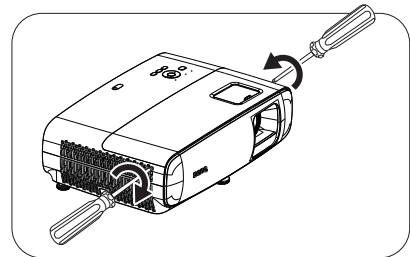

17. After the startup logo, open the On-Screen Display

































(OSD) menu. Go to **Settings > Display > Light** and press **OK**. The **Light** page appears.









Highlight **Reset Light Timer** and press **OK**. A warning message is displayed asking if you want to reset the lamp timer. Highlight **Reset** and press **OK**. The lamp time will be reset to "0".



- Do not reset if the lamp is not new or replaced as this could cause damage.

Indicators

| Light | | | Status & Description |
|---|---|---|---|
| POWER ○ | TEMP ○ | LAMP ○ | |
| System events | | | |
|  |  |  | System is in stand-by mode |
|  |  |  | System is powering up |
|  |  |  | System is under normal operation |
|  |  |  | System is cooling down |
|  |  |  | Downloading |
|  |  |  | Colorwheel start fail |
|  |  |  | Scaler reset fail |
|  |  |  | Lamp life exhausted |
|  |  |  | Lamp door is not closed |
| Burn-In events | | | |
|  |  |  | Burn-in on |
|  |  |  | Burn-in off |
| Lamp events | | | |
|  |  |  | Lamp error in normal operation |
|  |  |  | Lamp is not lit up |
| Thermal events | | | |
|  |  |  | Fan 1 error (the actual fan speed is outside the desired speed) |
|  |  |  | Fan 2 error (the actual fan speed is outside the desired speed) |
|  |  |  | Fan 3 error (the actual fan speed is outside the desired speed) |
|  |  |  | Fan 4 error (the actual fan speed is outside the desired speed) |
|  |  |  | Temperature 1 error (over limited temperature) |

| | | | | |
|---|--|--|--|--|
|  |  : Off |  : Orange On  : Orange Flashing |  : Green On  : Green Flashing |  : Red On  : Red Flashing |
|---|--|--|--|--|

Troubleshooting

? The projector does not turn on.

| Cause | Remedy |
|---|---|
| There is no power from the power cord. | Plug the power cord into the AC power jack on the projector, and plug the power cord into the power outlet. If the power outlet has a switch, make sure that it is switched on. |
| Attempting to turn the projector on again during the cooling process. | Wait until the cooling down process has completed. |
| The lamp cover is not installed properly. | Make sure that the lamp cover is installed correctly, and the screws are also tightened. See Wireless Connections on page 23 . |

? No picture

| Cause | Remedy |
|--|--|
| The video source is not turned on or connected correctly. | Turn the video source on and check that the signal cable is connected correctly. |
| The projector is not correctly connected to the input signal device. | Check the connection. |
| The input signal has not been correctly selected. | Select the correct input signal with the Source key. |
| The lens cover is still closed. | Open the lens cover. |

? Blurred image

| Cause | Remedy |
|--|--|
| The projection lens is not correctly focused. | Adjust the focus of the lens using the focus ring. |
| The projector and the screen are not aligned properly. | Adjust the projection angle and direction as well as the height of the projector if necessary. |

? Remote control does not work.

| Cause | Remedy |
|--|---|
| The batteries are out of power. | Replace both of the batteries with new ones. |
| There is an obstacle between the remote control and the projector. | Remove the obstacle. |
| You are too far away from the projector. | Stand within 8 meters (26 feet) of the projector. |
| The batteries are installed incorrectly. | Make sure the polarities correctly match the positive and negative ends marked inside the battery compartment. See Replacing the remote control batteries on page 7 . |

? The password is incorrect.

| Cause | Remedy |
|-----------------------------------|---|
| You do not remember the password. | See Parental Control on page 42 . |

Specifications

Projector specifications



All specifications are subject to change without notice.

Optical

Resolution

3840 x 2160 with XPR

Display system

1-CHIP DMD

Lens

F = 2 ~ 2.2, f = 15.7 ~ 17.27 mm

Clear focus range

1.3 m ~ 5.1 m @ Wide,

1.0 m ~ 3.8 m @ Tele

Lamp

245 W lamp

Zoom ratio

1.1X

Electrical

Power supply

AC100–240V, 3.4 A, 50–60 Hz (Automatic)

Power consumption

350 W (Max); 0.5 W (Standby)

Mechanical

Weight

3.9 Kg ± 200 g (8.6 lbs ± 0.44 lbs)

Output terminals

Speaker

5 watt x 1

Audio signal output

PC audio jack x 1

SPDIF to optical x 1

Control

USB

Type-A (USB 3.0) x 1: Media reader/drive,

Firmware download (5V 1.5A)

Type-A (USB 2.0) x 1: Power supply (5V, 2.5A)

Mini-B x 1, Type-A (USB wireless dongle) x 1

12V DC x 1: Trigger for screen control

RS-232 serial control

9 pin x 1

IR receiver x 2

Input terminals

Video signal input

HDMI (2.0b, HDCP 2.2) x 2

Environmental Requirements

Operating temperature

0°C–40°C at sea level

Operating relative humidity

10%–90% (without condensation)

Operating altitude

0–1499 m at 0°C–35°C

1500–3000 m at 0°C–30°C (with

High Altitude Mode on)

Storage temperature

-20°C–60°C at sea level

Storage humidity

10%–90% RH (without condensation)

Storage altitude

30°C@ 0~12,200m above sea level

Transporting

Original packing or equivalent is recommended

Repairing

Please visit below website and choose your country to find your service contact window.

<http://www.benq.com/welcome>

Dimensions

380 mm (W) x 128 mm (H) x 267 mm (D)

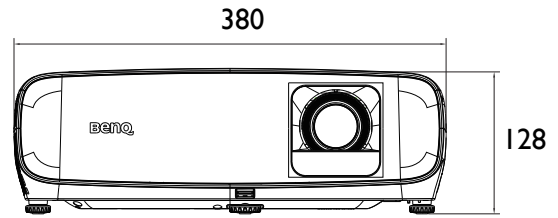
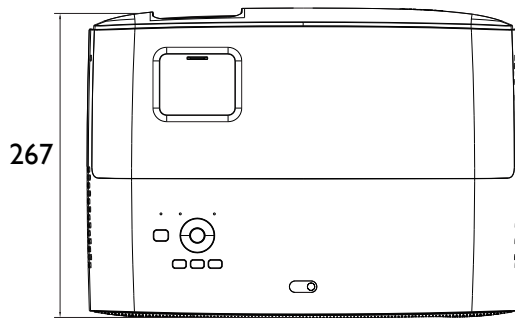

Unit: mm

Timing chart

Supported timing for HDMI (HDCP) input

- PC timings

| Resolution | Mode | Vertical Frequency (Hz) | Horizontal Frequency (kHz) | Pixel Frequency (MHz) | Supported 3D format | |
|-------------------|---|-------------------------|----------------------------|-----------------------|---------------------|--------------|
| | | | | | Top Bottom | Side by Side |
| 640 x 480 | VGA_60 | 59.940 | 31.469 | 25.175 | | |
| | VGA_72 | 72.809 | 37.861 | 31.500 | | |
| | VGA_75 | 75.000 | 37.500 | 31.500 | | |
| | VGA_85 | 85.008 | 43.269 | 36.000 | | |
| 720 x 400 | 720 x 400_70 | 70.087 | 31.469 | 28.3221 | | |
| 800 x 600 | SVGA_60 | 60.317 | 37.879 | 40.000 | | |
| | SVGA_72 | 72.188 | 48.077 | 50.000 | | |
| | SVGA_75 | 75.000 | 46.875 | 49.500 | | |
| | SVGA_85 | 85.061 | 53.674 | 56.250 | | |
| 1024 x 768 | SVGA_120 (Reduce Blanking) | 119.854 | 77.425 | 83.000 | | |
| | XGA_60 | 60.004 | 48.363 | 65.000 | V | V |
| | XGA_70 | 70.069 | 56.476 | 75.000 | | |
| | XGA_75 | 75.029 | 60.023 | 78.750 | | |
| 1024 x 768 | XGA_85 | 84.997 | 68.667 | 94.500 | | |
| | XGA_120 (Reduce Blanking) | 119.989 | 97.551 | 115.5 | | |
| 1152 x 864 | 1152 x 864_75 | 75 | 67.5 | 108 | | |
| 1024 x 576@60Hz | BenQ Notebook Timing | 60.00 | 35.820 | 46.996 | | |
| 1024 x 600@65Hz | BenQ Notebook Timing | 64.995 | 41.467 | 51.419 | | |
| 1280 x 720 | 1280 x 720_60 | 60 | 45.000 | 74.250 | V | V |
| 1280 x 768 | 1280 x 768_60 | 59.870 | 47.776 | 79.5 | V | V |
| 1280 x 800 | WXGA_60 | 59.810 | 49.702 | 83.500 | V | V |
| | WXGA_75 | 74.934 | 62.795 | 106.500 | | |
| | WXGA_85 | 84.880 | 71.554 | 122.500 | | |
| | WXGA_120 (Reduce Blanking) | 119.909 | 101.563 | 146.25 | | |
| 1280 x 1024 | SXGA_60 | 60.020 | 63.981 | 108.000 | V | V |
| | SXGA_75 | 75.025 | 79.976 | 135.000 | | |
| | SXGA_85 | 85.024 | 91.146 | 157.500 | | |
| 1280 x 960 | 1280 x 960_60 | 60.000 | 60.000 | 108 | V | V |
| | 1280 x 960_85 | 85.002 | 85.938 | 148.500 | | |
| 1360 x 768 | 1360 x 768_60 | 60.015 | 47.712 | 85.500 | V | V |
| 1440 x 900 | WXGA+_60 | 59.887 | 55.935 | 106.500 | V | V |
| 1400 x 1050 | SXGA+_60 | 59.978 | 65.317 | 121.750 | V | V |
| 1600 x 1200 | UXGA | 60.000 | 75.000 | 162.000 | V | V |
| 1680 x 1050 | 1680 x 1050_60 | 59.954 | 65.290 | 146.250 | V | V |
| 640 x 480@67Hz | MAC13 | 66.667 | 35.000 | 30.240 | | |
| 832 x 624@75Hz | MAC16 | 74.546 | 49.722 | 57.280 | | |
| 1024 x 768@75Hz | MAC19 | 75.020 | 60.241 | 80.000 | | |
| 1152 x 870@75Hz | MAC21 | 75.06 | 68.68 | 100.00 | | |
| 1920 x 1080@60Hz | 1920 x 1080_60 | 60 | 67.5 | 148.5 | V | V |
| 1920 x 1200@60Hz | 1920 x 1200_60 (Reduce Blanking) | 59.95 | 74.038 | 154 | V | V |
| 1920 x 1080@120Hz | 1920 x 1080_120 (Only HDMI 2.0 support) | 120.000 | 135.000 | 297 | | |
| 3840 x 2160 | 3840 x 2160_30 For 4K2K model | 30 | 67.5 | 297 | | |
| 3840 x 2160 | 3840 x 2160_60 For 4K2K model (Only HDMI 2.0 support) | 60 | 135 | 594 | | |



The timings showing above may not be supported due to EDID file and VGA graphic card limitations. It is possible that some timings cannot be chosen.

• Video timings

| Timing | Resolution | Horizontal Frequency (kHz) | Vertical Frequency (Hz) | Dot Clock Frequency (MHz) | Supported 3D format | | |
|----------|-------------------------------------|----------------------------|-------------------------|---------------------------|---------------------|------------|--------------|
| | | | | | Frame Packing | Top Bottom | Side by Side |
| 480i | 720 (1440) x 480 | 15.73 | 59.94 | 27 | | | |
| 480p | 720 x 480 | 31.47 | 59.94 | 27 | | | |
| 576i | 720 (1440) x 576 | 15.63 | 50 | 27 | | | |
| 576p | 720 x 576 | 31.25 | 50 | 27 | | | |
| 720/50p | 1280 x 720 | 37.5 | 50 | 74.25 | V | V | V |
| 720/60p | 1280 x 720 | 45.00 | 60 | 74.25 | V | V | V |
| 1080/24P | 1920 x 1080 | 27 | 24 | 74.25 | V | V | V |
| 1080/25P | 1920 x 1080 | 28.13 | 25 | 74.25 | | | |
| 1080/30P | 1920 x 1080 | 33.75 | 30 | 74.25 | | | |
| 1080/50i | 1920 x 1080 | 28.13 | 50 | 74.25 | | | V |
| 1080/60i | 1920 x 1080 | 33.75 | 60 | 74.25 | | | V |
| 1080/50P | 1920 x 1080 | 56.25 | 50 | 148.5 | | V | V |
| 1080/60P | 1920 x 1080 | 67.5 | 60 | 148.5 | | V | V |
| 2160/24P | 3840 x 2160 (Only HDMI 2.0 support) | 54 | 24 | 297 | | | |
| 2160/25P | 3840 x 2160 (Only HDMI 2.0 support) | 56.25 | 25 | 297 | | | |
| 2160/30P | 3840 x 2160 (Only HDMI 2.0 support) | 67.5 | 30 | 297 | | | |
| 2160/50P | 3840 x 2160 (Only HDMI 2.0 support) | 112.5 | 50 | 594 | | | |
| 2160/60P | 3840 x 2160 (Only HDMI 2.0 support) | 135 | 60 | 594 | | | |

Color Depth Table

| Display format (refresh rate) | Chroma subsampling | 8 Bit | 10 Bit | 12 Bit |
|-------------------------------|--------------------|-------|--------|--------|
| 4K/60p (60 Hz) | 04:04:04 | Yes | No | No |
| | 04:02:02 | Yes | Yes | Yes |
| | 04:02:00 | Yes | Yes | Yes |
| 4K/24p (24 Hz) | 04:04:04 | Yes | Yes | Yes |
| | 04:02:02 | Yes | Yes | Yes |
| | 04:02:00 | Yes | Yes | Yes |