



Digital Projector
User Manual

Warranty and Copyright information

Limited warranty

BenQ warrants this product against any defects in material and workmanship, under normal usage and storage.

Proof of purchase date will be required with any warranty claim. In the event this product is found to be defective within the warranty period, BenQ's only obligation and your exclusive remedy shall be replacement of any defective parts (labor included). To obtain warranty service, immediately notify the dealer from which you purchased the product of any defects.

Important: The above warranty shall be void if the customer fails to operate the product in accordance with BenQ's written instructions, especially the ambient humidity must be in-between 10% and 90%, temperature in-between 0°C and 35°C, altitude lower than 4920 feet, and avoiding to operate the projector in a dusty environment. This warranty gives you specific legal rights, and you may have other rights which vary from country to country.

For other information, please visit www.BenQ.com.

Copyright

Copyright © 2021 by BenQ Corporation. All rights reserved. No part of this publication may be reproduced, transmitted, transcribed, stored in a retrieval system or translated into any language or computer language, in any form or by any means, electronic, mechanical, magnetic, optical, chemical, manual or otherwise, without the prior written permission of BenQ Corporation.

Disclaimer

BenQ Corporation makes no representations or warranties, either expressed or implied, with respect to the contents hereof and specifically disclaims any warranties, merchantability or fitness for any particular purpose. Further, BenQ Corporation reserves the right to revise this publication and to make changes from time to time in the contents hereof without obligation to notify any person of such revision or changes.

*DLP, Digital Micromirror Device and DMD are trademarks of Texas Instruments. Others are copyrights of their respective companies or organizations.

Patents

Please go to <http://patmarking.benq.com/> for the details on BenQ projector patent coverage.

Table of Contents

Warranty and Copyright information	2
Important safety instructions	4
Introduction	8
Shipping contents	8
Projector exterior view	10
Controls and functions.....	11
Positioning your projector	15
Obtaining a preferred projected image size	15
Adjusting the projected image.....	16
Connection	17
Operation	18
Starting up the projector	18
QS01 Android TV setup	19
Using the menus	22
Securing the projector	22
Switching input signal	24
Presenting from a USB flash drive	25
Shutting down the projector	27
Menu operation	28
Menu system	28
PICTURE menu	31
DISPLAY menu.....	36
INSTALLATION menu	37
SYSTEM SETUP: BASIC menu	37
SYSTEM SETUP: ADVANCED menu	38
INFORMATION menu	40
Maintenance	41
Care of the projector	41
Light source information	42
Troubleshooting	44
Specifications	45
Projector specifications	45
Dimensions	46
Timing chart.....	47

Important safety instructions

Your projector is designed and tested to meet the latest standards for safety of information technology equipment. However, to ensure safe use of this product, it is important that you follow the instructions mentioned in this manual and marked on the product.

1. **Please read this manual before you operate your projector.** Save it for future reference.

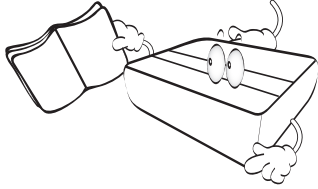

2. **Do not look straight at the projector lens during operation.** The intense light beam may damage your eyes.

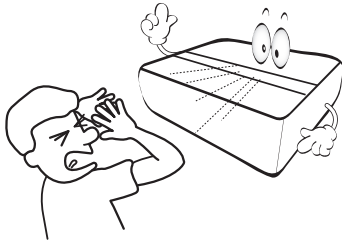

3. **Refer servicing to qualified service personnel.**

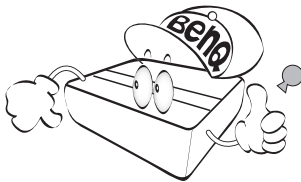

4. **Always open the lens shutter (if any) or remove the lens cap (if any) when the projector light source is on.**

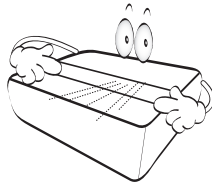

5. The light source becomes extremely hot during operation.

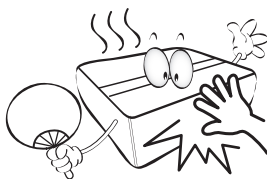

6. In some countries, the line voltage is NOT stable. This projector is designed to operate safely within a mains voltage between 100 to 240 volts AC, but could fail if power cuts or surges of ± 10 volts occur. **In areas where the mains voltage may fluctuate or cut out, it is recommended that you connect your projector through a power stabilizer, surge protector or uninterruptible power supply (UPS).**

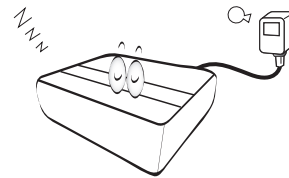

7. Do not block the projection lens with any objects when the projector is under operation as this could cause the objects to become heated and deformed or even cause a fire.

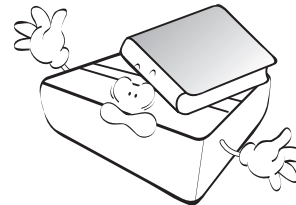

8. Do not operate light sources beyond the rated light source life.

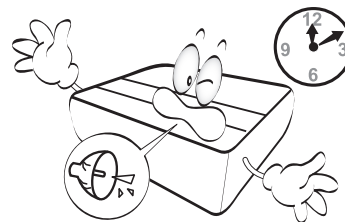

9. Do not place this product on an unstable cart, stand, or table. The product may fall, sustaining serious damage.

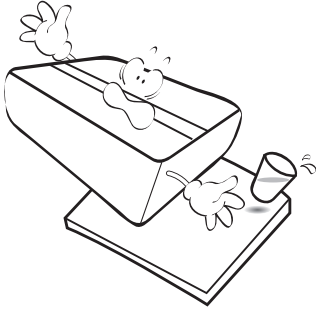

10. Do not attempt to disassemble this projector. There are dangerous high voltages inside which may cause death if you should come into contact with live parts. The only user serviceable part is the light source which has its own removable cover.

Under no circumstances should you ever undo or remove any other covers. Refer servicing only to suitably qualified professional service personnel.

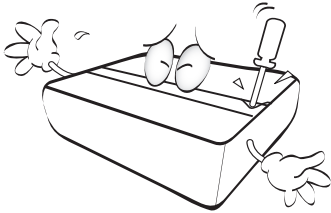

11. Do not block the ventilation holes.

- Do not place this projector on a blanket, bedding or any other soft surface.
- Do not cover this projector with a cloth or any other item.
- Do not place inflammables near the projector.

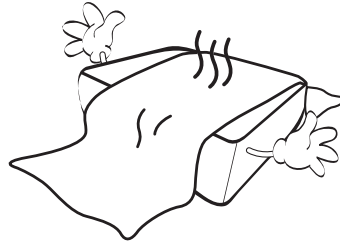

If the ventilation holes are seriously obstructed, overheating inside the projector may result in a fire.

12. Always place the projector on a level, horizontal surface during operation.

- Do not use if tilted at an angle of more than 10 degrees left to right, nor at angle of more than 15 degrees front to back. Using the projector when it is not fully horizontal may cause a malfunction of, or damage to, the light source.

13. Do not stand the projector on end vertically. Doing so may cause the projector to fall over, causing injury or resulting in damage to the projector.

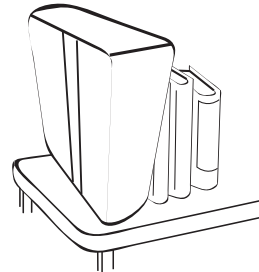

14. Do not step on the projector or place any objects upon it. Besides probable physical damage to the projector, doing so may result in accidents and possible injury.

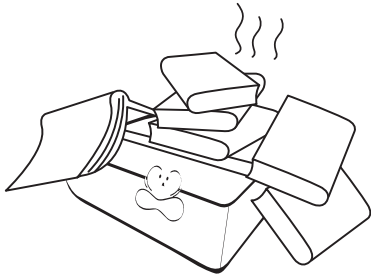

15. When the projector is under operation, you may sense some heated air and odor from its ventilation grill. It is a normal phenomenon and not a product defect.
16. Do not place liquids near or on the projector. Liquids spilled into the projector may cause it to fail. If the projector does become wet, disconnect it from the power supply's power outlet and call BenQ to have the projector serviced.

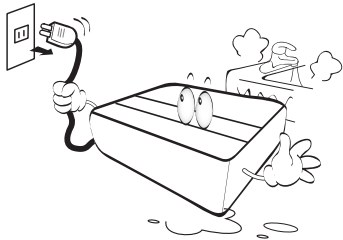

17. This apparatus must be earthed.



To avoid damaging the DLP chips, never aim a high-power laser beam into the projection lens.

18. Do not place this projector in any of the following environments.

- Space that is poorly ventilated or confined. Allow at least 50 cm clearance from walls and free flow of air around the projector.
- Locations where temperatures may become excessively high, such as the inside of a car with all windows rolled up.
- Locations where excessive humidity, dust, or cigarette smoke may contaminate optical components, shorten the projector's life span and darken the image.

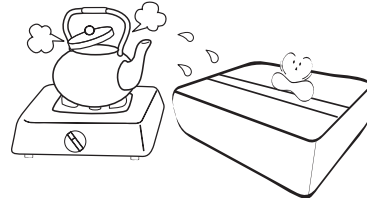

- Locations near fire alarms
- Locations with an ambient temperature above 40°C / 104°F
- Locations where the altitudes are higher than 3000 m (10000 feet).

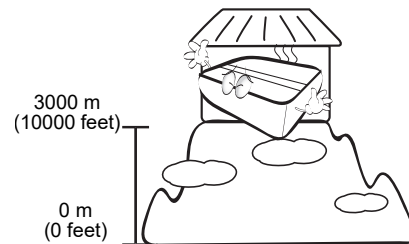

Risk Group 2

1. According to the classification of photobiological safety of light sources and light source systems, this product is Risk Group 2, IEC 62471-5:2015.
2. Possibly hazardous optical radiation emitted from this product.
3. Do not stare at operating light source. May be harmful to the eyes.
4. As with any bright source, do not stare into the direct beam.



The projector's light source unit uses the laser.

Laser Caution

This product belongs to CLASS I laser product and complies with IEC 60825-1:2014.



Above laser cautions are located on the bottom of this apparatus.

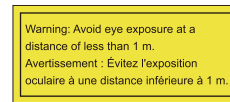

- Notice is given to supervise children and to never allow them to stare into the projector beam at any distance from the projector.
- Notice is given to use caution when using the remote control for starting the projector while in front of the projection lens.
- Notice is given to the user to avoid the use of optical aids such as binoculars or telescopes inside the beam.



Caution – Use of controls or adjustments or performance of procedures other than those specified herein may result in hazardous radiation exposure.

Introduction

Shipping contents

Carefully unpack and verify that you have all of the items shown below. If any of these items are missing, please contact your place of purchase.

Standard accessories

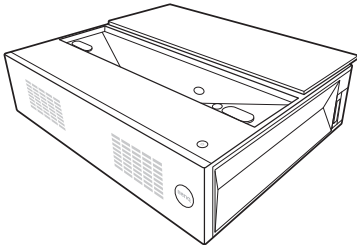

Projector

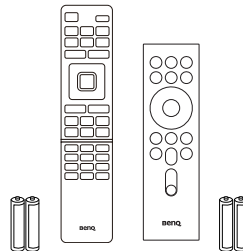

Remote controls with batteries

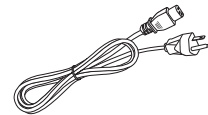

Power cord



Quick start guide



Warranty card*

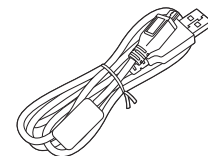

USB cable



QS01 Android TV dongle



- The supplied accessories will be suitable for your region, and may differ from those illustrated.
- *The warranty card is only supplied in some specific regions. Please consult your dealer for detailed information.

Optional accessories

- BenQ 3D glasses

Replacing the remote control batteries

1. Open the battery cover, as illustrated.
2. Remove the old batteries (if applicable) and install two AAA batteries. Make sure that the positive and negative ends are positioned correctly, as illustrated.
3. Refit the battery cover until it clicks into place.

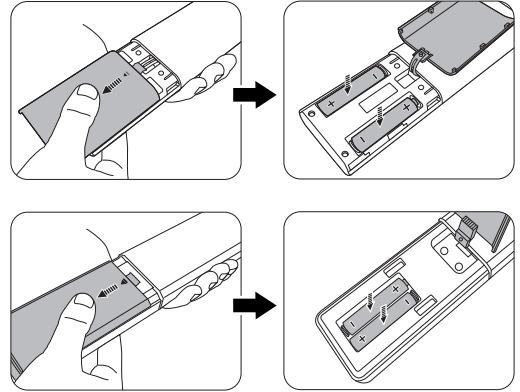

- Avoid leaving the remote control and batteries in an excessive heat or humid environment like the kitchen, bathroom, sauna, sunroom or in a closed car.
- Replace only with the same or equivalent type recommended by the battery manufacturer.
- Dispose of the used batteries according to the manufacturer's instructions and local environment regulations for your region.
- Never throw the batteries into a fire. There may be danger of an explosion.
- If the batteries are dead or if you will not be using the remote control for an extended period of time, remove the batteries to avoid damage to the remote control from possible battery leakage.

Using the positioning units

Two rulers can be pulled out from the rear of the projector to measure the projection distance between the projector and the screen, which helps you in positioning the projector.

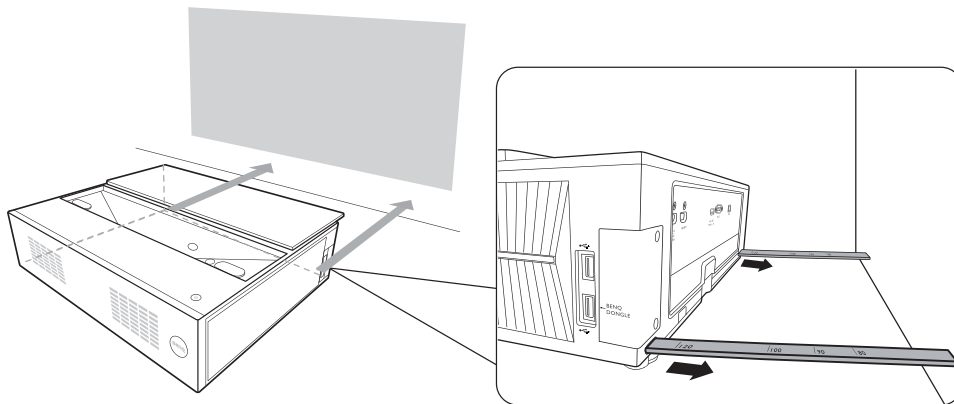

Projector exterior view

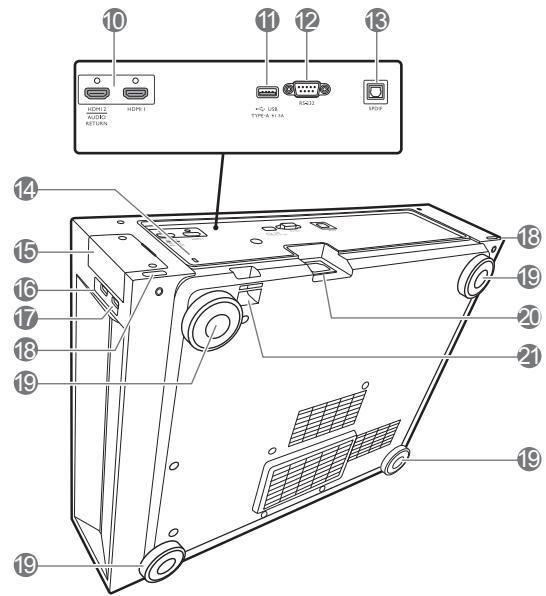
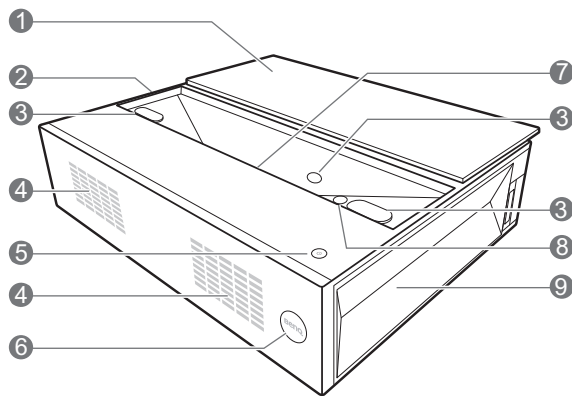

- | | |
|--|---|
| <ul style="list-style-type: none"> 1. Lens cover 2. Vent (air inlet) 3. Eye protection sensors 4. Speakers 5. POWER
Toggles the projector between standby mode and on. 6. IR remote sensor 7. Projection lens 8. LumiExpert 9. Vent (air exhaust) 10. HDMI input ports (Version 2.0a) | <ul style="list-style-type: none"> 11. USB Type-A ports (1.5 A power supply) 12. RS-232 control port 13. SPDIF audio output port 14. Kensington anti-theft lock slot 15. Wireless dongle cover 16. USB Type-A port 17. USB Type-A port (for dongle control) 18. Positioning units 19. Adjuster feet 20. AC power jack 21. Security bar |
|--|---|

Controls and functions

Remote control



All the key presses described in this document are available on the remote control.

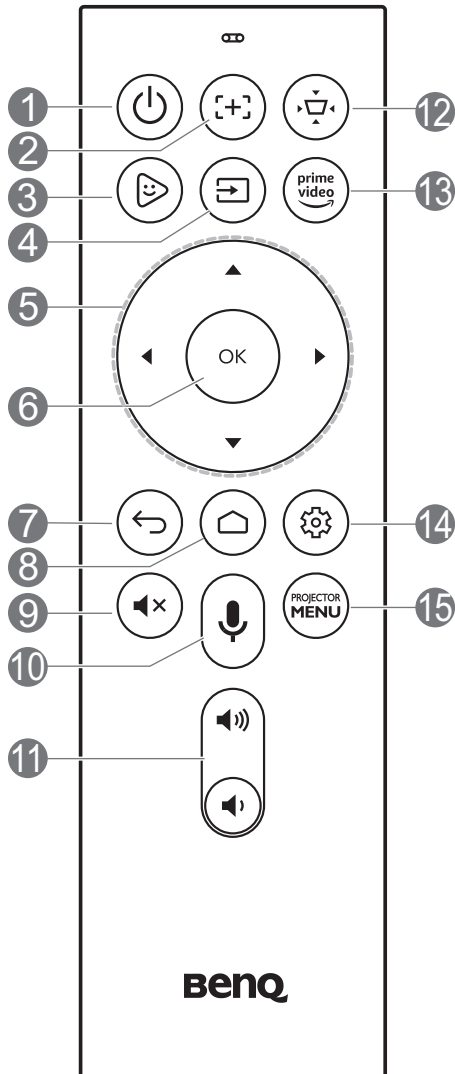

- 1. POWER**
Toggles the projector between standby mode and on.
- 2. FOCUS**
Press to open **Motor Focus** page.
- 3. KIDS TV**
Under ATV source, opens “Kids TV” application.
- 4. SOURCE**
Displays the source menu.
- 5. Arrow keys (▲, ▼, ◀, ▶)**
When the On-Screen Display (OSD) or the ATV menu is activated, these keys are used as directional arrows to select the desired menu items and to make adjustments.
When OSD and ATV menu is inactive, workable under CEC-capable sources only.
- 6. OK**
 - Confirms the selected On-Screen Display (OSD) menu item.
 - Under ATV media playback, plays or pauses a video or audio file.
- 7. BACK**
Under ATV source:
 - Returns to upper level of ATV menu.
 - Closes ATV pop-up menu.
 - Leaves current ATV application.Under Projector OSD:
 - Returns to upper level or close the OSD menu.
 - Closes OSD pop-up menu.
- 8. ANDROID TV HOME**
Opens ATV Home page.
- 9. MUTE**
Toggles projector audio between on and off.

10.  **VOICE SEARCH / ASSISTANT**

Press and hold to activate the voice assistant or voice search. Hold this key and speak to the microphone at the top of the remote control while using voice assistant.

11. **Volume keys (, )**

Decreases or increases the projector volume.

12.  **KEYSTONE**

Displays the keystone menu.

13.  **AMAZON PRIME VIDEO**

Under ATV source, opens “Amazon Prime Video” application.

14.  **ANDROID SETTING**

Displays Android setting option.

15.  **PROJECTOR MENU**

Opens/Closes projector OSD menu.

Remote control



All the key presses described in this document are available on the remote control.

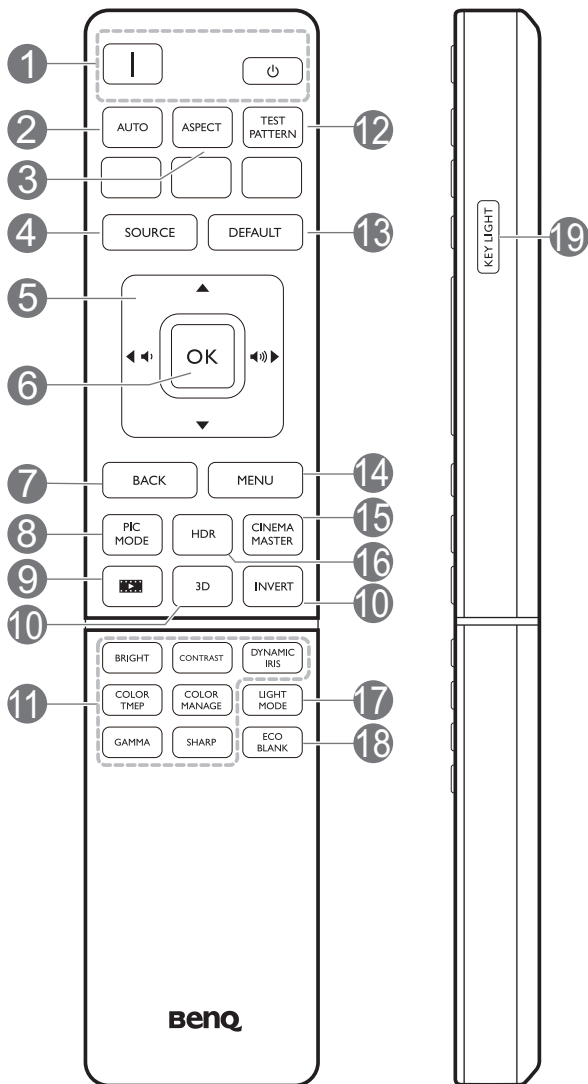

1. / **POWER**

Toggles the projector between standby mode and on.

2. **AUTO**

The key function is not available with this model.

3. **ASPECT**

Selects the display aspect ratio.

4. **SOURCE**

Displays the source selection bar.

5. **Volume keys** (,)

Decreases or increases the projector volume.

Arrow keys (, , ,)

When the On-Screen Display (OSD) menu is activated, these keys are used as directional arrows to select the desired menu items and to make adjustments.

6. **OK**

Confirms the selected On-Screen Display (OSD) menu item.

7. **BACK**

Goes back to previous OSD menu, exits and saves menu settings.

8. **PIC MODE**

Selects an available picture setup mode.

9. **FILMMAKER MODE**

Selects the **FILMMAKER MODE**.

10. **3D/INVERT**

Displays the **3D** menu.

11. **Picture quality adjustment keys** (**BRIGHT**, **CONTRAST**, **COLOR TEMP**, **COLOR MANAGE**, **GAMMA**, **SHARP**) (**DYNAMIC IRIS** is not supported with this model)

Displays the setting bars for adjustments of the appropriate picture quality values.

12. **TEST PATTERN**

Displays the test pattern.

13. **DEFAULT**

Resets the current function to default factory setting.

14. **MENU**

Turns on the On-Screen Display (OSD) menu.

15. **CINEMAMASTER**

Displays the **CinemaMaster** menu. See [CinemaMaster on page 34](#).

16. **HDR**

Displays the **HDR** menu. See [HDR on page 36](#).

17. **LIGHT MODE**

Selects a suitable light source power from among the provided modes.

18. **ECO BLANK**

Used to hide the screen picture.



Do not block the projection lens from projecting as this could cause the blocking object to become heated and deformed or even cause a fire.

19. **KEY LIGHT**

Turns on the remote control backlight for a few seconds. To keep the backlight on, press any other key while the backlight is on. Press the key again to turn the backlight off.

Remote control effective range

The remote control must be held at an angle within 30 degrees perpendicular to the projector's IR remote control sensor(s) to function correctly. The distance between the remote control and the sensor(s) should not exceed 8 meters (~ 26 feet).

Make sure that there are no obstacles between the remote control and the IR sensor(s) on the projector that might obstruct the infra-red beam.

- Operating the projector from the front

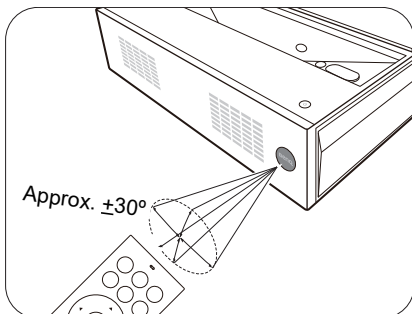

Positioning your projector

Obtaining a preferred projected image size

The distance from the projector lens to the screen, the zoom setting, and the video format each factors in the projected image size.

Projection dimensions

- The screen aspect ratio is 16:9 and the projected picture is in a 16:9 aspect ratio

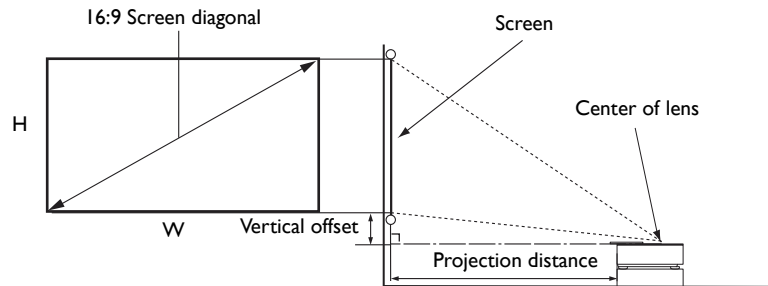

image size				Projection distance (mm)	Vertical offset (mm)
Diagonal		W (mm)	H (mm)		
Inch	mm				
70	1778	1550	872	73	160
80	2032	1771	996	120	191
90	2286	1992	1121	176	221
95	2413	2103	1183	200	236
100	2540	2214	1245	222	252
120	3048	2657	1494	331	313

For example, if you are using a 120-inch screen, the recommended projection distance is 331 mm.

If your measured projection distance is 230 mm, the closest match in the "Projection distance (mm)" column is 222 mm. Looking across this row shows that a 100" (about 2.5 m) screen is required.



All measurements are approximate and may vary from the actual sizes.

BenQ recommends that if you intend to permanently install the projector, you should physically test the projection size and distance using the actual projector in situ before you permanently install it, so as to make allowance for this projector's optical characteristics. This will help you determine the exact mounting position so that it best suits your installation location. The distance between the ambient light reflection screen and the projector should also be considered during installation.

Adjusting the projected image

Adjusting the projection angle

If the projector is not placed on a flat surface or the screen and the projector are not perpendicular to each other, the projected image becomes trapezoidal. You can screw the adjuster feet to fine-tune the horizontal angle.

To retract the feet, screw the adjuster feet in a reverse direction.

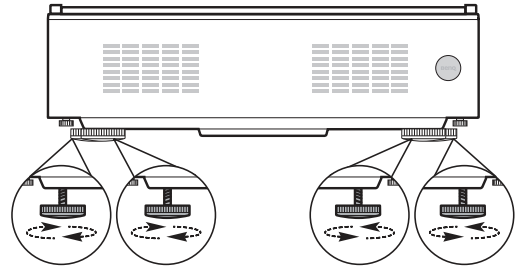

! Do not look into the lens while the light source is on. The strong light from the light source may cause damage to your eyes.

Fine-tuning the image clarity

Go to **INSTALLATION > Motor Focus** and use **◀/▶** to adjust the focus settings.

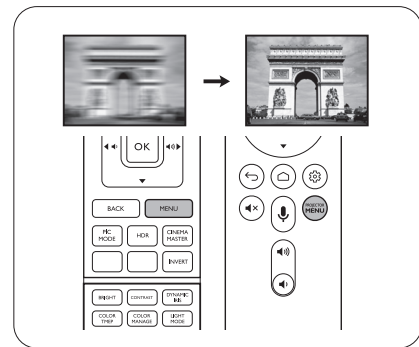

Correcting keystone

Keystoning refers to the situation where the projected image becomes a trapezoid due to angled projection.

To automatically correct this, enable **Auto Keystone** in the **INSTALLATION** menu.

To manually correct this:

1. Press **KEYSTONE** on the remote control or go to **INSTALLATION > Keystone**.
2. Press **▲/▼** on the remote control.
3. After the **Keystone** correction page appears, press **▼** to correct keystone at the top of the image. Press **▲** to correct keystone at the bottom of the image.

When done, press **BACK** to save and exit.

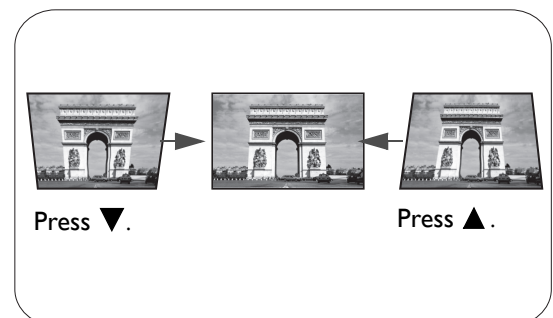

Connection

When connecting a signal source to the projector, be sure to:

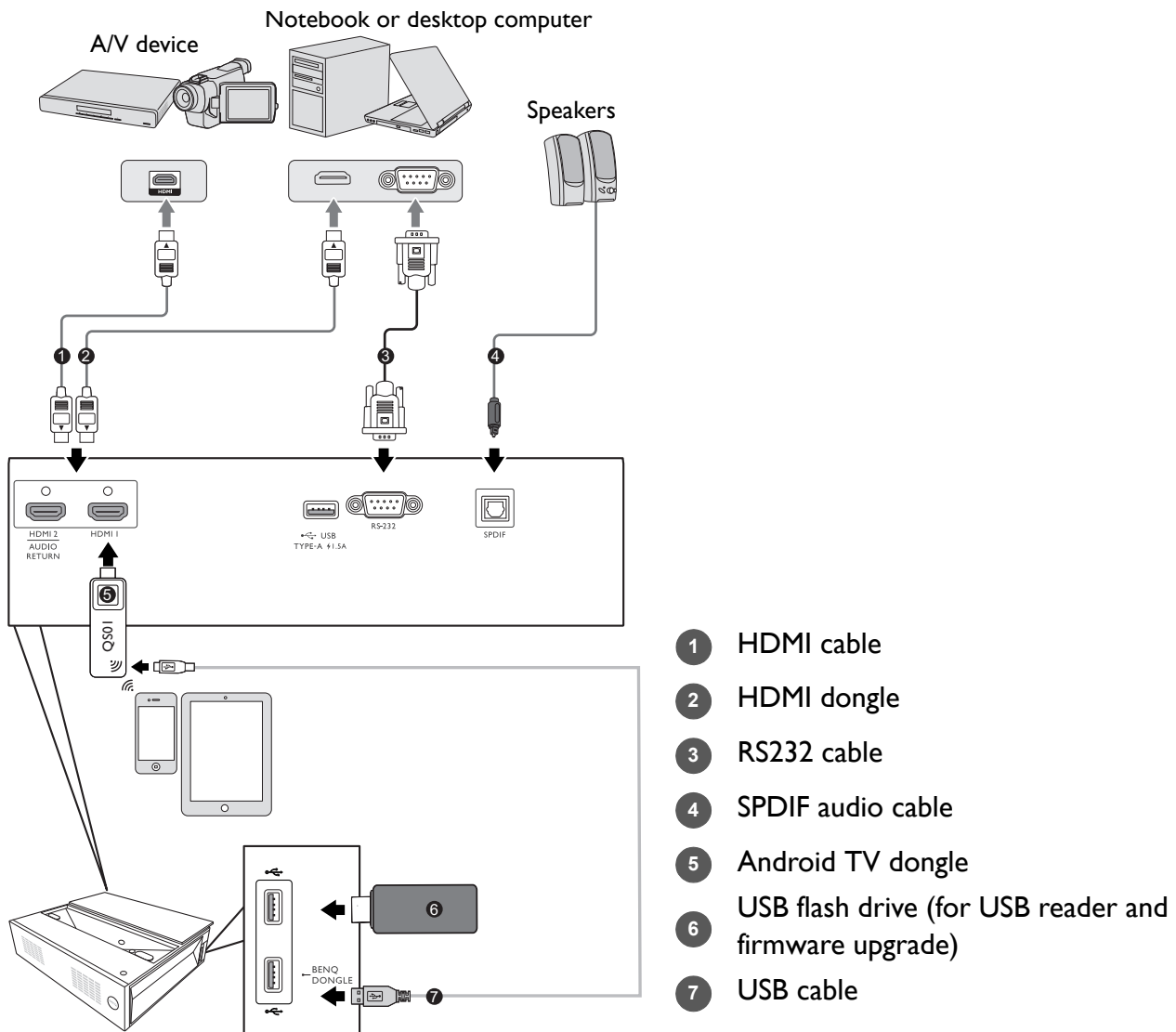

1. Turn all equipment off before making any connections.
2. Use the correct signal cables for each source.
3. Ensure the cables are firmly inserted.



- In the connections above, some cables may not be included with the projector (see [Shipping contents on page 8](#)). They are commercially available from electronics stores.
- The connection illustrations are for reference only. The rear connecting jacks available on the projector vary with each projector model.
- Many notebooks do not turn on their external video ports when connected to a projector. Usually a key combo like FN + function key, or Windows + F9 with a monitor symbol turns the external display on/off. Press FN and the labeled function key simultaneously. Refer to your notebook's documentation to find your notebook's key combination.
- If the selected video image is not displayed after the projector is turned on and the correct video source has been selected, check that the video source device is turned on and operating correctly. Also check that the signal cables have been connected correctly.





Operation

Starting up the projector

1. Plug the power cord. Turn on the power outlet switch (where fitted). The power indicator on the projector lights blue after power has been applied.
2. Press  on the projector or  on the remote control to start the projector. The power indicator flashes blue and stays white when the projector is on.

The start up procedure takes about 30 seconds. In the later stage of starting up, a start-up logo is projected.

3. If this is the first time you turn on the projector, the setup wizard appears to guide you through setting up the projector. If you have already done this, skip this step and move on to the next step.

- Use the arrow keys () on the remote control to move through the menu items.
- Use **OK** to confirm the selected menu item.

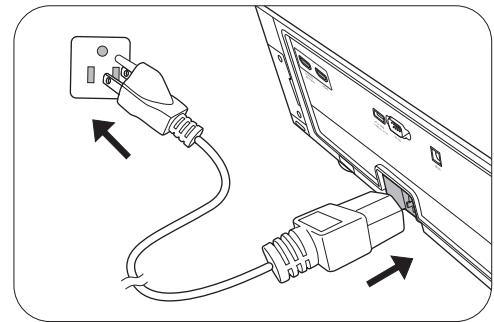

Step 1:

Specify **Projector Position**.

For more information about projector position, see [Obtaining a preferred projected image size](#).

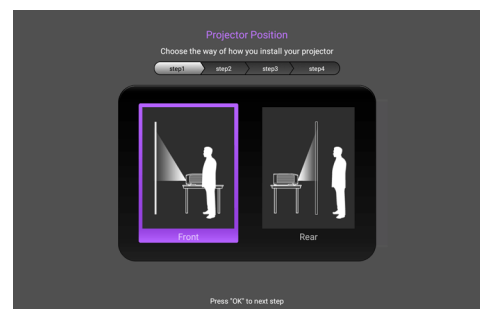

Step 2:

Specify OSD **Language**.

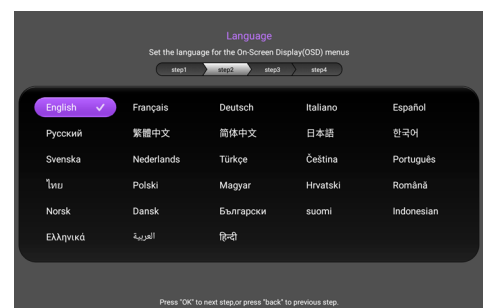

Step 3:

Reminds you to insert the ATV dongle.

Press **OK** to dismiss the message, or long press on **BACK** for 2 seconds to dismiss it for good.

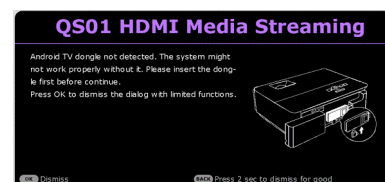

Step 4:

Specify **Keystone**.

For more information about keystone, see [Correcting keystone](#).

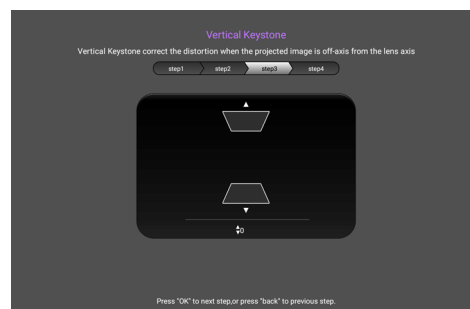

Step 5:

Specify **Auto Source**.

Select **On** if you want the projector to always search for available signals automatically when the projector is turned on.

Now you've completed the initial setup.

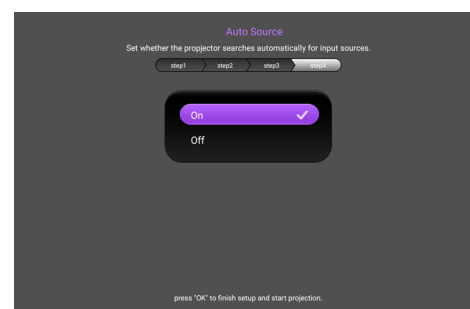

4. Switch all of the connected equipment on.

5. You can also press  **SOURCE** to select your desired input signal. See [Switching input signal on page 24](#).



- Please use the original accessories (e.g. power cord) to avoid possible dangers such as electric shock and fire.
- If the projector is still hot from previous activity, it will run the cooling fan for approximately 90 seconds before energizing the light source.



- The Setup Wizard screenshots are for reference only and may differ from the actual design.
- If the frequency/resolution of the input signal exceeds the projector's operating range, you will see the message "Out of Range" displayed on the background screen. Please change to an input signal which is compatible with the projector's resolution or set the input signal to a lower setting. See [Timing chart on page 47](#).
- If no signal is detected for 3 minutes, the projector automatically enters saving mode.

QS01 Android TV setup

Before you start

Check that you have:

- A Wi-Fi Internet connection
- A Google Account

Step 1: Press and hold **OK for 3 seconds to pair your remote control**

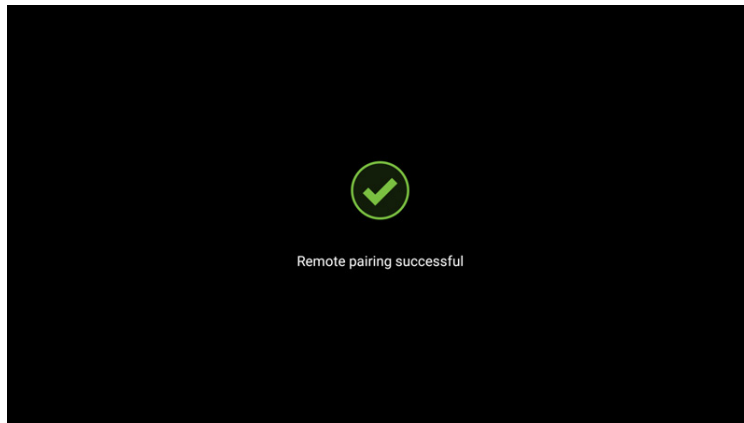
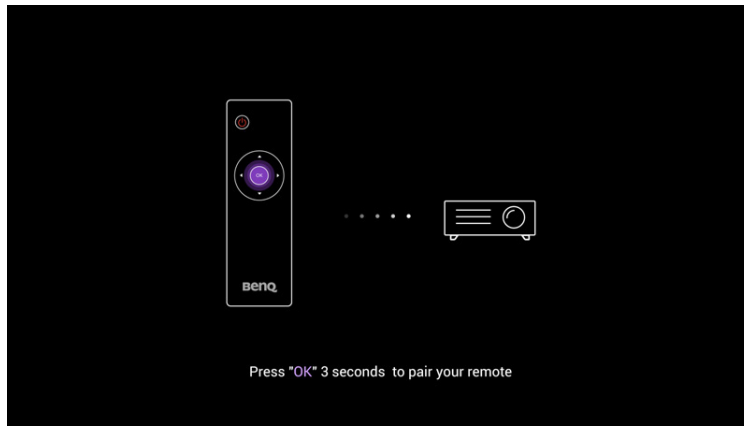

Step 2: Set up your device

There are 3 options to set up your device:

- Quick Setup using an Android phone

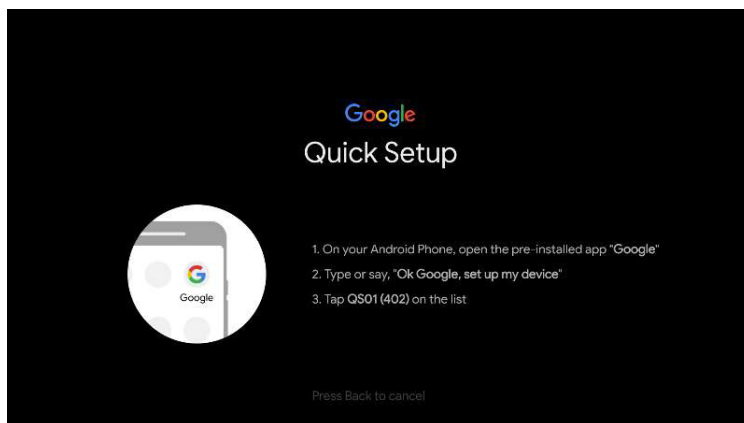

- Using your phone or computer

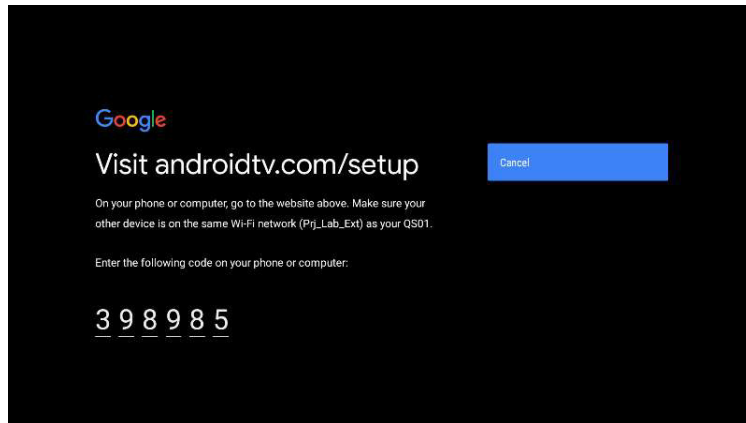

- Using your remote control

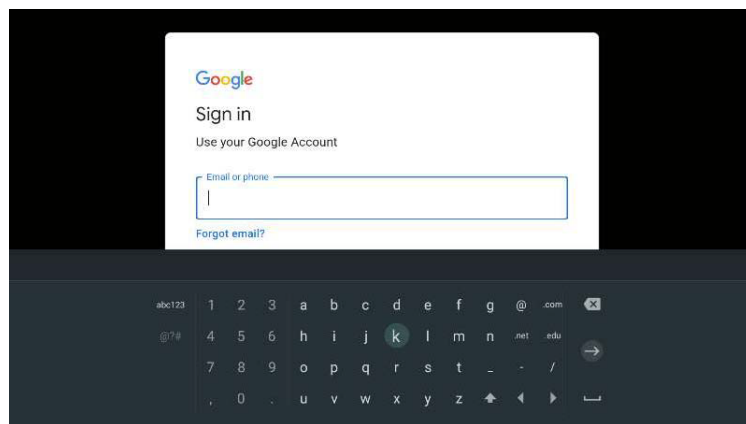

Step 3: Display Android TV home screen

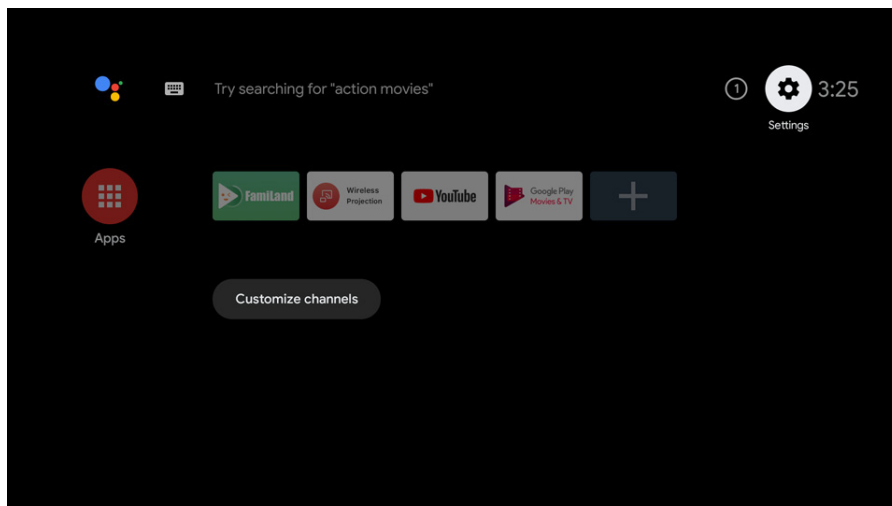

 For more information, visit <https://support.google.com/androidtv/>

Using the menus

The projector is equipped with On-Screen Display (OSD) menus for making various adjustments and settings.



The OSD screenshots below are for reference only, and may differ from the actual design.

Below is the overview of the OSD menu.

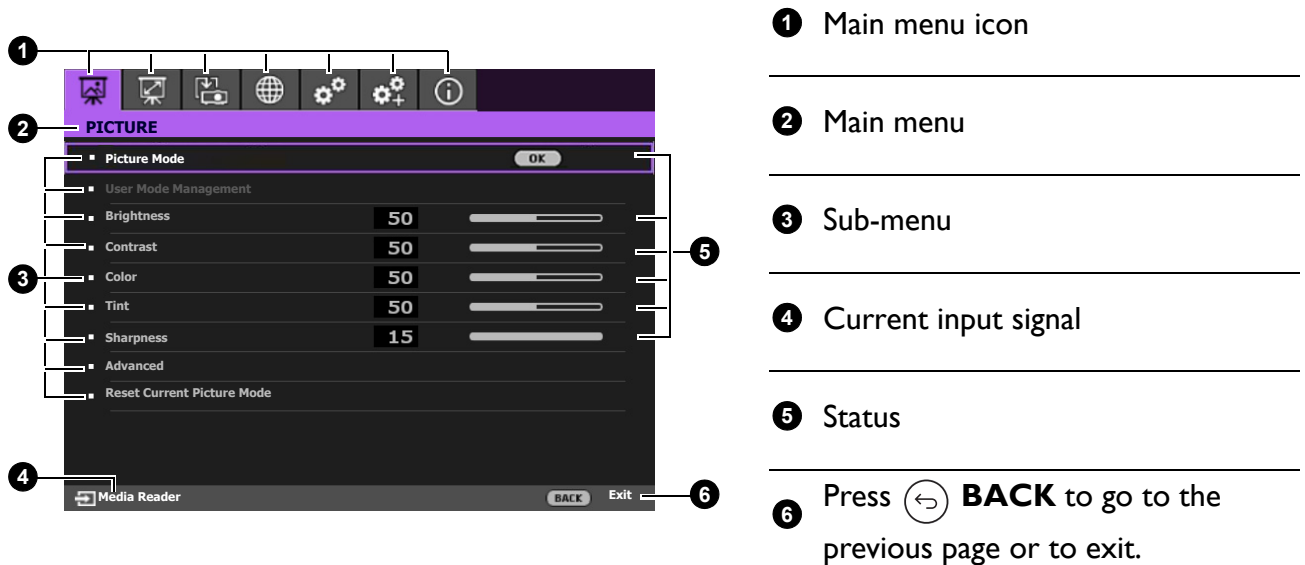

To access this home screen, press **PROJECTOR MENU** on the remote control.

- Use the arrow keys (**▲/▼/◀/▶**) on the remote control to move through the menu items.
- Use **OK** on the remote control to confirm the selected menu item.

Securing the projector

Using a security cable lock

The projector has to be installed in a safe place to prevent theft. Otherwise, purchase a security cable to secure the projector. A security bar is located on the right side of the projector. See item 14 on [page 10](#). Insert a security cable to the opening of the security bar and secure it to a nearby fixture or heavy furniture.

Utilizing the password function

Setting a password

1. Go to **SYSTEM SETUP: ADVANCED > Password**. Press **OK**. The **PASSWORD** page appears.
2. Highlight **Change Password** and press **OK**.

3. The four arrow keys (▲, ►, ▼, ◀) respectively represent 4 digits (1, 2, 3, 4). According to the password you desire to set, press the arrow keys to enter six digits for the password.

4. Confirm the new password by re-entering the new password.
Once the password is set, the OSD menu returns to the **PASSWORD** page.

5. To activate the **Power On Lock** function, press ▲/▼ to highlight **Power On Lock** and press ◀/▶ to select **On**. Input the password again.

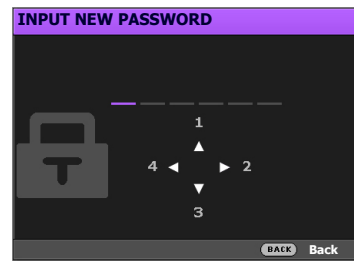

- The digits being input will be displayed as asterisks on-screen. Make a note of your selected password and keep it in a safe place in advance or right after the password is entered so that it is available to you should you ever forget it.
- Once a password has been set and the power on lock is activated, the projector cannot be used unless the correct password is entered every time the projector is started.

If you forget the password

If you enter the wrong password, the password error message will appear, and the **INPUT CURRENT PASSWORD** message follows. If you absolutely do not remember the password, you can use the password recall procedure. See [Entering the password recall procedure on page 23](#).

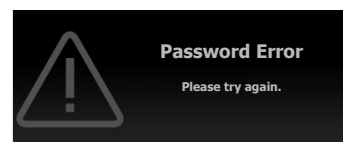

If you enter an incorrect password 5 times in succession, the projector will automatically shut down in a short time.

Entering the password recall procedure

1. Press and hold **OK** for 3 seconds. The projector will display a coded number on the screen.
2. Write down the number and turn off your projector.
3. Seek help from the local BenQ service center to decode the number. You may be required to provide proof of purchase documentation to verify that you are an authorized user of the projector.

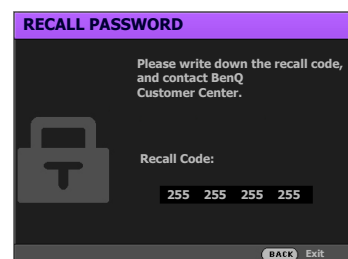

Changing the password

1. Go to **SYSTEM SETUP: ADVANCED > Password > Change Password**.
2. Press **OK**. The **INPUT CURRENT PASSWORD** message appears.
3. Enter the old password.
 - If the password is correct, another message **INPUT NEW PASSWORD** appears.
 - If the password is incorrect, the password error message will appear, and the message **INPUT CURRENT PASSWORD** appears for your retry. You can press (↶) **BACK** to cancel the change or try another password.
4. Enter a new password.
5. Confirm the new password by re-entering the new password.

Disabling the password function

To disable password protection, go to **SYSTEM SETUP: ADVANCED > Password > Power On Lock** and press ◀/▶ to select **Off**. The message **INPUT CURRENT PASSWORD** appears. Enter the current password.

- If the password is correct, the OSD menu returns to the **PASSWORD** page. You will not have to enter the password next time turning on the projector.
- If the password is incorrect, the password error message will appear, and the message **INPUT CURRENT PASSWORD** appears for your retry. You can press ⏪ **BACK** to cancel the change or try another password.



Though the password function is disabled, you need to keep the old password in hand should you ever need to re-activate the password function by entering the old password.

Switching input signal

The projector can be connected to multiple devices at the same time. However, it can only display one full screen at a time. When starting up, the projector automatically searches for the available signals.

Be sure the **SYSTEM SETUP: BASIC > Auto Source** menu is **On** if you want the projector to automatically search for the signals.

To select the source:

1. Press ⏪ **SOURCE**. A source selection bar appears.
2. Press ▲/▼ until your desired signal is selected and press **OK**.

Once detected, the picture from the selected source will appear. If there is multiple equipment connected to the projector, repeat steps 1-2 to search for another signal.

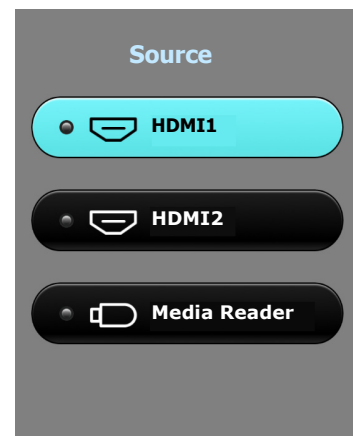

- The brightness level of the projected image will change accordingly when you switch between different input signals.
- For best display picture results, you should select and use an input signal which outputs at the projector's native resolution. Any other resolutions will be scaled by the projector depending upon the "aspect ratio" setting, which may cause some image distortion or loss of picture clarity.





Presenting from a USB flash drive

The USB Type-A ports on the projector allow you to browse the image and document files stored on a USB flash drive connected to the projector. It can eliminate the need for a computer source.

Supported file formats

Video format	Audio format	Photo format
<ul style="list-style-type: none">• MPEG1• MPEG4• H.263• H.264• H.265• Motion JPEG	<ul style="list-style-type: none">• MPEG 1/2 Layer1• MPEG 1/2 Layer2• FLAC• MP3	<ul style="list-style-type: none">• JPEG Base-line• JPEG Progressive• PNG non-interlace• PNG interlace• BMP

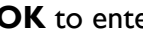
Viewing files



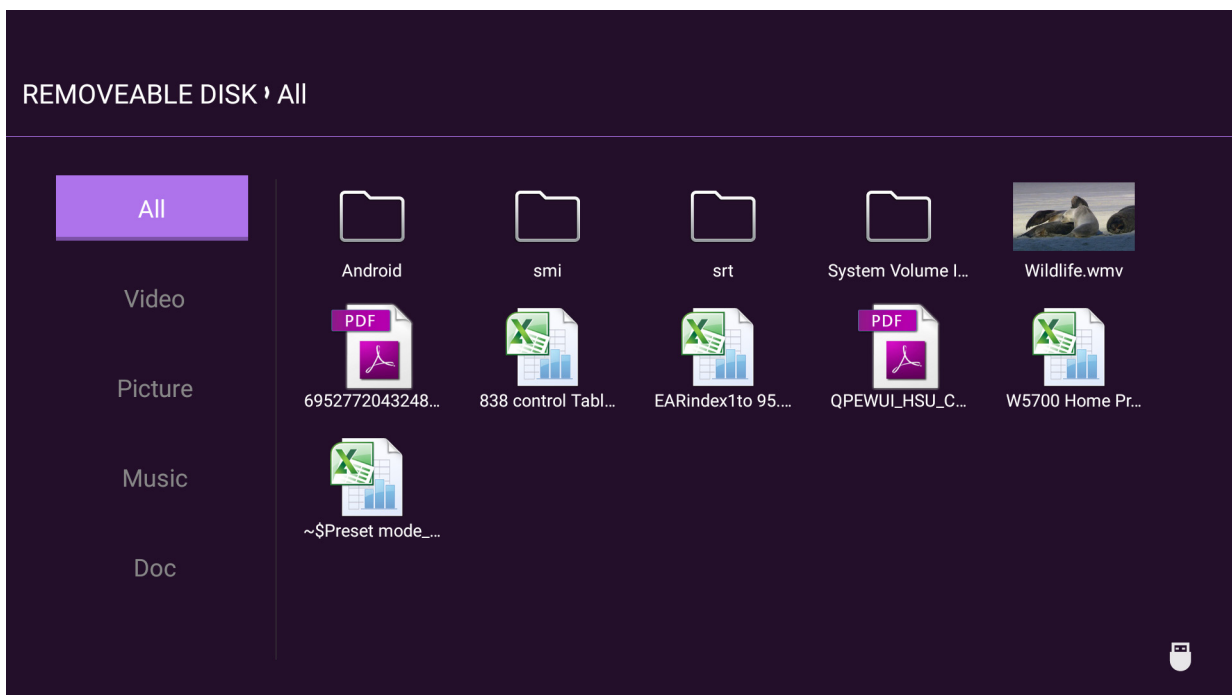















1. Plug a USB flash drive into the upper USB port on the left side of the projector.
2. Press  **SOURCE** and select **Media Reader**. The projector displays the built in media reader main page.
3. Press  to select and press **OK** to enter the sub-folder or display a file.
4. After a file is displayed, press **OK** and  to perform further actions, or press  **BACK** to return to the previous page.



























• Button functions for viewing video clips

Button	Description
OK	Plays/Pauses the video.
▲/▼	Cycles through the video clips.
◀/▶	Rewinds/Fast-forwards the video.
 BACK	Goes back to the thumbnail page.

• Button functions for viewing pictures

Button	Description										
OK	<p>1. Calls out the function menu.</p> <p>2. When the following items are highlighted, press OK to enable their functions.</p> <table border="1" data-bbox="365 728 1437 1086"> <tbody> <tr> <td> Slide show</td> <td>Sets the way to display all the pictures in the same folder by using ▲/▼/◀/▶.</td> </tr> <tr> <td> Rotate Photo</td> <td>Rotate the picture in a clockwise direction.</td> </tr> <tr> <td> Resize Photo</td> <td>Enlarges the picture. To restore its original size, press  BACK.</td> </tr> <tr> <td> Previous</td> <td>Goes to the previous picture.</td> </tr> <tr> <td> Next</td> <td>Goes to the next picture.</td> </tr> </tbody> </table>	 Slide show	Sets the way to display all the pictures in the same folder by using ▲/▼/◀/▶.	 Rotate Photo	Rotate the picture in a clockwise direction.	 Resize Photo	Enlarges the picture. To restore its original size, press  BACK .	 Previous	Goes to the previous picture.	 Next	Goes to the next picture.
 Slide show	Sets the way to display all the pictures in the same folder by using ▲/▼/◀/▶.										
 Rotate Photo	Rotate the picture in a clockwise direction.										
 Resize Photo	Enlarges the picture. To restore its original size, press  BACK .										
 Previous	Goes to the previous picture.										
 Next	Goes to the next picture.										
 BACK	Goes back to the thumbnail page.										



• Button functions for playing music

Button	Description					
OK	<p>When the following items are highlighted, press OK to enable their functions.</p> <table border="1" data-bbox="365 1384 1437 1758"> <tbody> <tr> <td> Shows the play list. To select a song from the list, use ▲/▼. Press  BACK to dismiss the play list.</td> </tr> <tr> <td> Goes to the previous song.</td> </tr> <tr> <td> Goes to the next song.</td> </tr> <tr> <td> Plays/Pauses the music</td> </tr> <tr> <td>   Sets the way how the music is played, eg. Plays, Single Play, Random.</td> </tr> </tbody> </table>	 Shows the play list. To select a song from the list, use ▲/▼. Press  BACK to dismiss the play list.	 Goes to the previous song.	 Goes to the next song.	 Plays/Pauses the music	   Sets the way how the music is played, eg. Plays, Single Play, Random.
 Shows the play list. To select a song from the list, use ▲/▼. Press  BACK to dismiss the play list.						
 Goes to the previous song.						
 Goes to the next song.						
 Plays/Pauses the music						
   Sets the way how the music is played, eg. Plays, Single Play, Random.						
 BACK	Goes back to the thumbnail page.					

- Button functions for viewing documents

Button	Description
▲/▼	<p>Scrolls up or down the page.</p> <p>When displaying PowerPoint files, follow the on-screen display to set the way to show the pages.</p>

Shutting down the projector

1. Press  and a confirmation message will appear prompting you. If you don't respond in a few seconds, the message will disappear.
2. Press  a second time. The power indicator flashes white, the projection light source shuts down.
3. Once the cooling process finishes, the power indicator becomes a steady blue and fans stop. Disconnect the power cord from the power outlet.

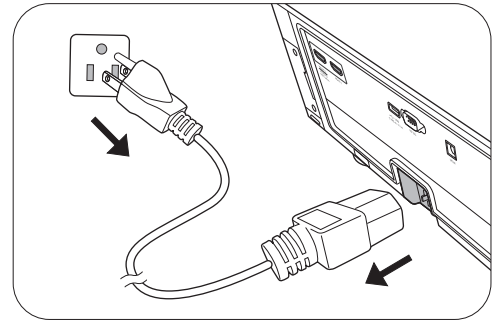

- To protect the light source, the projector will not respond to any commands during the cooling process.
- Avoid turning on the projector immediately after turning it off as excessive heat may shorten light source life.
- Light source life results will vary depending on environmental conditions and usage.

Menu operation

Menu system

Please note that the on-screen display (OSD) menus vary according to the signal type selected and the projector model you are using.

The menu items are available when the projector detects at least one valid signal. If there is no equipment connected to the projector or no signal detected, limited menu items are accessible.

Main menu	Sub-menu	Options	
PICTURE	Picture Mode	Bright/Living Room/FILMMAKER MODE/DCI-P3/User/Silence/3D/FILMMAKER MODE/HLG	
	User Mode Management	Load Settings From Rename User Mode	
	Brightness	0–100	
	Contrast	0–100	
	Color	0–100	
	Tint	0–100	
	Sharpness	0–15	
		Gamma Selection	1.8/2.0/2.1/2.2/2.3/2.4/2.5/2.6/ BenQ
		HDR Brightness	-2 – +2
		Color Temperature	Preset/Red Gain/Green Gain/Blue Gain/Red Offset/Green Offset/Blue Offset
		Color Management	Primary Color/Hue/Saturation/Gain
	Advanced	CinemaMaster	Color Enhancer/Flesh Tone/Pixel Enhancer 4K/Motion Enhancer 4K
		Noise Reduction	Low/Middle/High/Off
		Brilliant Color	0–10
		Wide Color Gamut	On/Off
		LumiExpert	On/Off Level
		Light Mode	Normal/Economic/SmartEco
	Reset Current Picture Mode	Reset/Cancel	
DISPLAY	Overscan Adjustment	0–3	
	3D	3D Mode 3D Sync Invert	
	HDR	Auto/Off	
	Silence	On/Off	

Main menu	Sub-menu	Options	
INSTALLATION	Projector Position	Front/Rear	
	Motor Focus		
	Test Pattern	On/Off	
	Aspect Ratio	Auto/4:3/16:9	
	High Altitude Mode	On/Off	
	Auto Keystone	On/Off	
	Keystone		
SYSTEM SETUP: BASIC	Language	العربية/Български/Hrvatski/ Čeština/Dansk/Nederlands/English/ Suomi/Français/Deutsch/Ελληνικά/ हिंदी /Magyar/Italiano/Indonesian/ 日本語 / 한국어 /Norsk/Polски/ Português/Română/Русский/ 简体中文 /Español/Svenska/Türkçe/ไทย/ 繁體中文	
	Background Color	Black/Blue/Purple	
	Splash Screen	BenQ/Black/Blue	
	Auto Off	Disable/5 min/10 min/15 min/20 min/25 min/30 min	
	Direct Power On	On/Off	
	Menu Settings	Menu Position	Center/Top-Left/Top-Right/Bottom-Right/Bottom-Left
		Menu Display Time	Always On/5 sec/10 sec/15 sec/20 sec/25 sec/30 sec
		Reminder Message	On/Off
	Source Rename		
	Auto Source	On/Off	
	Sound	Sound Mode	Effect Mode
			User EQ
		Mute	On/Off
		Volume	
		Power On/Off	On/Off
		Ring Tone	On/Off
		Reset Audio Settings	Reset/Cancel
		Speaker	On/Off
		Audio Return(HDMI-2)	On/Off
		SPDIF	On/Off
Eye Protection	On/Off		

Main menu	Sub-menu	Options	
SYSTEM SETUP: ADVANCED	Light Source Settings	Light Source Timer	
	HDMI Settings	HDMI Format	Auto/RGB Limited/RGB Full/YUV
		HDMI Equalizer	
		HDMI EDID	
		Electronic Control	On/Off
		Power On Link	Off/From Device
		Power Off Link	Off/From Projector
		Change Password	
	Password	Power On Lock On/Off	
	Key Lock	On/Off	
	LED Indicator	On/Off	
	Reset All Settings	Reset/Cancel	
	INFORMATION	Source	
		Picture Mode	
Dynamic Range			
Resolution			
Color System			
Light Usage Time			
3D Format			
Firmware Version			
Service Code			

PICTURE menu

<p>Picture Mode</p>	<p>The projector is preset with several predefined picture modes so that you can choose one to suit your operating environment and input signal picture type.</p> <ul style="list-style-type: none">• Bright: Maximizes the brightness of the projected image. This mode is suitable for environments where extra-high brightness is required, such as using the projector in well lit rooms.• Living Room: With well-saturated color, fine-tuned sharpness, and a higher brightness level, this mode is suitable for playing movies in rooms where there is a small amount of ambient light, e.g. your living room.• FILMMAKER MODE: This mode is best for watching movies with accurate color and deepest contrast at lower brightness level in rooms with a bit of ambient light, as if in a commercial cinema.• DCI-P3: In accordance with 100% DCI-P3 color gamut, this mode provides deepest contrast at lower brightness level. It is suitable for playing 4K SDR movies in a totally dark environment, as if in a commercial cinema.• User: Recalls the settings customized based on the current available picture modes. See User Mode Management on page 32.• Silence: Minimizes the acoustic noise. It is suitable for the need of watching movies that requires an ultra-quiet environment so that you won't be disturbed by the noise of the projector. This mode is only available when the DISPLAY > Silence menu is set at On.• 3D: Optimized to bring up 3D effects when watching 3D contents. <p></p> <p>This mode is only available when 3D function is enabled.</p> <ul style="list-style-type: none">• HDR10/FILMMAKER MODE/HLG: Delivers High Dynamic Range effects with higher contrasts of brightness and colors. This mode is best for watching 4K Blu-ray HDR10 or HLG streaming contents with 100% Rec. 709 color gamut. Picture Mode will be switched to FILMMAKER MODE/HLG automatically while detecting metadata or EOTF info from 4K Blu-ray HDR10 or HLG streaming contents.<ul style="list-style-type: none">• This mode is only available when DISPLAY > HDR is set at Auto, and HDR content is detected.• Color gamut can be enlarged to 100% DCI-P3 in the FILMMAKER MODE/HLG mode for more accurate color reproduction. Turn on Wide Color Gamut under the PICTURE > Advanced menu.
----------------------------	--

<p>User Mode Management</p>	<p>There is one user-definable mode if the current available picture modes are not suitable for your need. You can use one of the picture modes (except the User) as a starting point and customize the settings.</p> <p>• Load Settings From</p> <ol style="list-style-type: none"> 1. Go to PICTURE > Picture Mode. 2. Press ◀/▶ to select User. 3. Press ▼ to highlight User Mode Management, and press OK. The User Mode Management page is displayed. 4. Select Load Settings From and press OK. 5. Press ▲/▼ to select a picture mode that is closest to your need. 6. Press OK and ⏪ BACK to return to the PICTURE menu. 7. Press ▼ to select the sub-menu items you want to change and adjust the values with ◀/▶. The adjustments define the selected user mode. <p>• Rename User Mode</p> <p>Select to rename the customized picture mode (User). The new name can be up to 9 characters including English letters (A-Z, a-z), digits (0-9), and space ().</p> <ol style="list-style-type: none"> 1. Go to PICTURE > Picture Mode. 2. Press ◀/▶ to select User. 3. Press ▼ to highlight User Mode Management, and press OK. The User Mode Management page is displayed. 4. Press ▼ to highlight Rename User Mode and press OK. The Rename User Mode page is displayed. 5. Use ▲/▼/◀/▶, and OK to set desired characters. 6. When done, press ⏪ BACK to save the changes and exit.
<p>Brightness</p>	<p>The higher the value, the brighter the image. Adjust this control so the black areas of the image appear just as black and that detail in the dark areas is visible.</p>
<p>Contrast</p>	<p>The higher the value, the greater the contrast. Use this to set the peak white level after you have previously adjusted the Brightness setting to suit your selected input and viewing environment.</p>
<p>Color</p>	<p>Lower setting produces less saturated colors. If the setting is too high, colors on the image will be overpowering, which makes the image unrealistic.</p>
<p>Tint</p>	<p>The higher the value, the more greenish the picture becomes. The lower the value, the more reddish the picture becomes.</p>
<p>Sharpness</p>	<p>The higher the value, the sharper the picture becomes.</p>

Advanced

• Gamma Selection

Gamma refers to the relationship between input source and picture brightness.

- **1.8/2.0/2.1/BenQ**: Select these values according to your preference.
- **2.2/2.3**: Increases the average brightness of the picture. Best for a lit environment, meeting room or family room.
- **2.4/2.5**: Best for viewing movies in a dark environment.
- **2.6**: Best for viewing movies which are mostly composed of dark scenes.

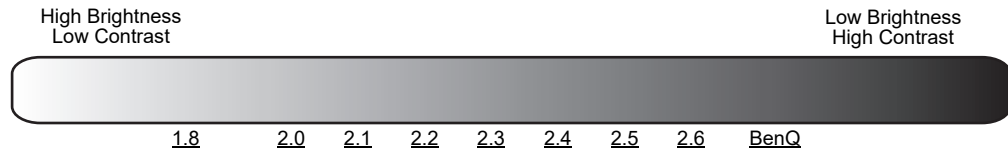

• HDR Brightness

The projector can automatically adjust the brightness levels of your image according to the input source. You can also manually select a brightness level to display better picture quality. When the value is higher, the image becomes brighter; when the value is lower, the image becomes darker.

• Color Temperature

There are several preset color temperature settings available. The available settings may vary according to the signal type selected.

- **Normal**: Maintains normal colorings for white.
- **Cool**: Makes images appear bluish white.
- **Lamp Native**: With the light source's original color temperature and higher brightness. This setting is suitable for environments where high brightness is required, such as projecting pictures in well lit rooms.
- **Warm**: Makes images appear reddish white.

You can also set a preferred color temperature by adjusting the following options.

- **Red Gain/Green Gain/Blue Gain**: Adjusts the contrast levels of Red, Green, and Blue.
- **Red Offset/Green Offset/Blue Offset**: Adjusts the brightness levels of Red, Green, and Blue.

• Color Management

The Color Management provides six sets (RGBCMY) of colors to be adjusted. When you select each color, you can independently adjust its range and saturation according to your preference.

- **Primary Color:** Selects a color from among Red, Yellow, Green, Cyan, Blue, or Magenta.
- **Hue:** Increase in the range will include colors consisted of more proportions of its two adjacent colors. Please refer to the illustration for how the colors relate to each other. For example, if you select Red and set its range at 0, only pure red in the projected picture will be selected. Increasing its range will include red close to yellow and red close to magenta.
- **Saturation:** Adjusts the values to your preference. Every adjustment made will reflect to the image immediately. For example, if you select Red and set its value at 0, only the saturation of pure red will be affected.
- **Gain:** Adjusts the values to your preference. The contrast level of the primary color you select will be affected. Every adjustment made will reflect to the image immediately.

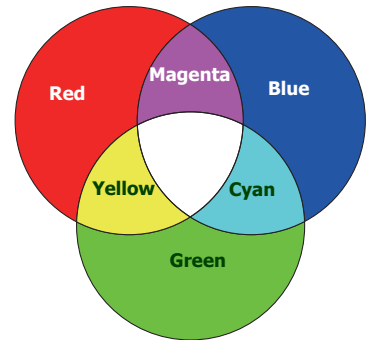

Saturation is the amount of that color in a video picture. Lower settings produce less saturated colors; a setting of “0” removes that color from the image entirely. If the saturation is too high, that color will be overpowering and unrealistic.

• CinemaMaster





- **Color Enhancer:** Allows you to fine-tune the saturation of colors with larger flexibility. It modulates complex color algorithms to flawlessly render saturated colors, fine gradients, intermediate hues and subtle pigments.
- **Flesh Tone:** Provides a smart adjustment of hue only for calibrating people's skin color, not other colors in the image. It prevents discoloration of skin tones from the light of the projection beam, portraying every skin tone in its most beautiful shade.
- **Pixel Enhancer 4K:** It is a super-resolution technology which radically enhances Full HD content in terms of colors, contrast, and textures. It's also a Detail Enhancement Technology refining surface details for true-to-life images that pop off the screen. Users can adjust levels of sharpness and detail enhancement for optimal viewing.
- **Motion Enhancer 4K:** To enhance picture smoothness by motion estimation/motion compensation.
- **Noise Reduction:** Reduces electrical image noise caused by different media players.

<p>Advanced (Continued)</p>	<ul style="list-style-type: none"> • Brilliant Color: This feature utilizes a new color-processing algorithm and system level enhancements to enable higher brightness while providing truer, more vibrant colors in picture. It enables a greater than 50% brightness increase in mid-tone images, which are common in video and natural scenes, so the projector reproduces images in realistic and true colors. If you prefer images with that quality, select from 1 to 10. When 0 is selected, the Color Temperature function is not available. • Wide Color Gamut: Color Gamut refers to the range of colors that can potentially be displayed by a device. There are some standards to define difference levels of color gamuts for display devices, such as CIE 1976, sRGB, Adobe RGB, NTSC, etc. This function is only selectable when FILMMAKER MODE HDR or HLG is selected. With this projector, selecting On will automatically apply the most suitable color gamut to the image source. It is automatically turned on when PICTURE > Picture Mode > DCI-P3 is selected. Under the rest settings, this menu is grayed out. • LumiExpert: This function adjusts the Gamma level automatically based on the ambient light detected through ALS. You can also manually adjust its value to your preference. <ul style="list-style-type: none"> • On/Off: Select to turn this function On or Off. • Level: With LumiExpert turned On, adjust the Level from -2 (dark) to 2 (bright). • Light Mode: Selects a suitable light source power from among the provided modes. See Extending light source life on page 42.
<p>Reset Current Picture Mode</p>	<p>Returns all of the adjustments you've made for the selected Picture Mode (including the preset mode, User) to the factory preset values.</p> <ol style="list-style-type: none"> 1. Press OK. The confirmation message is displayed. 2. Use ◀/▶ to select Reset and press OK. The current picture mode returns to the factory preset settings.

DISPLAY menu

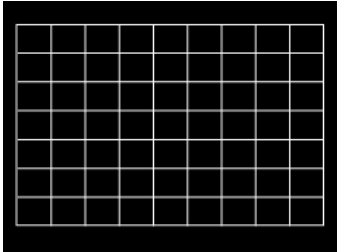
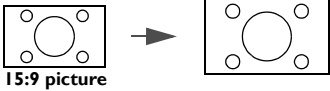

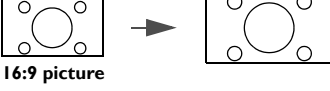
<p>Overscan Adjustment</p>	<p>Conceals the poor picture quality in the four edges.</p> <p>The greater the value, the more portion of the picture is concealed while the screen remains filled and geometrically accurate. Setting 0 means the picture is 100% displayed.</p>
<p>3D</p>	<p>This projector supports playing three-dimensional (3D) content transferred through your 3D-compatible video devices and contents, such as PlayStation consoles (with 3D game discs), 3D Blu-ray players (with 3D Blu-ray discs), and so on. After you have connected the 3D video devices to the projector, wear the BenQ 3D glasses and make sure the power is on to view 3D contents.</p> <p>When watching 3D contents:</p> <ul style="list-style-type: none"> • The image may seem misplaced; however, this is not a product malfunction. • Take appropriate breaks when watching 3D contents. • Stop watching 3D contents if you feel fatigue or discomfort. • Keep a distance from the screen of about three times the effective height of the screen. • Children and people with a history of oversensitivity to light, heart problems, or any other existing medical conditions should be refrained from watching 3D contents. • The image may seem reddish, greenish, or bluish without wearing 3D glasses. However, you will not notice any color bias when watching 3D contents with 3D glasses. • The 4K source will not be displayed. <p>• 3D Mode</p> <p>The default setting is Auto and the projector automatically chooses an appropriate 3D format when detecting 3D contents. If the projector cannot recognize the 3D format, press OK to choose a 3D mode from between Top-Bottom, and Side-by-Side.</p> <p>When this function is enabled:</p> <ul style="list-style-type: none"> • The brightness level of the projected image decreases. • The Picture Mode cannot be adjusted. <p>• 3D Sync Invert</p> <p>When your 3D image is distorted, enable this function to switch between the image for the left eye and the right eye for more comfortable 3D viewing experience.</p>
<p>HDR</p>	<p>The projector supports HDR imaging sources. It can automatically detect the dynamic range of the source, and optimize settings to reproduce contents under wider dynamic range. Meanwhile, the Picture Mode cannot be adjusted after switching to HDR.</p>
<p>Silence</p>	<p>When this function is enabled:</p> <ul style="list-style-type: none"> • The acoustic noise will be minimized. • The display resolution will be set at 1920 × 1080. • The PICTURE > Picture Mode menu will be automatically changed to Silence and grayed out.

INSTALLATION menu

Projector Position	The projector can be installed behind a screen, or with one or more mirrors. See Obtaining a preferred projected image size on page 15 .
Motor Focus	After entering this menu, use ◀/▶ to adjust the focus settings.
Test Pattern	Adjusts the image size and focus and check that the projected image is free from distortion. 
Aspect Ratio	<p>There are several options to set the image's aspect ratio depending on your input signal source.</p> <ul style="list-style-type: none"> • Auto: Scales an image proportionally to fit the projector's native resolution in its horizontal or vertical width.  • 4:3: Scales an image so that it is displayed in the center of the screen with a 4:3 aspect ratio.  • 16:9: Scales an image so that it is displayed in the center of the screen with a 16:9 aspect ratio. 
High Altitude Mode	<p>We recommend you use the High Altitude Mode when your environment is between 1500 m–3000 m above sea level, and ambient temperature is between 0°C–30°C.</p> <p>Operation under "High Altitude Mode" may cause a higher decibel operating noise level because of increased fan speed necessary to improve overall system cooling and performance.</p> <p>If you use this projector under other extreme conditions excluding the above, it may display auto shut-down symptoms, which is designed to protect your projector from over-heating. In cases like this, you should switch to High Altitude mode to solve these symptoms. However, this is not to state that this projector can operate under any and all harsh or extreme conditions.</p>  <p>Do not use the High Altitude Mode if your altitude is between 0 m and 1500 m and ambient temperature is between 0°C and 35°C. The projector will be over cooled, if you turn the mode on under such a condition.</p>
Auto Keystone	See Correcting keystone on page 16 .
Keystone	





SYSTEM SETUP: BASIC menu

Language	Sets the language for the On-Screen Display (OSD) menus.
-----------------	--

Background Color	Sets the background color for the projector.
Splash Screen	Allows you to select which logo screen will be displayed during projector start-up.
Auto Off	Allows the projector to turn off automatically if no input signal is detected after a set period of time to prevent unnecessary waste of light source life.
Direct Power On	Allows the projector to turn on automatically once the power is fed through the power cord.
Menu Settings	<ul style="list-style-type: none"> • Menu Position: Sets the On-Screen Display (OSD) menu position. • Menu Display Time: Sets the length of time the OSD will remain active after your last key press. • Reminder Message: Sets the reminder messages on or off.
Source Rename	<p>Renames the current input source to your desired name.</p> <p>On the Source Rename page, use ▲/▼/◀/▶, and OK to set the desired characters for the connected source item.</p> <p>When done, press  BACK to save the changes and exit.</p>
Auto Source	Allows the projector to automatically search for a signal.
Sound	<ul style="list-style-type: none"> • Sound Mode <ul style="list-style-type: none"> • Effect Mode: A variety of sound modes for you to choose from. • User EQ: When Effect Mode is set to User, you can further customize the mode. • Mute: Temporarily turns off the sound. • Volume: Adjusts the sound level. • Power On/Off Ring Tone: Turns on or off the ring tone when the projector is in startup and shutdown process. <p> The only way to change Power On/Off Ring Tone is setting On or Off here. Setting the sound mute or changing the sound level will not affect the Power On/Off Ring Tone.</p> <ul style="list-style-type: none"> • Reset Audio Settings: Returns all of the adjustments you've made in the Sound menu to the factory preset values. • Speaker: Turns on or off the projector's speaker(s). • Audio Return(HDMI-2): Allows the projector's audio playback (through HDMI 2) on other devices. • SPDIF: Enables or disables the SPDIF audio output port.
Eye Protection	Automatically blanks the screen when an object is within 30 cm in front of the projection lens.

SYSTEM SETUP: ADVANCED menu

Light Source Settings	<ul style="list-style-type: none"> • Light Source Timer: See Getting to know the light source hour on page 42.
------------------------------	--

<p>HDMI Settings</p>	<ul style="list-style-type: none"> • HDMI Format: Selects a suitable RGB color range to correct the color accuracy. <ul style="list-style-type: none"> • Auto: Automatically selects a suitable color range for the incoming HDMI signal. • RGB Limited: Utilizes the Limited range RGB 16-235. • RGB Full: Utilizes the Full range RGB 0-255. • YUV: Utilizes the YUV color range. • HDMI Equalizer: Adjusts the equalizer gain settings for an HDMI signal. The higher the setting, the stronger the gain value. If there are more than one HDMI port on the projector, select the HDMI port first before adjusting the value. • HDMI EDID: Allows you to adjust EDID settings for each HDMI input. • Electronic Control: To enable or disable the HDMI Electronics Control function. • Power On Link/Power Off Link <p>When you connect an HDMI CEC-compatible device to your projector with an HDMI cable, you can set the behavior of powering on/off between the device and the projector.</p> <table border="1" data-bbox="379 913 1453 1077"> <tr> <td data-bbox="379 913 694 994">From Projector</td> <td data-bbox="694 913 1453 994">When the projector is turned on/off, the connected device will be activated/shut down, too.</td> </tr> <tr> <td data-bbox="379 994 694 1077">From Device</td> <td data-bbox="694 994 1453 1077">When the connected device is turned on/off, the projector will be activated/shut down, too.</td> </tr> </table>	From Projector	When the projector is turned on/off, the connected device will be activated/shut down, too.	From Device	When the connected device is turned on/off, the projector will be activated/shut down, too.
From Projector	When the projector is turned on/off, the connected device will be activated/shut down, too.				
From Device	When the connected device is turned on/off, the projector will be activated/shut down, too.				
<p>Password</p>	<p>See Utilizing the password function on page 22.</p>				
<p>Key Lock</p>	<p>With the control keys on the projector and remote control locked, you can prevent your projector settings from being changed accidentally (by children, for example). When the Key Lock is on, no control keys on the projector will operate except  POWER.</p> <p>To release panel key lock, press and hold  (the right key) on the projector or remote control for 3 seconds.</p>  <p>If you turn off the projector without disabling panel key lock, the projector will still be in locked status the next time it is turned on.</p>				
<p>LED Indicator</p>	<p>You can turn off the LED warning lights. This is to avoid any light disturbance when viewing images in a dark room.</p>				
<p>Reset All Settings</p>	<p>Returns all settings to the factory preset values.</p>  <p>The following settings will still remain: Picture Mode, User Mode Management, Brightness, Contrast, Color, Tint, Sharpness, Advanced, Projector Position, Source Rename, and Password.</p>				

INFORMATION menu

<p>Current System Status</p>	<ul style="list-style-type: none">• Source: Shows the current signal source.• Picture Mode: Shows the selected mode in the PICTURE menu.• Dynamic Range: Shows current dynamic range.• Resolution: Shows the native resolution of the input signal.• Color System: Shows the input system format.• Light Usage Time: Shows the number of hours the light source has been used.• 3D Format: Displays the current 3D mode. <p></p> <p>3D Format is only available when 3D is enabled.</p> <ul style="list-style-type: none">• Firmware Version: Shows the firmware version of your projector.• Service Code: Shows the projector's serial number.
-------------------------------------	---

Maintenance

Care of the projector

Cleaning the lens

Clean the lens whenever you notice dirt or dust on the surface. Please be sure to turn off the projector and let it cool down completely before cleaning the lens.

- Use a canister of compressed air to remove dust.
- If there is dirt or smears, use lens-cleaning paper or moisten a soft cloth with lens cleaner and gently wipe the lens surface.
- Never use any type of abrasive pad, alkaline/acid cleaner, scouring powder, or volatile solvent, such as alcohol, benzene, thinner or insecticide. Using such materials or maintaining prolonged contact with rubber or vinyl materials may result in damage to the projector surface and cabinet material.

Cleaning the projector case

Before you clean the case, turn the projector off using the proper shutdown procedure as described in [Shutting down the projector on page 27](#) and unplug the power cord.

- To remove dirt or dust, wipe the case with a soft, lint-free cloth.
- To remove stubborn dirt or stains, moisten a soft cloth with water and a neutral pH detergent. Then wipe the case.



Never use wax, alcohol, benzene, thinner or other chemical detergents. These can damage the case.

Storing the projector

If you need to store the projector for an extended time, please follow the instructions below:

- Make sure the temperature and humidity of the storage area are within the recommended range for the projector. Please refer to [Specifications on page 45](#) or consult your dealer about the range.
- Retract the adjuster feet.
- Remove the battery from the remote control.
- Pack the projector in its original packing or equivalent.

Transporting the projector

It is recommended that you ship the projector with its original packing or equivalent.

Light source information

Getting to know the light source hour

When the projector is in operation, the duration (in hours) of light source usage is automatically calculated by the built-in timer. The method of calculating the equivalent light source hour is as follows:

Light Source Usage Time = (hours used in **Normal** mode) + (hours used in **Economic** mode) + (hours used in **SmartEco** mode)

Total (equivalent) light source hour = 1.0 x (hours used in **Normal** mode) + 1.0 x (hours used in **Economic** mode) + 1.0 x (hours used in **SmartEco** mode)



For time used in each light source mode shown in OSD menu:

- Time used is accumulated and rounded down to an integer in **hours**.
- When time used is less than 1 hour, it shows 0 hours.



When you calculate Equivalent Light source hour manually, it will probably have deviation from the value shown in OSD menu since projector system calculates time used for each light source mode in “Minutes” then rounds down to an integer in hours shown in OSD.

To obtain the light source hour information:

Go to **SYSTEM SETUP: ADVANCED > Light Source Settings > Light Source Timer** and press **OK**. The **Light Usage Time** information is displayed.

You can also get the light source hour information on the **INFORMATION > Light Usage Time** menu.

Extending light source life

- Setting the **Light Mode**

Go to **PICTURE > Advanced > Light Mode** and press **OK**. Select a suitable light source power from among the provided modes.

Setting the projector in **Economic** or **SmartEco** mode extends light source life.







































Light Mode	Description
Normal	Provides full light source brightness
Economic	Lowers brightness to extend the light source life and decreases the fan noise
SmartEco	Adjusts the light source power automatically depending on the content brightness level

- Setting **Auto Off**

This function allows the projector to turn off automatically if no input signal is detected after a set period of time to prevent unnecessary waste of light source life.

To set **Auto Off**, go to **SYSTEM SETUP: BASIC > Auto Off** and press **◀/▶**.

Indicator

Light	Status & Description
 POWER indicator (lights up constantly or flashes repeatedly)	
Power events	
	Stand-by mode
 0.5s >  0.5s >  0.5s >  0.5s <=>	Powering up
	Normal operation
 0.5s >  0.5s >  0.5s >  0.5s <=>	Normal power-down cooling
	Lens cover failed
 0.5s >  0.5s >  0.5s >  0.5s <=>	Download TI
	Burn-in ON
 0.5s >  0.5s >  0.5s >  0.5s <=>	Burn-in OFF
 0.5s >  0.5s >  1s <=>	CW failed
 0.5s >  0.5s >  1s <=>	PW failed
Light source events	
 0.5s >  0.5s >  1s <=>	Light source error in normal operation
 0.5s >  0.5s >  1s <=>	Light source is not lit up
Thermal events	
 0.5s >  0.5s >  1s <=>	Temperature I error (over limited temperature)
 0.5s >  0.5s >  1s <=>	Fan 1~ fan 6 error (the actual fan speed is outside the desired speed)

	 : Off	 : Blue	 : White	 : Red	 : Green
---	---	--	---	--	---

Troubleshooting

? The projector does not turn on.

Cause	Remedy
There is no power from the power cord.	Plug the power cord into the AC power jack on the projector, and plug the power cord into the power outlet. If the power outlet has a switch, make sure that it is switched on.
Attempting to turn the projector on again during the cooling process.	Wait until the cooling down process has completed.

? No picture

Cause	Remedy
The video source is not turned on or connected correctly.	Turn the video source on and check that the signal cable is connected correctly.
The projector is not correctly connected to the input signal device.	Check the connection.
The input signal has not been correctly selected.	Select the correct input signal with the SOURCE key.
The lens cover is still closed.	Open the lens cover.

? Blurred image

Cause	Remedy
The projection lens is not correctly focused.	Adjust the focus settings.
The projector and the screen are not aligned properly.	Adjust the projection angle and direction as well as the height of the projector if necessary.
The lens cover is still closed.	Open the lens cover.

? Remote control does not work.

Cause	Remedy
The batteries are out of power.	Replace both of the batteries with new ones.
There is an obstacle between the remote control and the projector.	Remove the obstacle.
You are too far away from the projector.	Stand within 8 meters (26 feet) of the projector.

Specifications

Projector specifications



All specifications are subject to change without notice.

Optical

Resolution
4K UHD 3840 x 2160

Display system
1-CHIP DMD

Lens
F = 2.0 mm

Clear focus range
70"–120"

Light source
Laser

Electrical

Power supply
AC100–240V, 5.1 A, 50–60 Hz (Automatic)

Power consumption
480 W (Max); < 0.5 W (Standby)

Mechanical

Weight
10 Kg ± 100 g (22.05 ± 0.22 lbs)

Output terminals

Speaker
5 watt x 2

Audio signal output
S/PDIF x 1

Control

USB
Type-A x 3 (1A/1.5A/2.5A power supply)

RS-232 serial control
9 pin x 1

IR receiver x 1

Input terminals

Video signal input
Digital
HDMI (2.0, HDCP 2.2) x 2

Environmental Requirements

Operating temperature
0°C–40°C at sea level

Storage temperature
-20°C–60°C at sea level

Operating/Storage relative humidity
10%–90% (without condensation)

Operating altitude
0–1499 m at 0°C–35°C
1500–3000 m at 0°C–30°C (with
High Altitude Mode on)

Storage altitude
30°C @ 0–12,200 m above sea level

Repairing

Please visit below website and choose your country to find your service contact window.
<http://www.benq.com/welcome>

Transporting

Original packing or equivalent is recommended.

Dimensions

500 (W) x 388 (D) x 157 (H) (including foot & slide door)

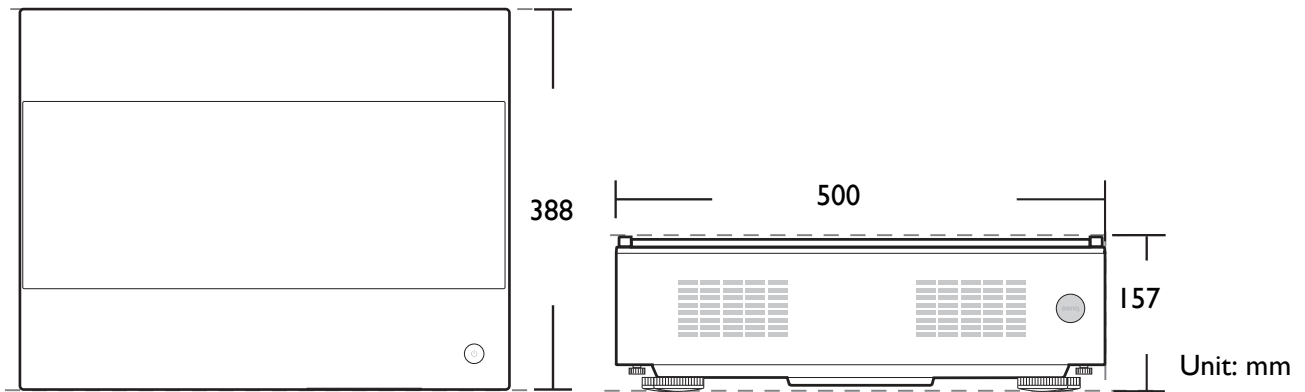

Timing chart

Supported timing for HDMI (HDCP) input

- PC timings

Resolution	Mode	Refresh rate (Hz)	H-frequency (kHz)	Clock (MHz)	3D Field Sequential	3D over-under	3D side-by-side
640 x 480	VGA_60	59.940	31.469	25.175		Supported	Supported
	VGA_72	72.809	37.861	31.500			
	VGA_75	75.000	37.500	31.500			
	VGA_85	85.008	43.269	36.000			
720 x 400	720 x 400_70	70.087	31.469	28.3221			
800 x 600	SVGA_60	60.317	37.879	40.000		Supported	Supported
	SVGA_72	72.188	48.077	50.000			
	SVGA_75	75.000	46.875	49.500			
	SVGA_85	85.061	53.674	56.250			
	SVGA_120 (Reduce Blanking)	119.854	77.425	83.000			
1024 x 768	XGA_60	60.004	48.363	65.000		Supported	Supported
	XGA_70	70.069	56.476	75.000			
	XGA_75	75.029	60.023	78.750			
	XGA_85	84.997	68.667	94.500			
	XGA_120 (Reduce Blanking)	119.989	97.551	115.500			
1152 x 864	1152 x 864_75	75.00	67.500	108.000			
1024 x 576	BenQ Notebook Timing	60.00	35.820	46.996			
1024 x 600	BenQ Notebook Timing	64.995	41.467	51.419			
1280 x 720	1280 x 720_60	60	45.000	74.250		Supported	Supported
1280 x 768	1280 x 768_60	59.870	47.776	79.5		Supported	Supported
1280 x 800	WXGA_60	59.810	49.702	83.500		Supported	Supported
	WXGA_75	74.934	62.795	106.500			
	WXGA_85	84.880	71.554	122.500			
	WXGA_120 (Reduce Blanking)	119.909	101.563	146.25			
1280 x 1024	SXGA_60	60.020	63.981	108.000		Supported	Supported
	SXGA_75	75.025	79.976	135.000			
1280 x 960	1280 x 960_60	60.000	60.000	108		Supported	Supported
	1280 x 960_85	85.002	85.938	148.500			
1360 x 768	1360 x 768_60	60.015	47.712	85.500		Supported	Supported
1440 x 900	WXGA+_60	59.887	55.935	106.500		Supported	Supported
1400 x 1050	SXGA+_60	59.978	65.317	121.750		Supported	Supported
1680 x 1050	1680 x 1050_60	59.954	65.290	146.250		Supported	Supported
640 x 480@67Hz	MAC13	66.667	35.000	30.240			
832 x 624@75Hz	MAC16	74.546	49.722	57.280			
1024 x 768@75Hz	MAC19	75.020	60.241	80.000			
1152 x 870@75Hz	MAC21	75.06	68.68	100.00			
1920 x 1080@60Hz	1920 x 1080_60	60	67.5	148.5		Supported	Supported
1920 x 1200@60Hz	1920 x 1200_60 (Reduce Blanking)	59.95	74.038	154		Supported	Supported
1920 x 1080@60Hz	1920 x 1080_60	59.963	67.158	173			
1920 x 1080@120Hz	1920 x 1080_120 (Only HDMI 2.0 supports)	120.000	135.000	297			
3840 x 2160	3840 x 2160_30	30	67.5	297			
3840 x 2160	3840 x 2160_60 (Only HDMI 2.0 supports)	60	135	594			



The timings showing above may not be supported due to EDID file and VGA graphics card limitations. It is possible that some timings cannot be chosen.

• Video timings

Timing	Resolution	Horizontal frequency (KHz)	Vertical frequency (Hz)	Dot Clock Frequency (MHz)	3D frame packing	3D over-under	3D side-by-side
480i	720 (1440) x 480	15.73	59.94	27			
480p	720 x 480	31.47	59.94	27			
576i	720 (1440) x 576	15.63	50	27			
576p	720 x 576	31.25	50	27			
720/50p	1280 x 720	37.5	50	74.25	Supported	Supported	Supported
720/60p	1280 x 720	45.00	60	74.25	Supported	Supported	Supported
1080/24P	1920 x 1080	27	24	74.25	Supported	Supported	Supported
1080/25P	1920 x 1080	28.13	25	74.25			
1080/30P	1920 x 1080	33.75	30	74.25			
1080/50i	1920 x 1080	28.13	50	74.25			Supported
1080/60i	1920 x 1080	33.75	60	74.25			Supported
1080/50P	1920 x 1080	56.25	50	148.5		Supported	Supported
1080/60P	1920 x 1080	67.5	60	148.5		Supported	Supported
2160/24P	3840 x 2160 (Only HDMI 2.0 supports)	54	24	297			
2160/25P	3840 x 2160 (Only HDMI 2.0 supports)	56.25	25	297			
2160/30P	3840 x 2160 (Only HDMI 2.0 supports)	67.5	30	297			
2160/50P	3840 x 2160 (Only HDMI 2.0 supports)	112.5	50	594			
2160/60P	3840 x 2160 (Only HDMI 2.0 supports)	135	60	594			