



205 Westwood Ave, Long Branch, NJ 07740  
Phone: 866-94 BOARDS (26273) / (732)-222-1511  
Fax: (732)-222-7088 | E-mail: [sales@touchboards.com](mailto:sales@touchboards.com)

WDP02  
Wireless FHD Kit  
User Manual



# Copyright

Copyright © 2015 by BenQ Corporation. All rights reserved. No part of this publication may be reproduced, transmitted, transcribed, stored in a retrieval system or translated into any language or computer language, in any form or by any means, electronic, mechanical, magnetic, optical, chemical, manual or otherwise, without the prior written permission of BenQ Corporation.

# Disclaimer

BenQ Corporation makes no representations or warranties, either expressed or implied, with respect to the contents hereof and specifically disclaims any warranties, merchantability or fitness for any particular purpose. Further, BenQ Corporation reserves the right to revise this publication and to make changes from time to time in the contents hereof without obligation of BenQ Corporation to notify any person of such revision or changes.

This user manual aims to provide the most updated and accurate information to customers, and thus all contents may be modified from time to time without prior notice. Please visit [www.benq.com](http://www.benq.com) for the latest version of this manual.

The illustrations and the images in this guide are for your reference.

# Table of contents

Copyright .....	2
Disclaimer .....	2
Introduction .....	4
Package content .....	4
Overview .....	6
Transmitter (Tx) .....	6
Receiver (Rx) .....	7
Remote control .....	8
LED indicators of the transmitter and the receiver .....	8
Installation .....	10
Setting up the transmitter (Tx) .....	10
Setting up the receiver (Rx) .....	12
Attaching receiver (Rx) to your BenQ projector with mounting holder .....	12
Attaching Receiver (Rx) to a ceiling mount .....	13
Placing the receiver on the provided stand .....	14
Connecting the HDMI cable and power .....	14
Connecting the HDMI cable .....	14
Power supply via a USB type A jack (1.5V) .....	15
Power supply via a power adapter .....	15
Powering up all devices and making source selection .....	16
Performing IR sync .....	17
Waking up the transmitter and the receiver .....	18
Basic operations and on-screen display (OSD) .....	19
Troubleshooting .....	20
Supported resolution .....	22
Audio bit rate support .....	23
Product specification .....	24

# Introduction

This device is the second generation of BenQ Wireless Full HD Kit.

- **Uncompressed Full HD Image Quality with 3D Support**

This solution delivers uncompressed 1080p full HD video with all types of 3D content from a Blu-ray/DVD player, set-top box, game console, or even a computer to BenQ 1080P 3D video projectors wirelessly as well as 5.1 channel digital audio.

- **Support up to 4 HDMI source devices**

The transmitter comes with 4 HDMI inputs which provide more flexibility for connecting to a variety of HDMI source devices.

- **Stream up to 30m (100 feet) with no Latency, Great for Gaming**

With four built-in omni-directional antennas, this solution transmits uncompressed video content up to 30 meters (100 feet, Line of sight)\* with no latency ideal for video gaming.

- **Ultra Stable and Fluent Streaming Quality**

This solution operates at 4.9 GHz~ 5.9 GHz frequencies and features “Dynamic Frequency Selection” technology that adjusts the communication frequency automatically in case of interference from another RF system and provides stable and fluent transmission quality for your full HD content.

- **Enhanced IR Functionality**

IR Blaster Cable is included in the package so users can point their original remote control of the AV source at the receiver directly to control source devices like switching channels.



Transmission distance depends on actual environment. Stated distance is based on line-of-sight measurement. Structures constructed of steel, wood, concrete, or brick may decrease transmission distance.

## Package content

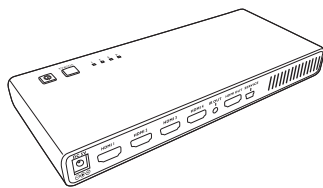

Transmitter (Tx)

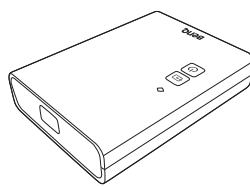

Receiver (Rx)

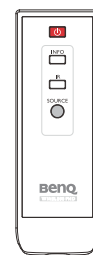

Remote Control

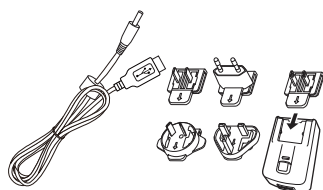

Tx\_Adapter

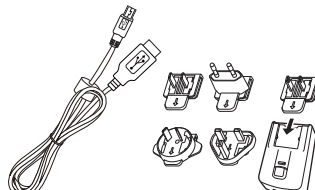

Rx\_Adapter



User Manual

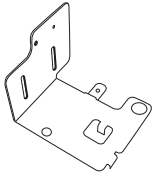

Mounting Holder

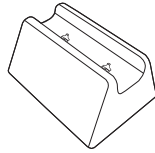

Stand

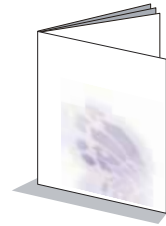

Quick Start Guide



Batteries



Screws

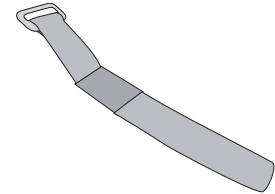

Velcro

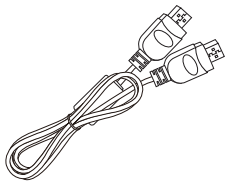

HDMI Cable

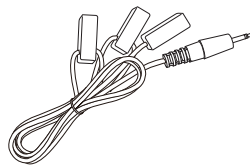

IR Blaster Cable



- Available accessories and the pictures shown here may differ from the actual contents and the product supplied for your region.
- Use original accessories to ensure compatibility.
- Always keep the product and accessories out of reach of small children.

# Overview

## Transmitter (Tx)

### Front panel buttons and indicators

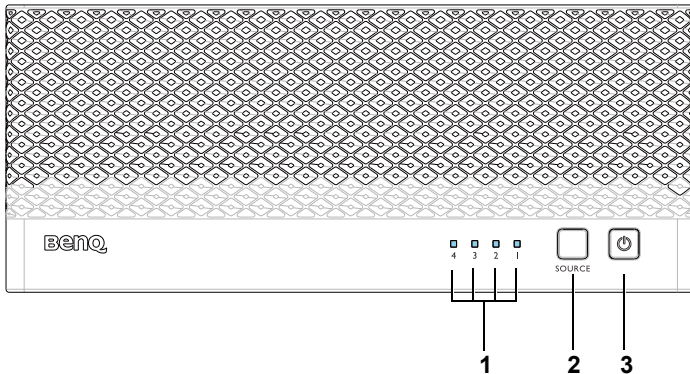

#### 1. Source indicators

These four LED indicators are lit in solid blue to show current input you switch.

#### 2. Source selection button

Press to switch source inputs of the transmitter.

#### 3. Power button with LED Indicator

Press to turn the transmitter on and off. The indicator in the power button is lit in solid blue when the power is on, and turns red in standby mode.

### Main unit back panel

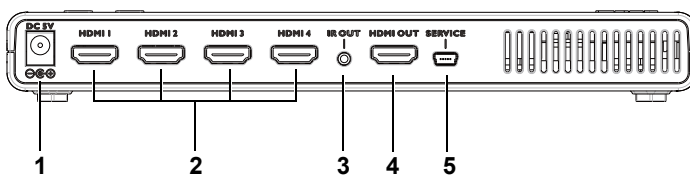

#### 1. DC in

For connecting the Tx adapter.

#### 2. HDMI 1/HDMI 2/HDMI 3/HDMI 4

Connect up to four high-definition audio/video source inputs via HDMI cables.

#### 3. IR OUT blaster extender jack

Plug the IR blaster extender cable into the IR OUT jack of the transmitter.

#### 4. HDMI OUT

Connect transmitter to second display equipped with an HDMI port via an HDMI cable.

#### 5. Service port

Service only.

# Receiver (Rx)

## Front panel buttons and indicators

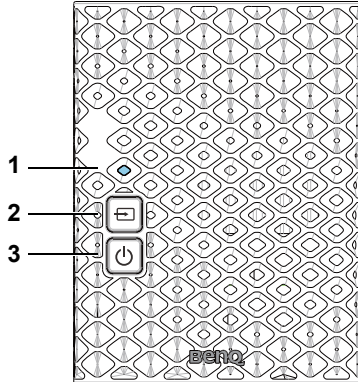

### 1. Source indicator

- The indicator lights up in solid blue when the input signal is detected.
- The indicator blinks blue if no input signal is detected.

### 2. Source button

Press this button for input source.

### 3. Power button with LED indicator

Press to turn the receiver on and off. The indicator in the power button lights up in blue when the power is on and turns red in standby mode.

## Main unit back panel

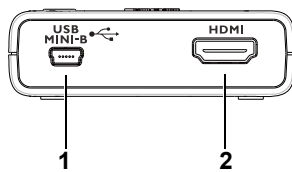

### 1. DC in

Connect to USB type A (1.5V power supply) on BenQ video projector or the receiver's power adapter.

### 2. HDMI out

Connect to BenQ video projector via the provided HDMI cable.

## Remote control

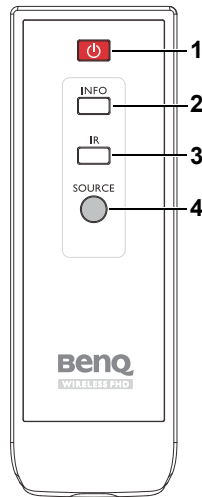

### 1. Power button

Press to turn the transmitter & receiver on/off. When both power indicators of Tx & Rx are in red, press the power button on either Tx or Rx to wake up the other automatically.

### 2. INFO button

Press this button to display OSD of system related information on the display terminal connected the receiver.

### 3. IR button

Press to switch the IR blaster frequency between 36KHz to 56KHz to meet source device's requirement. See [Performing IR sync on page 17](#) for details.

### 4. SOURCE button

Press to switch the input sources connected to the transmitter directly.

## LED indicators of the transmitter and the receiver

Please refer below for detailed indicator and OSD description of the transmitter and the receiver.

Power indicator (on Rx)	Source indicator (on Rx)	OSD Display (on Rx)	Item/Mode	Status Description
Blinking blue	Blinking	(4 levels looping)	Initial boot up/ warm up	It takes about 15~20 seconds for booting up.
Blinking blue	Blinking	/  (looping display)	Searching available channels	Continuing search available channels if system can't establish the link for over 80 seconds after initialization. (Note 1 & 4)
Static blue	Blinking (Quickly)	/	Wireless linked mode	No input from selected source. (Note 2)
Static blue	Blinking (Slowly)	/		Unrecognizable video format. (Note 3)
Static blue	Static blue			Video format is recognized.



Power indicator (on Rx)	Source indicator (on Rx)	OSD Display (on Rx)	Item/Mode	Status Description
Static red	off		Standby	Power saving



- 1.If the wireless connection is not established after over 80 seconds, the link might be lost or the transmitter is most likely out of range. You may have to verify the range and adjust or shorten the distance between the transmitter and the receiver. The maximum video transmission range for 1080p content is up to 20 m (66 feet) in line of sight (LOS), and the minimum range is 1.98 m (6.5 feet). Transmission distance varies from environments. Stated distance is based on line-of-sight measurement. Structures constructed of steel, wood, concrete, or brick may decrease transmission distance.
- 2.Please make sure the source devices have been turned on and switched the signal output to HDMI out; also try to re-plug the HDMI cable to make sure the HDMI connector had settled well.
- 3.If there is no video displayed and OSD displayed , this is an indication that the video frame rate from the computer is not supported. Please refer to [Supported resolution on page 22](#) to switch a supported video timing.
- 4.If you have more than one set of the unit, each transmitter and receiver should be at least 1.98 m (6.5 feet) away from one another.

# Installation

This section will guide you on how to prepare the unit before its initial use.

As your Wireless FHD Kit could work with different projectors, the steps required to complete the installation may vary according to actual environment and your projector specifications. Follow the procedures below and refer to the specified sections for details.

1. Connect the transmitter to the desired devices and power properly. See [Setting up the transmitter \(Tx\) on page 10](#) for details.
2. Attach the receiver to your projector and connect power. See [Setting up the receiver \(Rx\) on page 12](#) for details.

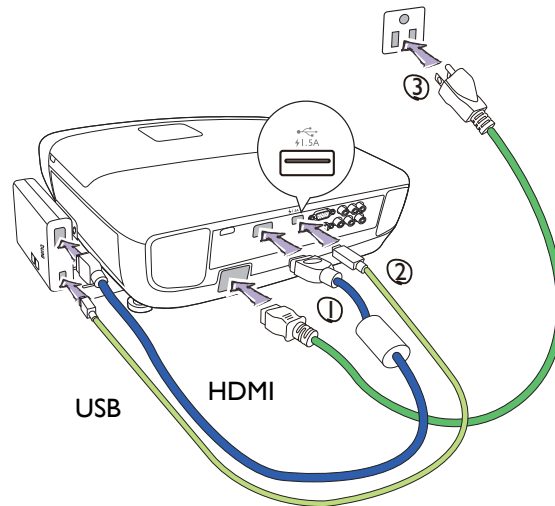

3. Make sure that all the connected devices have been powered on. Press the source button of the projector or of its remote control to select the appropriate HDMI video output, and make sure that the source has been transmitted. See [Powering up all devices and making source selection on page 16](#) for details.
4. In most cases, you should be able to control the source devices by pointing their remote control to the receiver. If the source device does not respond, perform IR sync by following instructions in [Performing IR sync on page 17](#).

## Setting up the transmitter (Tx)

Connect up to four high-definition audio/video sources to the transmitter.

1. Connect the transmitter's **HDMI 1/HDMI 2/HDMI 3/HDMI 4** jacks to the high-definition AV equipment's HDMI out jacks via HDMI cables. The transmitter is equipped with four HDMI jacks for the high-definition equipment such as Blu-ray Players or video game consoles.

2. Connect the transmitter's **HDMI OUT** to HDMI input of a second display via an HDMI cable for the loop-through connection.

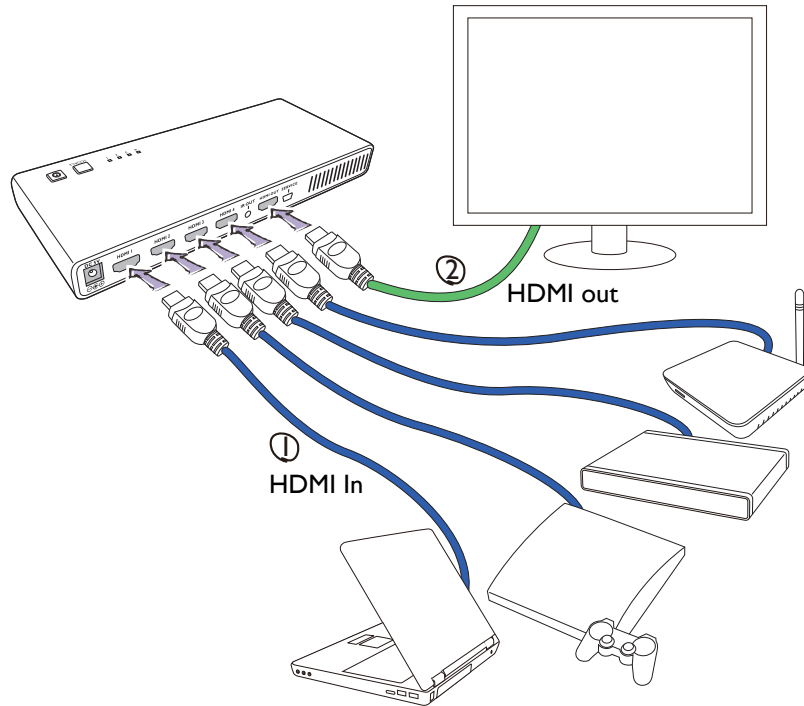

3. Connect the IR blaster cable to the IR sensor of your high-definition AV equipment. You will be able to use the remote control of the source device at the receiver side to directly operate the source device like switching channels. Plug one end of IR blaster cable into the **IR OUT** jack of the transmitter. Stick the IR blasters near the IR sensors of your high-definition audio/video devices.
4. Connect the supplied power adapter to the **DC in** jack of the transmitter and a wall socket. The indicator on the power button lights up in blue when the transmitter is connected to the power socket.

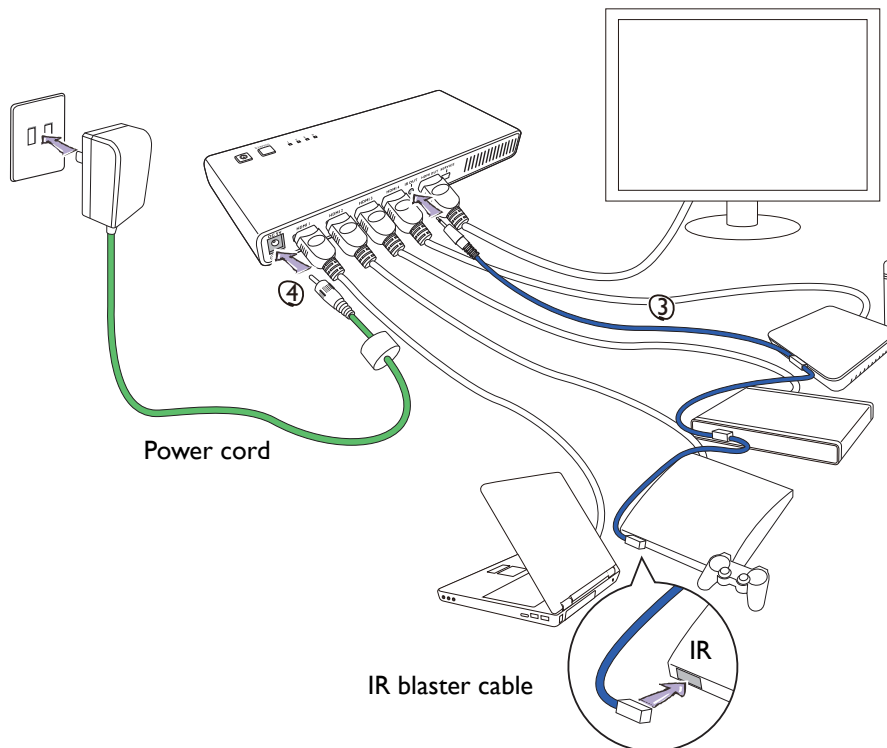

## Setting up the receiver (Rx)

You are provided with different ways to position the receiver.

- If the projector came with a screw hole at the bottom, attach the receiver to the projector using the provided mounting holder. See [Attaching receiver \(Rx\) to your BenQ projector with mounting holder on page 12](#) for more information.
- If the projector came without a screw hole at the bottom, do one of the following.
  - If the projector is mounted on the ceiling, attach the receiver to the ceiling mount using the provided Velcro strap. See [Attaching Receiver \(Rx\) to a ceiling mount on page 13](#) for more information.
  - If the projector is placed on a table, put the receiver on the provided stand right next to the projector. See [Placing the receiver on the provided stand on page 14](#) for more information.
- Certain BenQ projectors (e.g. W2000) have internal space so the receiver could be hidden side the projector directly. Refer to the projector user manual for more information.

### Attaching receiver (Rx) to your BenQ projector with mounting holder

The mounting holder helps to fix the wireless receiver to specific BenQ projectors. Depending on the purchased model, the wireless receiver may be attached to the right or left side of the projector. Refer to the illustrations and the model list for the appropriate location and the installation procedures.

Place the projector bottom up before you start the installation.

- Suitable models: W1110, HT2050, W2000, HT3050 or other models with the screw hole in the same place. Visit [www.BenQ.com](http://www.BenQ.com) for more supported models.

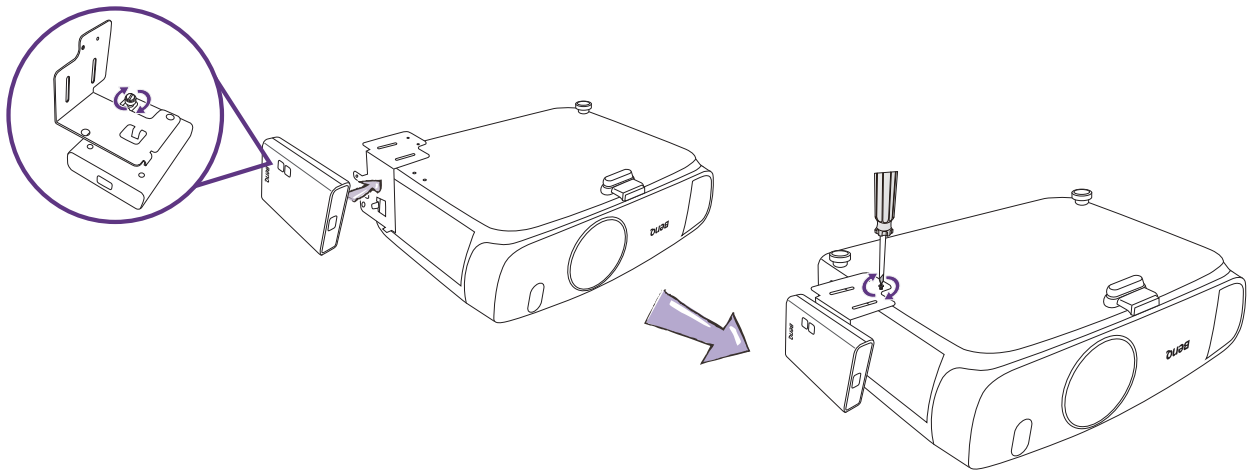

- Suitable models: WI070+, WI080ST+, HTI075, HTI085ST, WI350, W3000 or other models with the screw hole in the same place. Visit [www.BenQ.com](http://www.BenQ.com) for more supported models.

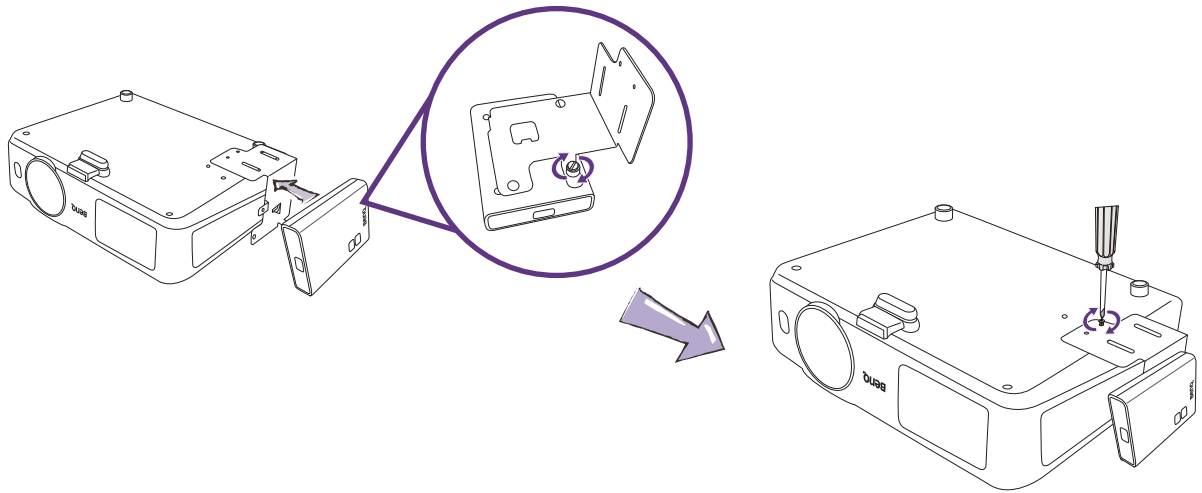

### Attaching Receiver (Rx) to a ceiling mount

If your BenQ video projector is not in the list as mentioned above, you can still use mounting holder to fix the receiver to ceiling mount when the projector is installed on the ceiling. Fix the receiver to the mounting holder first and then use supplied Velcro to fix the mounting holder and the receiver to the ceiling mount as shown in the picture.

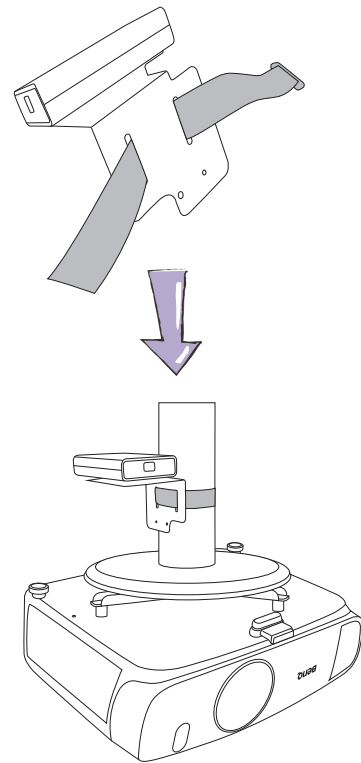

## Placing the receiver on the provided stand

If your projector is placed on a table, simply put the receiver on the provided stand as illustrated.

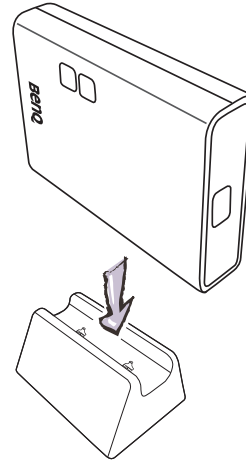

## Connecting the HDMI cable and power

Once the receiver has been positioned properly near the projector, connect the HDMI cable and power to ensure signal transmission.

To supply power to the receiver, do one of the following.

- Some of the projector models may be equipped with a USB type A jack (1.5V) to provide power supply for the receiver. See [Power supply via a USB type A jack \(1.5V\) on page 15](#) for details.
- For projector models without a USB type A jack (1.5V) for power supply, see [Power supply via a power adapter on page 15](#) for details.

## Connecting the HDMI cable

Connect the HDMI cable to the **HDMI** out jack of the receiver and the HDMI input jack of the projector.

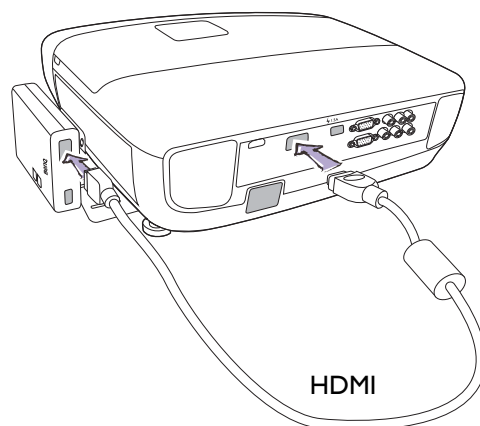

## Power supply via a USB type A jack (1.5V)

Just connect one end of supplied USB cable to the mini USB jack of the receiver and the other end to the USB type A jack (1.5V) of the projector. See the illustration.

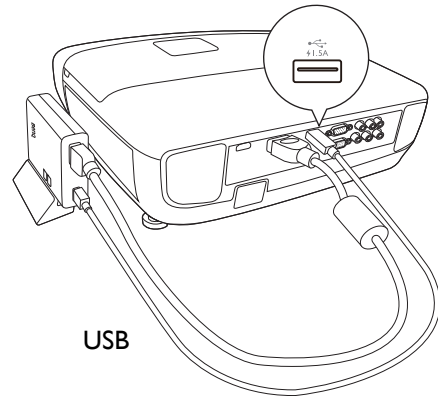

## Power supply via a power adapter

Connect the supplied USB power adapter to the mini USB jack of the receiver and a wall socket. The indicator on the power button of the receiver lights up in blue when the receiver is connected to the power mains.

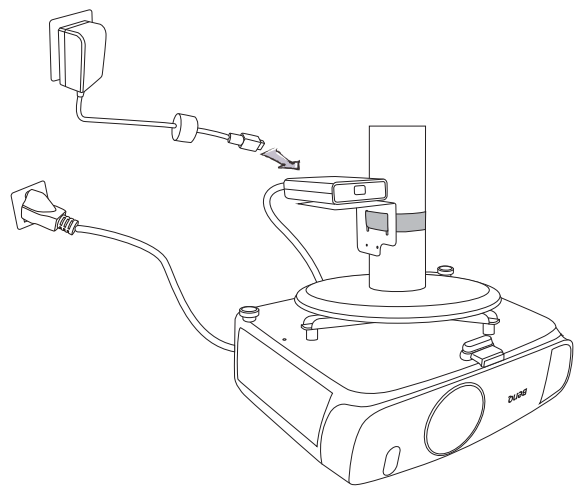

## Powering up all devices and making source selection

1. Make sure that all the connected devices are supplied with power, and turn them all on. Once being supplied with power, the transmitter and the receiver will be turned on automatically.

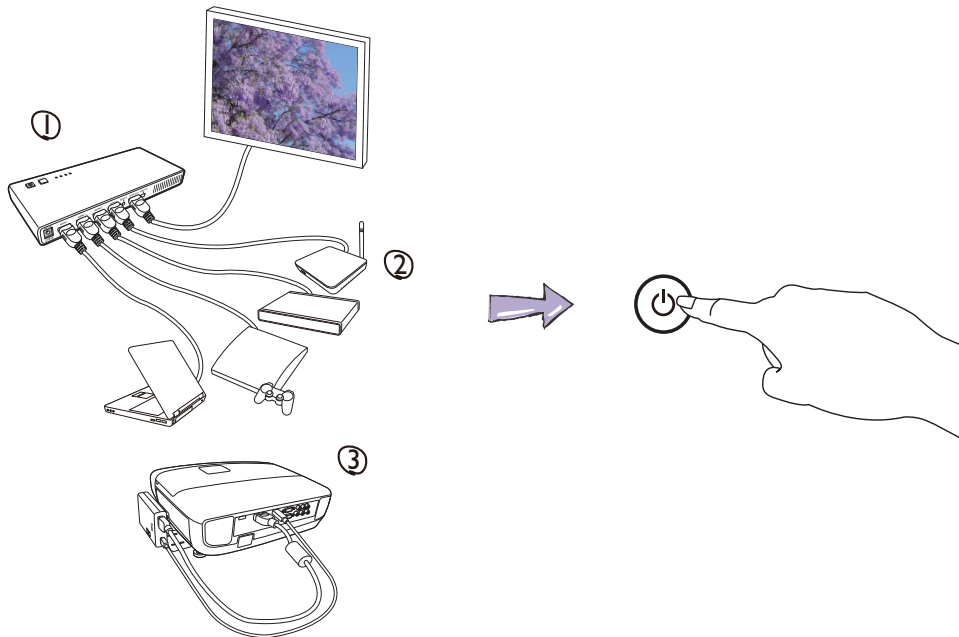

2. During the warm-up, the power indicator will blink in blue until the wireless connection between the transmitter and the receiver is established. It takes about 15 ~ 20 seconds to boot up successfully.

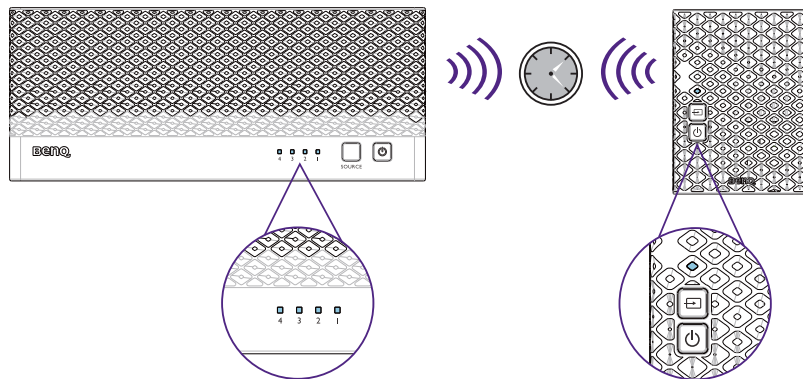

3. Ensure your projector is switched to the correct HDMI source.

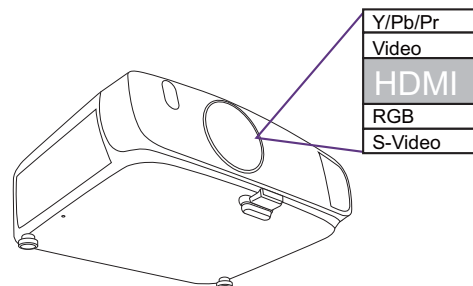



4. Press **SOURCE** button on the remote control or on the top of the receiver/the transmitter for source input switching until you see the video being transmitted.

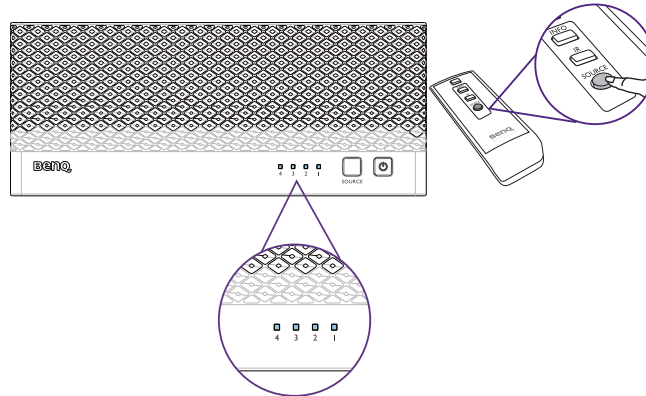

## Performing IR sync

The default IR blaster frequency setting is 47KHz, which is compatible with most remote controls. With the connected IR blaster cable, it relays infrared commands from your remote control to the connected source devices. After all the devices have been installed and powered on, you should be able to control your source devices by pointing their remote control to the receiver. If one of your source devices does not respond, follow the procedures to perform IR sync to set the IR frequency.

1. Place two AAA batteries into the remote control of the receiver/transmitter.

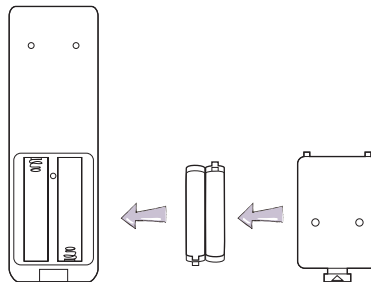

2. Make sure that the IR blaster cable has been connected with source devices and transmitter. See [Setting up the transmitter \(Tx\) on page 10](#) for details.
3. Make sure that the transmitter, receiver, and all the connected devices have been properly connected and powered on, and the desired source has been transmitted. See [Powering up all devices and making source selection on page 16](#) for details.
4. Press the **IR** button on the receiver's remote control. The current IR frequency is displayed. Press the **IR** button again to set to a different IR frequency. See [Change IR blaster frequency on page 19](#).

5. Aim the source device's remote control at the receiver and press buttons to see if the device could be controlled. If not, the IR blaster frequency needs to be set and synced again. Follow Step 4 and 5 until the source device's remote control could work.

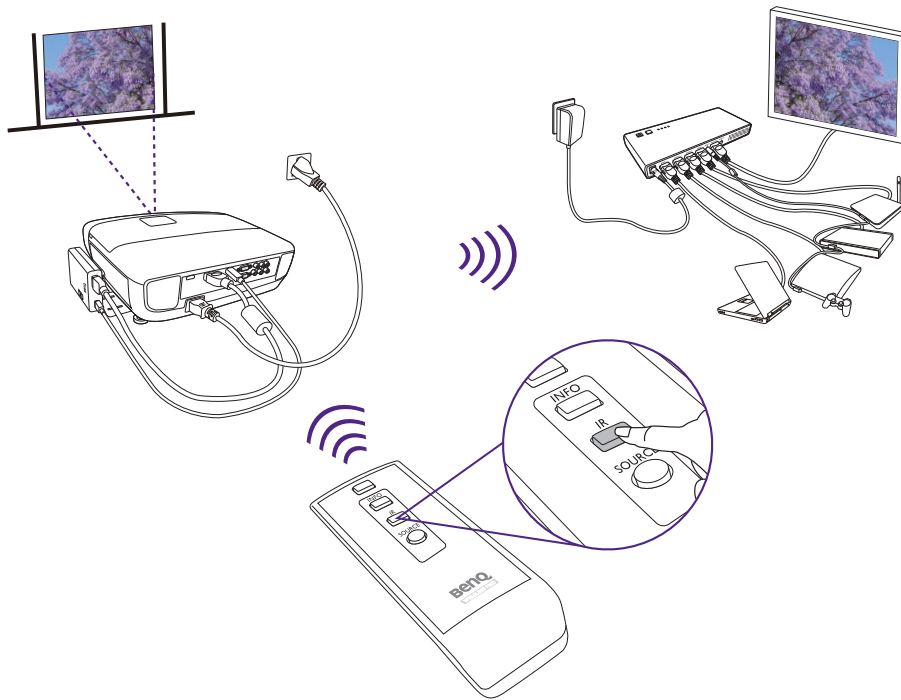

The IR sensor supports remote's signal protocol of NEC, RC5, and RC6 between 36 KHz ~ 56 KHz. Therefore, it is possible that some devices may not be supported.

## Waking up the transmitter and the receiver

- If in standby mode (both power indicators of the transmitter and the receiver are lit in red), press the power button of either the transmitter or the receiver to turn on both the transmitter and the receiver. The same condition applies to remote control operation.

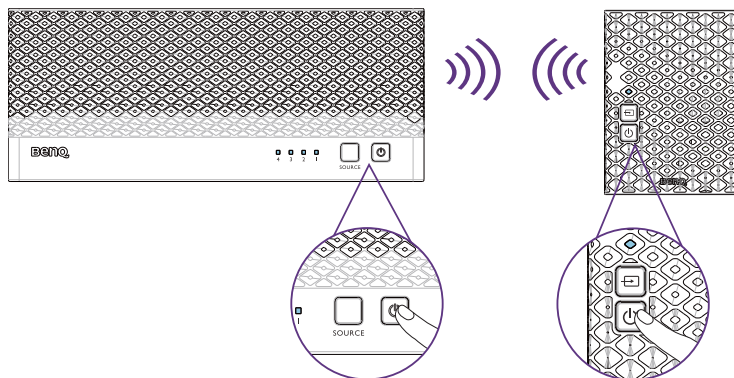







- If the transmitter's HDMI out display is on (transmitter's power indicator is lit in blue) and the receiver stays in standby mode (receiver's power indicator is lit in red), press the power button of either the receiver or the transmitter to wake up the other and make wireless connection automatically between each other.













# Basic operations and on-screen display (OSD)



Only the status of the receiver connected to the projector can be displayed on the OSD. The status of the transmitter HDMI out cannot be displayed.

Function	Operations	OSD display
Both Rx and Tx enter standby mode, while Tx's HDMI out is on	In active mode, press the power button on the top of the receiver / transmitter or on the remote control pointing to the receiver, both the transmitter and the receiver will enter standby mode while the transmitter's HDMI out is still on.	  <b>ON</b> (display for 3 seconds and then enter standby mode.)
Shows display information	Press the <b>INFO</b> button on the remote control, and information such as signal quality, source, channel, and resolution will be displayed for reference. Press the <b>INFO</b> button again to exit.	  = <b>OFF</b>
Audio / video source input selection	Press the <b>SOURCE</b> button on the remote control or on the top of the transmitter (or the receiver) for audio/video source input selection.	Example:  <b>HDMI1 CH10 1280x1024</b>
Change IR blaster frequency	Press the <b>IR</b> button of the remote control to change IR blaster frequency between 36KHz and 56KHz. The default IR blaster frequency setting is 47KHz. <ul style="list-style-type: none"> <li>• Press once for current IR frequency status display.</li> <li>• Press again to switch IR blaster frequency.</li> </ul>	Example:  <b>HDMI1 CH10 1280x1024</b> <b>ir = 38KHZ</b>

# Troubleshooting



-  The power indicator doesn't light up.
-  Check if the power plug of the receiver or the transmitter is properly inserted into a functional power outlet.
-  Poor picture quality or intermittent video.
- 
  - Check if your video resolution with HDMI input from your device is set to 1080p, 1080i, 720p, 576p, or 480p. Please refer to [Supported resolution on page 22](#) for the supported video frame rate.
  - Ensure the transmission distance is less than 100 feet in line of sight.
-  No audio.
- 
  - Check if your display's volume is properly set and not set in mute mode.
  - Check if your source player's audio volume has been turned up.
  - Ensure the bit rate of audio from the source device can be supported. Please refer to the details in [Audio bit rate support on page 23](#).
-  IR blaster can't control source device.
- 
  - Check the IR sensor location of source device. Make sure IR blaster sensor is close and straight to source device's IR sensor. Please refer to step 3 in [Setting up the transmitter \(Tx\) on page 10](#) for setup.
  - Change IR blaster frequency to meet source device's requirement. See the [Change IR blaster frequency on page 19](#) for the IR blaster frequency switching.
-  No 3D video output.
- 
  - OSD displayed: TX  or/and RX 
  - Check both display terminals (include Tx and Rx side) support 3D video format. If one of display terminals supports 2D format only, then 3D output might not supported.
  - For displaying 3D video on the supported display terminal, please turn off the 2D supported display terminal and re-power on the 3D supported display terminal. Then set the source player to 3D video format output for the 3D display.
  - Check the video output setting of source player such as Blu-ray players or video game consoles. If the video output setting of Source player is in 3D video format, It might be abnormal to display on the incompatible display terminal.



No video is displayed on the screen.



- Verify that the proper cables have been installed and selected between the transmitter input jack and your high-definition equipment jack.
- At your projector side (connected to the receiver), select HDMI as the input source.
- Verify the power indicator and **SOURCE** indicators of the receiver and the transmitter. See the following or [LED indicators of the transmitter and the receiver on page 8](#) for more information.

LED indicator	OSD display	Possible solutions
Power indicator: blinking blue	 (4 levels looping)	<ul style="list-style-type: none"> <li>• Ensure the transmission range between the transmitter and the receiver is NOT beyond 30 meters (100 feet) transmission distance in line of sight.</li> <li>• Try to move the transmitter closer to the receiver.</li> </ul>
Power indicator: solid blue Source indicator: slow flashing		<ul style="list-style-type: none"> <li>• Ensure your video resolution and frame rate is recognized and supported.</li> <li>• Connect the source device to your display to check and modify the video format compatibility.</li> <li>• Check if your video resolution with HDMI input from your device is set among 1080p, 1080i, 720p, 576p, or 480p. Please refer Chapter 5 for the detail supported Resolution.</li> </ul>
Power indicator: solid blue Source indicator: fast flashing		<ul style="list-style-type: none"> <li>• Ensure the proper cables are connected between the transmitter and your source devices.</li> <li>• Ensure your source devices connected to the transmitter are turned on.</li> <li>• Ensure the proper cables are connected between the receiver and the projector.</li> </ul>

# Supported resolution

If the **SOURCE** indicator continues to blink in blue (slower than “no signal” mode); OSD display: , and there is no video displayed or the video quality suffers, it indicates that the video frame rate from your A/V source device is not supported. Ensure that the consumer timing of your HD device is compliant with the standard listed below:

2D Video Format Timings	Resolution	Support
<b>Primary CEA Video Timing</b>		
640x480p @ 59.94 / 60Hz	480p	YES
720x480p @ 59.94Hz		YES
720x480p @ 60Hz		YES
720x576p @ 50Hz	576p	YES
1280x720p @ 50Hz	720p	YES
1280x720p @ 59.94 / 60Hz		YES
1920x1080i @ 50Hz	1080i	YES
1920x1080i @ 59.94 / 60Hz		YES
1920x1080p @ 50Hz	1080p / 60	YES
1920x1080p @ 59.94 / 60Hz		YES
<b>Secondary CEA Video Timing</b>		
1920x1080p @ 23.98 / 24Hz	1080p /24	YES
1920x1080p @ 25Hz		YES
1920x1080p @ 29.97 / 30Hz		YES
<b>VESA Timing (DVI only)</b>		
640x480 @ 59.94 / 72.809 Hz	VGA	YES
800x600 @ 60.317 / 72.188 Hz	SVGA	YES
1024x768 @ 60 / 70.069 Hz	XGA	YES
1280x768 @ 60 Hz	WXGA	YES
1280x1024 @ 60 Hz	SXGA	YES

Mandatory CEA 32D Video Format Timings	Support
1280x720p @ 50Hz Top-and-Bottom	YES
1280x720p @ 50Hz Frame packing	YES
1280x720p @ 59.94 / 60Hz Top-and-Bottom	YES
1280x720p @ 59.94 / 60Hz Frame packing	YES
1920x1080i @ 50Hz Side-by-Side (Half)	YES
1920x1080i @ 59.94 / 60Hz Side-by-Side (Half)	YES
1920x1080p @ 23.98 / 24Hz Top-and-Bottom	YES

# Audio bit rate support

- Digital Audio from HDMI inputs: Up to 6Mbit/s bit-rate support.
- Audio formats supported: AC-3 and DTS.
- 2-channel PCM: 16~24 bits audio sample with 32~96KHz sampling rate as listed below.

2channel PCM	32KHz	44.1KHz	48KHz	96KHz
16 bits	YES	YES	YES	YES
24 bits	YES	YES	YES	YES

# Product specification

General specifications			
Supported video resolutions	HDMI input	1080p, 1080i, 720p, 576p, 480p	
Supported audio formats	Digital audio	Up to 6 Mbps AC-3 and DTS	
Transmission distance	The maximum video transmission range is 30 meters (100 feet) in line of sight (LOS). The minimum range is 1.98 meters (6.5 feet).		
System Latency	No latency (<1ms)		
Antenna	High performance internal antennas		
Operating frequencies	4.9~ 5.9 GHz (including non-DFS and DFS frequency bands)		
Power supply	100~ 240V AC in, 5V 2A DC out power adapter		
Operating temperature	0~40°C		
Interfaces		Transmitter (Tx)	Receiver (Rx)
AV interfaces	HDMI input	4 (type A)	
	HDMI output	1 (type A)	1 (type A)
Control signal interface	IR sensor	Yes	Yes
	IR blaster extender	2.5 mm jack	N/A
	IR sensor extender	N/A	N/A
Power interface	Power input	5V DC jack	5V mini USB
Switches	Front power switch	Yes (one tack switch)	Yes (one tack switch)
	Front source switch	Yes (one tack switch)	Yes (one tack switch)
Indicators	Power indicator	1 x LED (two tone: blue/red)	1 x LED (two tone: blue/red)
	Source indicator	4 x blue LED	1 x blue LED
	Signal quality status	N/A	OSD displayed
Dimensions (mm)		227 (W) x 94 (L) x 26 (H)	68 (W) x 91 (L) x 20 (H)