



205 Westwood Ave, Long Branch, NJ 07740
Phone: 866-94 BOARDS (26273) / (732)-222-1511
Fax: (732)-222-7088 | E-mail: sales@touchboards.com

RP654K / RP704K
RP750K / RP860K
LCD Monitor
User Manual



Disclaimer

BenQ Corporation makes no representations or warranties, either expressed or implied, with respect to the contents of this document. BenQ Corporation reserves the right to revise this publication and to make changes from time to time in the contents thereof without obligation to notify any person of such revision or changes.

Copyright

Copyright 2017 BenQ Corporation. All rights reserved. No part of this publication may be reproduced, transmitted, transcribed, stored in a retrieval system or translated into any language or computer language, in any form or by any means, electronic, mechanical, magnetic, optical, chemical, manual or otherwise, without the prior written permission of BenQ Corporation.

Table of Contents

Safety warnings and precautions	1
Important safety instructions	2
Notes on this display	2
Notes on the LCD panel of this display	2
Safety notice for remote control	3
Battery safety notice	3
BenQ ecoFACTS	4
Package contents	5
Setting up the display	6
Mounting the display	6
Parts of the display and their functions	8
Front panel	8
Input/output terminals	9
Remote control	10
Using the remote control	12
Connection	14
Connecting the VGA input	14
Connecting the touch module	14
Connecting the digital inputs	15
Connecting the AV inputs	16
Connecting the coaxial output	17
Connecting the video output	18
Connecting to serial port	19
Connecting power	20
Basic operations	21
Turning the display on or off	21
Turning off the display by Quickoff	21
Initial setup	22
Account setting	22
Switching input signals	26
Downloading software	26
Setting up the Internet connection	26

Updating software.....	29
Adjusting audio volume level.....	30
Important instructions for using the touch screen	35
Menu operations.....	36
One touch menu operation.....	36
Settings menu.....	36
System settings	42
Android system interface	47
Main interface	47
APPS	54
BenQ Suggest	54
InstaQShare	55
InstaQPrint	56
WPS Office	57
Keeper	59
Screen Push	59
Maths Tutor	60
Email	61
Side Tool Bar	62
Zoom	63
Product information.....	64
Specifications.....	64
Dimensions (RP654K).....	67
Dimensions (RP704K).....	68
Dimensions (RP750K).....	69
Dimensions (RP860K).....	70
Supported input signal resolution	71
Troubleshooting.....	73

Safety warnings and precautions



The lightning flash with arrowhead symbol, within an equilateral triangle, is intended to alert the user to the presence of uninsulated “dangerous voltage” within the product’s enclosure that may be of sufficient magnitude to constitute a risk of electric shock to persons.



The exclamation point within an equilateral triangle is intended to alert the user to the presence of important operating and maintenance (servicing) instructions in the literature accompanying the appliance.



THIS EQUIPMENT MUST BE GROUNDED

To ensure safe operation, the three-pin plug must be inserted only into a standard three-pin power outlet which is effectively grounded through normal household wiring. Extension cords used with the equipment must have three cores and be correctly wired to provide connection to the ground. Wrongly wired extension cords are a major cause of fatalities.

The fact that the equipment operates satisfactorily does not imply that the power outlet is grounded or that the installation is completely safe. For your safety, if you are in any doubt about the effective grounding of the power outlet, please consult a qualified electrician.

- The mains plug of the power supply cord shall remain readily operable. The AC receptacle (mains socket outlet) shall be installed near the equipment and shall be easily accessible. To completely disconnect this equipment from the AC mains, disconnect the power cord plug from the AC receptacle.
- Do not place this display on an uneven, sloping or unstable surface (such as a trolley) where it may fall and cause damage to itself or others.
- Do not place this display near water, like a spa or pool, or in a position which will allow the splashing or spraying of water onto the display, like in front of an open window where rain water may enter.
- Do not install this display in a confined space without proper ventilation and air circulation, such as in a closed cabinet. Allow proper space around the display for dissipating heat inside. Do not block any openings and vents on the display. Overheating may result in hazards and electric shock.
- Installation of this display should only be performed by a qualified technician. Failure to install this display properly may cause injuries and damages to the personnels and the display itself. Check the installation regularly and maintain the display periodically to ensure the best working condition.
- Use only the accessories approved or recommended by the manufacturer to mount this display. Using wrong or unsuitable accessories may cause the display to fall and result in serious personal injuries. Make sure that the surface and fixing points are strong enough to sustain the weight of the display.
- To reduce the risk of electric shock, do not remove covers. No user serviceable parts inside. Refer servicing to qualified service personnel.
- To prevent personal injuries, mounting the display or installing desktop stands is required before use.

Important safety instructions

1. Read these instructions.
2. Keep these instructions.
3. Heed all warnings.
4. Follow all instructions.
5. Do not use this apparatus near water.
6. Clean only with dry cloth.
7. Do not block any ventilation openings. Install in accordance with the manufacturer's instructions.
8. Do not install near any heat sources such as radiators, heat registers, stoves, or other apparatus (including amplifiers) that produce heat.
9. Do not defeat the safety purpose of the polarized or grounding-type plug. A polarized plug has two blades with one wider than the other. A grounding-type plug has two blades and a third grounding prong. The wide blade or the third prong are provided for your safety. If the provided plug does not fit into your outlet, consult an electrician for replacement of the obsolete outlet.
10. Protect the power cord from being walked on or pinched particularly at plugs, convenience receptacles, and the point where they exit from the apparatus.
11. Only use attachments/accessories specified by the manufacturer.
12. Use only with the cart, stand, tripod, bracket, or table specified by the manufacturer, or sold with the apparatus. When a cart is used, use caution when moving the cart/apparatus combination to avoid injury from tip-over.
13. Unplug this apparatus during lightning storms or when unused for long periods of time.
14. Refer all servicing to qualified service personnel. Servicing is required when the apparatus has been damaged in any way, such as power-supply cord or plug is damaged, liquid has been spilled or objects have fallen into the apparatus, the apparatus has been exposed to rain or moisture, does not operate normally, or has been dropped.



Notes on this display

- This display weighs more than 100 kilograms. Do not attempt to lift the display alone.
- Make sure you have four or more people available to help lift or a flat cart to transport the display to its final location.
- Keep the display horizontal as much as possible.
- Clear a floor space before unpacking.

Notes on the LCD panel of this display

- The Liquid Crystal Display (LCD) panel of this display has a very thin protective layer of glass which is liable to marking or scratching, and cracking if struck or pressured. The liquid crystal substrate is also liable to damage under excessive force or extreme temperatures. Please handle with care.
- The response time and brightness of the LCD panel may vary with the ambient temperature.

- Avoid placing the display in direct sun or where direct sun or spot lighting will shine onto the LCD panel, as the heat may damage the panel and the external casing of the display, and the bright light will make viewing the display more difficult than necessary.
- The LCD panel consists of individual pixels to display images and is manufactured according to the design specifications. While 99.9% of these pixels work normally, 0.01% of the pixels may remain constantly lit (in red, blue or green) or unlit. This is a technical limitation of the LCD technology and is not a defect.
- LCD screens, like plasma (PDP) and conventional CRT (Cathode Ray Tube) screens, are also susceptible to 'screen burn-in' or 'image retention' which can be found on the screen as visible fixed lines and shades. To avoid such damage to the screen, avoid displaying still images (like On-Screen Display menus, TV station logos, fixed/inactive text or icons) for more than 30 minutes. Change the aspect ratio from time to time. Fill the entire screen with the image and eliminate the black bars whenever possible. Avoid displaying images in 4:3 aspect ratio over a long period of time, otherwise there may be visible burn marks on the screen as two vertical lines.
Note: Under certain circumstances, condensation may occur on the inner side of the cover glass, it's a natural phenomenon and will not affect the operation of the display. This condensation will usually disappear after around 2 hours of normal operation.
- RP series does not offer image retention function, for more information, please refer to installation guide. If a still image is required for a display, it is recommended to enable **Pixel Shift**. See [Adjust settings \(VGA-only\) on page 40](#) for more information.
- RP series does not support portrait use; portrait use may cause display damage. BenQ warranty will not cover faulty usage.

Safety notice for remote control

- Do not put the remote control in the direct heat, humidity, and avoid fire.
- Do not drop the remote control.
- Do not expose the remote control to water or moisture. Failure to do so could result in malfunction.
- Confirm there is no object between the remote control and the remote sensor of the product.
- When the remote control will not be used for an extended period, remove the batteries.

Battery safety notice

The use of the wrong type of batteries may cause chemical leaks or explosion. Please note the following:

- Always ensure that the batteries are inserted with the positive and negative terminals in the correct direction as shown in the battery compartment.
- Different types of batteries have different characteristics. Do not mix different types.
- Do not mix old and new batteries. Mixing old and new batteries will shorten battery life or cause chemical leaks from the old batteries.
- When batteries fail to function, replace them immediately.
- Chemicals which leak from batteries may cause skin irritation. If any chemical matter seeps out of the batteries, wipe it up immediately using a dry cloth, and replace the batteries as soon as possible.

- Due to varying storage conditions, the battery life for the batteries included with your product may be shortened. Replace them within 3 months or as soon as you can after initial use.
- There may be local restrictions on the disposal or recycling of batteries. Consult your local regulations or waste disposal provider.

BenQ ecoFACTS

BenQ has been dedicated to the design and development of greener product as part of its aspiration to realize the ideal of the “Bringing Enjoyment 'N Quality to Life” corporate vision with the ultimate goal to achieve a low-carbon society. Besides meeting international regulatory requirement and standards pertaining to environmental management, BenQ has spared no efforts in pushing our initiatives further to incorporate life cycle design in the aspects of material selection, manufacturing, packaging, transportation, using and disposal of the products. BenQ ecoFACTS label lists key eco-friendly design highlights of each product, hoping to ensure that consumers make informed green choices at purchase. Check out BenQ's CSR Website at <http://csr.BenQ.com/> for more details on BenQ's environmental commitments and achievements.



Package contents

Open the sales package and check the contents. If any item is missing or damaged, please contact your dealer immediately.

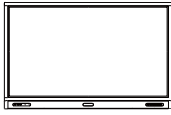

LCD display

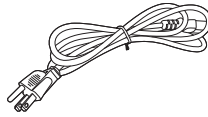

Power cord x 4

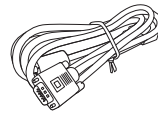

D-Sub (15-pin)
cable x 1



Audio interface
cable



Quick start guide

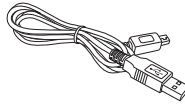

USB cable x 1

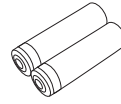

AAA battery x 2



NFC Pen x 2



Remote control



- The type of power cord supplied may differ from that illustrated depending on your region of purchase.
- Before discarding the package, check that you haven't left any accessories inside the box.
- Dispose of packaging materials wisely. You can recycle the cardboard carton. Consider storing the package (if possible) for future transport of the display.
- Do not leave plastic bags within reach of young children or babies.

Setting up the display

Mounting the display

You can install the display on a vertical surface with a suitable wall mounting bracket or on a horizontal surface with the optional desktop stands. Please pay attention to the following notes during installation:

- This display should be installed by at least two adult persons. Attempting to install this display by only one person may result in danger and injuries.
- Refer the installation to qualified technicians. Improper installation may cause the display to fall or malfunction.

Installing the display on a wall

1. Place a clean, dry and lint-free cloth on a flat, horizontal and object-free surface. Make sure that the size of the cloth is larger than the display.
2. Gently lay the display on the cloth with the LCD screen facing down.
3. Remove the desktop stands from the display if installed.

RP654K *Screw type: M8*25L

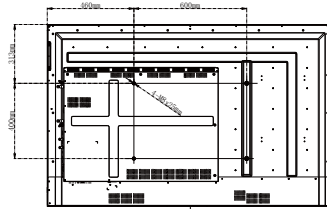

4. Identify the wall mounting screw holes on the back of the display as shown in the illustration.

RP704K *Screw type: M8*25L

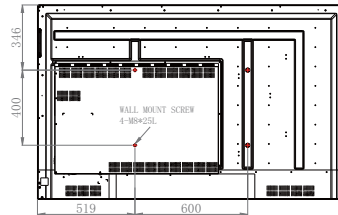

RP750K *Screw type: M8*25L



RP860K *Screw type: M8*25L



5. Install the wall mounting bracket on the display and attach the display to the wall according to the mounting bracket's instructions. The length of the screw should exceed the thickness of the wall mounting bracket by at least 25 mm. Make sure that all screws are tightened and secured properly. (Recommended torque: 470 - 635N•cm). The mounting means should be strong enough to bear the weight of the display.

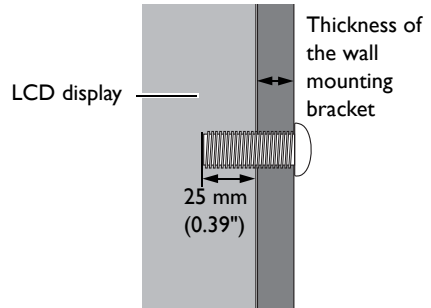

- To maintain proper ventilation, keep at least 10 mm of clear space from the back cover of the display to the wall.
- Please consult a professional technician for wall mount installations. The manufacturer accepts no liability for installations not performed by a professional technician.

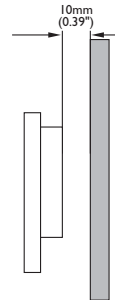

Parts of the display and their functions

Front panel

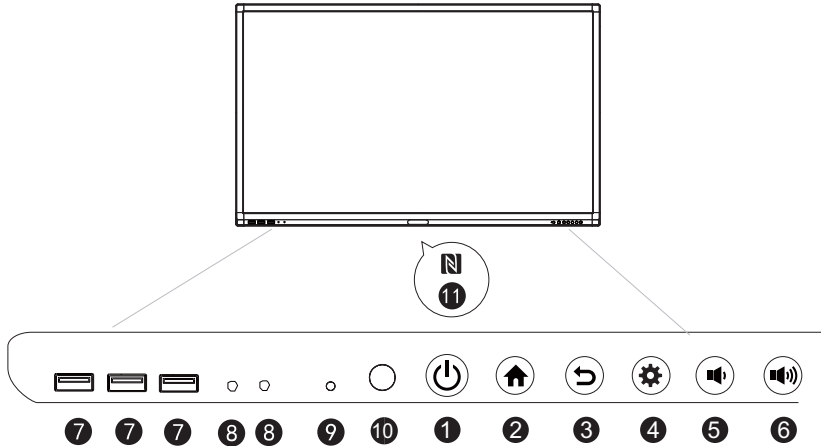

No.	Name	Description
1	Power	Tap to enter energy saving mode. Press and hold for 2 seconds or more to power off.
2	Home	Press to back to main screen.
3	Return	Press to return to previous level of menu.
4	Menu	Press to enter function menu.
5	Volume Down	Press to decrease volume.
6	Volume Up	Press to increase volume.
7	Media USB	IFP USB interface.
8	Mic	To receive sound.
9	Light Sensor	To detect if a source of light moves toward the sensor's range.
10	Remote Control Signal Receiver	Receive remote control signals. Do not obstruct the receiver.
11	NFC Function	NFC Sensor: NFC reader & writer.

Input/output terminals

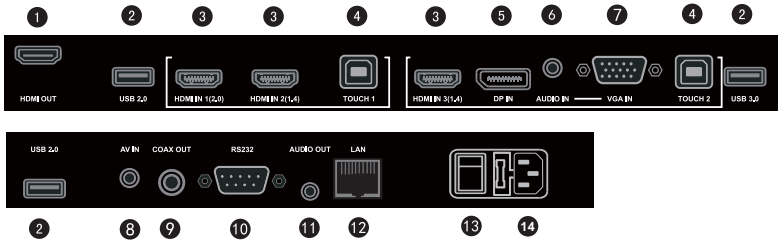

No.	Name	Description
①	HDMI OUT	Connect to the display devices with an HDMI input.
②	USB 2.0 / USB 3.0	Connect USB devices such as USB keyboards, USB mice, and USB flash drives.
③	HDMI IN	High-definition multimedia interface signal input. Connect to PC with an HDMI output, a set-top-box, or other video devices capable of realizing touch function.
④	TOUCH	External computer touch signal input. When connecting external computer, besides connecting external computer VGA and audio signals, external computer's USB port needs to be connected to the equipment. Under the condition that driver is installed, external computer can be touch controlled through the equipment (touch function is effective in VGA and HDMI channel by default)
⑤	DP IN	Connect a video source to a display device.
⑥	AUDIO IN	External computer audio input.
⑦	VGA IN	Receive analog RGB signals from an external device (such as a computer).
⑧	AV IN	Composite video and audio input.
⑨	COAX OUT	Coaxial output.
⑩	RS232	Serial interface, used for mutual transfer of data between devices.
⑪	AUDIO OUT	Output audio signals to an external device.
⑫	LAN	LAN interface, connecting RJ45 terminals. This network port is only used for the closed Android OS on this product.
⑬	POWER SWITCH	Open and shut down AC power supply. Refer to Turning the display on or off on page 21 for more information.
⑭	AC IN	AC power input, connecting AC power supply. Refer to Connecting power on page 20 for more information.



• USB2.0= 5V \equiv 500mA / USB3.0= 5V \equiv 900mA

• \equiv : Direct Current / DC

• \sim : Alternating Current /AC

• The maximum length for the cables to be used with the USB slots are 5m (USB 2.0) and 3m (USB 3.0).

Remote control

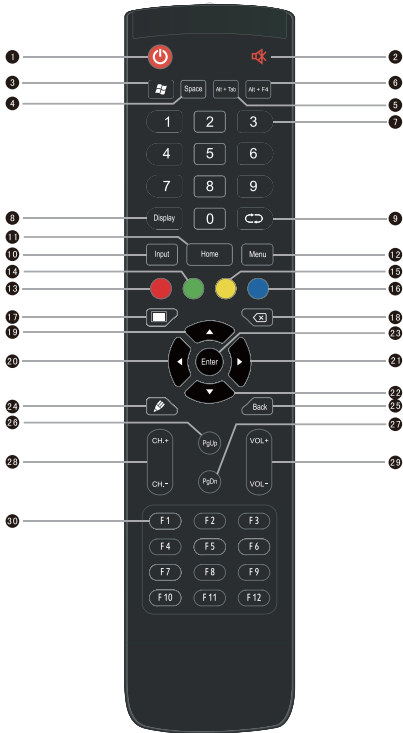

Turn the display on or off.



Turn on or off the mute function.



Built-in computer Windows key.



Built-in computer space key.



Built-in computer Alt+Tab key.



Built-in computer program window close button.



Perform as numeric buttons.



Show the current input source and information.



TV channel return key.



Select the input source. Refer to [Switching input signals on page 26](#) for more information.



Android system main screen button.



Open or close the OSD menu.



Lock the keyboard and touch function.



Lock keypad.



Lock touch.



Freeze screen.

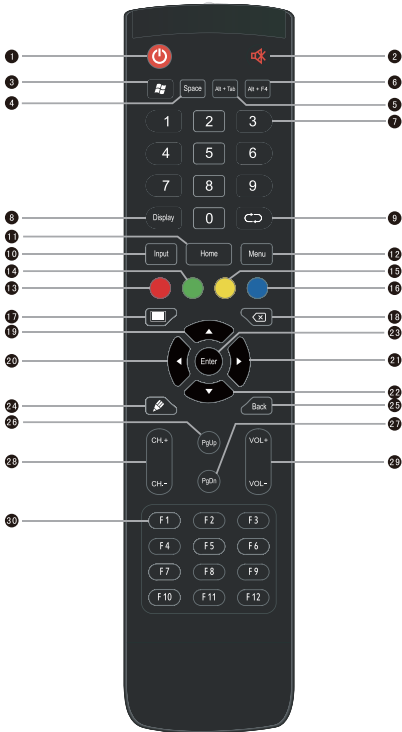

17 One key for blank screen.



18 Backspace key.



19 Direction key. Press for upward selection.



20 Direction key. Press for left selection.



21 Direction key. Press for right selection.



22 Direction key. Press for downward selection.

23 ENTER

Confirms your selection or save changes.



24 Quickly start writing application (EZWrite). Select writing pen quickly if the application is started.

25 Back

Return key.

26 PgUp

Built-in computer page (previous page).

27 PgDn

Built-in computer page (next page).

28 CH+/CH-

Channel switch key.

29 VOL+/VOL-

Volume switch key.

30 F1 - F12

Built-in computer F1 - F12 function keys.



- Built-in computer is not available. All buttons related to computer are regarded as disabled in case of no built-in computer.
- TV functions are not available.

Using the remote control

Installing remote control batteries

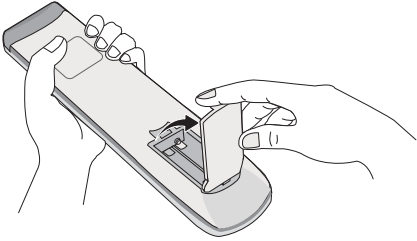

1. Open the remote control battery compartment cover.

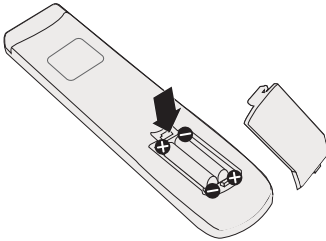

2. Insert the supplied batteries ensuring that the positive and negative marked battery terminals match the (+) and (-) marks in the battery compartment.



The supplied batteries are provided for your convenience so that you can operate the display straight away. You should replace them as soon as possible.

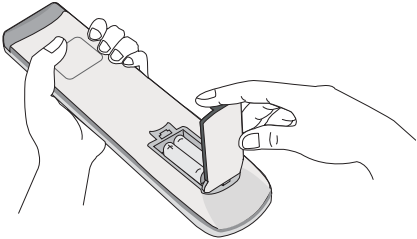

3. Refit the battery compartment cover.
-

Remote control usage tips

- Point and aim the top front of the remote control directly at the display's remote control sensor window when you press the buttons.
- Do not let the remote control become wet or place it in humid environments (like bathrooms).
- If the display's remote control sensor window is exposed to direct sunlight or strong light, the remote control may not operate properly. In this situation, change the light source, readjust the angle of the display or operate the remote control from a location closer to display's remote control sensor window.

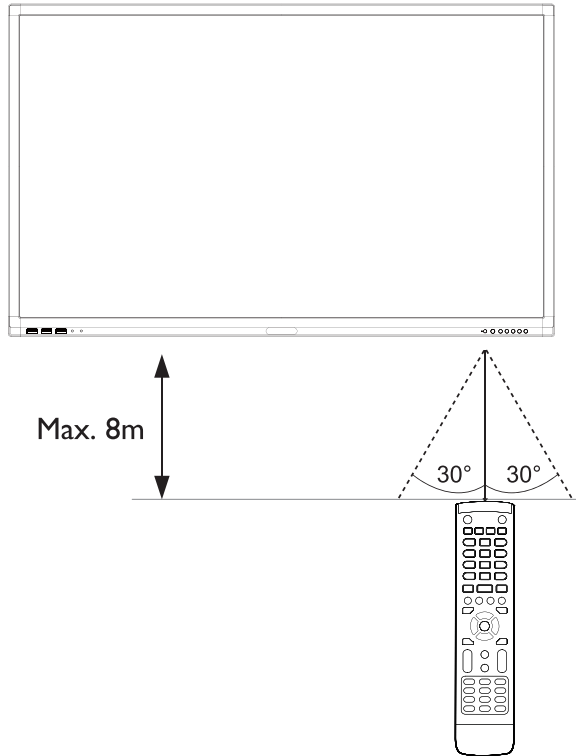

Connection

Connecting the VGA input

1. Connect the **VGA IN** jack on the display to the VGA output jack on a computer using a D-Sub (15-pin) cable.
2. Connect the computer's audio output jack to the **AUDIO IN** jack on the display with a suitable audio cable.
3. To view images from this input, press the **INPUT** button on the remote control to switch to respective input source.

Connecting the touch module

Connect the **TOUCH** (type B) jack on the display to the USB port of a computer using the supplied USB cable. The touch module of the display supports easy Plug-and-Play operation. There is no need to install additional drivers on the computer.

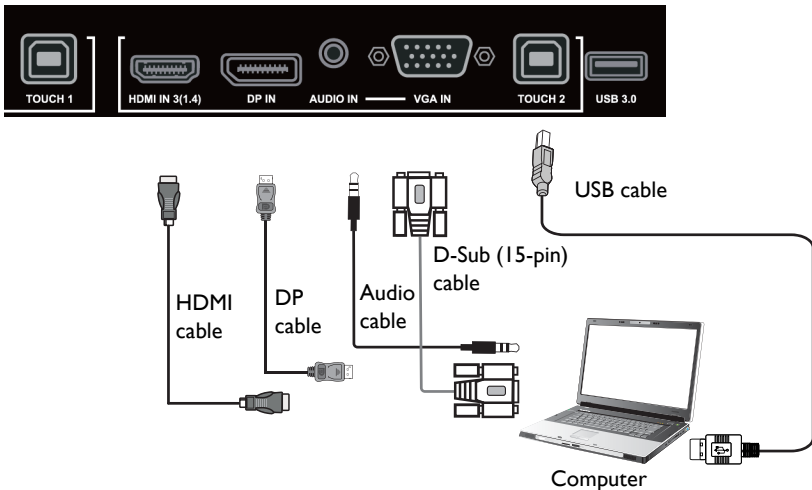

- Avoid blocking the touch screen frame (where sensors are located) when initiating the touch module.
- It is highly recommended that you connect the display to the PC or laptop directly. Avoid connecting the display to a face plate device which may cause failures in touch operations.
- If any ghost image occurs, please try to un-plug and then re-plug all USB cables. If the failure image still exists, use another USB type B to A cable.
- **TOUCH 2** port must be connected with **HDMI 3**, **DP**, or **VGA IN**.

Connecting the digital inputs

1. Connect the HDMI output jack of a computer or A/V device (such as a VCR or DVD player) to the **HDMI** input jack on the display using an HDMI cable.
2. To view images from this input, press the **INPUT** button on the remote control to switch to respective input source.

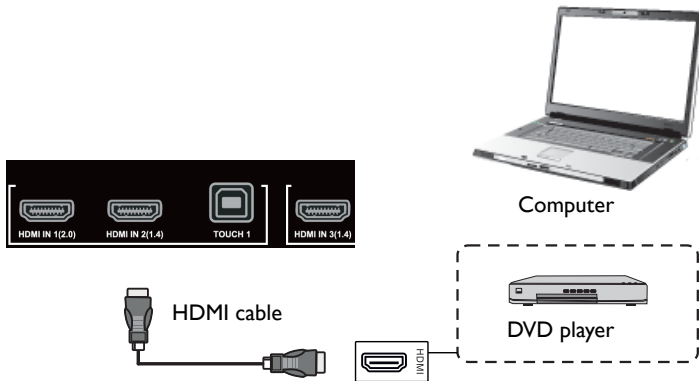

- The applicable cable is not supplied and should be purchased separately.
- The display provides a selection for the dual-monitor mode.
- **TOUCH 1** port must be connected with **HDMI 1** or **HDMI 2**.

Connecting the AV inputs

1. Connect the **AV IN** jack on the display to the output jack on an A/V device (such as a VCR) using an appropriate video cable.
2. Connect the VCR's audio output jacks to the **AV IN** jacks on the display using a suitable audio cable.
3. To view images from this input, press the **INPUT** button on the remote control to switch to respective input source.

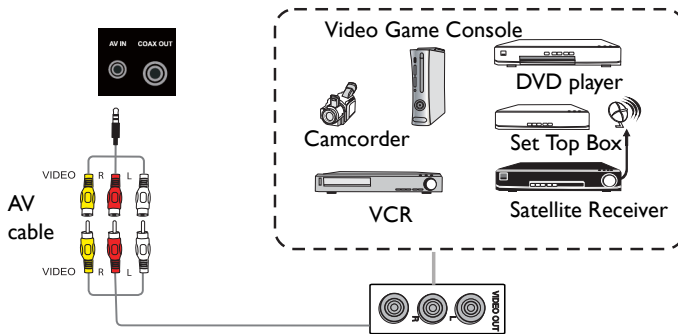

The applicable cable is not supplied and should be purchased separately.

Connecting the coaxial output

To use coaxial out for acoustic applications:

1. Use coaxial cable to connect via **COAX OUT** to your audio equipment.
2. Plug in power cord, and switch power on.

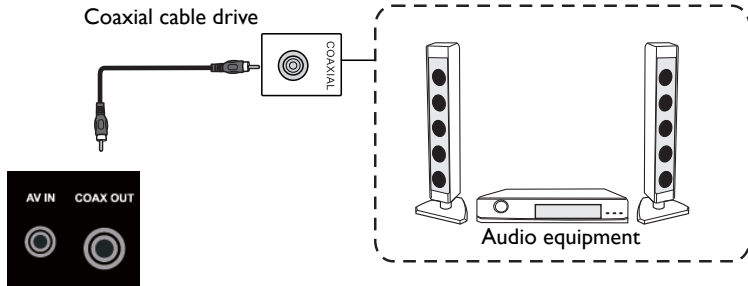

The applicable cable is not supplied and should be purchased separately.

Connecting the video output

For computer:

1. Use HDMI cable to connect from **HDMI OUT** to the respective jacks of the devices.
2. Plug in power cord, and switch power on.
3. Press  on the remote control to turn on the display.

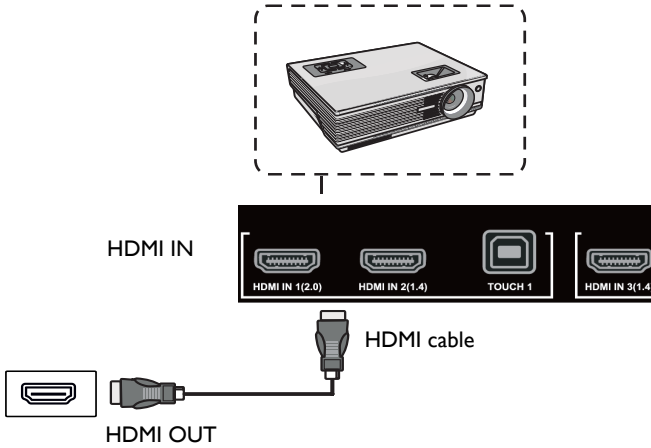

Connecting to serial port

Directly connect the computer to **RS232** ports on the input/output terminals.

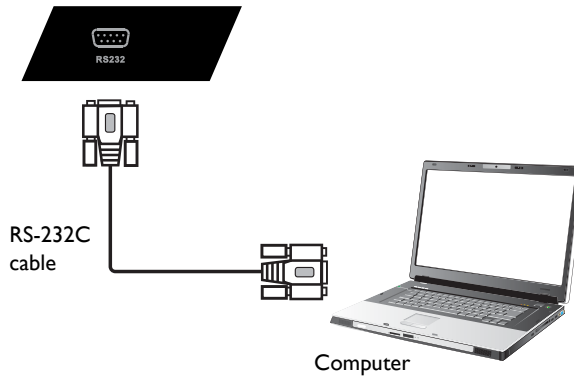

- The applicable cable is not supplied and should be purchased separately.
- This connection is applicable to straight-through RS-232C cable only.
- After using serial port line to connect central control equipment and machine, certain function of the machine can be controlled via central control equipment, such as: machine on/off, and adjustment of sound volume, etc.

Connecting power

Plug one end of the power cord into the **Power** jack on the display and the other end into an appropriate power outlet (if the outlet is switched, turn on the switch).

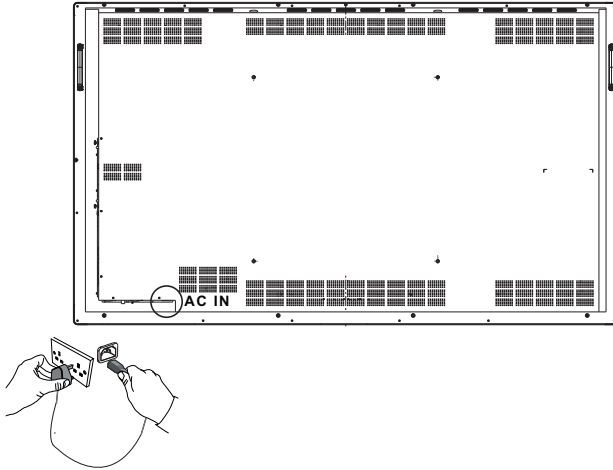

- The supplied power cord is suitable for use with 100-240V AC power only.
 - The power cord and outlet illustrated may differ from the ones used in your region.
 - Only use an appropriate power cord for your region. Never use a power cord which appears damaged or frayed, or change the plug type on the power cord.
 - Be aware of the power loading when you use extension cords or multiple outlet power boards.
 - There are no user serviceable parts in this display. Never unscrew or remove any covers. There are dangerous voltages inside the display. Turn off the power and unplug the power cord if you intend to move the display.
 - The illustration is for your reference only.
-

Basic operations

Turning the display on or off

1. Be sure to following the instruction of [Connecting power on page 20](#).
2. Before turning on the display, make sure the Power switch is set to ON. The system will enter standby mode.

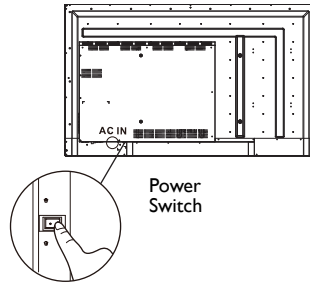

- To turn on the display, press the **Power** button on the control panel or on the remote control.
- To turn off the display, press the **Power** button on the control panel or on the remote control. The system will automatically enter standby mode.

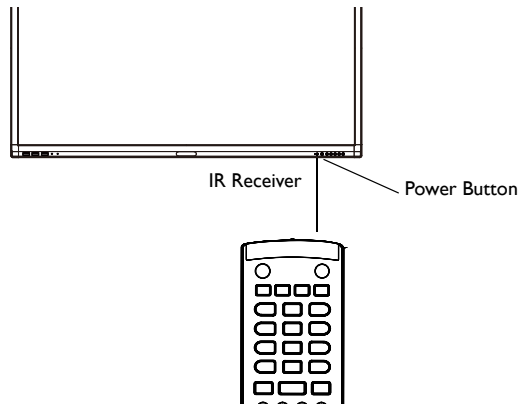

The display's standby mode still consumes power. To completely cut off power supply, set the Power switch to OFF (O) and then disconnect the power cord from the power outlet.

Turning off the display by Quickoff

Tap **Apps** (⊞) > **Quickoff** (⏻) on the screen to turn off the display without using the remote control.

Initial setup

After you have connected the display to the power, you are ready to power on the display. The first time you power on the display, you will be guided through a series of setup screens. Follow the on-screen instructions or the steps below to start up your display and complete the initial setup.

1. Turn on the display. Wait for the display to boot up with the BenQ screen. This may take a moment.
2. Tap **Next** on the screen to begin. Follow the on-screen instructions to set up the language, date and time, and network. Or you can skip some of these steps and complete the setup later.

Account setting

Tap **Account Setting** () on the screen to set account.

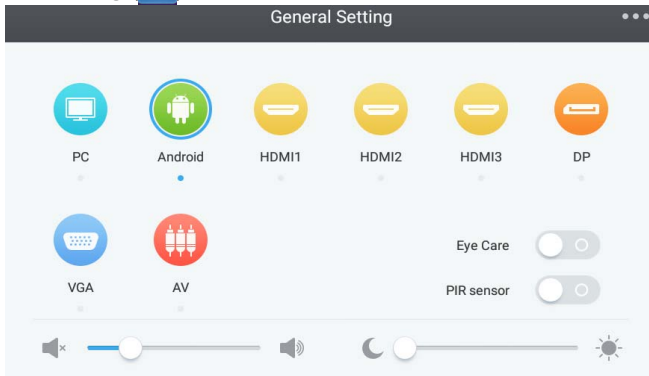

General Settings

1. Under **General Settings**, you can change wallpaper and adjust volume and backlight.

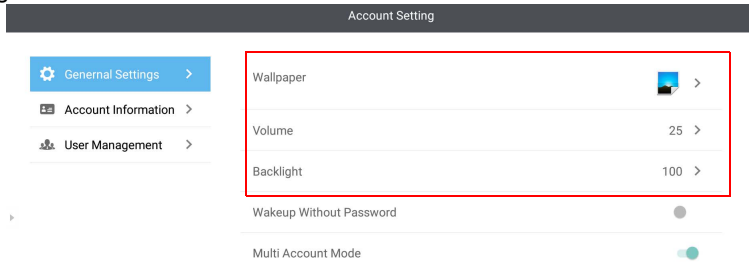

2. Log in as Admin. Set **Wakeup Without Password** to on, and next time you don't need to enter password to unlock the display on wakeup.

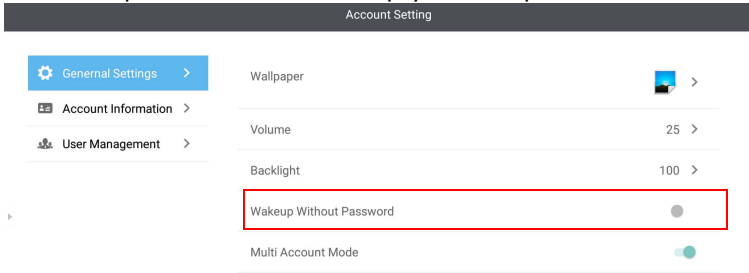

3. Log in as Admin. Set **Multi Account Mode** to off to close the multi-account mode. The maximum number of accounts available is 30.

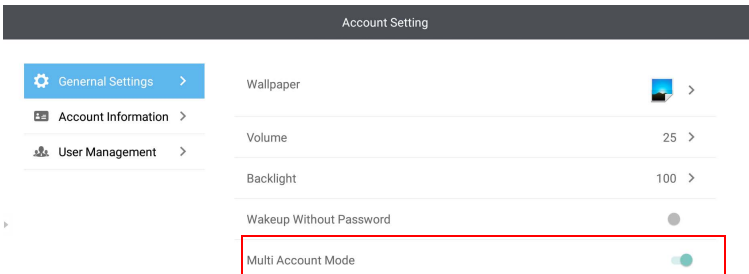

Account Information

1. Under **Account Information**, you can change the password and headshot.

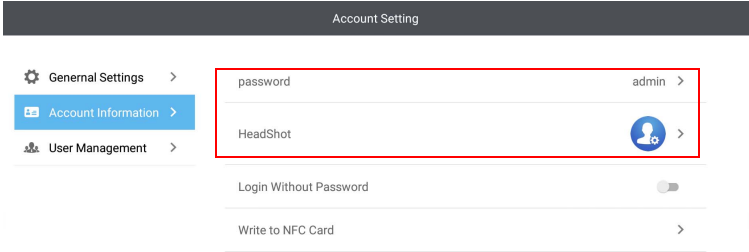

2. Set **Login Without Password** to on, and now you are free from logins.

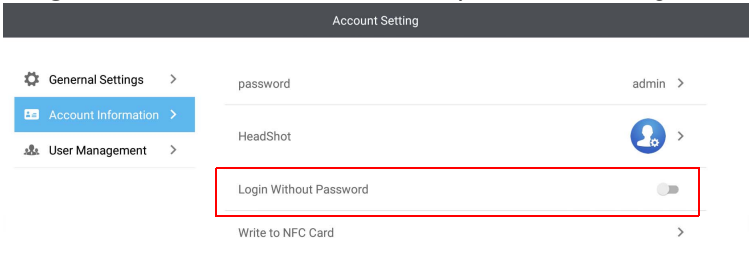

3. Click **Write to NFC Card**, then a dialog window will pop up.

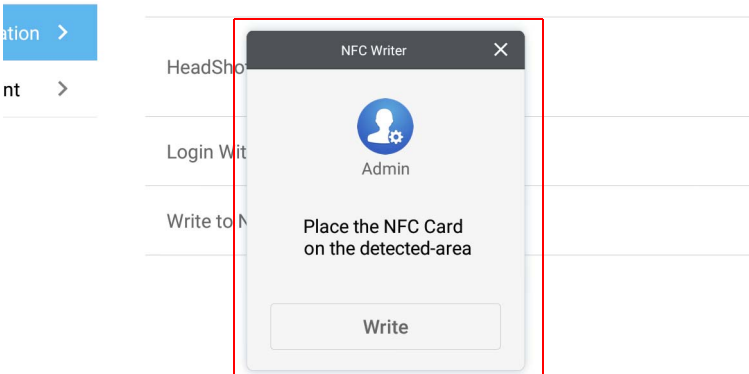

Contact BenQ dealer if you're interested in purchasing the NFC Card.

- Follow the information by placing the NFC Card near the NFC Sensor on the front panel. Now you can have access to NFC function.

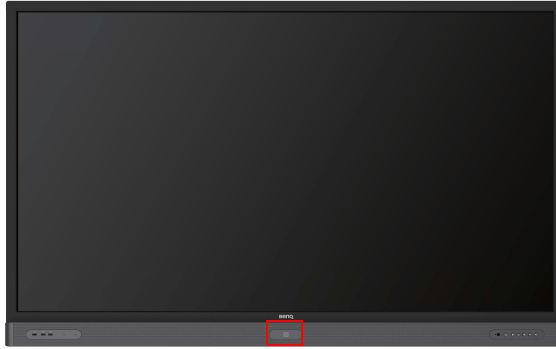

Do not remove the NFC Card from the sensor area until you hear a beep sound and see a dialog window indicating the process is completed.

User Management

Under **User Management**, you can manage users and add new users by clicking **Add User**.

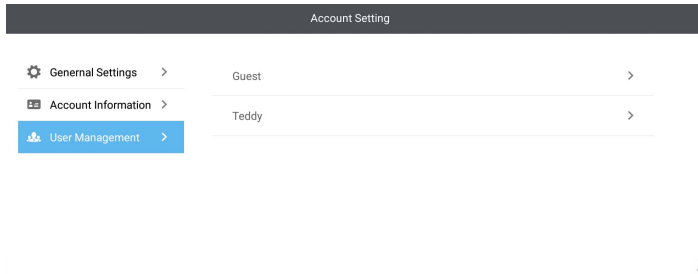

[+ Add User](#)

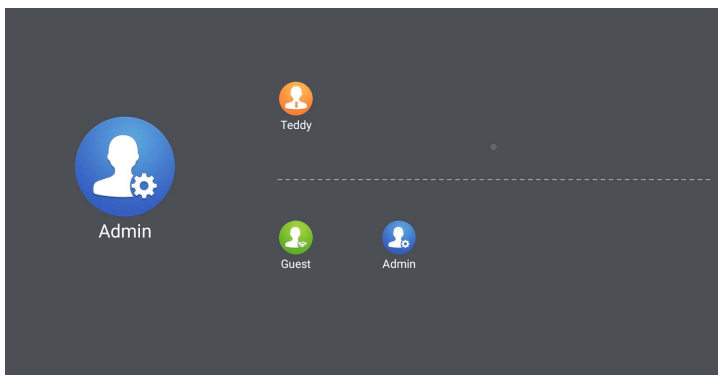

Switching input signals

To select an input signal do either one of the following:

- Press the **INPUT** button on the remote control.
- Press the **Menu** button on the front panel.
- Drag the **General Setting** menu up from the bottom-center of the screen.

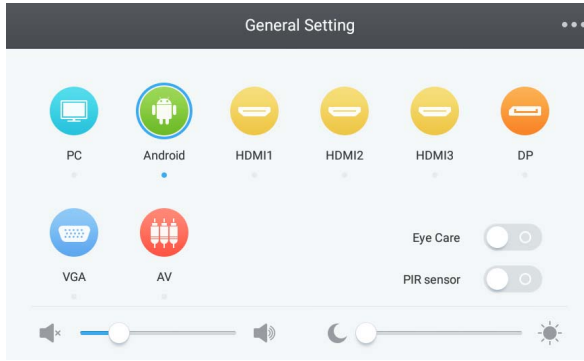

The users can enable the **Eye Care** and **PIR Sensor** (Motion Sensor) function on the OSD menu.

Eye Care solutions

Blue light with wavelengths under 455 nm could affect vision and age the eyes. **Eye Care** solution is designed for eyesight protection: the display provides proprietary eye-care technology with zero-flicker performance and ultra-low blue light emission, preventing eyestrain, eye fatigue and macular degeneration caused by extended sessions in front of a display. In addition, advanced anti-glare screen treatment minimizes distracting reflections and glare for optimal productivity and comfort.



Suggestions for long-term use of the display:

- Rest your eyes for 10 minutes after 30 minutes of continuous use.
- For every 20 minutes of display viewing, look into the distance for 20 seconds.
- When your eyes get sore and strained, close your eyes for a minute and then roll your eyes in all directions.

Downloading software

BenQ may periodically release software updates that may add functions or applications associated with your display. To check if there is a software update available for your device or to obtain the software license key, please visit <http://DSdownload.BenQ.com>. Then enter the serial number (can be found on the sticker attached on the back of the display) and click **OK** to access the Software download page.

Setting up the Internet connection

Your display must be connected to a network to conduct OTA updates or surf the Internet.



To find the MAC address in Android OS, please go to **Setting > Network > Status**.

Network setting

1. On the home screen, select **Apps** (🗪) > **Settings** (⚙️).

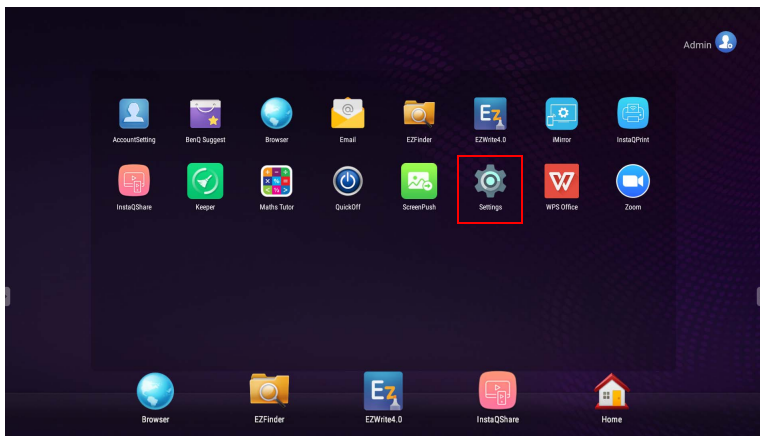

2. Go to **Ethernet**, set the switcher to **On**.

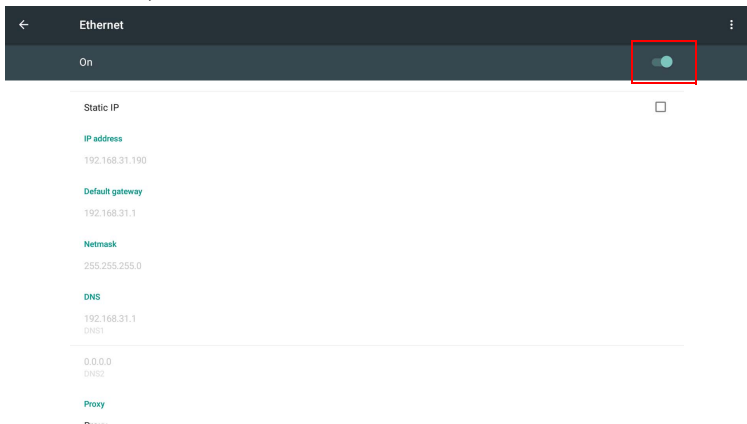

Wireless connection

You must use a wireless internet dongle in order to connect the display to the internet wirelessly. After inserting a dongle to one of the USB ports follow the steps below:

1. Set **Switcher to On** to connect to a wireless network.



To see available networks, turn Wi-Fi on.

2. A list of available networks will show on the screen. Touch the network's name to connect to the network. The password is needed if it is your first time to use the network.

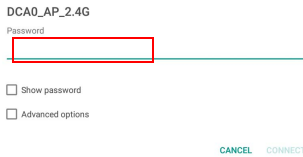

3. Key in the password and press **Connect**. The device is now connected to the WLAN.

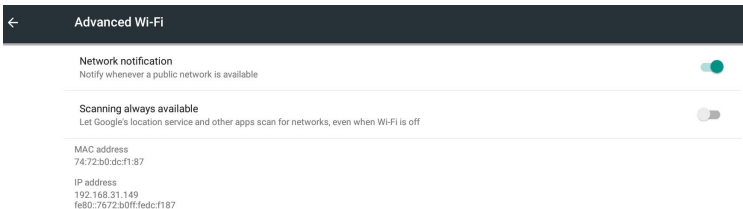
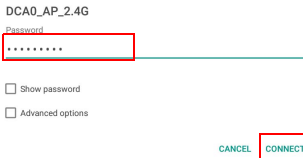

Updating software

Whenever a new version of software is available, the system will automatically detect the update and will prompt you to download it every time you turn on the display. If you want to update the software, choose **NETWORK UPDATE** or **USB UPDATE** to continue the update. Or you can skip this step and update the software later.

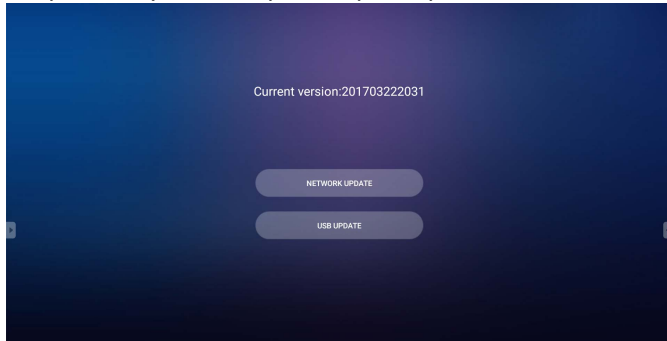

To manually update the software:

1. On the home screen, select **Apps** (🗄️) > **Settings** (⚙️).
2. Go to **About device**, and select **System updates**.

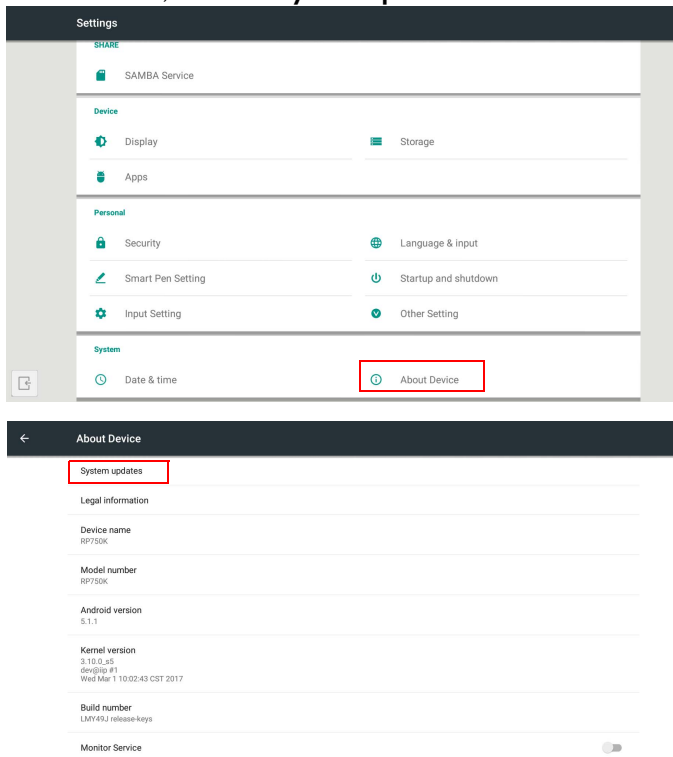



3. If there is an update available, the system will begin updating.



- Software update process may take some time to complete.
 - During the update process, do not turn off the device or disconnect the Internet connection. Any interruptions during the software update process may permanently damage your display.
-

Adjusting audio volume level

To adjust the audio volume level do either one of the following:

- Press **VOL-** / **VOL+** on the remote control to adjust the volume.
- Press  /  on the front panel of the display.
- Use the volume bar on the **General Setting** menu. Refer to [Switching input signals on page 26](#) for more information.



Using the touch screen

You can use the optical touch screen to control your operating system. The touch screen can emulate basic mouse functions and supports multi-touch functions for Windows 7/8*. The following table shows a list of gestures you can use on the touch screen.



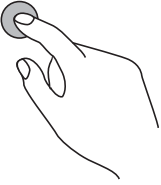
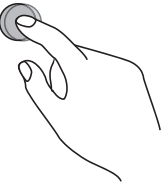
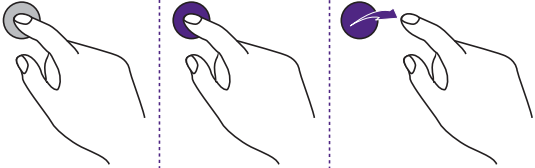
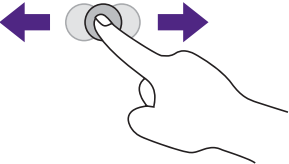

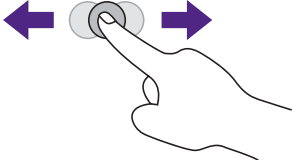
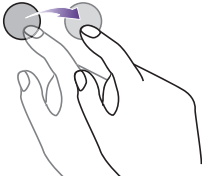
- Ensure that you have installed the USB cable on the display to a computer.
- *Multi-touch functions are only supported by Windows 10, Windows 8, Windows 7 - Home Premium, Professional, Enterprise and Ultimate versions. For Windows XP, Windows Vista, and Windows 7- Starter and Home Basic versions, multi-touch is not supported.
- Windows is a registered trademark of Microsoft Corporation in the United States and other countries.

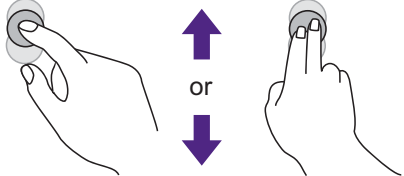
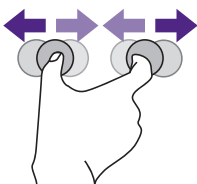
OS functions	Gesture actions
For Windows XP, Windows Vista, Windows 7, Windows 8.1, and Windows 10	
Click	Tap the screen once. 
Double-click	Tap the screen twice. 
Right-click	<ol style="list-style-type: none"> 1. Press on the target. 2. Hold and wait for a blue ring to appear. 3. Release your finger. 
Drag	Drag one finger left or right. 

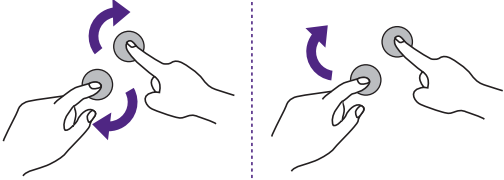
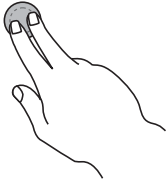
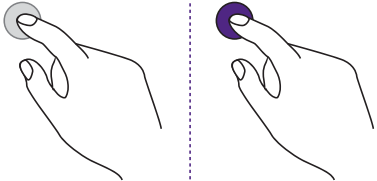
OS functions	Gesture actions
For Windows Vista, Windows 7, Windows 8.1, and Windows 10	
Selection	<p>Drag one finger left or right.</p> 
Pan up / Pan down / Back / Forward	<p>Quickly drag your finger (Flick) in a desired direction.</p> 
Multi-touch functions	
For Windows 7 - Home Premium, Professional, Enterprise and Ultimate versions	
Right-click	<ol style="list-style-type: none"> 1. Press on the target. 2. Tap the screen with another finger. 3. Release the second finger. 
Scrolling	<p>Drag one or two fingers up or down.</p> 
Zoom	<p>Move two fingers apart or toward each other.</p> 

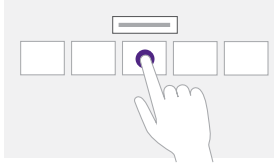
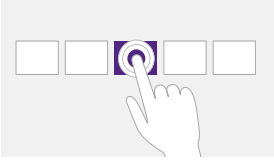
OS functions	Gesture actions
Supported by specific applications	<ul style="list-style-type: none"> • Move two fingers in opposing directions. • Use one finger to pivot around another. 
Supported by specific applications	<p>Tap two fingers simultaneously. The target should be the midpoint between the fingers.</p> 
For Windows XP, Windows Vista and Windows 7	
Wakeup from Windows sleep mode (S3)	<p>Press and hold for 4 seconds.</p> 

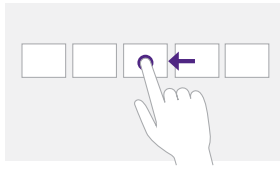
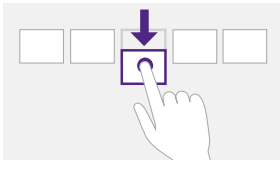
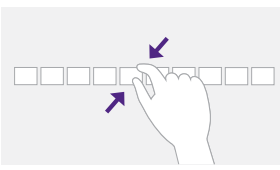
Gesture	Description
For Windows 8	
	<p>Press and hold to learn</p> <p>This touch interaction causes detailed information or teaching visuals (for example, a tooltip or context menu) to be displayed without a commitment to an action. Anything displayed this way should not prevent users from panning if they begin sliding their finger.</p>
	<p>Tap for primary action</p> <p>Tapping on an element invokes its primary action, for instance launching an application or executing a command.</p>

Gesture	Description
	<p>Slide to pan</p> <p>Slide is primarily used for panning interactions but can also be used for moving, drawing or writing. Slide can also be used to target small, densely packed elements by scrubbing (sliding the finger over related objects such as radio buttons).</p>
	<p>Swipe to select, command, and move</p> <p>Sliding the finger a short distance, perpendicular to the panning direction, selects objects in a list or grid (ListView and GridLayout controls). Display the AppBar with relevant commands when objects are selected.</p>
	<p>Pinch and stretch to zoom</p> <p>While the pinch and stretch gestures are commonly used for resizing, they also enable jumping to the beginning, end, or anywhere within content with Semantic Zoom. A SemanticZoom control provides a zoomed out view for showing groups of items and quick ways to dive back into them.</p>
	<p>Turn to rotate</p> <p>Rotating with two or more fingers causes an object to rotate.</p>

Important instructions for using the touch screen

Please clean the frame when there is sign of malfunction on the touch screen.

- Before you clean the screen, make sure the display is turned off, and unplug the power cord.
- Remove dust or dirt from the screen and the infrared plastic filter periodically. It is suggested using a small amount of alcohol to clean the infrared plastic filter.
- To avoid damage to the screen, never use any type of abrasive materials to wipe the screen.
- Use a neutral detergent to clean the touch screen. Avoid using detergents with erosive substance, such as banana oil or ammonia.
- Moisten a clean soft, lint-free cloth with a neutral detergent and then clean the touch screen.
- Do not spray a detergent on the screen surface or the body directly. It may result in a short circuit to the touch screen.
- Keep the touch screen out of direct sunlight or spotlights.

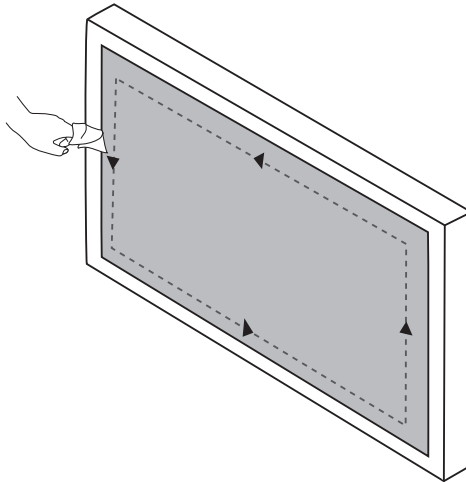

Menu operations

One touch menu operation

Drag the **General Setting** menu up from the bottom-center of the screen, as shown below, to enter the **General Setting** menu.

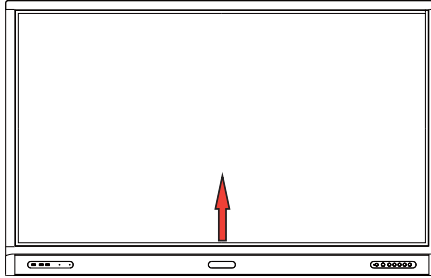

Settings menu

Input settings

Press **INPUT** on the remote control, **Menu** on the front panel, or drag from the bottom middle to the center of the screen to enter the **General Setting** menu.

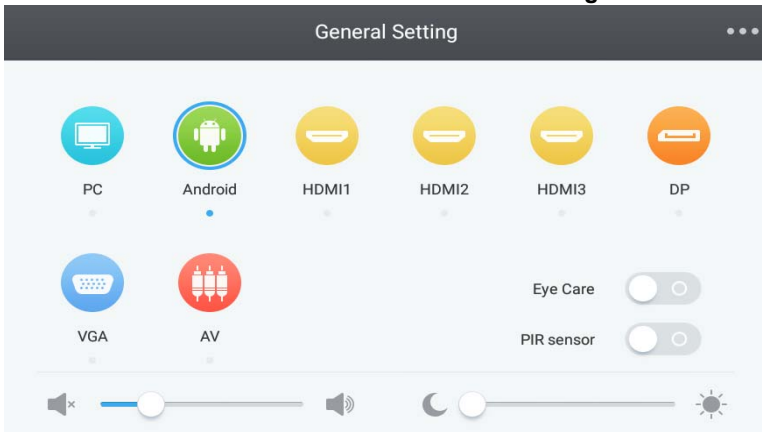

- Press **▲/▼/◀/▶** on the remote control and press **ENTER** on the remote control to confirm, or directly click a desired input source.
- Press **BACK** on the remote control or click a blank area outside the menu to exit the menu.
- You can enable the **Eye Care** function on the OSD menu. **Eye Care** switches the display low blue light mode and activates the flicker free function.
- Use the volume bar to adjust the volume for the display.
- Use the brightness bar to adjust the brightness for the display.

PIR Sensor (Motion Sensor)

- You can enable the **PIR Sensor** function on the OSD menu. **PIR Sensor** allows you to sense motion, often used to detect if a human has moved in or out of the sensor's range.
- The display automatically turns on **Eye Care** and dims the brightness of the screen when a human is walking in front of the sensor.



The performance of **PIR Sensor** would be limited by the environment and objects around.

Audio settings

Click **•••** on the **General Setting** menu to enter the **Audio** menu.



- Press **▲/▼/◀/▶** on the remote control and press **ENTER** on the remote control to confirm or directly click an item.
- Press **BACK** on the remote control or click a blank area outside the menu to exit the menu.

Menu	Description
Volume	Drag the knob to adjust the volume.
Bass	Drag the knob to adjust the bass.
Treble	Drag the knob to adjust the treble.
Balance	Drag the knob to adjust the balance.
Sound Environment	Touch a preset sound environment. Options are Standard , Meeting , Class , or Custom .

- Press **MUTE** on the remote control or directly click  to enable or disable **Mute**.

Screen settings

Click **•••** on the **General Setting** menu to enter the **Screen** menu.

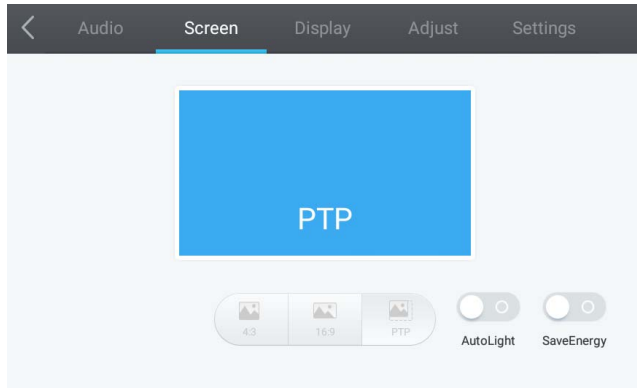

- Press **▲/▼/◀/▶** on the remote control and press **ENTER** on the remote control to confirm or directly click an item.
- Press **BACK** on the remote control or click a blank area outside the menu to exit the menu.
- Press **◀ / 4** on the remote control and press **ENTER** to adjust image.

Menu	Description
Aspect ratio	Press ◀ / ▶ on the remote control or click an aspect ratio. Options are 4:3 , 16:9 , or PTP .

- click  to enable or disable **AutoLight** and **SaveEnergy**.
- **AutoLight** detects the ambient light of your room and automatically adjust the screen brightness.
- **SaveEnergy** reduces the screen brightness of the display to save power.
- The display automatically enters energy saving mode when no one is detected within the sensor's range.
- The display automatically turns off when no one is detected within the sensor's range for a long period of time.

Display settings

Click **•••** on the **General Setting** menu to enter the **Display** menu.



- Press **▲/▼/◀/▶** on the remote control and press **ENTER** on the remote control to confirm or directly click an item.
- Press **BACK** on the remote control or click a blank area outside the menu to exit the menu.

Menu	Description
Brightness	Press VOL+ / VOL- on the remote control or drag the knob to adjust the brightness.
Contrast	Press VOL+ / VOL- on the remote control or drag the knob to adjust the contrast.
Hue	Press VOL+ / VOL- on the remote control or drag the knob to adjust the hue.
Sharpness	Press VOL+ / VOL- on the remote control or drag the knob to adjust the sharpness.
Picture Mode	Press VOL+ / VOL- on the remote control or click a picture mode. Options are Standard , Bright , Soft , and Custom .
Color Temp.	Press VOL+ / VOL- on the remote control or click a preset color temperature for the image. Options are Standard , Cold , or Classroom .



There is no **Hue** and **Sharpness** for HDMI and VGA settings.

Adjust settings (VGA-only)

Use the **H Position**, **V Position**, **Clock**, and **Phase** functions to manually adjust the image.

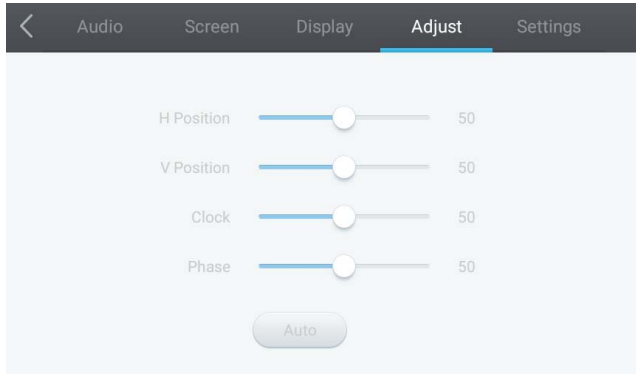

Menu	Description
H Position	Press to move the screen to the left or right.
V Position	Press ENTER on the remote control or click the switch to lock or unlock the remote control IR sensor on the front panel of the display.

More settings

Click **•••** on the **General Setting** menu to enter the **Settings** menu.

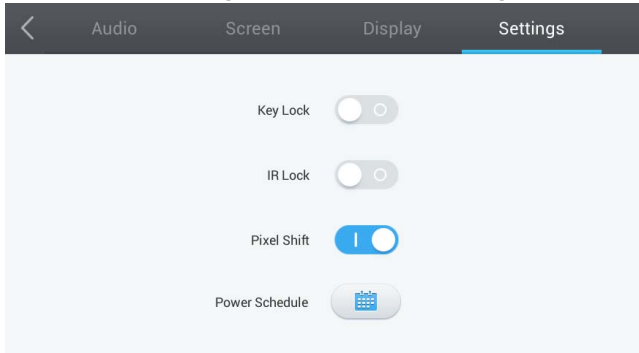

- Press **▲/▼/◀/▶** on the remote control and press **ENTER** on the remote control to confirm or directly click an item.
- Press **BACK** on the remote control or click a blank area outside the menu to exit the menu.

Menu	Description
Key Lock	Press ENTER on the remote control or click the switch to lock or unlock the buttons on the front panel of the display.

IR Lock	Press ENTER on the remote control or click the switch to lock or unlock the remote control IR sensor on the front panel of the display.
Pixel Shift	Press ENTER on the remote control or click the icon to set a pixel shift preventing from image retention.
Power Schedule	Press ENTER on the remote control or click the icon to set a power schedule.



- The **Key Lock** and **IR Lock** functions cannot be enabled at the same time.
 - For image retention, please see [Notes on the LCD panel of this display on page 2](#) for more information.
-

System settings

On the home screen, click **Apps**  > **Settings**  to enter system settings.

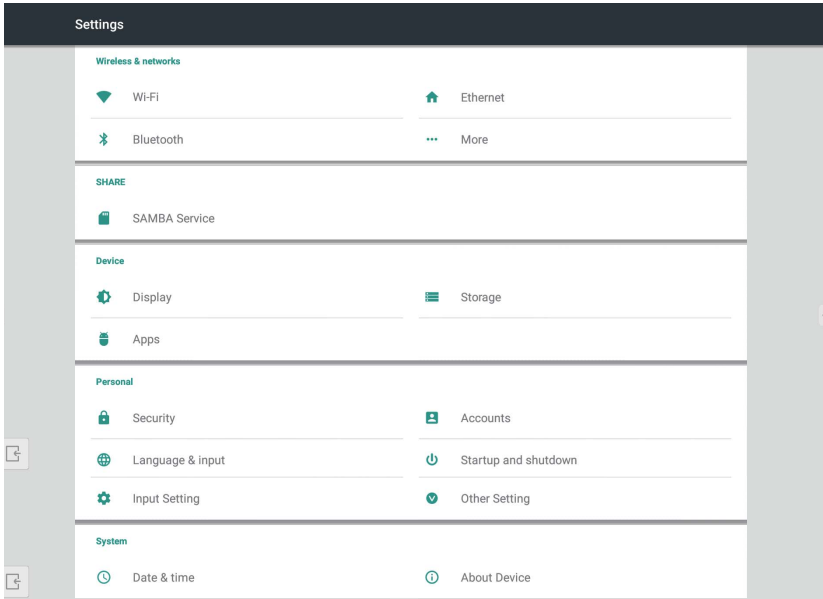

- Press **BACK** on the remote control or click a blank area outside the menu to exit the menu.

Options	Description
Wi-Fi	Click to set Wi-Fi. Refer to Wireless connection on page 28 for more information.
Ethernet	Click to set Ethernet. You can see the Internet connection information here. Refer to Network setting on page 27 for more information.
More	Click to access more functions.
SAMBA Service	Click to retrieve file for clients using the SMB/CIFS (Server Message Block/Common Internet File System) protocol. You can share the folders in IFFPs or in devices within the same domain (e.g. PCs or NBs). To download data in IFFPs to PCs, establish a connection through the IP address. You can set a password for the account for account security.
Display	Click to set visual preferences on Font size and Wallpaper .
Storage	Click to show empty and occupied space.
Apps	Click to view memory consumption of apps in Android.
Security	Click to access the advanced system security settings.
Accounts	Click to manage the email account. You can add new accounts and delete existing accounts here.

Language & input	Click to set Language and Keyboard & Input Methods in Android.
Startup and shutdown	Click to set the Startup channel , Built-in PC startup option , Standby after startup , and Timer switch . Refer to Startup and shutdown on page 45 for more information.
Input Setting	Click to change the name of input sources.
Other Setting	Click to open and close the floating tool.
Date & time	Click to set date, time, and their formats in Android.
About device	Click to view system information in Android.



The amount of available storage space for the user varies according to the amount of pre-installed apps and images occupying the total storage space.

Proxy setting

- Click **Proxy Auto-Config** under **Proxy**.

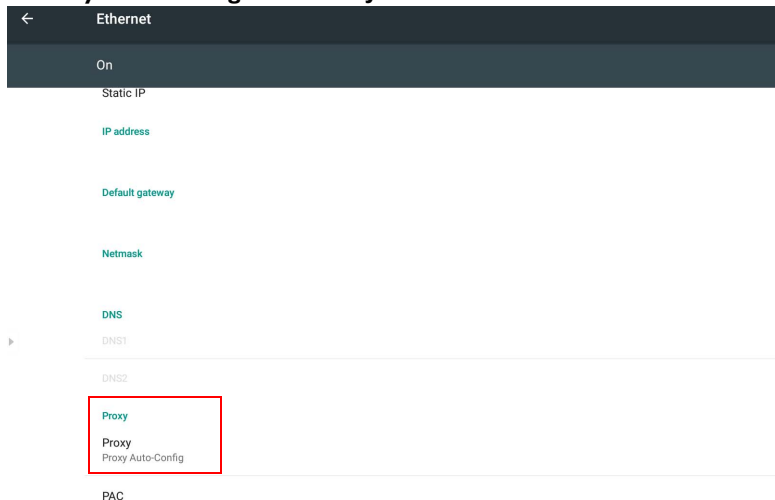

- Start **PAC** (Proxy Auto-Config) setting web address to bring in the PAC-File.

PAC

<https://www.example.com/proxy.pac>

CANCEL OK

- Click **Manual** under **Proxy**.

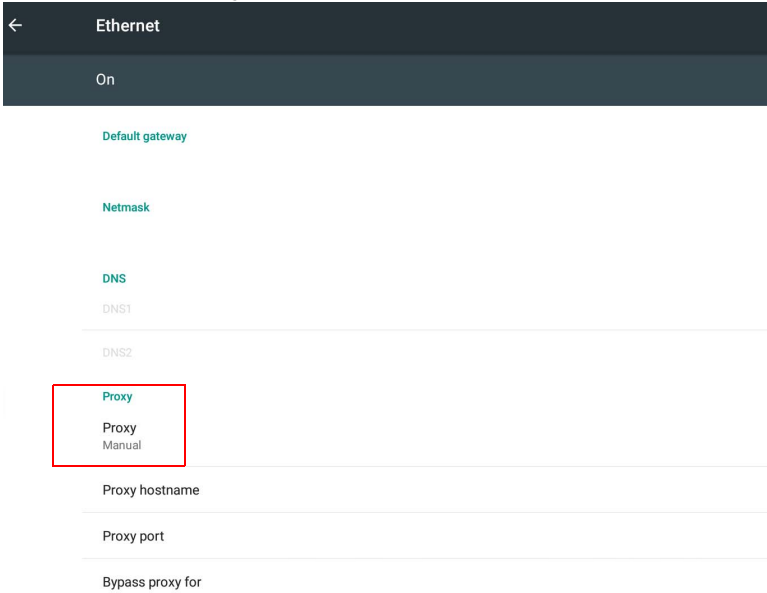

Options	Description
Proxy hostname	Enter the proxy server name.
Proxy port	Enter the using channel. Proxy port <input data-bbox="437 943 930 1011" type="text" value="8080"/> CANCEL OK
Bypass proxy for	For local server address only. Bypass proxy for <input data-bbox="442 1200 935 1268" type="text" value="example.com,mycomp.test.com,localhost"/> CANCEL OK

Startup and shutdown

- Click **Startup and shutdown** on the **Settings** menu. For **Startup channel**, you can choose **Last shutdown channel** or **Default startup channel**.

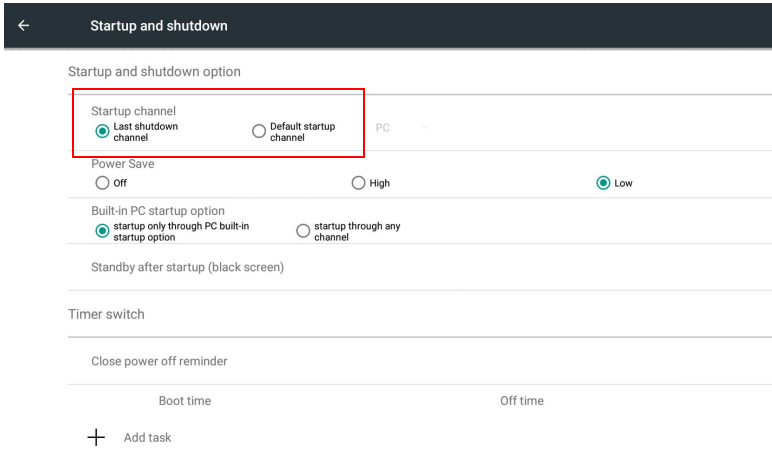

- Under **Default startup channel**, you can choose from a variety of channel types.

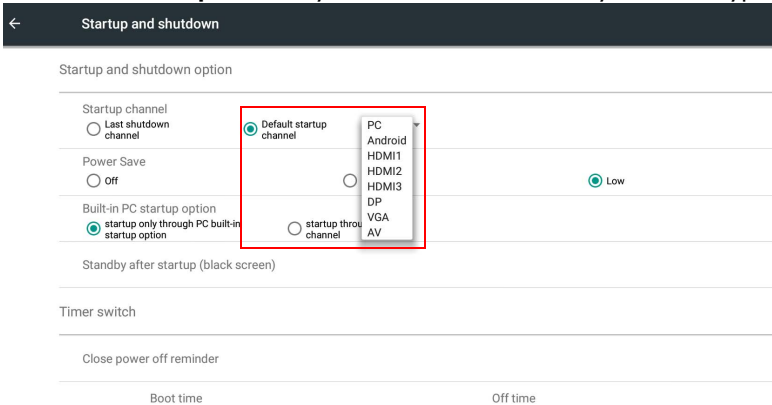

- For **Built-in PC startup option**, (1) open the OSD menu, select PC, and start PC built-in. (2) PC Built-in is set to start up automatically when the IFP boots.

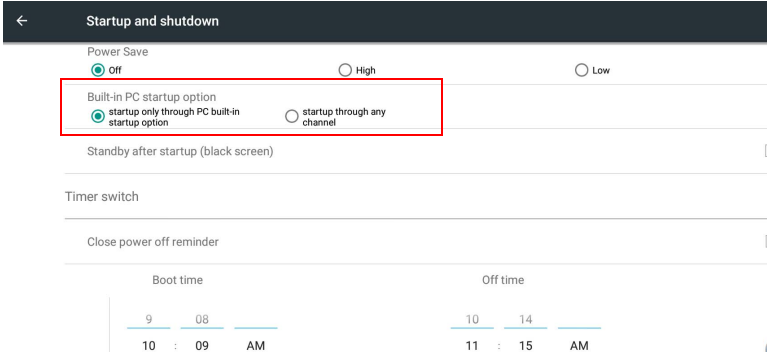

- For **Timer switch**, reminders include boot time and off time. Schedules can be made by choosing the days of the week.

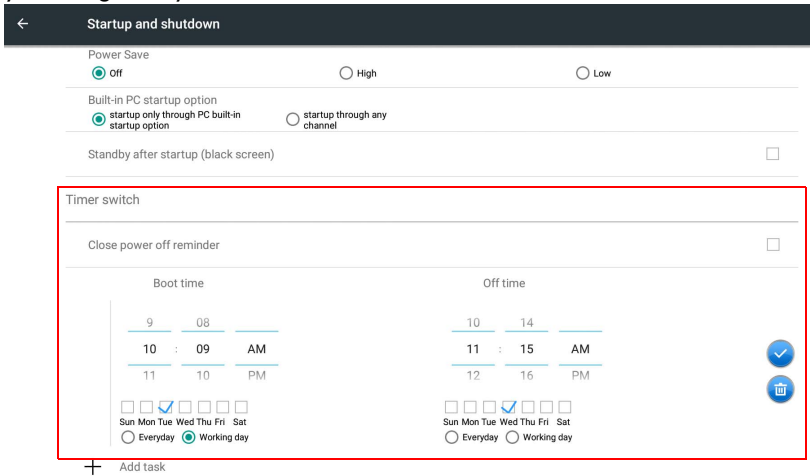

Android system interface



Note that this is a closed Android OS. Download and use of unauthorized apps on this system are not available.

Main interface

The display launches the Android main interface by default.











To navigate the Android main interface:

- Press **◀ / ▶** on the remote control to select icons at the bottom and press **ENTER** to execute the program, or directly tap the icon.
- Press **HOME** on the remote control or Home button on the front panel to return to the main interface.
- Press **INPUT** on the remote control or drag the **General Setting** menu up from the bottom-center of the screen to enter the **General Setting** menu to select an input.

Floating Annotation Toolbar

The Floating Annotation Toolbar is a convenient function that allows you to quickly write or create annotations on any screen that the display is showing. Under any input source or in the Android interface, touch and hold two fingers spaced about 20 – 50 mm apart on the screen for more than two seconds to launch the Floating Annotation Toolbar menu as shown below.



Icon	Function	Description
	Close and Move	Long press this button to drag and move the Floating Annotation Toolbar around. You can also click the button to close the floating toolbar and clear all the brushes.
	Whiteboard	Click to start EZWrite 4.0.
	Annotate	Click to switch the color of the brush. Color options are blue, red, green, and black.
	Clear All	Click to erase all annotations on the screen.  You may also quickly erase any annotations made by wiping any writing or drawings on the touchscreen using a balled-up fist.
	File Folder	Click to open the files.
	Screenshot	Click to take a screenshot of the entire screen, including the handwriting.
	Print Screen	Click to take a screenshot of the entire screen and print it.

EZFinder

EZFinder helps users browse for files in stored in the internal storage of the Android system or external storage connected to the display.

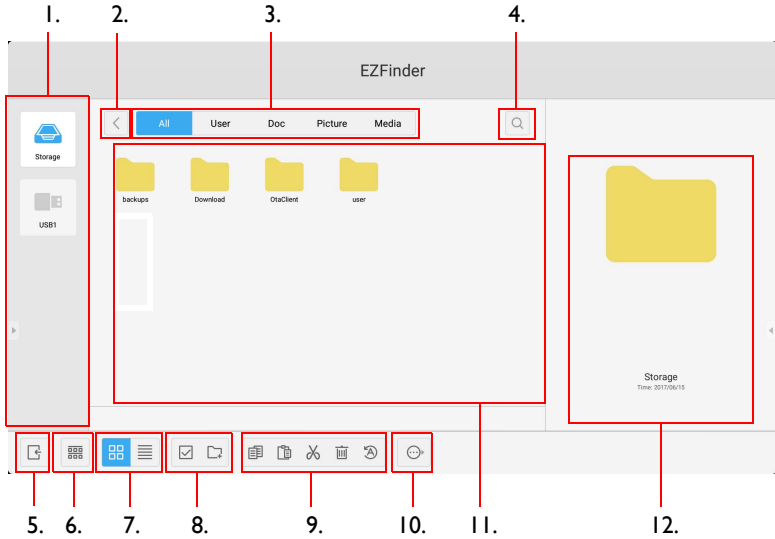

Item	Function	Description
1	Storage device	Click to select either internal or external storage to browse.
2	Return	Click to return to the previous folder.
3	File type filter	Click to highlight the desired file type to display.
4	Search	Click to search for files in the storage device.
5	Exit	Click to exit EZFinder.
6	Sort	Click to sort the files shown in EZFinder. Sorting options include Name , Type , Size , and Time .
7	Thumbnail/List	Click to view files either in thumbnail or list view.
8	Select/Add Folder	Click to select multiple files or add a folder. 💡 When the Select button is clicked it will become a Cancel button, and the Add Folder button will become a Select All button.
9	File operation	Perform operations such as copy/paste/cut/delete/rename. 💡 The file operation buttons will only appear when a file is selected.
10	Send	Click to quick send a selected file to another storage device.

11	Main display area	Displays files of corresponding type stored in the selected storage device. Click to select a file
12	File preview	Displays a preview of the selected file along with file details

Multimedia files such as images, audio files, and videos can be played by directly tapping on the file icon.

Image

Select an image file you want to show on the display and perform any of the functions shown on the screen.

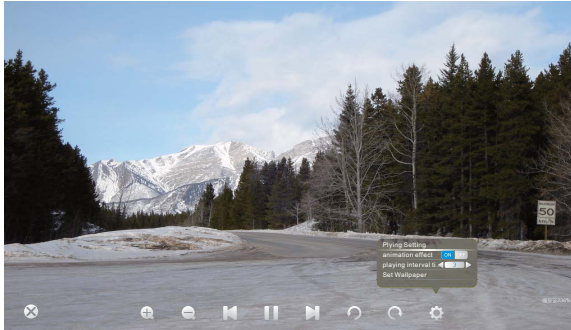

Icon	Function
	Close the current playback.
	Magnify the current image.
	Shrink the current image.
	Play the previous image.
	Play/pause the current playback.
	Play the next image.
	Rotate the current image counter-clockwise.
	Rotate the current image clockwise.
	Set the animation effect and playing interval for images being played, and set the current image as the wallpaper.







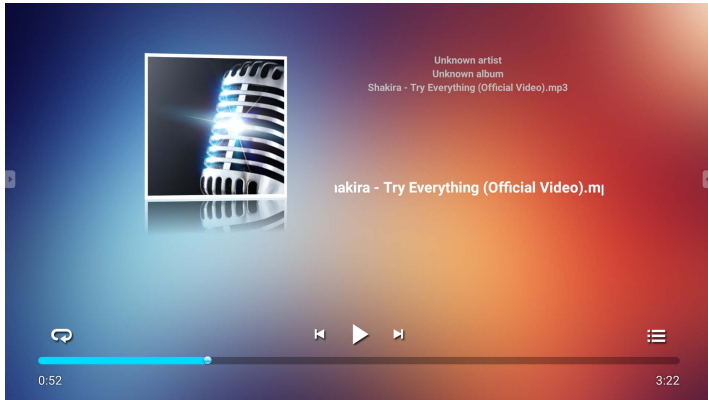

Supported image format (max resolution):

- JPEG (base-line up to 8K x 8K, progressive up to 4K x 4K)
- PNG (8K x 8K)
- BMP (8K x 8K)
- GIF (4K x 4K)

Audio

Select an audio file you want to play and perform any of the functions shown on the screen.



Icon	Function
	Repeatedly play audio files in the playlist.
	Repeatedly play a single audio file in the playlist.
	Play the previous audio file.
	Play/pause the current playback.
	Play the next audio file.
	Check audio files in the playlist.



Supported audio format (codec):

- wma (WMA/WMAPro: 128Kbps~320Kbps, 8KHz~48KHz sampling rate)
- mp3 (MPEG Layer 3: 32Kbps~320Kbps, 32KHz~48KHz sampling rate)
- wav (PCM: Max 320Kbps, Max 48kHz sampling rate / ADPCM: 384Kbps, 8KHz ~ 48KHz sampling rate)
- m4a (ACC: 24kbps ~ 384kbps, 16KHz~48KHz sampling rate)
- ogg (Vorbis: Max 320Kbps, 8KHz~48KHz sampling rate)

Video

Select a video file you want to play on the display and perform any of the functions shown on the screen.

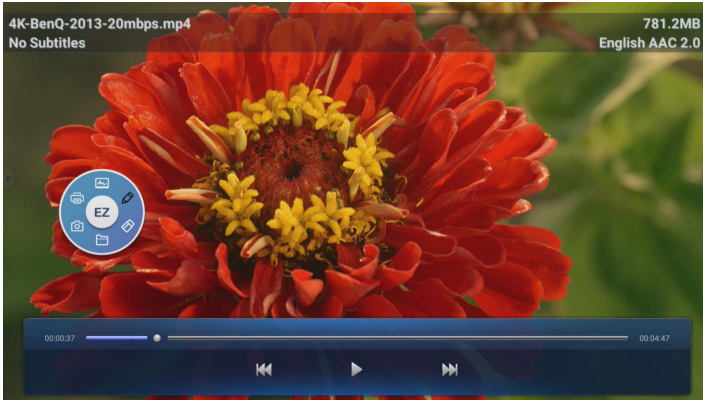

Icon	Function
	Fast rewind the current video.
	Play/pause the current playback.
	Fast forward the current video.



Supported video format (codec) up to 4K resolution:

- 3gp (H.264 MP, HP@Level 4.1, H263, MPEG-4 SP@L0-3, ASP@L0-5)
- avi (MPEG-1, MPEG-2 MP@HL, MPEG-4 SP@L0-3, ASP@L0-5, H.264, MP, HP@Level 4.1, H263, VP6, MJPEG)
- mkv (VP9, H.265)
- mov (MPEG-4 SP@L0-3, ASP@L0-5, MJPEG, H.264 MP, HP@Level 4.1, H265)
- mp4 (MPEG-4 SP@L0-3, ASP@L0-5, H.264 MP, HP@Level 4.1, H265)
- mpg, mpeg (MPEG-1, MPEG-2 MP@HL, H.264 MP, HP@Level 4.1)
- ts (MPEG-2 MP@HL, MPEG-4 SP@L0-3, ASP@L0-5, H.264 MP, HP@Level 4.1, VC1 AP, H265)

Browser

When connected to a network, click on the browser icon to surf the Internet. Click on the symbol **X** in the upper left corner to close it.

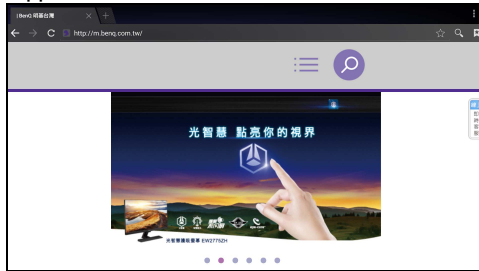

Menu

Menu is the shortcut to settings menu. Refer to [Settings menu on page 36](#) for details.

APPS

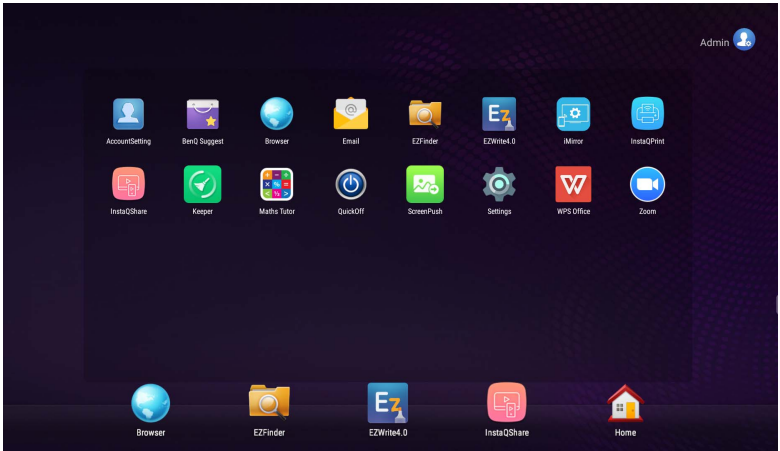

- Other than preset apps located at the bottom of the screen, additional apps will be displayed at the top of the screen when the App icon is clicked.
- For more information about **Quickoff**, please see [Turning off the display by Quickoff on page 21](#).

BenQ Suggest

Tap  to launch **BenQ Suggest**. With this application, you can view apps suggested by BenQ for download.

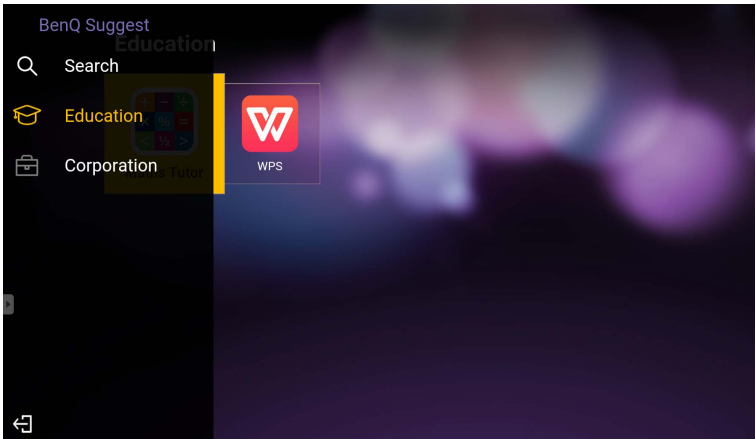

Tap the category on the left panel to browse the suggested apps. Tap an app from the selected category to view a basic description of the app.

Function	Description
Search (🔍)	Tap to search for an app.

Education (🎓)	Tap to show the suggested apps in the Education category.
Corporation (📁)	Tap to show the suggested apps in the Corporation category.
Exit (⏪)	Tap to close BenQ Suggest .

InstaQShare

Tap  to launch **InstaQShare**. With this application, you can mirror the display's screen on your smartphone or tablet for hands-on annotation, mirror the screen of your smartphone or tablet on the display, or transform your smartphone or tablet into a remote control for the display.



Before launching the application, make sure your display is properly connected to Internet.

The image shows the InstaQShare setup screen. At the top right, there is a phone number '770-992'. The main heading is 'Seamless Sharing Across all Fields'. Below it, a paragraph states: 'InstaQShare facilitates intuitive and instant wireless presentation that supports smooth content transmission. This makes business or education presentation easier and simpler than ever.' To the right, there is a graphic of a laptop displaying a world map and a smartphone displaying a similar map. Below this, there are three main steps:

- Network Connect:** Make sure your device is connected to the same network with IFFP.
- Install App:** Visit "http://192.168.31.135:8000" with web browser or scan the QR-code to download and install app.
- Click to connect:** Launch InstaQShare and click "InstaQShare-4920" to connect.

At the bottom right, there is a 'Setting' icon.

To use **InstaQShare**:

1. Make sure your mobile device (such as smartphone or tablet) and the display are connected to the same Wi-Fi network.
2. Scan the QR code to download and install the **InstaQShare** app on your mobile device.
3. Open the **InstaQShare** app on your mobile device, and then click the **InstaQShare** ID name that you want to connect to.
4. Enter the password shown on the upper right corner of the display.
5. Once the mobile device has successfully connected to the display, a confirmation message will appear on the display. Tap **Allow** on the display to confirm the connection.
6. Once connected you can:
 - Mirror the display's screen on your mobile device, by tapping **Screen Mirroring** on your mobile device.
 - Mirror the device's screen on the display, by tapping [] on your mobile device.

- Operate the display by using your mobile device as a remote control.



Once connected, any operations on the display or mobile device will also show up on your mobile device and display.

You can also tap **Setting** (⚙️) in the lower right corner of the display to modify the settings for **InstaQShare**, such as the **InstaQShare** ID name, password, or mirroring confirmation message.

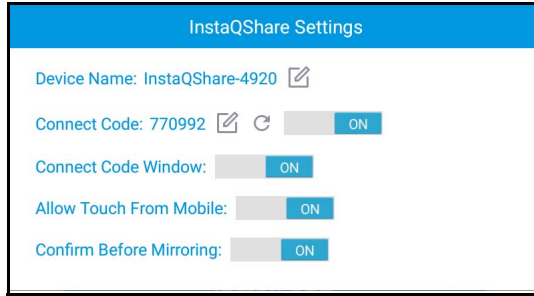

InstaQPrint

Tap  to launch **InstaQPrint**. With this application, you can print a file or website image using a Wi-Fi or remote printer.



Before launching the application, make sure your display is properly connected to Internet.



1. Tap the option on the left panel and browse and select the desired file, photo, page, or image you want to print.
2. Tap **Manage Printers** to choose which printer that you want to use.
3. To select a printer:
 - Tap an option from the list of available printers on the left panel.
 - Tap **Scan for Wi-Fi Printers** to search for printers automatically.

- Tap **Manual Setup** to add a new printer manually.

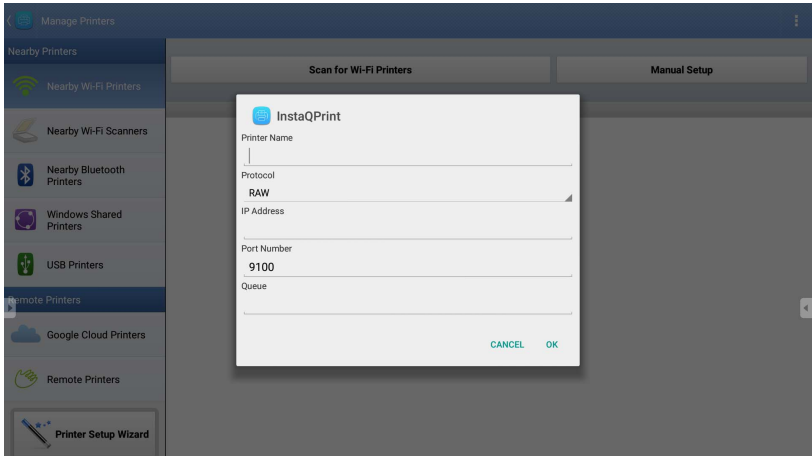

WPS Office

Tap **W** to launch **WPS Office**. With this application, you can open document files including PDFs as well as Microsoft Word, PowerPoint and Excel documents.

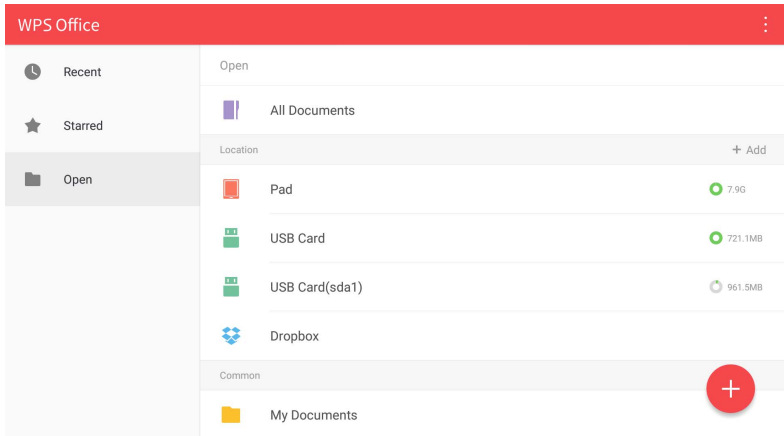

To edit a file with **WPS Office**:

1. Tap **Open** (📁) on the left panel to browse and open a file located in either the display's internal memory, an external storage device, or cloud storage.
2. Tap the function menu on the top panel to access the file format's various functions.



The description below is for a Powerpoint file, the function menus for other file formats will vary.

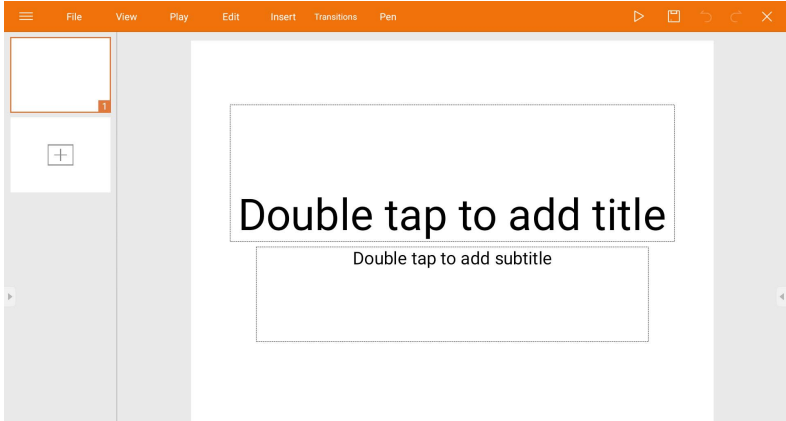

Function	Description
File	Tap to open, save, share, print, and manage your presentations.
View	Tap to change or edit the presentation views.
Play	Tap to start or set up a slide show.
Edit	Tap to edit the content or format of the slides.
Insert	Tap to insert tables, pictures, charts, comments, video, or audio.
Transitions	Tap to apply or adjust the timing of a transition.
Pen	Tap to write, draw, paint or sketch to the slides.
Play (▷)	Tap to start a slide show.
Save As (☐)	Tap to save the presentation file on either the display's internal memory, an external storage device, or cloud storage.
Undo (↶)	Tap to undo an action.
Redo (↷)	Tap to redo the last action.
Close (✕)	Tap to close the presentation file.
Back (←)	Tap to return to the previous page.
Next (→)	Tap to go to the next page.
Exit (↶)	Tap to exit WPS Office .

Supported Office versions and file formats

Supported Office versions: 97 / 2000 / XP / 2003 / 2007 / 2010

Supported Office software formats:

Office Software	Supported File Formats
Word	wps / wpt / doc / docx / dot / dotx / txt / log / irc / c / cpp / h / asm / s / java / asp / bat / bas / prg / cmd
Excel	et / ett / xls / xlsx / xlt / xlsx / csv / xlsx / xltm
PowerPoint	ppt / pptx

Keeper

Tap  to launch **Keeper**. With this application, you can optimize the system's performance by tidying up file systems. Tap **One Key Optimize** to optimize memory. You can also tap **Memory Clean** and **Garbage Clean** to clean up unwanted files.

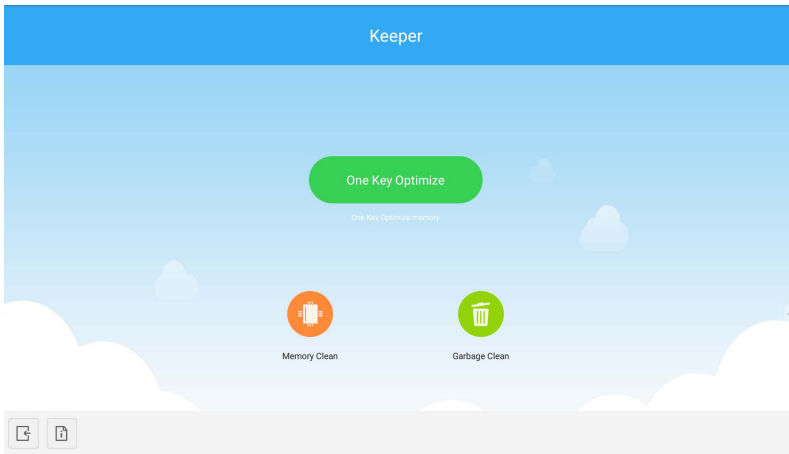

Screen Push

Tap  to launch **Screen Push**. With this application, you can duplicate your screen on multiple IFPs by connecting your IFP with other IFPs in the same LAN.

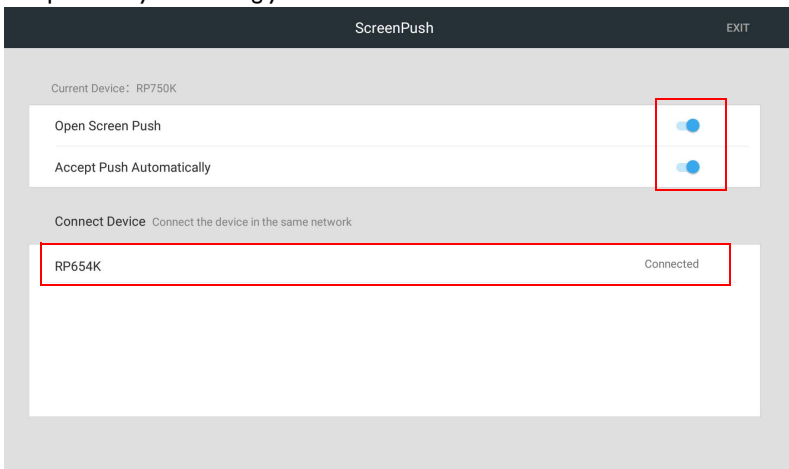

1. Swipe to unlock **Open Screen Push** and **Accept Push Automatically**.
2. Connected device will be shown on the screen.
3. Your screen will be duplicated to other IFPs in the same LAN.

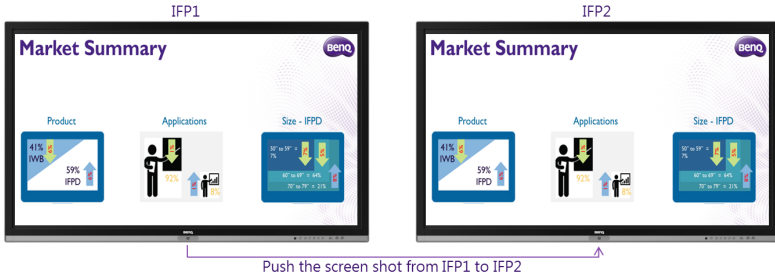

Maths Tutor

Maths Tutor provides simple, interactive and informative content with full curriculum alignment for teachers to enhance the learning experience.

- Tap  to launch **Maths Tutor**.
- Not simply game-based, **Maths Tutor** provides a complete solution for users to learn, practice and assess important numeracy skills.

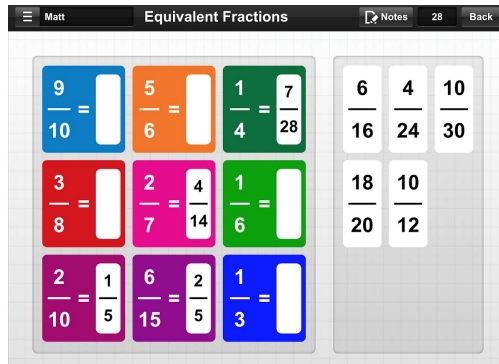
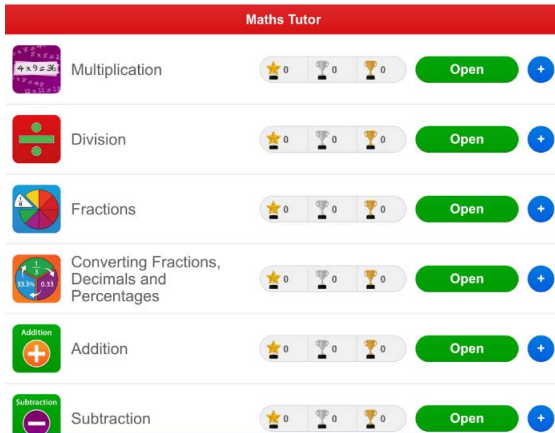



All topics in the app include a section for users to track their progress and assess their level of understanding.

- You can also use your mobile device to scan the QR code to join the app. Make sure your mobile device is in the same LAN with the IFP.

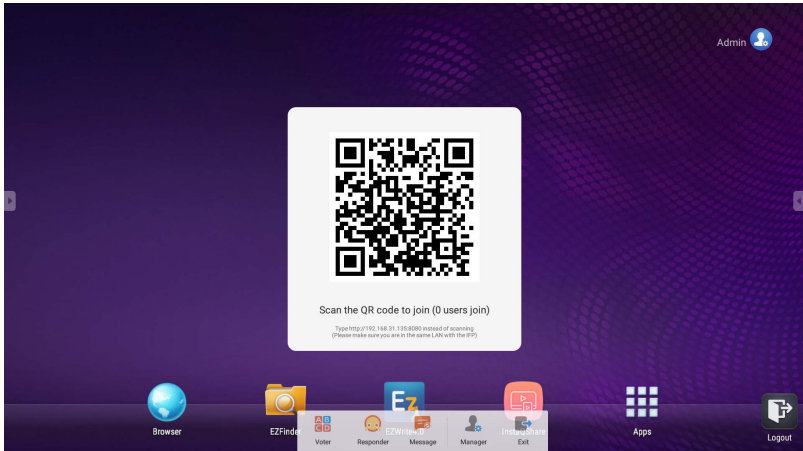

Email

- Tap  to launch **Email**.
- To use **Email**, set up an account first. Type your Email address and click **NEXT**.

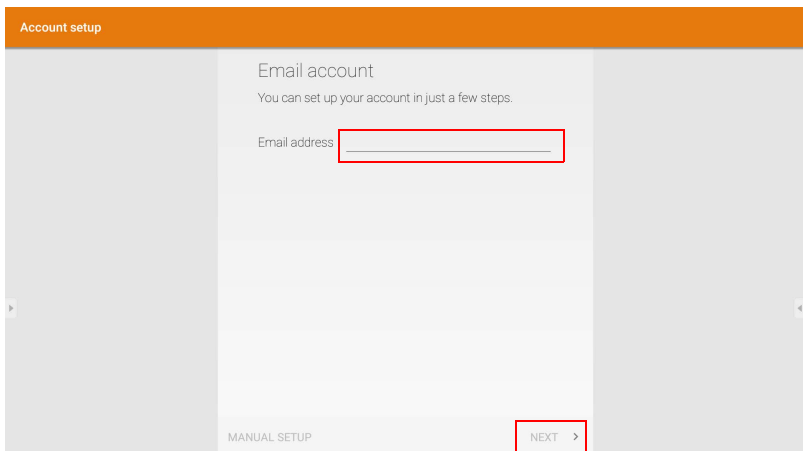

- After you've signed up, you will receive a verification email.

- After you respond to the Email verification, you can begin writing email.

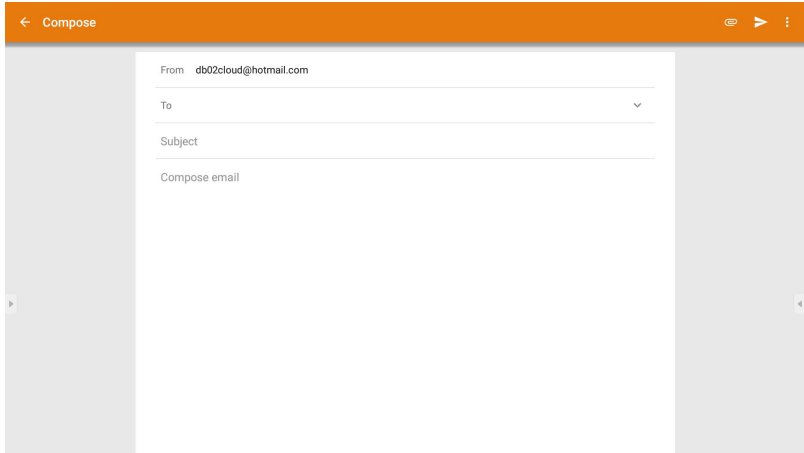

Side Tool Bar

Side Tool Bar gives you access to a number of tools to help you work with your display.

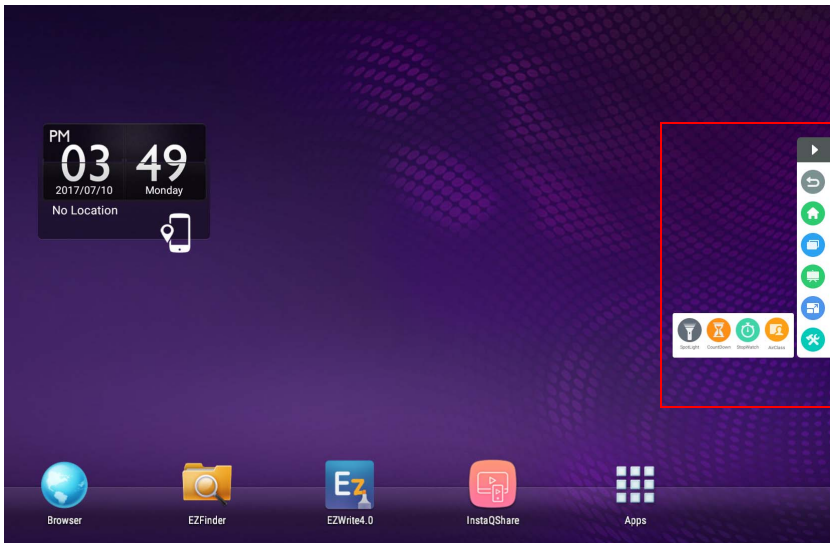

Function	Description
Return (↩)	Tap to return to previous operation interface.
Home (🏠)	Tap to return to Home interface.
Shortcut (🗨)	Tap to pop up Shortcut menu.
EZWrite 4.0 (📝)	Tap to enter EZWrite 4.0 software.

Color (🎨)	Tap to change pen colors.
SpotLight (🔦)	Tap to open SpotLight .
CountDown (⌚)	Tap to open CountDown function.
StopWatch (⌚)	Tap to open StopWatch function.
AirClass (📺)	Tap to open AirClass function.

Zoom

Zoom is a video-conferencing app that is installed in the display by default. It allows you to conveniently conduct video conference meetings with any other **Zoom** users.

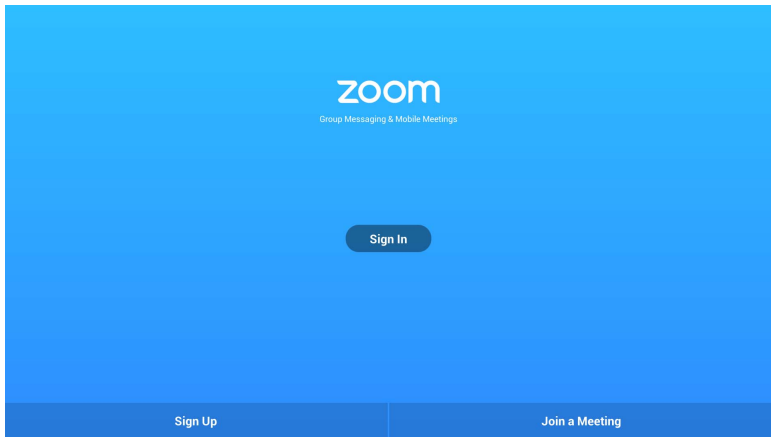

For free plan users of **Zoom** (📺), please visit <https://zoomnow.tw/live/?benq> to upgrade your plan to a paid plan. Read more information on the website.

1. On the home screen, select **Apps** (🗃️) > **Zoom** (📺)
2. Select **Sign In** if you want to create a new meeting, select **Join a Meeting** if you want to join an already created meeting.
 - After signing in, create a meeting ID which will be the meeting ID other users will enter to join the meeting.
 - If joining a meeting, enter the meeting ID provided by the creator of the meeting in the Join a Meeting page.

Product information

Specifications

		Specifications
		RP654K / RP704K / RP750K / RP860K
LCD panel	Light source	DLED
	Panel size	RP654K: 65"; RP704K: 70" RP750K: 75"; RP860K: 86"
	Pixel pitch (mm)	RP654K: 0.372*0.372 RP704K: 0.40075*0.40075 RP750K: 0.429*0.429 RP860K: 0.4935*0.4935
	Native resolution (pixels)	3840*2160
	Brightness (cd/m ²) (typical)	RP654K: 350 (typ) RP704K/ RP750K/ RP860K: 330 (typ)
	Contrast ratio (typical)	RP654K/ RP750K/ RP860K: 1200:1 RP704K: 4000:1
	Response time (ms) (typical)	8 (typ)
	Panel Bit	Dithering 10 bit
Touch	Technology	Infrared Technology
	Touch Method	Finger & Stylus
	Resolution	32767*32767
	Capacity	10 points writing/ 20 points touching (varies from operating systems and applications)
	Accuracy	+/- 2mm over 90% of touchable area
	Touch Output	USB type B x 2
	Operating System	Windows/ Linux/ Mac/ Android/ Chrome (touch function varies from releases)
Panel glass	Tempered glass	AG 80 Coating
	Thickness (mm)	4
Input	Computer	VGA (D-Sub 15-pin) x 1
	Video	Composite Video (3-in-1 connector) x 1, HDMI IN 1.4 x 2, HDMI IN 2.0 x 1, HDMI OUT x 1
	Audio	Line-in (3.5 mm jack) x 1 along with 1 VGA input, Composite Audio L/R x 1
	USB	Type A x 6 (one onboard USB 3.0)
	Control	RS-232C (D-Sub 9-pin) x 1
	TV Tuner	NO

Output	Computer	NO		
	Video	NO		
	Audio	Earphone out X1, COAX x 1		
	External speaker out (L/R)	NO		
Audio	Audio W (Amp)	16W x 2		
	Internal speaker	YES		
Power	Supply	100 - 240V AC, 50 - 60 Hz		
	Consumption Max.	RP654K: 300W (without PC) RP704K: 400W		
		RP750K: 450W (without PC) RP860K: 530W (without PC)		
Consumption Standby		<0.5W		
Environment				
Environment	Operating Temperature	0 - 40°C		
	Operating Humidity	10 - 90% (without condensation)		
	Storage Temperature	-10 - 60°C		
	Storage Humidity	10 - 90% (without condensation)		
	Display Orientation	Landscape Only		
Mechanical	Weight (kg)	RP654K: 49/61 (without packing/ with packing) RP704K: 58/71 (without packing/ with packing) RP750K: 64/80 (without packing/ with packing) RP860K: 81/108 (without packing/ with packing)		
		Dimensions (W x H x D) (mm)	RP654K: 1521*967*128/ 1720*280*1113 (without packing/ with packing) RP704K: 1638*1034*128/ 1840*280*1160 (without packing/ with packing) RP750K: 1762*1086*130/ 1913*280*1268 (without packing/ with packing) RP860K: 1988*1230*129/ 2211*280*1420 (without packing/ with packing)	
			Bezel Dimension - T/B/ L/R (mm)	34/ 104/ 34/ 34 mm (+/-1.5mm)
			Feature	
Feature	Image setting		YES	
	Source/Volume Control	YES		
	Sharpness enhancement	NO		
	Adaptive Contrast	NO		
	10-bit color processing	YES		
	Customized Classroom Mode	YES		
	Blank screen	YES		



Specifications and functions are subject to change without notice.

Item		RP654K / RP704K / RP750K / RP860K
System	CPU	A53 dual core / 1.2GHz
	System Memory	2GB
	Storage	16 GB
	OS	Android 5.1.1



This Android 5.1.1 operating system is not standard Android, so access to Google Play™ is not available. APK cannot be installed in the default location unless given permission by the management units. Contact your BenQ dealer for the required support for management permission. Without management permission, installing function won't work. There is no guarantee that the self-installed APK can function normally.

Dimensions (RP654K)

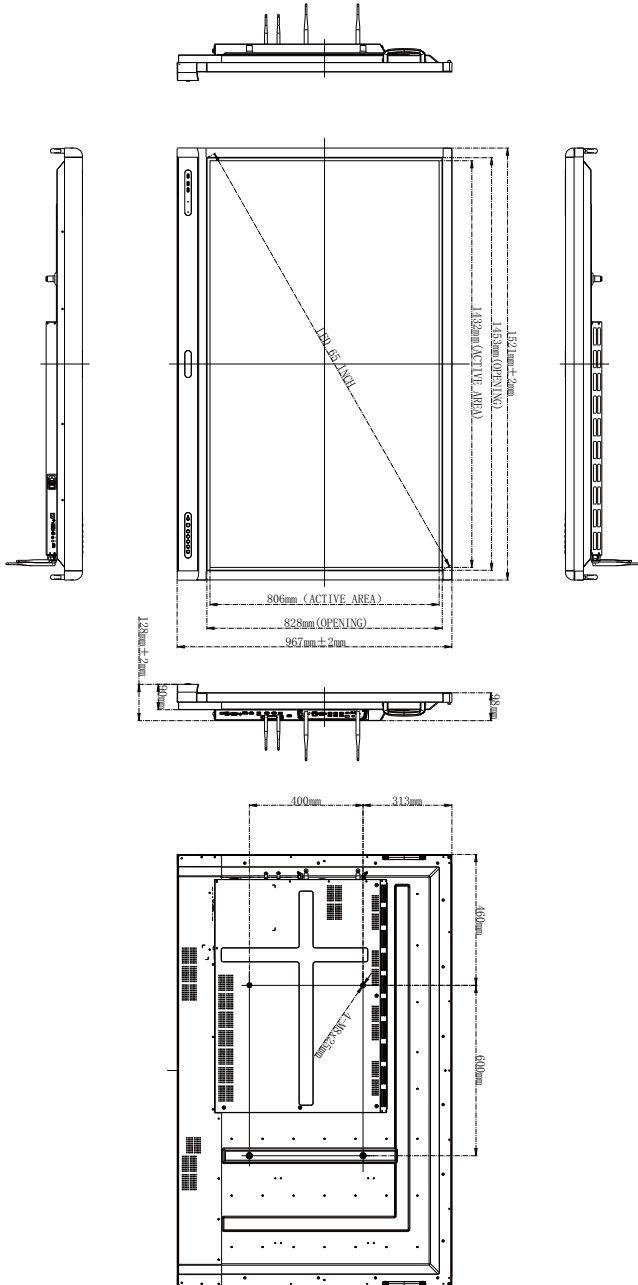

Unit: mm

Dimensions (RP704K)

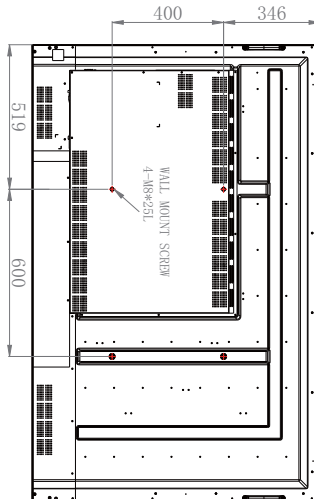
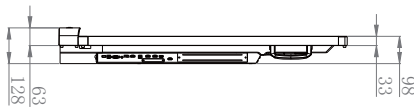
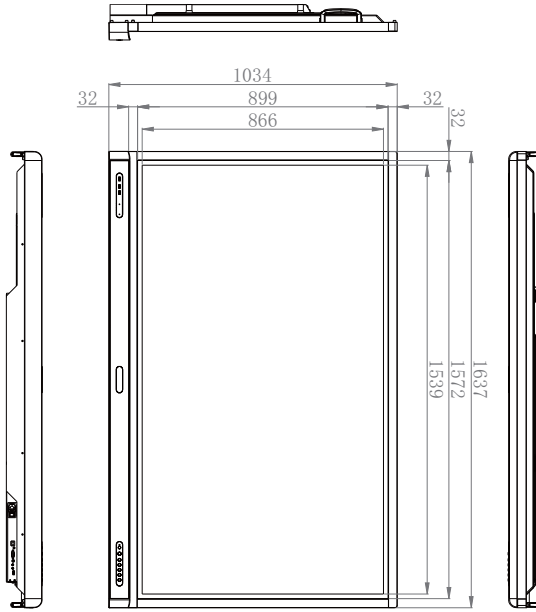

Unit: mm

Dimensions (RP750K)

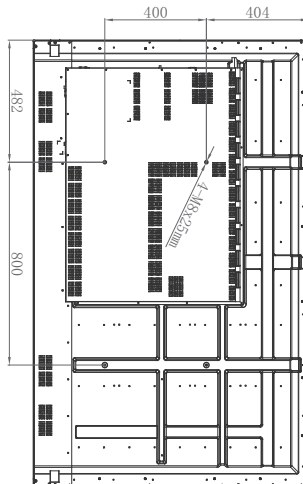
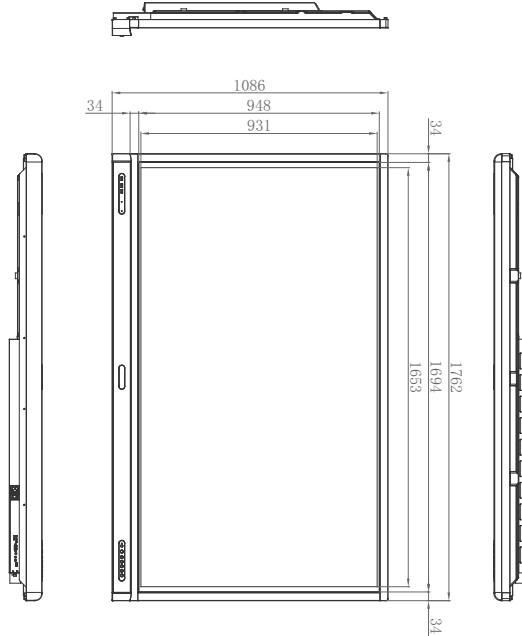

Unit: mm

Dimensions (RP860K)

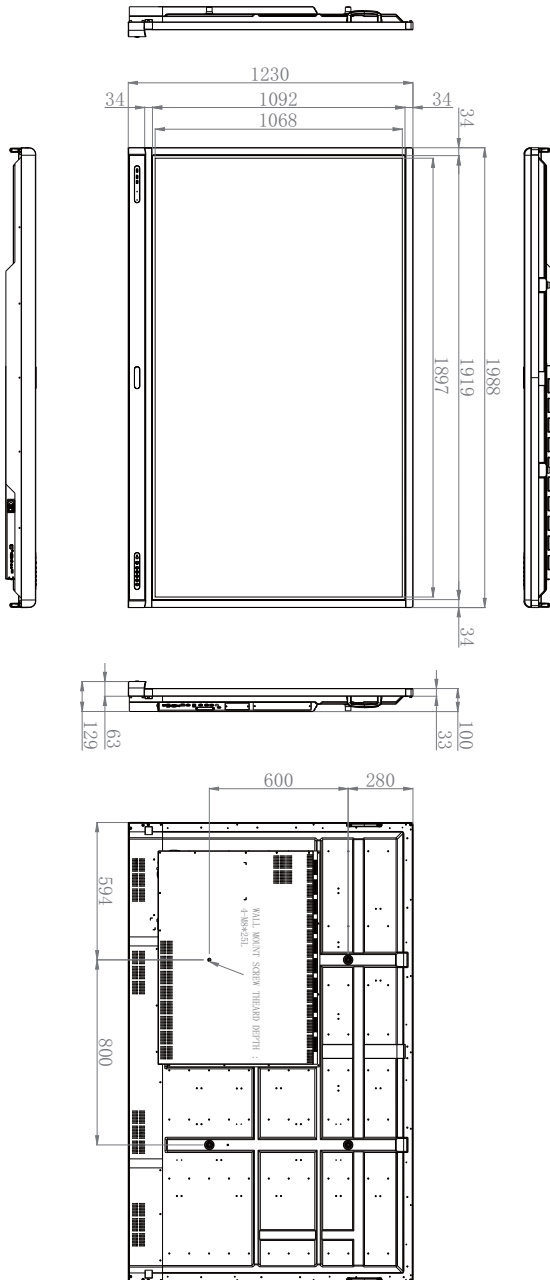

Unit: mm

Supported input signal resolution

Resolution	Input source				
	AV	VGA	Display Port	HDMI 1.4	HDMI 2.0
640 x 480 @ 60Hz		○	○	○	○
640 x 480 @ 67Hz					
640 x 480 @ 72Hz					
640 x 480 @ 75Hz					
720 x 400 @ 70Hz		○	○	○	○
800 x 600 @ 60Hz		○	○	○	○
800 x 600 @ 75Hz					
832 x 624 @ 75Hz					
1024 x 768 @ 60Hz		○	○	○	○
1024 x 768 @ 75Hz					
1152 x 870 @ 75Hz					
1280 x 720 @ 60Hz					
1280 x 768 @ 60Hz		○	○	○	○
1280 x 800 @ 60Hz					
1280 x 800 @ 60Hz					
1280 x 960 @ 60Hz		○	○	○	○
1280 x 1024 @ 60Hz		○	○	○	○
1360 x 768 @ 60Hz					
1366 x 768 @ 60Hz		○	○	○	○
1400 x 1050 @ 60Hz					
1440 x 900 @ 60Hz		○	○	○	○
1600 x 1200 @ 60Hz					
1680 x 1050 @ 60Hz		○	○	○	○
1600 x 1050 @ 60Hz					
1920 x 1080 @ 50Hz					
1920 x 1080 @ 60Hz		○	○	○	○
3840 x 2160 @ 30Hz			○	○	○
3840 x 2160 @ 50Hz					○
3840 x 2160 @ 60Hz					○
NTSC-M	○				
NTSC-J	○				
PAL-BDGHI	○				

480i (60Hz)				○	○
480p (60Hz)				○	○
576i (50Hz)				○	○
576p (50Hz)				○	○
720p (25Hz)					
720p (30Hz)					
720p (50Hz)				○	○
720p (60Hz)				○	○
1080i (50Hz)				○	○
1080i (60Hz)				○	○
1080p (24Hz)					
1080p (25Hz)					
1080p (30Hz)					
1080p (24Psf)					
1080p (25Psf)					
1080p (50Hz)				○	○
1080p (60Hz)				○	○



- ○: supported
- Vacant: not supported

Troubleshooting

Problem	Solution
No picture	<p>Check the following:</p> <ul style="list-style-type: none"> • Is the display turned on? Check the power indicator of the display. • Is the signal source device turned on? Turn on the device and try again. • Are there any loose cable connections? Make sure that all cables are connected firmly. • Have you chosen an unsupported output resolution on the computer? Refer to Supported input signal resolution on page 71 to select a supported resolution and try again. • Have you chosen an unsupported output resolution on the DVD or Blu-ray disc player? Refer to Supported input signal resolution on page 71 to select a supported resolution and try again.
No sound	<p>Check the following:</p> <ul style="list-style-type: none"> • Have you turned on the mute function on the display or the input source device? Turn off the mute function or increase the audio volume level and try again. • Are there any loose cable connections? Make sure that all cables are connected firmly.
The computer input image looks strange	<ul style="list-style-type: none"> • Have you chosen an unsupported output resolution on the computer? Refer to Supported input signal resolution on page 71 to select a supported resolution and try again. • Use the Auto function (VGA only) to let the display automatically optimize the display of computer image. • If the result of the Auto function is not satisfactory, use the Phase, H Position and V Position functions to manually adjust the image.
The control panel buttons do not work	<p>Have you locked the control panel buttons? Unlock the buttons and try again.</p>

The remote control does not work	<ul style="list-style-type: none"> • Have you locked the remote control function? Unlock the function and try again. • Check for incorrect battery orientation. • Check for dead batteries. • Check your distance and angle from the display. • Check whether remote control is properly being pointed at the display's remote control sensor window. • Check for any obstacle between the remote control and the remote control sensor window. • Check that the remote control sensor window is not under strong fluorescent lighting, or in direct sunlight. • Check for any devices (computer or personal digital assistant, PDA) nearby that transmit infrared signals which may cause interference to signal transmission between the remote control and the display. Turn off the infrared function of these devices.
Remote control failure	<ul style="list-style-type: none"> • Check whether there are other objects between remote control and television remote control receiving window, thus leading to failure of remote control. • Check whether the battery electrode in the remote control is correct. • Check whether remote control needs to replace battery.
Machine automatically shutdown	<ul style="list-style-type: none"> • Whether set sleep or not. • Check whether there is sudden power outage. • Check whether there is no signal automatic shutdown.
Signal out of range	<ul style="list-style-type: none"> • Check whether display is set correctly. • Check whether resolution is the best resolution. • Adjust line and field synchronization in menu.
Background has vertical lines or streaks	<ul style="list-style-type: none"> • Select automatic correction in menu. • Adjust clock and phase position in menu.
Image lack of color, color is incorrect	<ul style="list-style-type: none"> • Check whether VGA is not well connected or has quality problem. • Adjust chromaticity and brightness or contrast in menu.
Display format that is not supported.	<ul style="list-style-type: none"> • Select automatic correction in menu. • Adjust clock and phase position in menu.
Touch function invalid	<ul style="list-style-type: none"> • Check whether touch driver is installed and started. • Check whether the size of article touched is comparable with finger.
Touch positioning not correct	<ul style="list-style-type: none"> • Check whether driver is properly installed and make correction. • Check whether touch pen is facing the screen.

No picture and no sound	<ul style="list-style-type: none"> • Check whether the machine is started state. • Check whether signal wire is well plugged, whether INPUT is corresponding to it. • If in internal computer mode, check whether internal computer is started.
With horizontal or vertical stripes or image dithering	<ul style="list-style-type: none"> • Check whether signal wire is well connected. • Check whether other electronic equipment or power tools are placed around the machine.
No color, color is weak or image is weak	<ul style="list-style-type: none"> • Adjust chromaticity and brightness or contrast in menu. • Check whether signal wire is well connected.
With image but without sound	<ul style="list-style-type: none"> • Check whether mute button is pressed for mute. • Press VOL+/VOL- to adjust volume. • Check whether audio line is connected correctly.
Only one speaker has sound	<ul style="list-style-type: none"> • Adjust sound balance in menu. • Check whether computer sound control panel only sets up one sound channel. • Check whether audio line is connected correctly.
VGA output without sound	Check whether connect external device with headphone cable.