

Touchboards

205 Westwood Ave, Long Branch, NJ 07740
Phone: 866-94 BOARDS (26273) / (732)-222-1511
Fax: (732)-222-7088 | E-mail: sales@touchboards.com

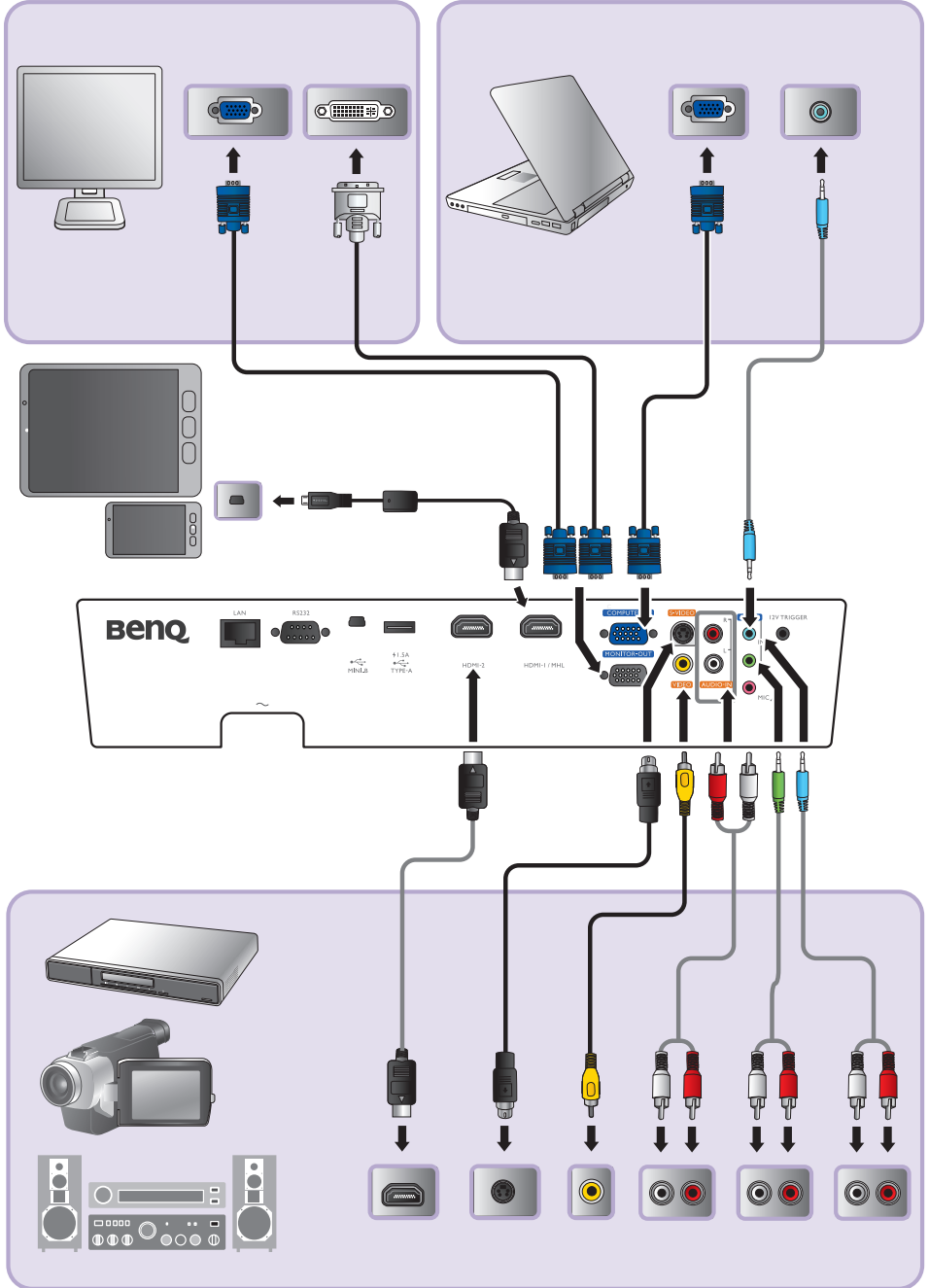

Projection dimensions

■ The screen aspect ratio is 16:10 and the projected picture is 16:10

<F>: Screen

<G>: Center of lens

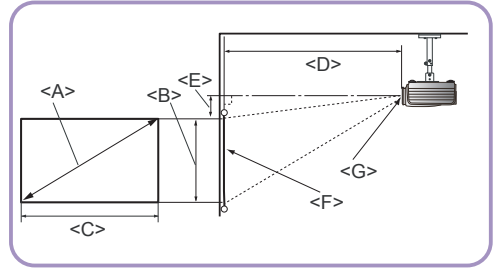
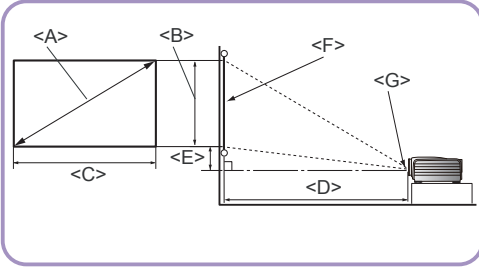

SU922

Screen dimensions			Projection distance <D> [cm]			Lowest/ Highest lens position <E> [cm]
Diagonal <A> [inch (mm)]	Height [cm]	Width <C> [cm]	Min distance	Average	Max distance	
60 (1524)	81	129	139	180	221	4.0
70 (1778)	94	151	162	210	258	4.7
80 (2032)	108	172	185	240	295	5.4
90 (2286)	121	194	208	270	332	6.1
100 (2540)	135	215	231	300	369	6.7
110 (2794)	148	237	254	330	406	7.4
120 (3048)	161	259	277	360	442	8.1
130 (3302)	175	280	300	390	479	8.8
140 (3556)	189	302	323	420	516	9.4
150 (3810)	202	323	346	450	553	10.1
160 (4064)	215	345	369	479	590	10.8
170 (4318)	229	366	392	509	627	11.4
180 (4572)	242	388	415	539	663	12.1
190 (4826)	256	409	438	569	700	12.8
200 (5080)	269	431	461	599	737	13.5
240 (6096)	323	517	554	719	884	16.2



The above numbers are approximate and may be slightly different from the actual measurements. Only the recommended screen sizes are listed. If your screen size is not in the table above, please contact your dealer for assistance.

Projection dimensions

■ The screen aspect ratio is 16:10 and the projected picture is 16:10

<F>: Screen

<G>: Center of lens

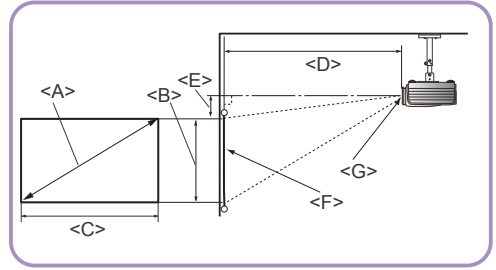
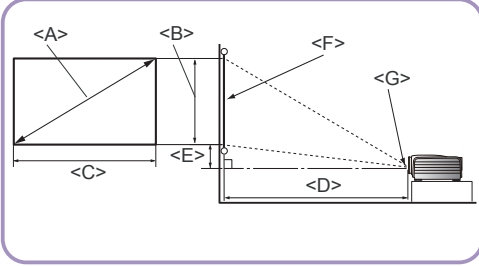

SW921

Screen dimensions			Projection distance <D> [cm]			Lowest/ Highest lens position <E> [cm]
Diagonal <A> [inch (mm)]	Height [cm]	Width <C> [cm]	Min distance	Average	Max distance	
60 (1524)	81	129	145	189	233	6.1
70 (1778)	94	151	169	221	272	7.1
80 (2032)	108	172	193	252	311	8.1
90 (2286)	121	194	218	283	349	9.1
100 (2540)	135	215	242	315	388	10.1
110 (2794)	148	237	266	346	427	11.1
120 (3048)	162	259	290	378	466	12.1
130 (3302)	175	279	314	409	504	13.1
140 (3556)	189	302	338	441	543	14.1
150 (3810)	202	323	362	472	582	15.1
160 (4064)	215	345	386	504	621	16.2
170 (4318)	229	366	411	535	660	17.2
180 (4572)	242	388	435	566	698	18.2
190 (4826)	256	409	459	598	737	19.2
200 (5080)	269	431	483	629	776	20.2
240 (6096)	323	517	579	755	931	24.2



The above numbers are approximate and may be slightly different from the actual measurements. Only the recommended screen sizes are listed. If your screen size is not in the table above, please contact your dealer for assistance.

Projection dimensions

■ The screen aspect ratio is 4:3 and the projected picture is 4:3

<F>: Screen

<G>: Center of lens

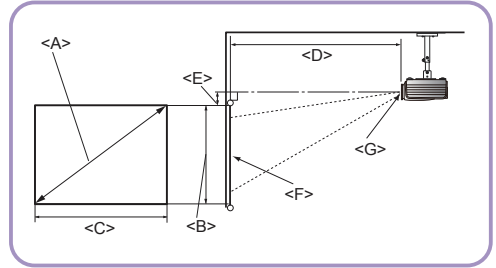
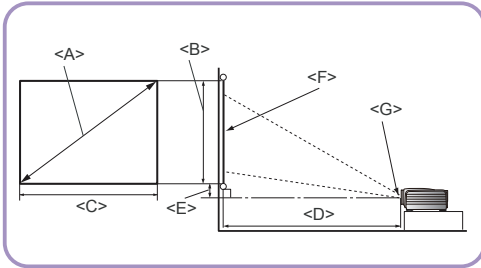

SX920

Screen dimensions			Projection distance <D> [cm]			Lowest/ Highest lens position <E> [cm]
Diagonal <A> [inch (mm)]	Height [cm]	Width <C> [cm]	Min distance	Average	Max distance	
60 (1524)	91	122	172	224	275	13.7
70 (1778)	107	142	201	261	320	16.0
80 (2032)	122	163	230	298	366	18.3
90 (2286)	137	183	258	335	412	20.6
100 (2540)	152	203	287	372	458	22.9
110 (2794)	168	224	316	409	503	25.1
120 (3048)	183	244	344	447	549	27.4
130 (3302)	198	264	373	484	595	29.7
140 (3556)	213	285	402	521	641	32.0
150 (3810)	229	305	430	558	686	34.3
160 (4064)	244	325	459	595	732	36.6
170 (4318)	259	345	488	633	778	38.9
180 (4572)	274	366	516	670	823	41.1
190 (4826)	290	386	545	707	869	43.4
200 (5080)	305	406	573	744	915	45.7
240 (6096)	366	488	688	893	1098	54.9



The above numbers are approximate and may be slightly different from the actual measurements. Only the recommended screen sizes are listed. If your screen size is not in the table above, please contact your dealer for assistance.

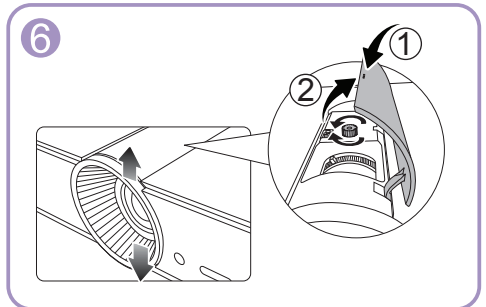
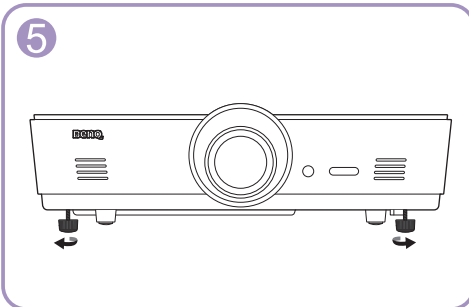
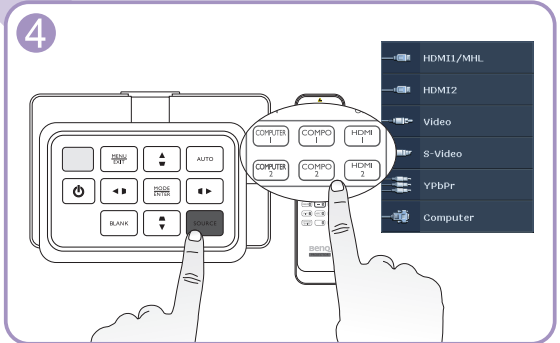
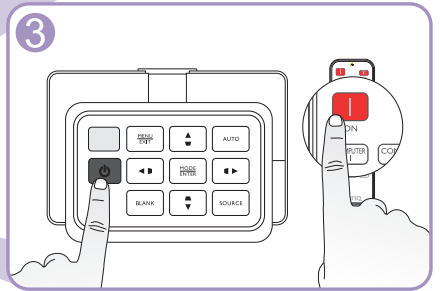
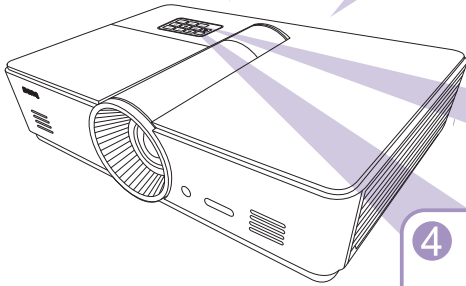
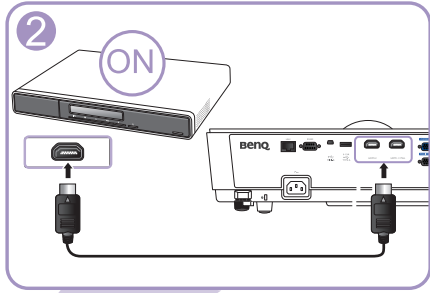
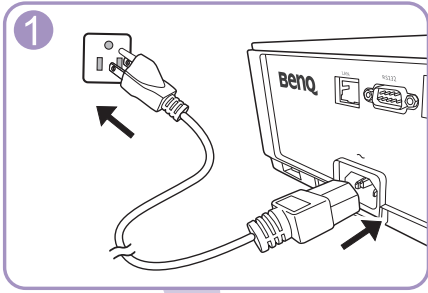

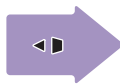
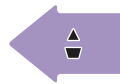
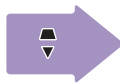
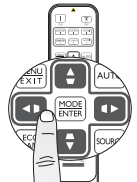
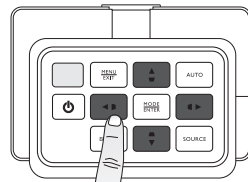
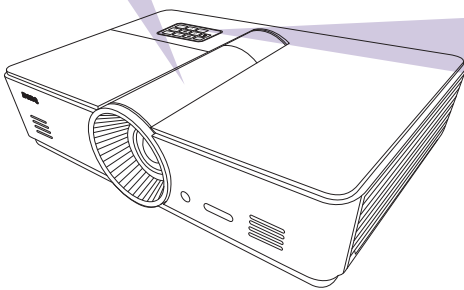
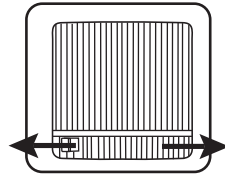
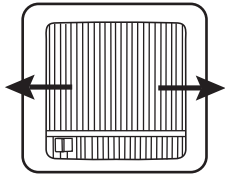

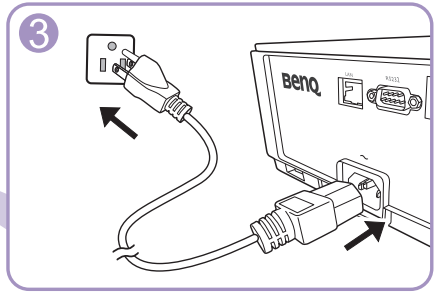
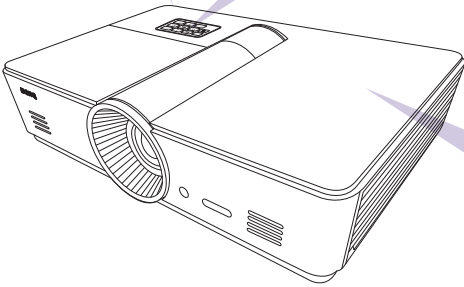
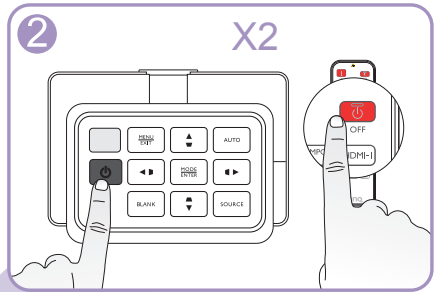
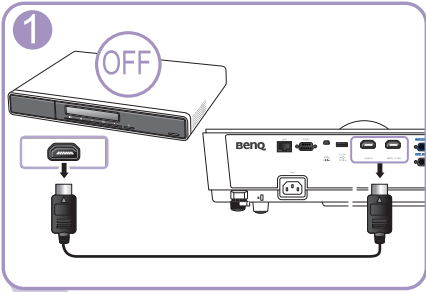

Ceiling mount screws: M5
(Max. L = 25 mm;
Min. L = 20 mm)
Unit: mm

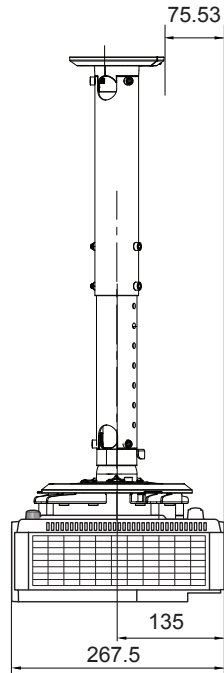
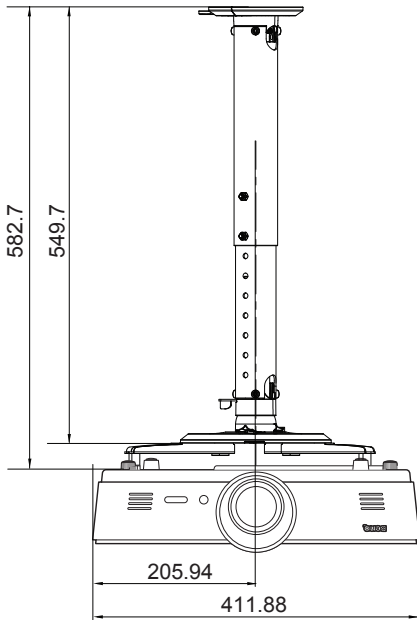
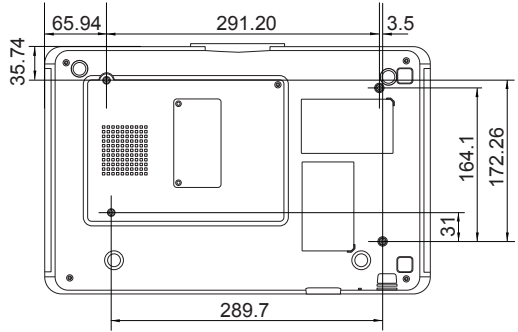
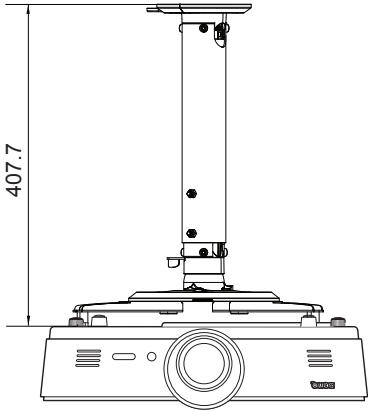

Table of contents

English	11
Français	12
Deutsch	13
Italiano	14
Español	15
Português	16
Svenska	17
Русский	18
Nederlands	19
Polski	20
Türkçe	21
Čeština	22
ไทย	23
繁體中文	24
简体中文	25
日本語	26
한국어	27
العربية	28

Specifications

(EN)

 All specifications are subject to change without notice.

■ Optical

Projection system	Single-chip DLP™ system
Native resolution	SX920: 0.55" DLP (1024 x 768); SW921: 0.65" DLP (1280 x 800); SU922: 0.67" DLP (1920 x 1200)
Lens	F = 2.45 to 3.07, f = 15.78 to 25.12 mm
Projection screen size	60" to 240"
Lamp	370W

■ Electrical

Compatibility	PC: SX920/SW921: 640 x 480 to 1600 x 1200; SU922: 640 x 480 to 1920 x 1200
Color Space	Video: NTSC, PAL, SECAM, YPbPr (480i/480p/576i/576p/720p/1080i/1080p), HDTV (720p/1080i/1080p) Typ. = 60% NTSC

■ Terminals

Input	Analog RGB: D-Sub 15-pin (female) x 1 HDMI (V. 1.4a) x 2 MHL (V 2.1) x 1 (shared with HDMI input) S-Video: Mini DIN 4pin x 1 Component Video (Y/CB/CR, Y/PB/PR) x 1 (shared with RGB input) Composite Video x 1 RCA Audio x 1 PC Audio x 1 Microphone x 1 RJ45 LAN x 1
Output	Analog RGB: D-Sub 15-pin (female) x 1 Audio out x 1 Speaker: 10W x 2
Control	Serial Connector: RS232 9 pin (male) USB: Type-A USB x 1; Mini B type USB x 1 IR receiver x 2 LAN x 1 (RJ45) 12V DC Trigger x 1 (Max. 0.5 A)

■ General characteristics

Projector weight	4.9 kg (10.80 lbs)
Power	VAC 100-240V, 6 A, 50-60Hz
Power consumption	Max. 594 W; Standby < 0.5 W; Network Standby < 3 W
Operating temperature	0 °C to 40 °C (without condensation)
Operating humidity	10% - 90% (without condensation)

(FR)

Caractéristiques

Toutes les caractéristiques peuvent être modifiées sans notification préalable.

■ Caractéristiques optiques

Système de projection

Système à une puce DLP™

Puce DMD

SX920: DLP 0,55" (1024 x 768); SW921: DLP 0,65" (1280 x 800); SU922: DLP 0,67" (1920 x 1200)

Objectif

F = 2,45 à 3,07, f = 15,78 à 25,12 mm

Taille de l'écran de projection

60" à 240" (152 cm à 610 cm)

Lampe

370W

■ Caractéristiques électriques

Compatibilité

PC : SX920/SW921: 640 x 480 à 1600 x 1200;
SU922: 640 x 480 à 1920 x 1200

Espace couleur

Vidéo : NTSC, PAL, SECAM, YPbPr (480i/480p/576i/576p/720p/1080i/1080p), HDTV (720p/1080i/1080p)
Typ. = 60% NTSC

■ Prises

Entrée

RVB analogique : D-Sub 15 broches (femelle) x 1

HDMI (V. 1,4a) x 2

MHL (V. 2,1) x 1 (partagé avec l'entrée HDMI)

S-Video : mini DIN à 4 broches x 1

Vidéo composantes (Y/ CB/CR, Y/PB/PR) x 1 (partagé avec entrée RVB)

Vidéo composite x 1

Entrée audio RCA x 1

Entrée audio PC x 1

Microphone x 1

Réseau RJ45 x 1

Sortie

RVB analogique : D-Sub 15 broches (femelle) x 1

Prise sortie audio

Haut-parleur : 10 W x 2

Commande

Connecteur série : RS232 à 9 broches (mâle)

USB: USB type mini B x 1; USB type A x 1

Récepteur IR x 2

Réseau x 1 (RJ45)

Déclencheur 12 V CC x 1 (max. 0,5 A)

■ Caractéristiques générales

Poids du projecteur

4,9 kg (10,80 lb)

Alim.

100 à 240 V AC, 6 A, 50/60 Hz

Consommation

Max. 594 W ; veille < 0,5 W ; veille réseau < 3 W

Température de fonctionnement

0°C à 40°C (sans condensation)

Humidité en fonctionnement

10% à 90% (sans condensation)

Technische Daten



Alle Daten können ohne Bekanntmachung geändert werden.

■ Optische Daten

Projektionssystem

DMD-Chip

Objektivlinse

Größe des Projektionsbilds

Lampe

Einzel-Chip DLP™-System

SX920: 0,55" DLP (1024 x 768); SW921: 0,65" DLP (1280 x 800); SU922: 0,67" DLP (1920 x 1200)

F = 2,45 bis 3,07; f = 15,78 bis 25,12 mm

60" bis 240"

370W

■ Elektrische Daten

Kompatibilität

PC: SX920/SW921: 640 x 480 bis 1600 x 1200;

SU922: 640 x 480 bis 1920 x 1200

Video: NTSC, PAL, SECAM, YPbPr (480i/480p/576i/576p/720p/1080i/1080p), HDTV (720p/1080i/1080p)

Typ. = 60% NTSC

Farbraum

■ Anschlüsse

Eingang

Analog RGB: Eine 15-polige D-Sub-Buchse

HDMI (V. 1.4a) x 2

MHL (V. 2.1) x 1 (geteilt mit HDMI Eingang)

S-Video: Mini DIN 4-polige x 1

Component-Video (Y/ CB/CR, Y/PB/PR) x 1 (gemeinsam benutzt mit RGB-Eingang)

Composite-Video x 1

Cinch Audioeingang x 1

PC Audioeingang x 1

Mikrofon x 1

RJ45 LAN x 1

Analog RGB: D-Sub 15-Pin (weiblich) x 1

Audioausgang x 1

Lautsprecher: 10W x 2

Serieller Anschluss: 9-poliger RS232 (Stecker)

USB: USB (Typ-A) x 1 ; USB (Mini B Typ) x 1

IR-Empfänger x 2

LAN x 1 (RJ45)

12V DC Auslöser x 1 (Max. 0,5 A)

Ausgang

Steuerung

■ Allgemeine Eigenschaften

Gewicht des Projektors

4,9 kg (10,80 lbs)

Stromversorgung

VAC 100-240V, 6 A, 50-60Hz

Stromverbrauch

Max. 594 W; Standby < 0,5 W; Netzwerk Standby < 3 W

Betriebstemperatur

0°C bis 40°C (nicht kondensierend)

Betriebsluftfeuchtigkeit

10% bis -90% (nicht kondensierend)



Specifiche tecniche

Tutte le specifiche sono soggette a modifiche senza preavviso.

■ Parte ottica

Sistema di proiezione
Chip DMD

Sistema DLP™ a chip singolo
SX920: DLP da 0,55" (1024 x 768); **SW921:** DLP da 0,65" (1280 x 800); **SU922:** DLP da 0,67" (1920 x 1200)
 F = da 2,45 a 3,07, f = da 15,78 a 25,12 mm
 Da 60" a 240"

Obiettivo
Dimensioni schermo di proiezione
Lampada

370W

■ Parte elettrica

Compatibilità

PC: **SX920/SW921:** 640 x 480 a 1600 x 1200;
SU922: 640 x 480 a 1920 x 1200

Video: NTSC, PAL, SECAM, YPbPr (480i/480p/576i/576p/720p/1080i/1080p), HDTV (720p/1080i/1080p)
 Typ. = 60% NTSC

Spazio di colore

■ Terminali

Input

RGB analogico: D-Sub da 15-pin (femmina) x 1
 HDMI (V. 1.4a) x 2
 MHL (V. 2.1) x 1 (condiviso con l'ingresso HDMI)
 S-Video: Mini DIN 4pin x 1
 Component Video (Y/ CB/CR, Y/PB/PR) x 1 (in condivisione con input RGB)
 Composite Video x 1
 Ingresso audio RCA x 1
 Ingresso audio PC x 1
 Microfono x 1
 RJ45 LAN x 1

Uscita

RGB analogico: D-Sub da 15-pin (femmina) x 1
 Audio out x 1

Controllo

Altoparlante 10W x 2
 Connettore seriale: RS232 a 9 pin (maschio)
 USB: USB (tipo A) x 1; USB (Mini tipo B) x 1
 Ricevitore infrarossi x 2
 LAN x 1 (RJ45)
 Interruttore 12 V CC x 1 (massimo 0,5 A)

■ Caratteristiche generali

Peso del proiettore

4,9 kg (10,80 lbs)

Power

VAC 100-240V, 6 A, 50-60Hz

Consumo energetico

Max. 594 W; Standby < 0,5 W; Standby rete < 3 W

Temperatura operativa

da 0°C a 40°C (senza condensa)

Umidità operativa

da 10% a 90% (senza condensa)

Especificaciones

(ES)

Todas las especificaciones están sujetas a cambio sin previo aviso.

■ Óptico

Sistema de proyección
Chip DMD

Sistema DLP™ de un solo chip
SX920: DLP 0,55 pulg. (1024 x 768);
SW921: DLP 0,65 pulg. (1280 x 800);
SU922: DLP 0,67 pulg. (1920 x 1200)
 F = 2,45 a 3,07; f = 15,78 a 25,12 mm
 60 pulg. a 240 pulg.

Lente

Tamaño de la pantalla de proyección

Lámpara

370W

■ Especificaciones eléctricas

Compatibilidad

PC: SX920/SW921: 640 x 480 a 1600 x 1200;
 SU922: 640 x 480 a 1920 x 1200

Vídeo: NTSC, PAL, SECAM, YPbPr (480i/480p/
 576i/576p/720p/1080i/1080p), HDTV (720p/1080i/
 1080p)

Tip. = 60% NTSC

Espacio de color

■ Terminales

Entrada

RGB analógico: D-Sub de 15 patillas (hembra) x 1
HDMI (V. 1.4a) x 2

MHL (V. 2.1) x 1 (compartido con entrada HDMI)

S-Vídeo: Mini DIN de 4 patillas x 1

Componente de vídeo (Y/ CB/CR, Y/PB/PR) x 1
 (compartido con entrada RGB)

Vídeo compuesto x 1

Entrada de audio RCA x 1; **Entrada de audio de PC**
 x 1; **Micrófono** x 1

RJ45 LAN x 1

RGB analógico: D-Sub de 15 patillas (hembra) x 1

Salida de audio x 1

Altavoz: 10W x 2

Conector en serie: RS232 de 9 patillas(macho)

USB: USB (Tipo-A) x 1; USB (Tipo mini B) x 1

Receptor IR x 2

LAN x 1 (RJ45)

Disparador de 12 V CC x 1 (máx. 0,5 A)

Salida

Control

■ Características generales

Peso del proyector

4,9 kg (10,80 lbs)

Alimentación

100 -240 V de CA; 6 A, 50-60 Hz

Consumo de energía

Máx. 594 W; en espera < 0,5 W; Espera red < 3 W

Temperatura de funcionamiento

0°C a 40°C (sin condensación)

Humedad de funcionamiento

10% - 90% (sin condensación)

(PT)

Especificações

 Todas as especificações estão sujeitas a alteração sem aviso prévio.

■ Ópticas

Sistema de projecção

Sistema Single-chip DLP™

Chip DMD

SX920: 0,55" DLP (1024 x 768); SW921: 0,65" DLP (1280 x 800); SU922: 0,67" DLP (1920 x 1200)

Lente

F = 2,45 a 3,07, f = 15,78 a 25,12 mm

Tamanho de ecrã de projecção

60" a 240"

Lâmpada

370 W

■ Eléctricas

Compatibilidade

Computador: SX920/SW921: 640 x 480 a 1600 x 1200; SU922: 640 x 480 a 1920 x 1200

Video: NTSC, PAL, SECAM, YPbPr (480i/480p/576i/576p/720p/1080i/1080p), HDTV (720p/1080i/1080p)

Tip. = 60% NTSC

Espaço de Cor

■ Terminais

Entrada

RGB Analógico: D-sub 15 pinos (fêmea) x 1

HDMI (V. 1.4a) x 2

MHL (V. 2.1) x 1 (partilhado com entrada HDMI)

S-Video: Mini DIN 4 pinos x 1

Video Componente (Y/ CB/CR, Y/PB/PR) x 1 (partilhado com entrada RGB)

Entrada áudio RCA x 1

Entrada áudio PC x 1

Microfone x 1

RJ45 LAN x 1

Saída

RGB Analógico: D-sub 15 pinos (fêmea) x 1

Saída Áudio x 1

Altifalante: 10 W x 2

Controlo

Conector de Série: RS232 9 pinos (macho)

USB: USB (Tipo A) x 1 ; USB (Tipo Mini B) x 1

Receptor IR x 2

LAN x 1 (RJ45)

Interruptor 12 V DC x 1 (Máx. 0,5 A)

■ Características gerais

Peso do projector

4,9 kg (10,80 lbs)

Energia

VAC 100-240V, 6 A, 50-60Hz

Consumo de energia

Máx. 594 W; Em espera < 0,5 W; Suspensão em rede < 3 W

Temperatura de funcionamento

0°C a 40°C (sem condensação)

Humidade de funcionamento

10% - 90% (sem condensação)

Specifikationer



Alla specifikationer kan ändras utan föregående meddelande.

■ Optik

Projektorssystem
DMD-krets

DLP™-system med enkel krets
SX920: 0,55" DLP (1024 x 468); SW921: 0,65" DLP (1280 x 800); SU922: 0,67" DLP (1920 x 1200)

Lins

F=2,45 till 3,07, f= 15,78 till 25,12 mm

Skärmstorlek

60" till 240"

Lampa

370W

■ EI

Kompatibilitet

PC: SX920/SW921: 640 x 480 till 1600 x 1200;
SU922: 640 x 480 till 1920 x 1200

Video: NTSC, PAL, SECAM, YPbPr (480i/480p/576i/576p/
720p/1080i/1080p), HDTV (720p/1080i/1080p)

Typ. = 60% NTSC

Färgområde

■ Kontakter

Ingångar

Analog RGB: D-Sub (hona) med 15 stift x 1

HDMI (V. 1.4a) x 2

MHL (V. 2.1) x 1 (delar ingång med HDMI)

S-Video: Mini DIN 4-stift x 1

Komponentvideo (Y/CB/CR, Y/PB/PR) x 1 (delad med RGB)

Kompositvideo x 1

RCA-ljudingång x 1

PC-ljudingång x 1

Mikrofon x 1

RJ45 LAN x 1

Analog RGB: D-Sub (hona) med 15 stift x 1

Ljudutgång x 1

Högtalare: 10W x 2

Serieanslutning: RS232 9-stifts (hane)

USB: USB (Typ A) x 1 ; USB (Typ Mini B) x 1

IR-mottagare x 2

LAN x 1 (RJ45)

12 V DC-utlösare x 1 (Max. 0,5 A)

Uttag

Kontroll

■ Allmänna egenskaper

Projektorns vikt

4,9 kg (10,80 lbs)

Av/på

VAC 100-240V, 6 A, 50-60Hz

Strömförbrukning

Max. 594 W; Viloläge < 0,5 W; Nätverksviloläge < 3 W

Driftstemperatur

0°C till 40°C (icke-kondenserande)

Driftsfuktighet

10 - 90 % (icke-kondenserande)

(RU) Технические характеристики

☞ Все характеристики могут быть изменены без предварительного уведомления.

■ Оптические характеристики

Система проектирования	Система Single-chip DLP™
DMD чип	SX920: 0.55" DLP (1024 x 768); SW921: 0.65" DLP (1280 x 800); SU922: 0.67" DLP (1920 x 1200)
Объектив	F = 2.45 - 3.07, f = 15.78 - 25.12 мм
Размер экрана проецирования	60" - 240"
Лампа	370 Вт

■ Электрические характеристики

Совместимость	ПК: SX920/SW921: 640 x 480 - 1600 x 1200; SU922: 640 x 480 - 1920 x 1200 Видео: NTSC, PAL, SECAM, YPbPr (480i/480p/576i/576p/720p/1080i/1080p), HDTV (720p/1080i/1080p) Тип. = 60% NTSC
Цветовое пространство	Тип. = 60% NTSC

■ Терминалы

Вход	Аналоговый RGB 15-контактный D-sub (гнездо) x 1 HDMI (V. 1.4a) x 2 MHL (V. 2.1) x 1 (совместно со входом HDMI) S-Video: 4-контактный разъем Mini DIN x 1 Компонентное видео (Y/CB/CR, Y/PB/PR) x 1 (вместе с RGB входом) Композитное видеосигнал x 1 Аудиовход RCA x 1 Аудиовход ПК x 1 Микрофон x 1 RJ45 LAN x 1
Выход	Аналоговый RGB 15-контактный D-sub (гнездо) x 1 Аудиовыход x 1 Динамик: 10 Вт x 2
Управление	Последовательный разъем: RS232 9 контактный (штырьковый) USB: USB (тип A) x 1 ; USB (тип Mini B) x 1 ИК-приемник x 2 LAN x 1 (RJ45) Переключатель 12 В x 1 (макс. 0,5 А)

■ Общие характеристики

Вес проектора	4,9 кг (10,80 фунта)
Питание	В перем. тока 100-240В, 6 А, 50-60Гц
Энергопотребление	Макс. 594 Вт; Режим ожидания < 0,5 Вт; режим ожидания сети < 3 Вт
Рабочая температура	0 °C ~ 40 °C (без конденсации)
Рабочая влажность	10% ~ 90% (без конденсации)

Specificaties



Alle specificaties kunnen zonder voorafgaande kennisgeving worden gewijzigd.

■ Optisch

Projectiesysteem
DMD chip

Single-chip DLP™-systeem

SX920: 0,55" DLP (1024 x 768); SW921: 0,65" DLP (1280 x 800); SU922: 0,67" DLP (1920 x 1200)

Lens

F = 2,45 tot 3,07, f = 15,78 tot 25,12 mm

Geprojecteerde schermgrootte

60" tot 240"

Lamp

370W

■ Electrisch

Compatibiliteit

**PC: SX920/SW921: 640 x 480 tot 1600 x 1200;
SU922: 640 x 480 tot 1920 x 1200**

Video: NTSC, PAL, SECAM, YPbPr (480i/480p/576i/576p/720p/1080i/1080p), HDTV (720p/1080i/1080p)

Typ. = 60% NTSC

Kleurruimte

■ Aansluitingen

Ingangen

Analoog RGB: D-sub 15-pin (contrastekker) x 1

HDMI (V. 1.4a) x 2

MHL (V. 2.1) x 1 (gedeeld met HDMI-ingang)

S-Video: Mini DIN 4-pin x 1

Component video (Y/CB/CR, Y/PB/PR) x 1 (gedeeld met RGB-ingang)

Composite video x 1

Audio: RCA Audio-in x 1; PC Audio-in x 1

Microfoon x 1

RJ45 LAN x 1

Analoog RGB: D-sub 15-pin (contrastekker) x 1

Audio uit x 1

Luidspreker: 10W x 2

Seriële aansluiting: RS232 9-pin (male)

Usb: Usb (Type-A) x 1 ; Usb (mini B-type) x 1

IR-ontvanger x 2

LAN x 1 (RJ45)

12 V gelijkspanningstrigger x 1 (max. 0,5 A)

Uitgang

Bediening

■ Algemene kenmerken

Projectorgewicht

4,9 kg (10,80 lbs)

Energie

VAC 100-240V, 6 A, 50-60Hz

Stroomverbruik

Max. 594; stand-by < 0,5 W; netwerkstand-by < 3 W

Bedrijfstemperatuur

0°C tot 40°C (zonder condens)

Omgevingsvochtigheid

10% - 90% (zonder condens)

(PL)

Dane techniczne

 Wszystkie specyfikacje mogą ulec zmianie bez powiadomienia.

■ Parametry optyczne

System projekcji

System pojedynczego chipa DLP™

Chip DMD

SX920: 0,55" DLP (1024 x 768); SW921: 0,65" DLP (1280 x 800); SU922: 0,67" DLP (1920 x 1200)

Obiektyw

F = 2,45 do 3,07, f = 15,78 do 25,12 mm

Rozmiar ekranu projekcyjnego

60" do 240"

Lampa

370 W

■ Parametry elektryczne

Kompatybilność

PC: SX920/SW921: Od 640 x 480 do 1600 x 1200;
SU922: Od 640 x 480 do 1920 x 1200

Video: NTSC, PAL, SECAM, YPbPr (480i/480p/576i/576p/720p/1080i/1080p), HDTV (720p/1080i/1080p)

Typ. = 60% NTSC

Przestrzeń kolorów

■ Złącza

Wejście

Analogowe RGB: D-Sub 15-szpilekowe (żeńskie) x 1

HDMI (V. 1,4a) x 2

MHL (wer. 2.1) x 1 (wspólnie z wejściem HDMI)

S-Video: 4-stykowe złącze Mini DIN x 1

Video komponentowe (Y/CB/CR, Y/PB/PR) x 1
(dzielone z wejściem RGB)

Video kompozytowe x 1

Wejście audio RCA x 1

Wejście audio PC x 1

Mikrofon x 1

RJ45 LAN x 1

Wyjście

Analogowe RGB: D-Sub 15-szpilekowe (żeńskie) x 1

Wyjście audio x 1

Głośnik: 10 W x 2

Sterowanie

Port szeregowy: RS232 9-szpilekowe (męskie)

USB: USB (typu A) x 1; USB (typu mini B) x 1

Odbiornik podczerwieni x 2

LAN x 1 (RJ45)

Przełącznik 12V DC x 1 (maks. 0,5 A)

■ Ogólna charakterystyka

Waga projektora

4.9 kg (10,80 funta)

Zasilanie

Prąd zmienny 100-240V, 6 A, 50-60Hz

Zużycie energii

Maks. 594 W; Tryb gotowości < 0,5 W;

Tryb gotowości sieciowej < 3 W

Temperatura pracy

0°C - 40°C (bez kondensacji)

Wilgotność pracy

10% ~ 90% (bez kondensacji)

Spesifikasyonlar

(TR)

Tüm spesifikasyonlar, haber verilmeden değiştirilebilir.

■ Optik

Yansıtma sistemi

Tek çipli DLP™ sistemi

DMD çipi

SX920: 0,55" DLP (1024 x 768); SW921: 0,65" DLP (1280 x 800); SU922: 0,67" DLP (1920 x 1200)

Lens

F = 2,45 ila 3,07, f = 15,78 ila 25,12 mm

Yansıtma ekranının boyutu

60" - 240"

Lamba

370 W

■ Elektriksel

Uyumluluk

PC: SX920/SW921: 640 x 480 - 1600 x 1200;
SU922: 640 x 480 - 1920 x 1200

Video: NTSC, PAL, SECAM, YPbPr (480i/480p/576i/576p/720p/1080i/1080p), HDTV (720p/1080i/1080p)

Tip = %60 NTSC

Renk Boşluğu

■ Terminaller

Giriş

Analog RGB: D-Sub 15-pin (dişi) x 1

HDMI (V. 1,4a) x 2

MHL (V. 2.1) x 1 (HDMI girişi ile paylaşım)

S-Video: Mini DIN 4pin x 1

Komponent Video (Y/CB/CR, Y/PB/PR) x 1 (RGB girişiyle paylaşılmış)

RCA Ses girişi x 1

PC Ses girişi x 1

Mikrofon x 1

RJ45 LAN x 1

Analog RGB: D-Sub 15-pin (dişi) x 1

Ses çıkışı x 1

Hoparlör: 10 W x 2

Seri Konnektör: RS232 9 pim (erkek)

USB: USB (Tip-A) x 1 ; USB (Mini B tip) x 1

IR alıcısı x 2

LAN x 1 (RJ45)

12VDC Tetik x 1 (Maks. 0,5 A)

Çıkış

Kumanda

■ Genel özellikler

Projektör ağırlığı

4,9 kg (10,80 lb)

Güç

VAC 100-240V, 6 A, 50-60Hz

Güç tüketimi

Maks. 594 W; Bekleme < 0,5 W; Ağ Bekleme < 3 W

İşletim sıcaklığı

0 °C ila 40 °C (yoğuşmasız)

Çalışma nemi

%10 - %90 (yoğuşmasız)

(CZ)

Technické údaje

 Veškeré technické údaje se mohou změnit bez předchozího upozornění.

■ Optické parametry

Projekční systém

Jednočipový systém DLP™

Čip DMD

SX920: 0,55" DLP (1 024 x 768); SW921: 0,65" DLP (1 280 x 1 200); SU922: 0,67" DLP (1 920 x 1 200)

Objektiv

F = 2,45 - 3,07, f = 15,78 - 25,12 mm

Velikost projekčního plátna

60" až 240"

Lampa

370 W

■ Elektrické parametry

Kompatibilita

PC: SX920/SW921: 640 x 480 až 1 600 x 1 200;
SU922: 640 x 480 až 1 920 x 1 200

Video: NTSC, PAL, SECAM, YPbPr (480i/480p/576i/576p/720p/1 080i/1 080p), HDTV (720p/1 080i/1 080p)
Typicky = 60 % NTSC

Barevný prostor

■ Konektory

Vstup

Analogový RGB: D-Sub 15pólový (zásuvkový typ) x 1

HDMI (v. 1.4a) x 2

MHL (V. 2.1) x 1 (sdíleno se vstupem HDMI)

S-Video: Mini DIN 4 piny x 1

Komponentní video (Y/CB/CR, Y/PB/PR) x 1 (sdílený s RGB vstupem)

Kompozitní video x 1

RCA audio vstup x 1

PC audio vstup x 1

Mikrofon x 1

RJ45 LAN x 1

Výstup

Analogový RGB: D-Sub 15pólový (zásuvkový typ) x 1

Audio výstup x 1

Reproduktor: 10 W x 2

Ovládání

Sériový konektor: RS232 9pólový (zástrčkový typ)

USB: USB (Typ A) x 1 ; USB (Typ mini B) x 1

Infračervené čidlo x 2

LAN x 1 (RJ45)

Spínací napětí 12 V DC (stejnosc.) x 1 (max. 0,5 A)

■ Obecné údaje

Hmotnost projektoru

4,9 kg

Napájení

100 - 240 V AC (střídavých), 6 A, 50 - 60 Hz

Příkon

Max. 594 W; pohotovostní režim < 0,5 W;
síťový pohotovostní režim < 3 W

Provozní teplota

0 °C - 40 °C (bez kondenzace)

Provozní vlhkost

10 % - 90 % (bez kondenzace)

รายละเอียดทางด้านเทคนิค



รายละเอียดทางด้านเทคนิคทั้งหมดอาจเปลี่ยนแปลงได้โดยไม่ต้องแจ้งให้ทราบ

■ ระบบออปติค

ระบบการฉายภาพ	ระบบ Single-chip DLP™
ชิป DMD	SX920: 0.55" DLP (1024 X 768); SW921: 0.65" DLP (1280 X 800); SU922: 0.67" DLP (1920 X 1200)
เลนส์	F = 2.45 ถึง 3.07, f = 15.78 ถึง 25.12 มม.
ขนาดจอในการฉายภาพ	60" ถึง 240"
หลอดไฟ	370W

■ ระบบไฟ

ใช้ได้เทียบเท่า	PC: SX920/SW921: 640 X 480 ถึง 1600 X 1200; SU922: 640 X 480 ถึง 1920 X 1200
ที่ว่างสี	วิดีโอ: NTSC, PAL, SECAM, YPbPr (480i/480p/576i/576p/720p/1080i/1080p), HDTV (720p/1080i/1080p) Typ. = 60% NTSC

■ ช่องต่อ

สัญญาณเข้า	RGB อนุาล็อก: D-Sub 15-pin (ปลั๊กตัวเมีย) X 1 HDMI (V. 1.4a) X 2; MHL (V. 2.1) X 1 (ใช้ร่วมกับอินพุต HDMI input) S-Video: Mini DIN 4 ขา X 1 Component Video (Y/Cb/Cr, Y/Pb/Pr) X1 (ใช้ร่วมกับส้าณเข้า RGB) Composite Video X 1 อินพุตระบบเสียง RCA X 1; อินพุตระบบเสียง PC X 1; ไมโครโฟน x 1 RJ45 LAN X 1
เอาต์พุต	RGB อนุาล็อก: D-Sub 15-pin (ปลั๊กตัวเมีย) X 1 Audio out X 1 ลำโพง: 10W X 2
การควบคุม	Serial Connector : RS232 9 pin (ปลั๊กตัวผู้) USB: USB (Type-A) X 1 ; USB (Mini B type) X 1 ตัวรับส้าณอินฟราเรด X 2 LAN X 1 (RJ45) ทริกเกอร์ 12 V DC X 1 (สูงสุด 0.5 A)

■ คุณลักษณะเฉพาะทั่วไป

น้ำหนักโปรเจคเตอร์	4.9 กิโลกรัม (10.80 ปอนด์)
พลังงาน	VAC 100-240V, 6 A, 50-60Hz
การสิ้นเปลืองพลังงาน	สูงสุด 594 W; สแตนด์บาย < 0.5 W; สแตนด์บายเครือข่าย < 3 W
อุณหภูมิการทำงาน	0°C ถึง 40°C (ไม่ก่ลันตัวเป็นหยดน้ำ)
ความชื้นขณะทำงาน	10% - 90% (ไม่ก่ลันตัวเป็นหยดน้ำ)

(TG)

規格

所有規格如有變更，恕不另行通知。

■ 光學

投影系統

單晶片 DLP™ 系統

DMD 晶片

SX920: 0.55" DLP (1024 x 768) ; SW921: 0.65" DLP (1280 x 800) ;
SU922: 0.67" DLP (1920 x 1200)

鏡頭

F = 2.45 至 3.07 · f = 15.78 至 25.12 公釐

投影螢幕尺寸

60" 至 240"

燈泡

370W

■ 電子

相容性

電腦 : SX920/SW921: 640 x 480 至 1600 x 1200;
SU922: 640 x 480 至 1920 x 1200視訊 : NTSC、PAL、SECAM、YPbPr (480i/480p/576i/576p/720p/
1080i/1080p)、HDTV (720p/1080i/1080p)

類型 = 60% NTSC

色彩空間

■ 端子

輸入

類比 RGB : D-Sub 15 針 (母端) x 1

HDMI (V. 1.4a) x 2

MHL (V. 2.1) x 1 (與 HDMI 輸入 共用)

S-Video: Mini DIN 4 針 x 1

色差視訊 (Y/CB/CR、Y/PB/PR) x 1 (與 RGB 輸入 共用)

混合視訊 x 1

RCA 音訊輸入 x 1; PC 音訊輸入 x 1; 麥克風 x 1

RJ45 LAN x 1

輸出

類比 RGB : D-Sub 15 針 (母端) x 1

音訊輸出 x 1

喇叭 : 10W x 2

控制

序列連接頭 : RS232 9 針腳 (公接頭)

USB: Type A 類型 USB x 1; Mini B 類型 USB x 1

紅外線接收器 x 2

LAN x 1 (RJ45)

12 V DC 觸發器 x 1 (最大 0.5 A)

■ 一般特性

投影機重量

4.9 公斤 (10.80 磅)

電源

VAC 100-240V、6 A、50-60Hz

耗電量

最大 594 瓦 ; 待機 < 0.5 瓦 ; 網路待機 < 3 W

操作溫度

0°C - 40°C (無冷凝狀態)

操作濕度

10% - 90% (無冷凝狀態)

规格

(SC)

所有规格如有更改，恕不另行通知。

■ 光学

投影系统
DMD 芯片

单芯片 DLPTM 系统

SX920: 0.55" DLP (1024 x 768) ; SW921: 0.65" DLP (1280 x 800)
; SU922: 0.67" DLP (1920 x 1200)镜头
投影尺寸
灯泡

F = 2.45 至 3.07 , f = 15.78 至 25.12 毫米

60" 至 240"

370W

■ 电气

兼容性

PC : SX920/SW921: 640 x 480 至 1600 x 1200

SU922: 640 x 480 至 1920 x 1200

视频 : NTSC、PAL、SECAM、YPbPr (480i/480p/576i/576p/720p/
1080i/1080p)、HDTV (720p/1080i/1080p)

类型 = 60% NTSC

色彩空间

■ 端子

输入

模拟 RGB : D-sub 15- 针 (母) x 1

HDMI (V. 1.4a) x 2

MHL (V. 2.1) x 1 (与 HDMI 输入共享)

S- 视频 : Mini DIN 4- 针 x 1

分量视频 (Y/CB/CR、Y/PB/PR) x 1 (与 RGB 输入共享)

复合视频 x 1

RCA 音频输入 x 1 ; PC 音频输入 x 1 ; 麦克风 x 1

RJ45 LAN x 1

模拟 RGB : D-sub 15- 针 (母) x 1

音频输出 x 1

扬声器 : 10W x 2

串行接头 : RS232 9 针 (公)

USB: USB (Type-A) x 1 ; USB (Mini B type) x 1

2 个红外接收器

LAN x 1 (RJ45)

12 V 直流触发器 (最大电流 0.5A) x 1

输出

控制

■ 一般规格

投影机重量

4.9 公斤 (10.80 磅)

电源

VAC 100-240V , 6 A , 50-60Hz

功耗

最大 594 ; 待机 < 0.5 W ; 网络待机 < 6 W

工作温度

0°C 到 40°C (无冷凝)

操作湿度

10% - 90% (无冷凝)

(JA)

仕様

☞ 仕様はすべて予告なしに変更されることがあります。

■ 光学仕様

投写システム	I-CHIP DLP™ システム
DMD チップ	SX920 : 0.55" DLP (1024 x 768)、SW921 : 0.65" DLP (1280 x 800)、SU922 : 0.67" DLP (1920 x 1200)
レンズ	F = 2.45 ~ 3.07、f = 15.78 ~ 25.12 mm
投写スクリーンサイズ	60" ~ 240"
ランプ	370 W

■ 電気仕様

互換性	PC : SX920/SW921 : 640 x 480 ~ 1600 x 1200、 SU922 : 640 x 480 ~ 1920 x 1200 ビデオ : NTSC、PAL、SECAM、YPbPr (480i/480p/576i/576p/720p/1080i/1080p)、HDTV (720p/1080i/1080p) タイプ = 60% NTSC
カラースペース	
■ 端末	
入力	アナログ RGB : アナログ RGB : D-sub 15-pin (メス) x 1 HDMI (V. 1.4a) x 2 MHL (V. 2.1) x 1 (HDMI 入力で共有) S ビデオ : Mini DIN 4 ピン x 1 コンポーネントビデオ (Y/CB/CR、Y/PB/PR) x 1 (RGB 入力と共有) コンジットビデオ x 1 RCA オーディオ入力 x 1、PC オーディオ入力 x 1 マイクフォン x 1 RJ45 LAN x 1
出力	アナログ RGB : アナログ RGB : D-sub 15-pin (メス) x 1 オーディオ出力 x 1 スピーカー : 10W x 2
コントロール	シリアルコネクタ : RS232 9 ピン (オス) USB: USB (Type-A) x 1、USB (Mini B type) x 1 IR 受信機 x 2 LAN x 1 (RJ45) 12 VDC (最大 0.5 A) x 1

■ 機械仕様

プロジェクタの重量	4.9 kg (10.80 lbs)
電源	VAC 100-240V、6 A、50-60Hz
消費電力	最大 594 W、スタンバイ < 0.5W、ネットワーク スタンバイ < 3 W
動作温度範囲	0°C ~ 40°C (結露なきこと)
動作湿度	10% ~ 90% (結露なきこと)
【同梱した電源コードセットは本機以外の電気機器で使用できません】	

사양



모든 사양은 사전 통보 없이 변경될 수 있습니다.

■ 광학 사양

영사 시스템 단일칩 DLP™ 시스템
DMD 칩 SX920: 0.55" DLP (1024 x 768); SW921: 0.65" DLP (1280 x 800);
 SU922: 0.67" DLP(1920 x 1200)
 렌즈 F = 2.45 - 3.07, f = 15.78 - 25.12 mm
 영사 스크린 크기 60" - 240"
 램프 370W

■ 전기 사양

호환성 PC: SX920/SW921: 640 x 480 ~ 1600 x 1200;
 SU922: 640 x 480 ~ 1920 x 1200

 비디오 : NTSC, PAL, SECAM, YPbPr (480i/480p/576i/576p/720p/
 1080i/1080p), HDTV (720p/1080i/1080p)
 유형 = 60% NTSC

색공간

■ 단자

입력 아날로그 RGB: D-Sub 15 핀 (암) x 1
 HDMI(V. 1.4a) x 2
 MHL (V. 2.1) x 1 (HDMI 입력과 공유)
 S- 비디오 : 미니 DIN 4 핀 x 1
 컴포넌트 비디오 (Y/CB/CR, Y/Pb/Pr) x 1 (RGB 입력과 공유)
 컴포지트 비디오 x 1
 RCA 오디오 입력 x 1
 PC 오디오 입력 x 1
 마이크 x 1
 RJ45 LAN x 1

 출력 아날로그 RGB: D-Sub 15 핀 (암) x 1
 오디오 출력 x 1
 스피커 : 10W x 2

 컨트롤 직렬 커넥터 : RS232 9 핀 (수)
 USB: USB (A 형) x 1 ; USB (Mini B 형) x 1
 IR 수신기 x 2
 LAN x 1 (RJ45)
 12 V DC 트리거 x 1 (최대 0.5 A)

■ 일반 특징

프로젝터 무게 4.9 kg (10.80 lbs)
 전원 VAC 100-240V, 6 A, 50-60Hz
 소비 전력 Max. 594 W; 대기 < 0.5 W; 네트워크 대기 < 3 W
 작동 온도 0°C ~ 40°C (비용결)
 작동 습도 10% - 90% (비용결)

جميع المواصفات عرضة للتغيير دون سابق إخطار..

■ بصري

نظام العرض

الدقة الأصلية

نظام DLP™ أحادي الشريحة

SX920: ٠,٥٥ بوصة DLP (٧٦٨x١٠٢٤)

SW921: ٠,٦٧ بوصة DLP (٨٠٠x١٢٨٠)

SU922: ٠,٦٧ بوصة DLP (١٢٠٠x١٩٢٠)

البعد البيوري = من ٢,٤٥ إلى ٣,٠٧، البعد البيوري = من ١٥,٧٨ إلى ٢٥,١٢ مم

"٦٠ إلى ١٥٠"

٣٧٠ وات

العديسات

حجم شاشة العرض

المصباح

■ المواصفات الكهربائية

التوافق

الحاسب الشخصي

SX920/SW921: ٤٨٠ x ٦٤٠ إلى ١٦٠٠ x ١٢٠٠

SU922: ٤٨٠ x ٦٤٠ إلى ١٩٢٠ x ١٢٠٠

فيديو

PAL, SECAM, YPbPr (1175)480i/480p/576i/576p/720p/1080i/1080p

NTSC,

HDTV (720p/1080i/1080p)

النوع = NTSC %٦٠

مساحة الألوان

■ أطراف التوصيل

الدخل

RGB تناظري: عدد ١ D-Sub ذو ١٥ دبوسا (أنثى)

٢ x HDMI (V.1.4a)

١ x MHL (V. 2.1) (بالتشارك مع دخل HDMI)

S-Video: عدد ١ منفذ DIN صغير ذو ٤ دبوس

الفيديو المركب (Y/CB/CR + Y/PB/PR) x ١ (بالتشارك مع دخل RGB)

عدد ١ منفذ فيديو مؤلف

عدد ١ صوت RCA

عدد ١ صوت PC

عدد ١ ميكروفون

عدد ١ كبل LAN لشبكة RJ45

RGB تناظري: عدد ١ D-Sub ذو ١٥ دبوسا (أنثى)

عدد ١ خرج صوت

Speaker (مكبر الصوت): ١٠ وات ٢x

منفذ توصيل تسلسلي: منفذ RS232 مزود بعدد ٩ سنون (نكر)

عدد ١ منفذ USB (نوع-A)

عدد ١ منفذ USB من النوع Mini B

عدد ٢ مستقبل أشعة تحت الحمراء

عدد ١ شبكة محلية (RJ45)

عدد ١ مشغل تيار مستمر ١٢ فولت (حد أقصى ١ أمبير)

≥ ٧,٧ كجم (١٠,٣٦ رطل)

فولت تيار متردد يتراوح من ١٠٠-٢٤٠ فولت، ٦٠ أمبير، ٥٠-٦٠ هرتز

الحد الأقصى ٥٩٤ وات؛ الاستعداد ٠,٥ وات؛ استعداد الشبكة ٣ وات

من ٠ إلى ٤٠ درجة مئوية (بدون تكثف)

١٠٪ - ٩٠٪ (بدون تكثف)

الخرج

التحكم

■ خصائص عامة

وزن جهاز العرض

الطاقة

استهلاك الطاقة

درجة حرارة التشغيل

الرطوبة عند التشغيل

- En For further information, please refer to the User Manual in the enclosed CD.
- Fr Pour plus d'informations, veuillez vous référer au Guide Utilisateur livré.
- De Für weitere Informationen beziehen Sie sich bitte auf das mitgelieferte Benutzerhandbuch.
- It Per maggiori informazioni si prega di fare riferimento al Manuale Utente allegato.
- Es Para obtener más información, consulte la Guía del usuario adjunta.
- Pt Para mais informações, consulte o manual do utilizador incluído.
- Nl Raadpleeg voor meer informatie de meegeleverde handleiding.
- RU Более подробно см. руководство пользователя, поставляемое в комплекте.
- Pl Więcej informacji znajduje się w załączonym podręczniku użytkownika.
- Sv Mer information finns i den medföljande användarhandboken.
- Cs Další informace si prosím vyhledejte v příložené uživatelské příručce.
- Tr Daha fazla bilgi için lütfen ekteki CD'de bulunan Kullanıcı Kılavuzu'na bakın.
- Tc 若需要進一步的詳細資料，請參考隨機所附的使用手冊。
- Sc 若需进一步讯息，请参考随机所附的用户指南。
- Ko 좀 더 자세한 정보는, 첨부된 사용 설명서를 참조 하십시오.
- Ja 詳細については、付属のユーザーズガイドを参照してください
- Th โปรดดูข้อมูลเพิ่มเติมในคู่มือผู้ใช้ที่ให้มา
- Ar لمزيد من المعلومات، يُرجى الرجوع إلى دليل المستخدم المرفق.