



Digital Projector User Manual

Warranty and Copyright information

Limited warranty

BenQ warrants this product against any defects in material and workmanship, under normal usage and storage.

Proof of purchase date will be required with any warranty claim. In the event this product is found to be defective within the warranty period, BenQ's only obligation and your exclusive remedy shall be replacement of any defective parts (labor included). To obtain warranty service, immediately notify the dealer from which you purchased the product of any defects.

Important: The above warranty shall be void if the customer fails to operate the product in accordance with BenQ's written instructions, especially the ambient humidity must be in-between 10% and 90%, temperature in-between 0°C and 35°C, altitude lower than 4920 feet, and avoiding to operate the projector in a dusty environment. This warranty gives you specific legal rights, and you may have other rights which vary from country to country.

For other information, please visit www.BenQ.com.

Copyright

Copyright © 2021 by BenQ Corporation. All rights reserved. No part of this publication may be reproduced, transmitted, transcribed, stored in a retrieval system or translated into any language or computer language, in any form or by any means, electronic, mechanical, magnetic, optical, chemical, manual or otherwise, without the prior written permission of BenQ Corporation.

Disclaimer

BenQ Corporation makes no representations or warranties, either expressed or implied, with respect to the contents hereof and specifically disclaims any warranties, merchantability or fitness for any particular purpose. Further, BenQ Corporation reserves the right to revise this publication and to make changes from time to time in the contents hereof without obligation to notify any person of such revision or changes.

*DLP, Digital Micromirror Device and DMD are trademarks of Texas Instruments. Others are copyrights of their respective companies or organizations.

Patents

Please go to <http://patmarking.benq.com/> for the details on BenQ projector patent coverage.

Table of Contents

Warranty and Copyright information	2
Important safety instructions	4
Introduction	7
Shipping contents	7
Projector exterior view	8
Controls and functions.....	9
Positioning your projector	12
Choosing a location	12
Obtaining a preferred projected image size.....	13
Mounting the projector	14
Adjusting the projected image	15
Connection	17
Connecting smart devices	18
Operation	19
Starting up the projector	19
Using the menus	21
Securing the projector	22
Switching input signal	24
Shutting down the projector	24
Direct power off.....	25
Menu operation	26
Menu System	26
Basic menu	30
Advanced menu	32
Maintenance	39
Care of the projector	39
Lamp information	40
Troubleshooting	44
Specifications	45
Projector specifications	45
Dimensions	46
Timing chart.....	47
RS232 command.....	49

Important safety instructions

Your projector is designed and tested to meet the latest standards for safety of information technology equipment. However, to ensure safe use of this product, it is important that you follow the instructions mentioned in this manual and marked on the product.

1. **Please read this manual before you operate your projector.** Save it for future reference.

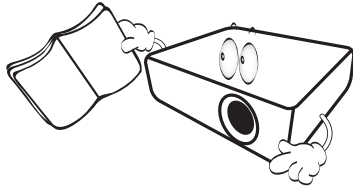

2. **Do not look straight at the projector lens during operation.** The intense light beam may damage your eyes.



3. **Refer servicing to qualified service personnel.**



4. **Always open the lens shutter (if any) or remove the lens cap (if any) when the projector lamp is on.**

5. The lamp becomes extremely hot during operation. Allow the projector to cool for approximately 45 minutes prior to removing the lamp assembly for replacement.



6. In some countries, the line voltage is NOT stable. This projector is designed to operate safely within a mains voltage between 100 to 240 volts AC, but could fail if power cuts or surges of ± 10 volts occur. **In areas where the mains voltage may fluctuate or cut out, it is recommended that you connect your projector through a power stabilizer, surge protector or uninterruptible power supply (UPS).**

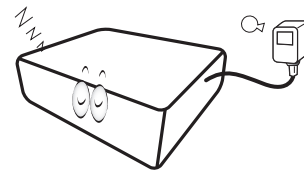

7. Do not block the projection lens with any objects when the projector is under operation as this could cause the objects to become heated and deformed or even cause a fire. To temporarily turn off the lamp, use the blank function.

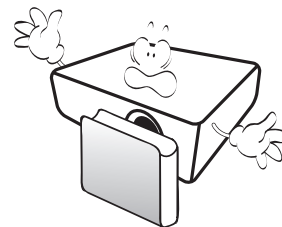

8. Do not operate lamps beyond the rated lamp life. Excessive operation of lamps beyond the rated life could cause them to break on rare occasions.



9. Never replace the lamp assembly or any electronic components unless the projector is unplugged.

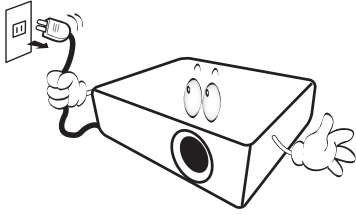

10. Do not place this product on an unstable cart, stand, or table. The product may fall, sustaining serious damage.

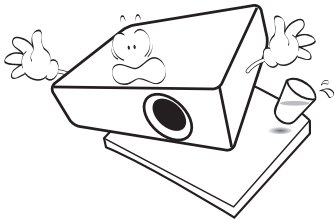

11. Do not attempt to disassemble this projector. There are dangerous high voltages inside which may cause death if you should come into contact with live parts. The only user serviceable part is the lamp which has its own removable cover.

Under no circumstances should you ever undo or remove any other covers. Refer servicing only to suitably qualified professional service personnel.

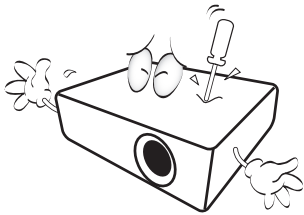

12. Do not block the ventilation holes.

- Do not place this projector on a blanket, bedding or any other soft surface.
- Do not cover this projector with a cloth or any other item.
- Do not place inflammables near the projector.

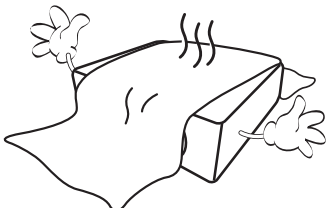

If the ventilation holes are seriously obstructed, overheating inside the projector may result in a fire.

13. Always place the projector on a level, horizontal surface during operation.

- Do not use if tilted at an angle of more than 10 degrees left to right, nor at angle of more than 15 degrees front to back. Using the projector when it is not fully horizontal may cause a malfunction of, or damage to, the lamp.

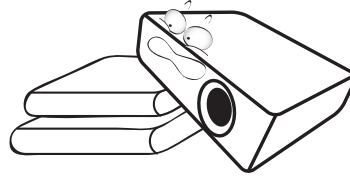

14. Do not stand the projector on end vertically. Doing so may cause the projector to fall over, causing injury or resulting in damage to the projector.

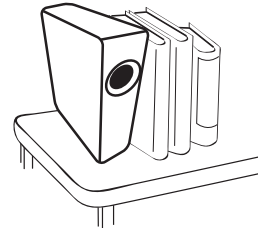

15. Do not step on the projector or place any objects upon it. Besides probable physical damage to the projector, doing so may result in accidents and possible injury.



16. When the projector is under operation, you may sense some heated air and odor from its ventilation grill. It is a normal phenomenon and not a product defect.

17. Do not place liquids near or on the projector. Liquids spilled into the projector may cause it to fail. If the projector does become wet, disconnect it from the power supply's power outlet and call BenQ to have the projector serviced.

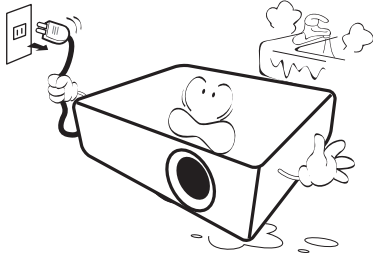

18. This product is capable of displaying inverted images for ceiling/wall mount installation.

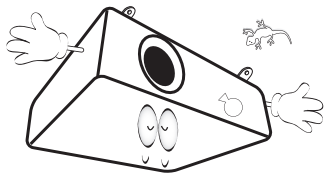

19. This apparatus must be earthed.

20. Do not place this projector in any of the following environments.

- Space that is poorly ventilated or confined. Allow at least 50 cm clearance from walls and free flow of air around the projector.
- Locations where temperatures may become excessively high, such as the inside of a car with all windows rolled up.
- Locations where excessive humidity, dust, or cigarette smoke may contaminate optical components, shorten the projector's life span and darken the image.

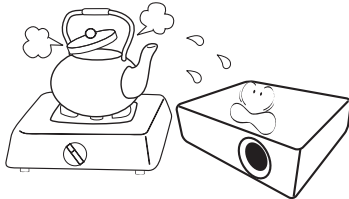

- Locations near fire alarms
- Locations with an ambient temperature above 40°C / 104°F
- Locations where the altitudes are higher than 3000 m (10000 feet).

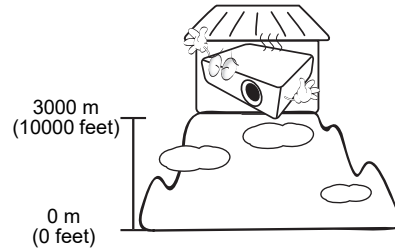

Risk Group 2

1. According to the classification of photobiological safety of lamps and lamp systems, this product is Risk Group 2, IEC 62471-5:2015.
2. Possibly hazardous optical radiation emitted from this product.
3. Do not stare at operating lamp. May be harmful to the eyes.
4. As with any bright source, do not stare into the direct beam.



! Hg - Lamp contains mercury. Manage in accordance with local disposal laws. See www.lamprecycle.org.

! To avoid damaging the DLP chips, never aim a high-power laser beam into the projection lens.

Introduction

Shipping contents

Carefully unpack and verify that you have all of the items shown below. If any of these items are missing, please contact your place of purchase.

Standard accessories

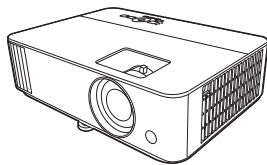

Projector

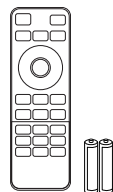

Remote control with batteries



Quick start guide



Warranty card*

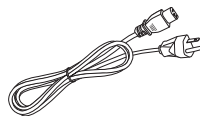

Power cord



• The supplied accessories will be suitable for your region, and may differ from those illustrated.

• *The warranty card is only supplied in some specific regions. Please consult your dealer for detailed information.

Optional accessories

1. Spare lamp kit
2. 3D glasses

Replacing the remote control batteries

1. Press and slide off the battery cover, as illustrated.
2. Remove the old batteries (if applicable) and install two AAA batteries. Make sure that the positive and negative ends are positioned correctly, as illustrated.
3. Slide the battery cover in until it clicks into place.

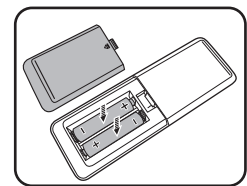
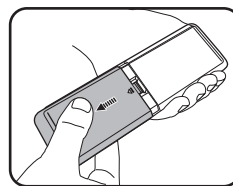

• Avoid leaving the remote control and batteries in an excessive heat or humid environment like the kitchen, bathroom, sauna, sunroom or in a closed car.

• Replace only with the same or equivalent type recommended by the battery manufacturer.

• Dispose of the used batteries according to the manufacturer's instructions and local environment regulations for your region.

• Never throw the batteries into a fire. There may be danger of an explosion.

• If the batteries are dead or if you will not be using the remote control for an extended period of time, remove the batteries to avoid damage to the remote control from possible battery leakage.

Projector exterior view

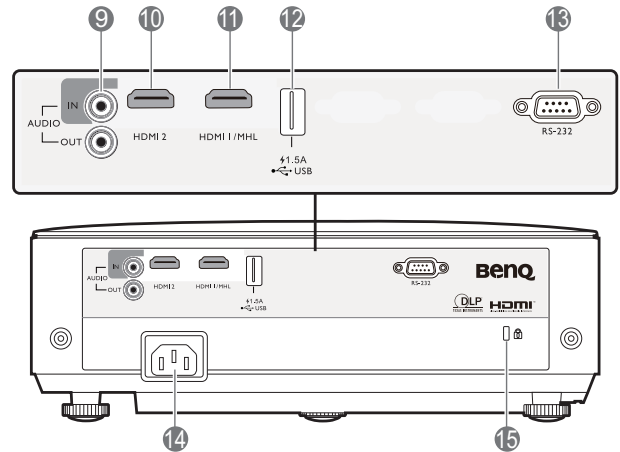
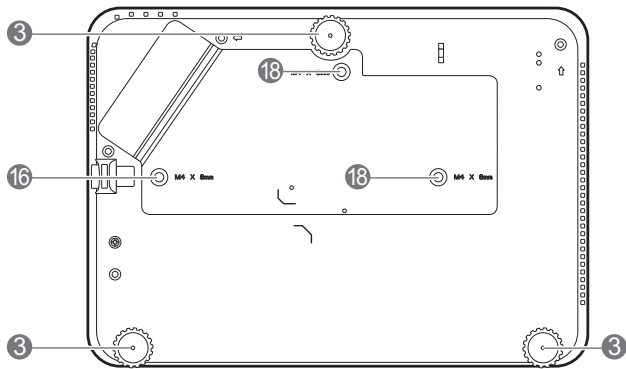
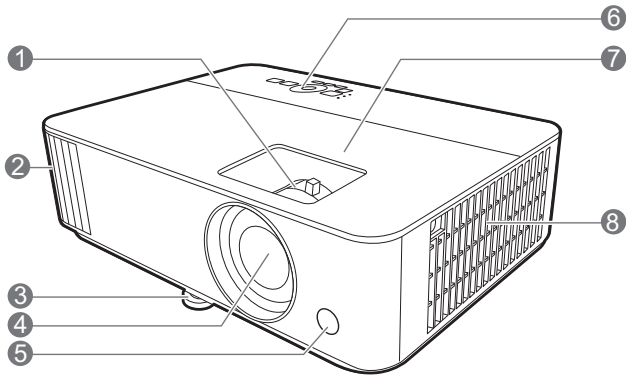

- 1. Focus ring and Zoom ring
- 2. Vent (air exhaust)
- 3. Adjuster feet
- 4. Projection lens
- 5. IR remote sensor
- 6. External control panel
(See [Controls and functions on page 9.](#))
- 7. Lamp cover
- 8. Vent (air inlet)
- 9. Audio input jacks
Audio output jack

- 10. HDMI 2 input port
- 11. HDMI 1/MHL input port
- 12. USB Type A port
- 13. RS-232 control port
- 14. AC power jack
- 15. Kensington anti-theft lock slot
- 16. Ceiling mount holes

Controls and functions

Projector & Remote control



All the key presses described in this document are available on the remote control or projector.

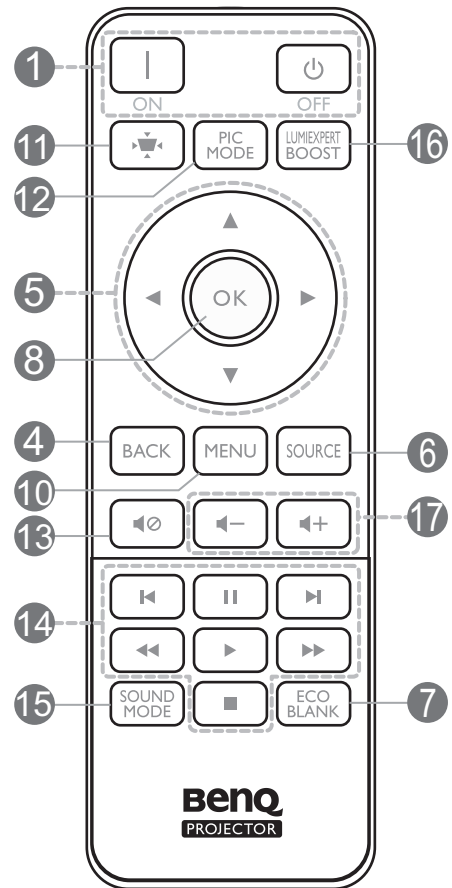
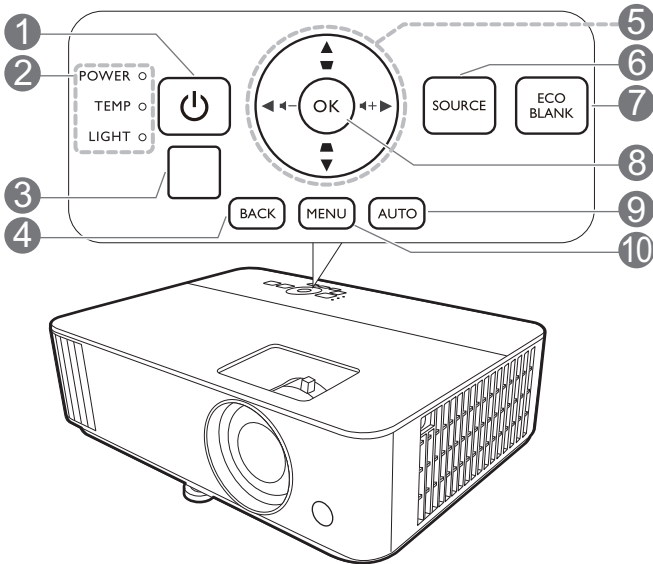

1. **POWER**

Toggles the projector between standby mode and on.

 **ON** /  **Off**

Toggles the projector between standby mode and on.

2. **POWER indicator light/TEMPerature warning light/LIGHT indicator light** (See [Indicators on page 43.](#))

3. IR remote sensor

4. **BACK**

Goes back to previous OSD menu, exits and saves menu settings.

5. Arrow keys (, , ,)

When the On-Screen Display (OSD) menu is activated, these keys are used as directional arrows to select the desired menu items and to make adjustments.

Keystone keys (, )

Displays the keystone correction page.

Volume keys -/

Decreases or increase the projector volume.

6. **SOURCE**

Displays the source selection bar.

7. **ECO BLANK**

Used to hide the screen picture.



Do not block the projection lens from projecting as this could cause the blocking object to become heated and deformed or even cause a fire.

8. **OK**

Confirms the selected On-Screen Display (OSD) menu item.

9. **AUTO**

Automatically determines the best picture timings for the displayed image when PC signal (analog RGB) is selected.

* Available on compatible projectors only.

10. **MENU**

Turns on the On-Screen Display (OSD) menu.

11.

Displays the keystone menu.

12. **PIC MODE**

Selects the picture mode.

13.

Toggles projector audio between on and off.

14. **MHL Zone**

Controls video or audio playback under MHL source.

15. **SOUND MODE**

This projector does not support **SOUND MODE** function.

16. **LUMIEXPERT BOOST**

This projector does not support **LumiExpert** function.

17. Volume keys /

Decreases or increases the projector volume.

Controlling your smart device with the **AUTO** button

When the projector projects the content from your MHL compatible smart device, you can use the remote control to control your smart device.

To enter the MHL mode, press and hold **AUTO** on the projector keypad for 3 seconds. The **MHL Zone** keys on the remote control are available for controlling your smart device.

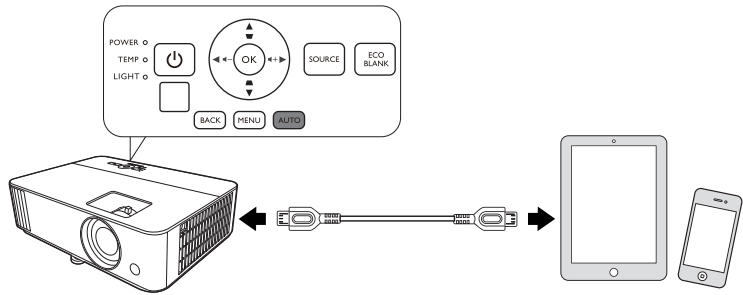

When the projector is under MHL mode, the keypad on the projector should be with the same definition of the keys on the remote control.

Remote control effective range

The remote control must be held at an angle within 30 degrees perpendicular to the projector's IR remote control sensor(s) to function correctly. The distance between the remote control and the sensor(s) should not exceed 8 meters (~ 26 feet).

Make sure that there are no obstacles between the remote control and the IR sensor(s) on the projector that might obstruct the infra-red beam.

- Operating the projector from the front

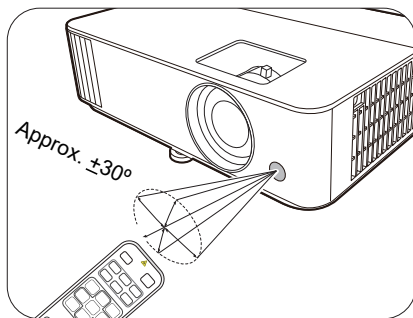

- Operating the projector from the top

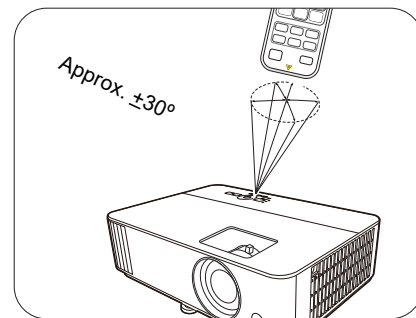

Positioning your projector

Choosing a location

Before choosing an installation location for your projector, take the following factors into consideration:

- Size and position of your screen
- Electrical outlet location
- Location and distance between the projector and the rest of your equipment

You can install your projector in the following ways.

1. Front

Select this location with the projector placed on the table in front of the screen. This is the most common way to position the projector for quick setup and portability.

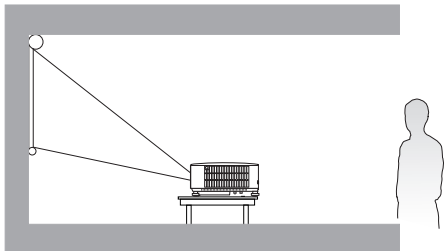

2. Rear

Select this location with the projector placed on the table behind the screen. Note that a special rear projection screen is required.

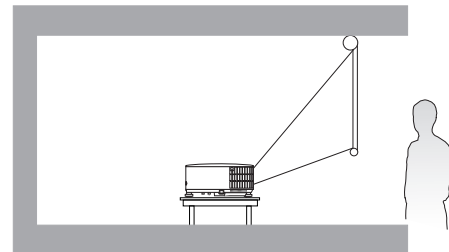

3. Front Ceiling

Select this location with the projector suspended upside-down from the ceiling in front of the screen. Purchase the BenQ Projector Ceiling Mount Kit from your dealer to mount your projector on the ceiling.

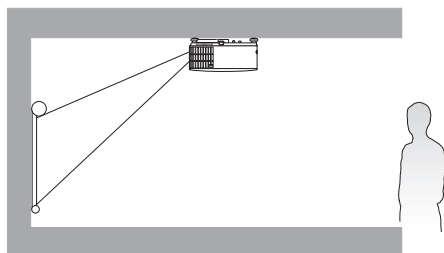

4. Rear Ceiling

Select this location with the projector suspended upside-down from the ceiling behind the screen. Note that a special rear projection screen and the BenQ Projector Ceiling Mount Kit are required for this installation location.

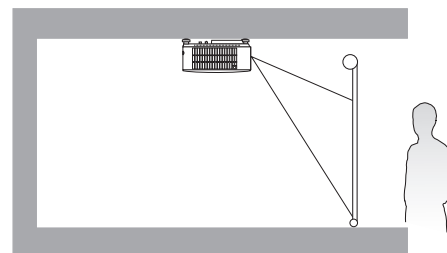

After turning on the projector, go to **Basic Menu - Settings > Projector Installation**, press **OK** and press **◀/▶** to select a setting.

You can also use **QUICK INSTALL** on the remote control to access this menu.

Obtaining a preferred projected image size

The distance from the projector lens to the screen, the zoom setting (if available), and the video format each factors in the projected image size.

Projection dimensions

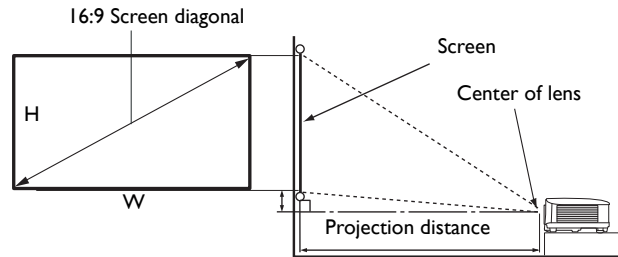

- The screen aspect ratio is 16:9 and the projected picture is in a 16:9 aspect ratio

Screen size		Projection Distance (mm)					Offset (mm)
Diagonal		H (mm)	W (mm)	Min distance (with max zoom)	Average	Max distance (with min zoom)	
Inch	mm						
30	762	374	664	996	1046	1096	19
40	1016	498	886	1328	1395	1461	25
50	1270	623	1107	1660	1743	1826	31
60	1524	747	1328	1992	2092	2192	37
70	1778	872	1550	2324	2441	2557	44
80	2032	996	1771	2657	2789	2922	50
90	2286	1121	1992	2989	3138	3287	56
100	2540	1245	2214	3321	3487	3653	62
110	2794	1370	2435	3653	3835	4018	68
120	3048	1494	2657	3985	4184	4383	75
130	3302	1619	2878	4317	4533	4749	81
140	3556	1743	3099	4649	4881	5114	87
150	3810	1868	3321	4981	5230	5479	93
160	4064	1992	3542	5313	5579	5844	100
170	4318	2117	3763	5645	5927	6210	106
180	4572	2241	3985	5977	6276	6575	112
190	4826	2366	4206	6309	6625	6940	118
200	5080	2491	4428	6641	6973	7306	125
210	5334	2615	4649	6973	7322	7671	131
220	5588	2740	4870	7306	7671	8036	137
230	5842	2864	5092	7638	8019	8401	143
240	6096	2989	5313	7970	8368	8767	149
250	6350	3113	5535	8302	8717	9132	156
260	6604	3238	5756	8634	9066	9497	162
270	6858	3362	5977	8966	9414	9862	168
280	7112	3487	6199	9298	9763	10228	174
290	7366	3611	6420	9630	10112	10593	181
300	7620	3736	6641	9962	10460	10958	187

For example, if you are using a 120-inch screen, the recommended projection distance in the "Average" column is 4184 mm.

If your measured projection distance is 4400 mm, the closest match in the "Average" column is 4533 mm. Looking across this row shows that a 130" (about 3.3 m) screen is required.



To optimize your projection quality, we suggest to do the projection within non-gray area.



All measurements are approximate and may vary from the actual sizes.

BenQ recommends that if you intend to permanently install the projector, you should physically test the projection size and distance using the actual projector in situ before you permanently install it, so as to make allowance for this projector's optical characteristics. This will help you determine the exact mounting position so that it best suits your installation location.

Mounting the projector

If you intend to mount your projector, we strongly recommend that you use a proper fitting BenQ projector mounting kit and that you ensure it is securely and safely installed.

If you use a non-BenQ brand projector mounting kit, there is a safety risk that the projector may fall down due to an improper attachment through the use of the wrong gauge or length screws.

Before mounting the projector

- Purchase a BenQ projector mounting kit from the place you purchased your BenQ projector.
- BenQ recommends that you also purchase a separate Kensington lock compatible security cable and attach it securely to both the Kensington lock slot on the projector and the base of the mounting bracket. This will perform the secondary role of restraining the projector should its attachment to the mounting bracket become loose.
- Ask your dealer to install the projector for you. Installing the projector on your own may cause it to fall and result in injury.
- Take necessary procedures to prevent the projector from falling off such as during an earthquake.
- The warranty doesn't cover any product damage caused by mounting the projector with a non-BenQ brand projector mounting kit.
- Consider the surrounding temperature where the projector is ceiling/wall mounted. If a heater is used, the temperature around the ceiling may be higher than expected.
- Read the user manual for the mounting kit about the range of torque. Tightening with torque exceeding the recommended range may cause damage to the projector and subsequently falling off.
- Make sure the power outlet is at an accessible height so that you can easily shut down the projector.

Ceiling/Wall mount installation diagram

Ceiling/Wall mount screw: M4
(Max L = 25 mm; Min L = 20 mm)

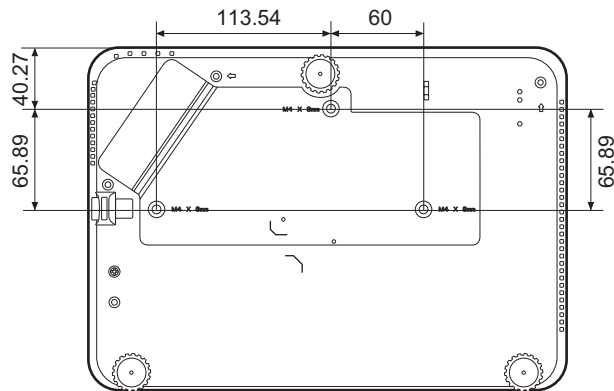

Adjusting the projected image

Adjusting the projection angle

If the projector is not placed on a flat surface or the screen and the projector are not perpendicular to each other, the projected image becomes trapezoidal. You can adjust the adjuster feet to fine-tune the horizontal angle.

To retract the feet, screw the adjuster feet in a reverse direction.

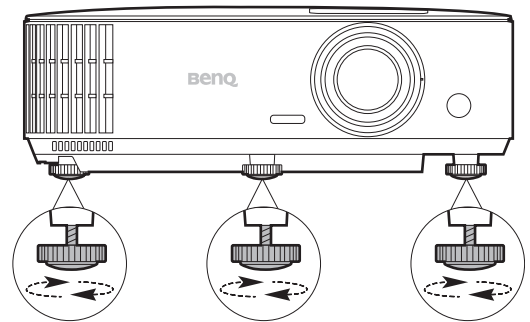

Do not look into the lens while the lamp is on. The strong light from the lamp may cause damage to your eyes.

Fine-tuning the image size and clarity

Adjust the projected image to the size that you need using the zoom ring.

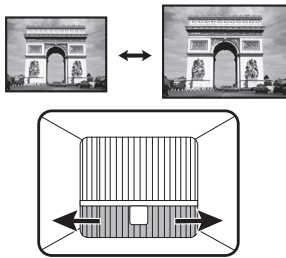

Sharpen the image by rotating the focus ring.

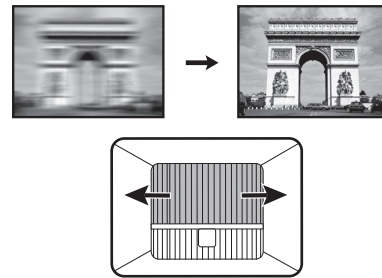

Correcting keystone

Keystoning refers to the situation where the projected image becomes a trapezoid due to angled projection.

To correct this, you will need to manually correct it following these steps.

1. Do one of the following steps to display the keystone correction page.

- Press \triangle / ∇ on the projector.
- Press \square on the remote control.

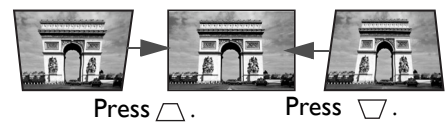

2. After the **Keystone** correction page displays. Press \triangle to correct keystone at the top of the image. Press ∇ to correct keystone at the bottom of the image.

Connection

When connecting a signal source to the projector, be sure to:

1. Turn all equipment off before making any connections.
2. Use the correct signal cables for each source.
3. Ensure the cables are firmly inserted.

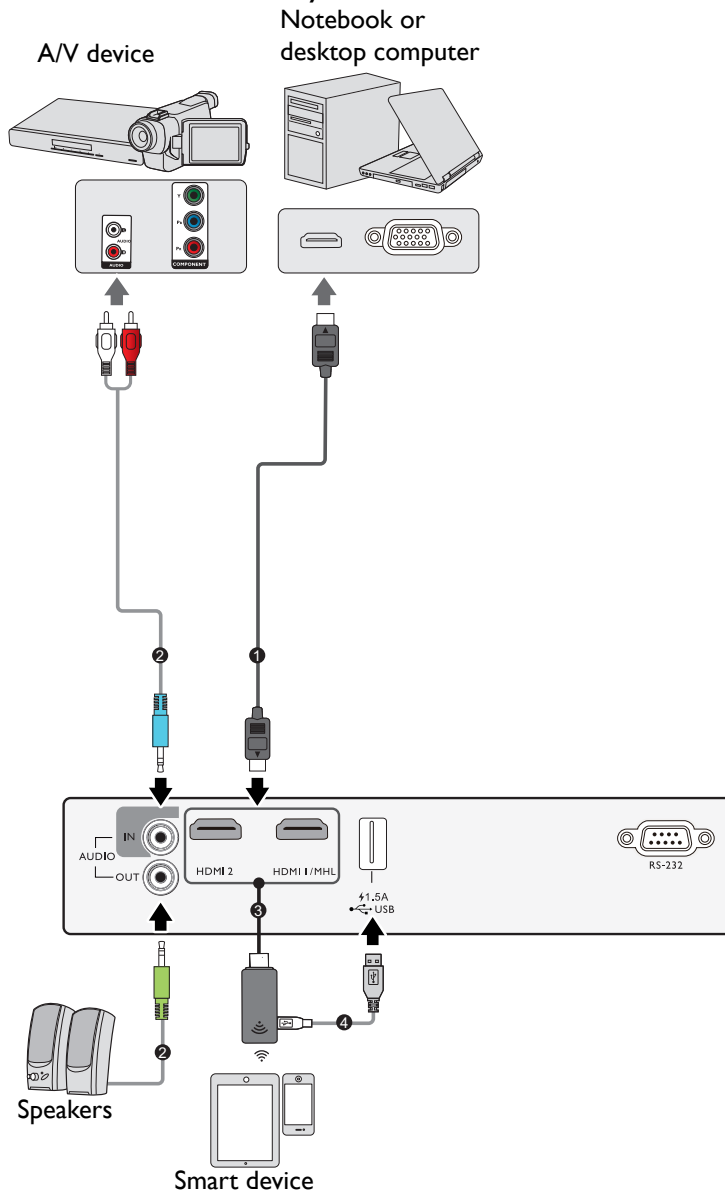

1	HDMI cable
2	Audio cable
3	HDMI wireless dongle
4	USB cable (A to Micro B type) connect to the power port of HDMI wireless dongle.



- In the connections above, some cables may not be included with the projector (see [Shipping contents on page 7](#)). They are commercially available from electronics stores.
- The connection illustrations are for reference only. The rear connecting jacks available on the projector vary with each projector model.
- Many notebooks do not turn on their external video ports when connected to a projector. Usually a key combo like FN + function key with a monitor symbol turns the external display on/off. Press FN and the labeled function key simultaneously. Refer to your notebook's documentation to find your notebook's key combination.
- If the selected video image is not displayed after the projector is turned on and the correct video source has been selected, check that the video source device is turned on and operating correctly. Also check that the signal cables have been connected correctly.

Connecting audio

The projector has built-in mono speaker(s) which are designed to provide basic audio functionality accompanying data presentations for business purposes only. They are not designed for, nor intended for stereo audio reproduction use as might be expected in home theater or home cinema applications. Any stereo audio input (if provided), is mixed into a common mono audio output through the projector speaker(s).

The built-in speaker(s) will be muted when the **AUDIO OUT** jack is connected.



- The projector is only capable of playing mixed mono audio, even if a stereo audio input is connected.
- If the selected video image is not displayed after the projector is turned on and the correct video source has been selected, check that the video source device is turned on and operating correctly. Also check that the signal cables have been connected correctly.

Connecting smart devices

The projector can project the content directly from a smart device by using a wireless dongle.

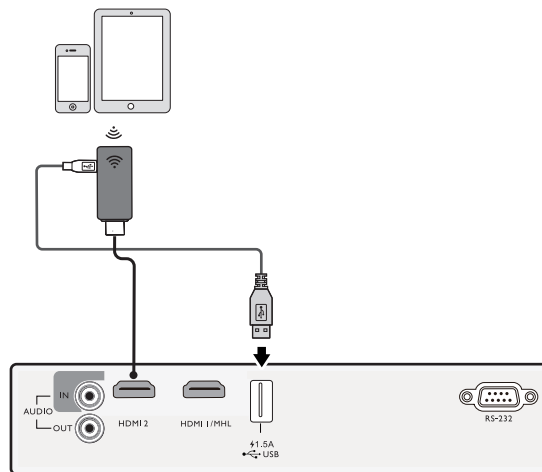

HDMI wireless dongle



Connect the dongle to **HDMI** and **USB TYPE-A** ports on the projector and switch the input signal to **HDMI 1/MHL** or **HDMI 2**.





Operation

Starting up the projector

1. Plug the power cord. Turn on the power outlet switch (where fitted). The power indicator on the projector lights orange after power has been applied.
2. Press  on the projector or  on the remote control to start the projector. The power indicator flashes green and stays green when the projector is on.

The start up procedure takes about 30 seconds. In the later stage of start up, a startup logo is projected.

(If necessary) Rotate the focus ring to adjust the image clearness.

3. If this is the first time you turn on the projector, the setup wizard appears to guide you through setting up the projector. If you have already done this, skip this step and move on to step 5.
 - Use the arrow keys (///) on the projector or remote control to move through the menu items.
 - Use **OK** to confirm the selected menu item.

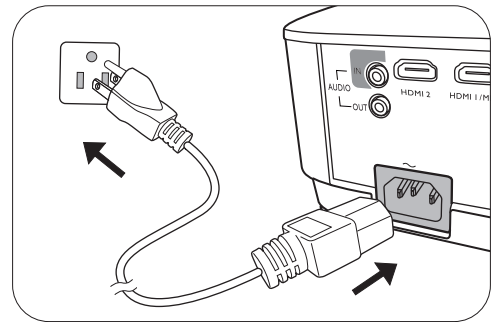

 The Setup Wizard screenshots below are for reference only and may differ from the actual design.

Step 1:

Specify **Projector Position**.



For more information about projector position, see [Choosing a location](#).

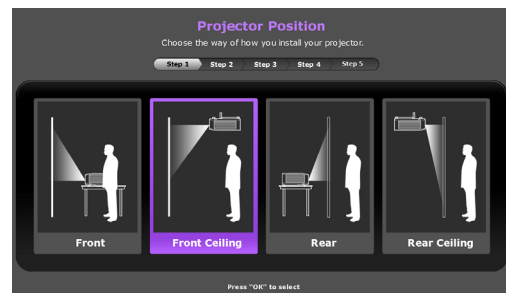

Step 2:

Specify OSD **Language**.

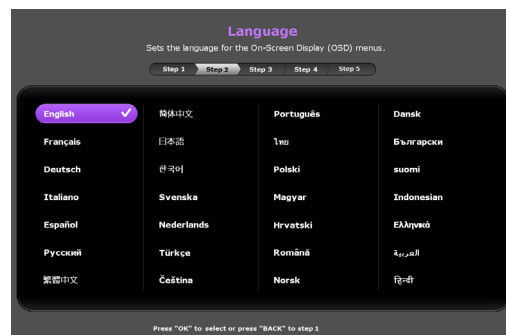

Step 3:

Specify **Vertical Keystone**.



For more information about vertical keystone, see [Correcting keystone](#).

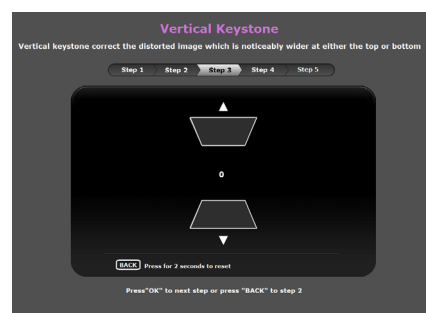

Step 4:
Specify **Auto Source**.

- ✎ Select **On** if you want the projector to always search for available signals automatically when the projector is turned on.

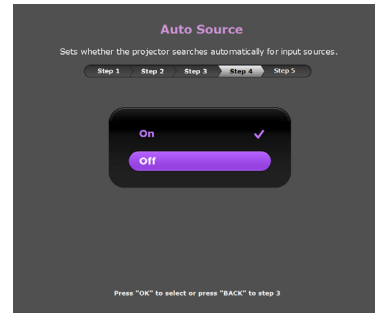

Step 5:
Specify **Menu Type**.

- ✎ For more information about menu types, see [Using the menus](#).

Now you've completed the initial setup.

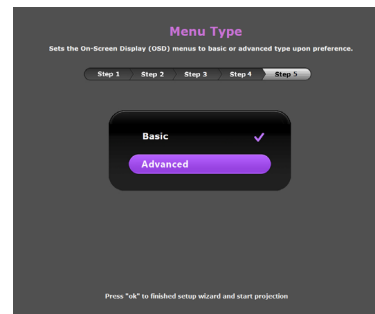

- If you are prompted for a password, press the arrow keys to enter a 6-digit password. See [Utilizing the password function on page 22](#).
- Switch all of the connected equipment on.
- The projector will search for input signals. The current input signal being scanned appears. If the projector does not detect a valid signal, the message “No Signal” will continue displaying until an input signal is found.
You can also press **SOURCE** to select your desired input signal. See [Switching input signal on page 24](#).

- ! Please use the original accessories (e.g. power cord) to avoid possible dangers such as electric shock and fire.
 - If the projector is still hot from previous activity, it will run the cooling fan for approximately 90 seconds before energizing the lamp.
-
- ✎ The Setup Wizard screenshots are for reference only and may differ from the actual design.
 - If the frequency/resolution of the input signal exceeds the projector's operating range, you will see the message “Out of Range” displayed on the background screen. Please change to an input signal which is compatible with the projector's resolution or set the input signal to a lower setting. See [Timing chart on page 47](#).
 - If no signal is detected for 3 minutes, the projector automatically enters saving mode.

Using the menus

The projector is equipped with 2 types of On-Screen Display (OSD) menus for making various adjustments and settings.

- **Basic** OSD menu: provides primary menu functions. (See [Basic menu on page 30](#))
- **Advanced** OSD menu: provides full menu functions. (See [Advanced menu on page 32](#))

To access the OSD menu, press **MENU** on the projector or remote control.

- Use the arrow keys (▲/▼/◀/▶) on the projector or remote control to move through the menu items.
- Use **OK** on the projector or remote control to confirm the selected menu item.

The first time you use the projector (after finishing the initial setup), Basic OSD menu displays.



The OSD screenshots below are for reference only, and may differ from the actual design.

Below is the overview of the **Basic** OSD menu.

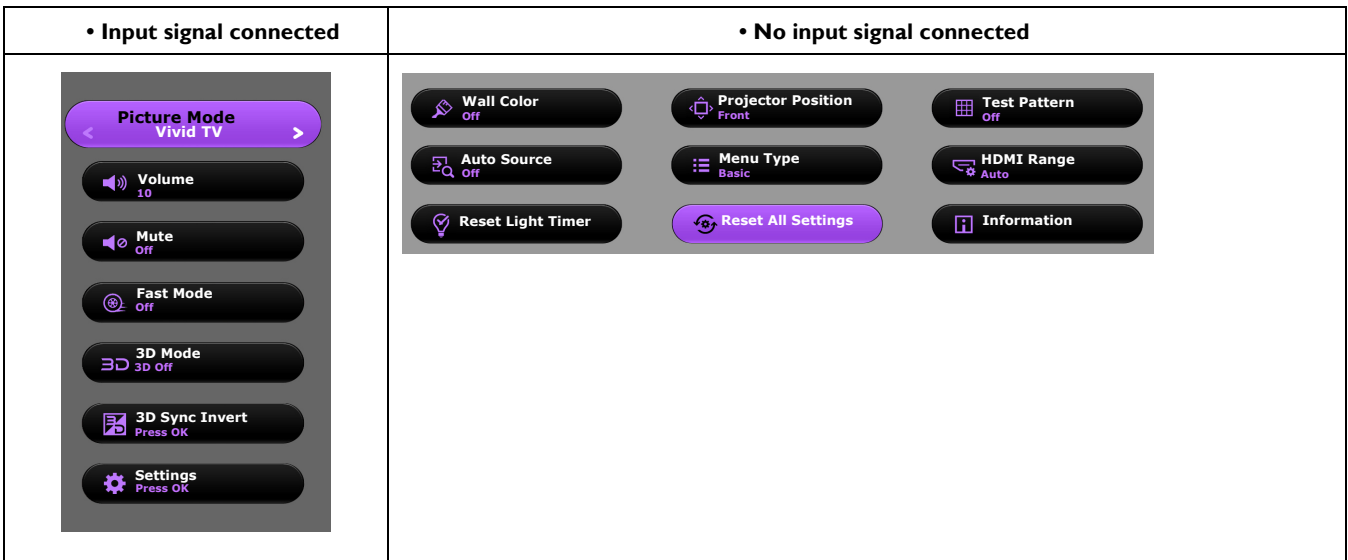

If you intend to switch from the **Basic** OSD menu to the **Advanced** OSD menu, follow the instructions below:

1. Go to **Basic Menu - Settings > Menu Type** and press **OK**.
2. Press ▲/▼ to select **Advanced** and press **OK**. Your projector will switch to **Advanced** OSD menu.

Below is the overview of the **Advanced** OSD menu.

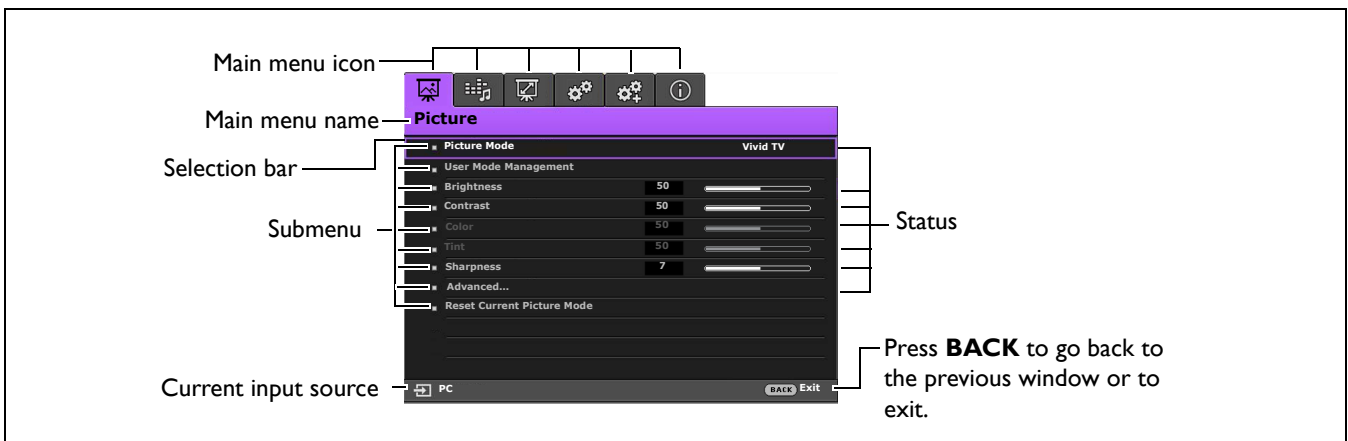

Likewise, when you wish to switch from the **Advanced** OSD menu to the **Basic** OSD menu, follow the instructions below:

1. Go to **Advanced Menu - System Setup : Basic > Menu Settings** and press **OK**.
2. Highlight **Menu Type** and press **◀/▶** to select **Basic**. Your projector will switch to the **Basic** OSD menu.

Securing the projector

Using a security cable lock

The projector has to be installed in a safe place to prevent theft. Otherwise, purchase a lock, such as the Kensington lock, to secure the projector. You can locate a Kensington lock slot on the rear side of the projector. See item 15 on [page 8](#).

A Kensington security cable lock is usually a combination of key(s) and the lock. Refer to the lock's documentation for finding out how to use it.

Utilizing the password function

Setting a password

1. Go to **Advanced Menu - System Setup : Advanced > Password**. Press **OK**. The **Password** page appears.
2. Highlight **Change Password** and press **OK**.
3. The four arrow keys (**▲**, **▶**, **▼**, **◀**) respectively represent 4 digits (1, 2, 3, 4). According to the password you desire to set, press the arrow keys to enter six digits for the password.
4. Confirm the new password by re-entering the new password.
Once the password is set, the OSD menu returns to the **Password** page.
5. To activate the **Power On Lock** function, press **▲/▼** to highlight **Power On Lock** and press **◀/▶** to select **On**. Input the password again.

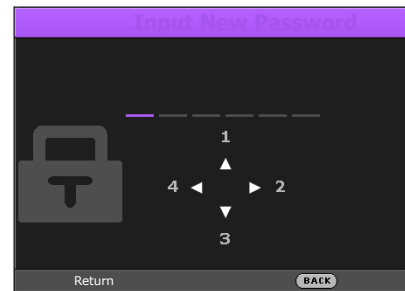

- The digits being input will display as asterisks on-screen. Make a note of your selected password and keep it in a safe place in advance or right after the password is entered so that it is available to you should you ever forget it.
- Once a password has been set and the power on lock is activated, the projector cannot be used unless the correct password is entered every time the projector is started.

If you forget the password

If you enter the wrong password, the password error message will appear, and the **Input Current Password** message follows. If you absolutely do not remember the password, you can use the password recall procedure. See [Entering the password recall procedure on page 23](#).

- Under the **Advanced OSD** menu

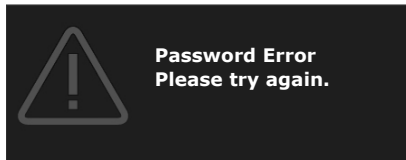

- Under the **Basic OSD** menu

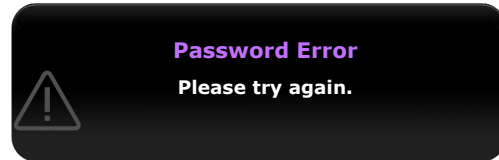

If you enter an incorrect password 5 times in succession, the projector will automatically shut down in a short time.

Entering the password recall procedure

1. Press and hold **AUTO** for 3 seconds. The projector will display a coded number on the screen.

- Under the **Advanced OSD** menu

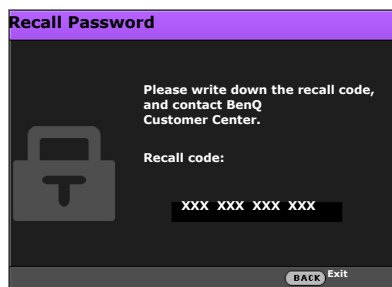

- Under the **Basic OSD** menu

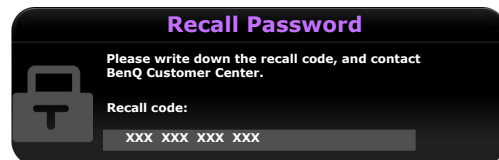

2. Write down the number and turn off your projector.
3. Seek help from the local BenQ service center to decode the number. You may be required to provide proof of purchase documentation to verify that you are an authorized user of the projector.

Changing the password

1. Go to **Advanced Menu - System Setup : Advanced > Password**. Press **OK**. The **Password** page appears.
2. Highlight **Change Password** and press **OK**. The message **"Input Current Password"** appears.
3. Enter the old password.
 - If the password is correct, another message **"Input New Password"** appears.
 - If the password is incorrect, the password error message will appear, and the message **"Input Current Password"** appears for your retry. You can press **BACK** to cancel the change or try another password.
4. Enter a new password.
5. Confirm the new password by re-entering the new password.

Disabling the password function

To disable password protection, go to **Advanced Menu - System Setup : Advanced > Password > Power On Lock** and press **◀/▶** to select **Off**. The message **"Input Current Password"** appears. Enter the current password.

- If the password is correct, the OSD menu returns to the **Security Settings** page. You will not have to enter the password next time turning on the projector.

- If the password is incorrect, the password error message will appear, and the message “**Input Current Password**” appears for your retry. You can press **BACK** to cancel the change or try another password.

 Though the password function is disabled, you need to keep the old password in hand should you ever need to re-activate the password function by entering the old password.

Switching input signal

The projector can be connected to multiple devices at the same time. However, it can only display one full screen at a time. When starting up, the projector automatically searches for the available signals.

Be sure the **Advanced Menu - System Setup : Basic > Auto Source** menu is **On** if you want the projector to automatically search for the signals.

To select the source:



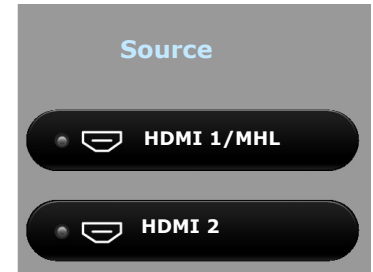

1. Press **SOURCE**. A source selection bar appears.
2. Press **▲/▼** until your desired signal is selected and press **OK**.

Once detected, the selected source information will appear at the corner of the screen for seconds. If there is multiple equipment connected to the projector, repeat steps 1-2 to search for another signal.



- The brightness level of the projected image will change accordingly when you switch between different input signals.
- For best display picture results, you should select and use an input signal which outputs at the projector's native resolution. Any other resolutions will be scaled by the projector depending upon the “aspect ratio” setting, which may cause some image distortion or loss of picture clarity. See [Aspect Ratio on page 35](#).

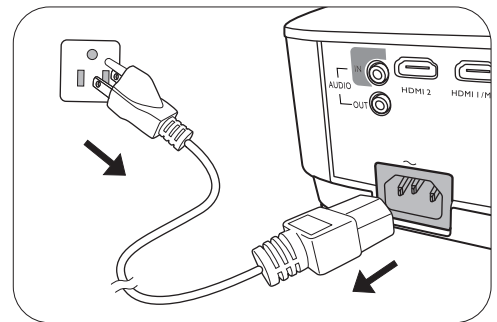

Shutting down the projector

1. Press  on the projector or  on the remote control and a confirmation message will appear prompting you. If you don't respond in a few seconds, the message will disappear.
2. Press  or  a second time. The power indicator flashes orange, the projection lamp shuts down, and the fans will continue to run for approximately 90 seconds to cool down the projector.
3. Once the cooling process finishes, the power indicator becomes a steady orange and fans stop. Disconnect the power cord from the power outlet.



- To protect the lamp, the projector will not respond to any commands during the cooling process.
- To shorten the cooling time, you can also activate the Quick cooling function. See [Quick Cooling on page 37](#).
- Avoid turning on the projector immediately after turning it off as excessive heat may shorten lamp life.
- Lamp life results will vary depending on environmental conditions and usage.

Direct power off

The AC power cord can be pulled out right after the projector is turned off. To protect the lamp, wait about 10 minutes before re-starting the projector. If you attempt to re-start the projector, the fans may run for a few minutes to cool down. In such cases, press  or  again to start the projector after the fans stop and the power indicator turns orange.

Menu operation

Please note that the on-screen display (OSD) menus vary according to the signal type selected and the projector model you are using.

The menu items are available when the projector detects at least one valid signal. If there is no equipment connected to the projector or no signal detected, limited menu items are accessible.

Menu System

Basic Menu

Sub-menu	Options
Picture Mode	Bright/Living Room/Cinema/Game/Sports/ User 1/User 2/(3D)
Volume	0~10~20
Mute	On/Off
Fast Mode	On/Off
3D Mode	Auto/3D Off/Frame Sequential/ Frame Packing/Top-Bottom/Side-by-Side
3D Sync Invert	
Settings	

Advanced Menu



Main menu	Sub-menu	Options	
PICTURE	Picture Mode	Bright/Living Room/Cinema/Sports/ Game/User 1/User 2/(3D)	
	User Mode Management	Bright/Living Room/Cinema/Sports/ Game/User 1/User 2 Rename User Mode	
	Brightness	0~50~100	
	Contrast	0~50~100	
	Sharpness	0~7~15	
		Gamma Selection	1.6/1.8/2.0/2.1/2.2/2.3/2.4/2.6/2.8/ BenQ
			Preset (Normal/Cool/Lamp Native/ Warm)
			Red Gain (0~200)
		Color Temperature	Green Gain (0~200)
			Blue Gain (0~200)
			Red Offset (0~511)
			Green Offset (0~511)
			Blue Offset (0~511)
		Advanced	R (Hue/Saturation/Gain)
			G (Hue/Saturation/Gain)
		Color Management	B (Hue/Saturation/Gain)
			C (Hue/Saturation/Gain)
			M (Hue/Saturation/Gain)
			Y (Hue/Saturation/Gain)
			White (R Gain/G Gain/B Gain)
	Noise Reduction	0~31	
	Brilliant Color	0~10	
	Fast Mode	On/Off	
	Light Mode	Normal/Economic/SmartEco/ LampSave	
	Reset Current Picture Mode	Reset/Cancel	
Sound	Mute	On/Off	
	Volume	0~10~20	
	Power On/Off Ring Tone	On/Off	
	Reset Audio Settings	Reset/Cancel	

Main menu	Sub-menu	Options	
DISPLAY	Aspect Ratio	Auto/Real/4:3/16:9/16:10	
	Wall Color	Off/Light Yellow/Pink/Green/Blue	
	Overscan Adjustment	0~1~3	
	3D	3D Mode	Auto/3D Off/Frame Sequential/ Frame Packing/Top-Bottom/ Side-by-Side
		3D Sync Invert	
	Digital Lens Shift	-20~0~20	
SYSTEM SETUP: BASIC	Language	English/Français/Deutsch/Italiano/Español/ Русский/繁體中文/简体中文/日本語/한국어/ Svenska / Nederlands/Türkçe/Čeština/ Português/ไทย/Polski/Magyar/Hrvatski/ Română/Norsk/Dansk/Български/ Suomi/Indonesian/Ελληνικά/العربية/हिंदी	
	Background Color	Black/Blue/Purple	
	Splash Screen	BenQ/Black/Blue	
	Projector Position	Front/Front Ceiling/Rear Rear Ceiling	
	Auto Off	Disable/5 min/10 min/15 min/ 20 min/25 min/30 min	
	Direct Power On	On/Off	
	Menu Settings	Menu Type	Basic/Advanced
		Menu Position	Center/Top-Left/Top-Right/ Bottom-Right/Bottom-Left
		Menu Display Time	Always On/5 sec/10 sec/15 sec/ 20 sec/25 sec/30 sec
		Blank Reminder Message	On/Off
	Source Rename		
	Auto Source	On/Off	

Main menu	Sub-menu	Options	
SYSTEM SETUP: ADVANCED	Light Settings	Reset Light Timer	Reset/Cancel
		Light Usage Time	
	HDMI Settings	HDMI Range	Auto/Full/Limited
	Baud Rate		9600/14400/19200/38400/57600/115200
	Test Pattern		On/Off
	Quick Cooling		On/Off
	High Altitude Mode		On/Off
	Password	Change Password	
		Power On Lock	On/Off
	Key Lock		On/Off
	LED Indicator		On/Off
	Reset All Settings		Reset/Cancel
	INFORMATION	Source	
		Picture Mode	
Resolution			
Color System			
Light Usage Time			
3D Format			
Firmware Version			
Service Code			

Basic menu

<p>Picture Mode</p>	<p>The projector is preset with several predefined picture modes so that you can choose one to suit your operating environment and input signal picture type.</p> <ul style="list-style-type: none"> • Bright: Maximizes the brightness of the projected image. This mode is suitable for environments where extra-high brightness is required, such as using the projector in well lit rooms. • Living Room: Being slightly brighter than Cinema mode, it is suitable for playing movies in rooms where there is a small amount of ambient light, eg. your living room. • Cinema: With well-balanced color saturation and contrast with a low brightness level, this is most suitable for enjoying movies in a totally dark environment (as you would find in a commercial cinema). • Sports: This mode is best for watching sporting events in rooms where there is a small amount of ambient light, et. your living room. • Game: This mode is best for playing video games in rooms where there is a small amount of ambient light, eg. your living room. • User 1/User 2: Recalls the settings customized based on the current available picture modes. See User Mode Management on page 32.
<p>Volume</p>	<p>Adjusts the sound level.</p>
<p>Mute</p>	<p>Temporarily turns off the sound.</p>
<p>Fast Mode</p>	<p>Select to turn On or Off the Fast Mode.</p>
<p>3D Mode</p>	<p>This projector supports playing three-dimensional (3D) content transferred through your 3D-compatible video devices and contents, such as PlayStation consoles (with 3D game discs), 3D Blu-ray players (with 3D Blu-ray discs), 3D TV (with 3D channel), and so on. After you have connected the 3D video devices to the projector, wear the BenQ 3D glasses and make sure the power is on to view 3D contents.</p> <p> When watching 3D contents,</p> <ul style="list-style-type: none"> • the image may seem misplaced, however, this is not a product malfunction. • take appropriate breaks when watching 3D content. • stop watching 3D content if you feel fatigue or discomfort. • keep a distance from the screen of about three times the effective height of the screen when watching 3D content. • children and people with a history of oversensitivity to light, heart problems, or have any other existing medical condition should be refrained from watching 3D content.



<p>3D Mode</p>	<p>The default setting is Auto and the projector automatically chooses an appropriate 3D format when detecting 3D contents. If the projector cannot recognize the 3D format, manually choose a 3D mode according to your preference.</p> <p> When this function is enabled:</p> <ul style="list-style-type: none"> • The brightness level of the projected image decreases. • The Picture Mode cannot be adjusted. • The Vertical Keystone can only be adjusted within limited degrees. <p> The function is accessible through the remote control.</p>
<p>3D Sync Invert</p>	<p>When your 3D image is distorted, enable this function to switch between the image for the left eye and the right eye for comfortable 3D viewing experience.</p> <p> The function is accessible through the remote control.</p>
<p>Settings</p>	<p>Press OK to enter its submenu.</p> <p>Press BACK to save your changes and exit.</p> <p>See below for more details.</p>

Advanced menu

Picture

Picture Mode	<p>The projector is preset with several predefined picture modes so that you can choose one to suit your operating environment and input signal picture type.</p> <ul style="list-style-type: none">• Bright: Maximizes the brightness of the projected image. This mode is suitable for environments where extra-high brightness is required, such as using the projector in well lit rooms.• Living Room: Being slightly brighter than Cinema mode, it is suitable for playing movies in rooms where there is a small amount of ambient light, eg. your living room.• Cinema: With well-balanced color saturation and contrast with a low brightness level, this is most suitable for enjoying movies in a totally dark environment (as you would find in a commercial cinema).• Sports: This mode is best for watching sporting events in rooms where is a small amount of ambient light, et. your living room.• Game: This mode is best for playing video games in rooms where there is a small amount of ambient light, eg. your living room.• User 1/User 2: Recalls the settings customized based on the current available picture modes. See User Mode Management on page 32.• 3D: Is appropriate for playing 3D images and 3D video clips.
User Mode Management	<p>There are 2 user-definable modes if the current available picture modes are not suitable for your need. You can use one of the picture modes (except the User 1/User 2) as a starting point and customize the settings.</p> <ol style="list-style-type: none">1. Go to Picture > Picture Mode.2. Press ◀/▶ to select User 1 or User 2.3. Press ▼ to highlight User Mode Management and press OK.4. Highlight Load Settings From and press OK.5. Press ▼ to select a picture mode that is close to your need.6. When done, press OK and BACK to return to the Picture menu.7. Press ▼ to select other submenus you want to make changes and use ◀/▶ to adjust the values. The adjustments define the selected user mode. <ul style="list-style-type: none">• Rename User Mode <p>Select to rename the customized picture modes (User 1 or User 2).</p> <ol style="list-style-type: none">1. Go to the Picture > Picture Mode menu, select User 1 or User 2.2. Press ▼ to select User Mode Management.3. On the User Mode Management window, select Rename User Mode and press OK.4. On the Rename User Mode window, use ▲/▼/◀/▶ to select desired characters for the selected mode.5. When done, press OK and BACK to exit.

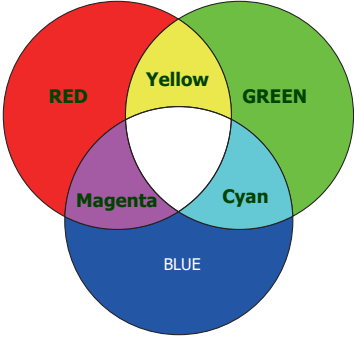
Brightness	The higher the value, the brighter the image. Adjust this control so the black areas of the image appear just as black and that detail in the dark areas is visible.
Contrast	The higher the value, the greater the contrast. Use this to set the peak white level after you have previously adjusted the Brightness setting to suit your selected input and viewing environment.
Sharpness	The higher the value, the sharper the picture becomes.
Advanced	<p>Gamma Selection</p> <p>Gamma refers to the relationship between input source and picture brightness.</p> <ul style="list-style-type: none"> • 1.6/1.8/2.0/2.1: Select these values according to your preference. • 2.2/2.3: Increases the average brightness of the picture. Best for a lit environment, meeting room or family room. • 2.4: Best for viewing movies in a dark environment. • 2.6/2.8/BenQ: Best for viewing movies which are mostly composed of dark scenes. <div data-bbox="630 734 1200 878" style="text-align: center;"> <p>The slider shows a gradient from light to dark. Labels above the slider: 'High Brightness' and 'Low Contrast' on the left; 'Low Brightness' and 'High Contrast' on the right. Numerical values below the slider: 1.6, 1.8, 2.0, 2.1, 2.2, 2.3, 2.4, 2.6, 2.8, BenQ.</p> </div>
	<p>Color Temperature</p> <p>There are several preset color temperature settings available. The available settings may vary according to the signal type selected.</p> <ul style="list-style-type: none"> • Lamp Native: With the lamp's original color temperature and higher brightness. This setting is suitable for environments where high brightness is required, such as projecting pictures in well lit rooms. • Warm: Makes images appear reddish white. • Normal: Maintains normal colorings for white. • Cool: Makes images appear bluish white.

Advanced	<p>Color Management</p> <p>This function provides six sets (RGBCMY) of colors to be adjusted. When you select each color, you can independently adjust its range and saturation according to your preference.</p> <ul style="list-style-type: none"> • Primary Color: Selects a color from among R (Red), G (Green), B (Blue), C (Cyan), M (Magenta), or Y (Yellow). • Hue: Increase in the range will include colors consisted of more proportions of its two adjacent colors. Please refer to the illustration for how the colors relate to each other. For example, if you select Red and set its range at 0, only pure red in the projected picture will be selected. Increasing its range will include red close to yellow and red close to magenta. • Saturation: Adjusts the values to your preference. Every adjustment made will reflect to the image immediately. For example, if you select Red and set its value at 0, only the saturation of pure red will be affected.  <p> Saturation is the amount of that color in a video picture. Lower settings produce less saturated colors; a setting of “0” removes that color from the image entirely. If the saturation is too high, that color will be overpowering and unrealistic.</p> <ul style="list-style-type: none"> • Gain: Adjusts the values to your preference. The contrast level of the primary color you select will be affected. Every adjustment made will reflect to the image immediately.
	<p>Noise Reduction</p> <p>Reduces electrical image noise caused by different media players. The higher the value, the less the noise.</p>
	<p>Brilliant Color</p> <p>This function utilizes a new color-processing algorithm and system level enhancements to enable higher brightness while providing truer, more vibrant colors in picture. It enables a greater than 50% brightness increase in mid-tone images, which are common in video and natural scenes, so the projector reproduces images in realistic and true colors. If you prefer images with that quality, select On. Selecting Off disables Brilliant Color, and Color Temperature becomes unavailable for access at the same time.</p>
	<p>Fast Mode</p> <p>Select to turn On or Off the Fast Mode.</p>
	<p>Light Mode</p> <p>Select the Light Mode. The options are Normal, Economic, SmartEco, and LampSave.</p>
<p>Reset Current Picture Mode</p>	<p>Returns all of the adjustments you’ve made for the Picture menu to the factory preset values.</p>

Sound

Mute	Temporarily turns off the sound.
Volume	Adjusts the sound level.
Power On/Off Ring Tone	Sets the ring tone for the projector On or Off .
Reset Audio Settings	All of the adjustments you've done under the Sound menu return to the factory preset values.

Display

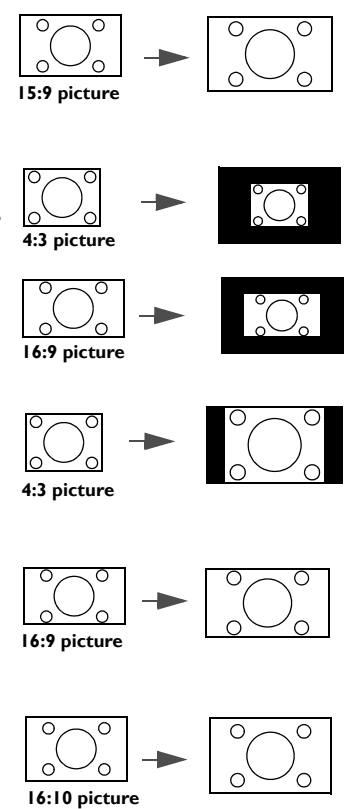

<p>Aspect Ratio</p>	<p>There are several options to set the image's aspect ratio depending on your input signal source.</p> <ul style="list-style-type: none"> • Auto: Scales an image proportionally to fit the projector's native resolution in its horizontal or vertical width. • Real: Projects an image as its original resolution and resizes it to fit within the display area. For input signals with lower resolutions, the projected image will be displayed in its original size. • 4:3: Scales the picture so that it is displayed in the center of the screen with a 4:3 aspect ratio. • 16:9: Scales an image so that it is displayed in the center of the screen with a 16:9 aspect ratio. • 16:10: Scales an image so that it is displayed in the center of the screen with a 16:10 aspect ratio. 
<p>Wall Color</p>	<p>Corrects the projected picture's color when the projection surface such as a painted wall which may not be white, the Wall Color feature can help correct the projected picture's colors to prevent possible color difference between the source and projected pictures. There are several precalibrated colors to choose from: Light Yellow, Pink, Green, and Blue.</p>
<p>Overscan Adjustment</p>	<p>Conceals the poor picture quality in the four edges.</p> <p>The greater the value, the more portion of the picture is concealed while the screen remains filled and geometrically accurate. Setting 0 means the picture is 100% displayed.</p>



<p>3D</p>	<p>This projector features a 3D function which enables you to enjoy the 3D movies, videos, and sporting events in a more realistic way by presenting the depth of the images. You need to wear a pair of 3D glasses to view the 3D images.</p> <ul style="list-style-type: none"> • 3D Mode: The default setting is Off. If you want the projector to automatically choose an appropriate 3D format when detecting 3D contents, select Auto. If the projector cannot recognize the 3D format, press ▲/▼ to choose a 3D mode from among Top Bottom, Frame Sequential, Frame Packing and Side by Side.  <p>When 3D function is activated:</p> <ul style="list-style-type: none"> • The brightness level of the projected image will decrease. • The following settings cannot be adjusted: Picture Mode, Reference Mode. • The Keystone can only be adjusted within limited degrees. • 3D Sync Invert: When you discover the inversion of the image depth, enable this function to correct the problem.
<p>Digital Lens Shift</p>	<p>Use ▲/▼ to vertically shift the projected image.</p>

System Setup : Basic

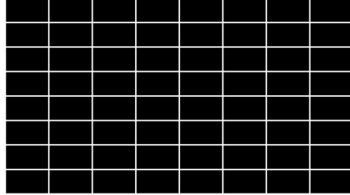
<p>Language</p>	<p>Sets the language for the On-Screen Display (OSD) menus.</p>
<p>Background Color</p>	<p>Sets the background color for the projector.</p>
<p>Splash Screen</p>	<p>Allows you to select which logo screen will be displayed during projector start-up.</p>
<p>Projector Position</p>	<p>See Choosing a location on page 12.</p>
<p>Auto Off</p>	<p>Allows the projector to turn off automatically if no input signal is detected after a set period of time to prevent unnecessary waste of lamp life.</p>
<p>Direct Power On</p>	<p>Allows the projector to turn on automatically once the power is fed through the power cord.</p>
<p>Menu Settings</p>	<ul style="list-style-type: none"> • Menu Type: Switches to the Basic OSD menu. • Menu Position: Sets the OSD menu position. • Menu Display Time: Sets the length of time the OSD will remain active after your last key press. • Blank Reminder Message: Sets whether the reminder message is displayed by the projector while the image is hidden.
<p>Source Rename</p>	<p>Renames the current input source to your desired name.</p> <p>On the Source Rename window, use ▲/▼/◀/▶ to set the desired characters for the connected source item.</p> <p>When done, press OK to save the changes.</p>
<p>Auto Source</p>	<p>Allows the projector to automatically search for a signal.</p>

System Setup : Advanced

Light Settings	<ul style="list-style-type: none"> • Reset Light Timer: See Timing of replacing the lamp (FOR SERVICE PERSONNEL ONLY) on page 41. • Light Usage Time: Displays the number of hours the light has been used.
HDMI Settings	HDMI Range: Sets the HDMI Range to Auto , Full , or Limited .
Baud Rate	Selects a baud rate that is identical with your computer's so that you can connect the projector using a suitable RS-232 cable and update or download the projector's firmware. This function is intended for qualified service personnel.
Test Pattern	Adjusts the image size and focus and check that the projected image is free from distortion. 
Quick Cooling	Select On enables the function and projector cooling time will be shortened from a normal 90-second duration to approximately 15 seconds.
High Altitude Mode	<p>We recommend you use the High Altitude Mode when your environment is between 1500 m –3000 m above sea level, and ambient temperature is between 0°C–30°C.</p> <p>Operation under "High Altitude Mode" may cause a higher decibel operating noise level because of increased fan speed necessary to improve overall system cooling and performance.</p> <p>If you use this projector under other extreme conditions excluding the above, it may display auto shut-down symptoms, which is designed to protect your projector from over-heating. In cases like this, you should switch to High Altitude mode to solve these symptoms. However, this is not to state that this projector can operate under any and all harsh or extreme conditions.</p>  <p>Do not use the High Altitude Mode if your altitude is between 0 m and 1500 m and ambient temperature is between 0°C and 35°C. The projector will be over cooled, if you turn the mode on under such a condition.</p>
Password	<p>For security purposes and to prevent unauthorized use, you may set up password security for the projector. See Utilizing the password function for details.</p> <ul style="list-style-type: none"> • Change Password You will be asked to enter the current password before changing to a new one. • Power On Lock Limits use of the projector to only those who know the correct password.

<p>Key Lock</p>	<p>With the control keys on the projector locked, you can prevent your projector settings from being changed accidentally (by children, for example).</p> <p>When you select On to enable this function, no control keys on the projector will function, except  POWER.</p> <p>To unlock the keys, press and hold  on the projector for 3 seconds.</p>
<p>LED Indicator</p>	<p>When you select On, all LED indicators on the projector function normally. See Indicators for more details.</p> <p>When you select Off, the LED indicators are off after you turn on the projector and the splash screen displays. However, if the projector is not working properly, the LED indicators light or flash to remind you that a problem may occur. See also Indicators for more details.</p>
<p>Reset All Settings</p>	<p>Returns all settings to the factory preset values.</p> <p> The following settings will still remain: Picture, Keystone, Language, Projector Position, Menu Type, Password, Key Lock, Reset Light Timer, and High Altitude Mode.</p>

Information

<p>Information</p>	<ul style="list-style-type: none"> • Source: Shows the current signal source. • Picture Mode: Shows the selected mode in the Picture menu. • Resolution: Displays the native resolution of the input source. • Color System: Shows input system format. • Light Usage Time: Shows the number of hours the light has been used. • 3D Format: Shows the current 3D mode. • Firmware Version: Shows the firmware version of your projector. • Service Code: Shows the service code of your projector.
---------------------------	---

Maintenance

Care of the projector

Cleaning the lens

Clean the lens whenever you notice dirt or dust on the surface. Please be sure to turn off the projector and let it cool down completely before cleaning the lens.

- Use a canister of compressed air to remove dust.
- If there is dirt or smears, use lens-cleaning paper or moisten a soft cloth with lens cleaner and gently wipe the lens surface.
- Never use any type of abrasive pad, alkaline/acid cleaner, scouring powder, or volatile solvent, such as alcohol, benzene, thinner or insecticide. Using such materials or maintaining prolonged contact with rubber or vinyl materials may result in damage to the projector surface and cabinet material.

Cleaning the projector case

Before you clean the case, turn the projector off using the proper shutdown procedure as described in [Shutting down the projector on page 24](#) and unplug the power cord.

- To remove dirt or dust, wipe the case with a soft, lint-free cloth.
- To remove stubborn dirt or stains, moisten a soft cloth with water and a neutral pH detergent. Then wipe the case.



Never use wax, alcohol, benzene, thinner or other chemical detergents. These can damage the case.

Storing the projector

If you need to store the projector for an extended time, please follow the instructions below:

- Make sure the temperature and humidity of the storage area are within the recommended range for the projector. Please refer to [Specifications on page 45](#) or consult your dealer about the range.
- Retract the adjuster feet.
- Remove the battery from the remote control.
- Pack the projector in its original packing or equivalent.

Transporting the projector

It is recommended that you ship the projector with its original packing or equivalent.

Lamp information

Getting to know the lamp hour

When the projector is in operation, the duration (in hours) of lamp usage is automatically calculated by the built-in timer. The method of calculating the equivalent lamp hour is as follows:

1. Light Usage Time = (x+y+z+a) hours, if:

Time used in **Normal** mode = x hours

Time used in **Economic** mode = y hours

Time used in **SmartEco** mode = z hours

Time used in **LampSave** mode = a hours

2. Equivalent Lamp Hour = α hours

$$\alpha = \frac{A'}{X} \times x + \frac{A'}{Y} \times y + \frac{A'}{Z} \times z + \frac{A'}{A} \times a, \text{ if}$$

X= lamp life spec of **Normal** mode

Y= lamp life spec of **Economic** mode

Z= lamp life spec of **SmartEco** mode

A= lamp life spec of **LampSave** mode

A' is the longest lamp life spec among X, Y, Z, A



When you calculate Equivalent Light Usage hour manually, it will probably have deviation from the value shown in OSD menu since projector system calculates time used for each light mode in "Minutes" then rounds down to an integer in hours shown in OSD.



For time used in each light mode shown in OSD menu:

- Time used is accumulated and rounded down to an integer in **hours**.

- When time used is less than 1 hour, it shows 0 hours.

To obtain the lamp hour information:

1. Go to **Advanced Menu - System Setup : Advanced > Light Settings** and press **OK**. The **Light Settings** page appears.
2. Press **▼** to select **Light Usage Time** and press **OK**. The **Light Usage Time** information is displayed.

You can also get the **Light Usage Time** information on the **Information** menu.

Extending lamp life

• Setting the **Light Mode**

Go to **Advanced Menu - Picture > Advanced > Light Mode**, press **OK**. The **Light Mode** page appears.

Setting the projector in **Economic, SmartEco** or **LampSave** mode extends lamp life.

Light Mode	Description
Normal	Provides full lamp brightness
Economic	Lowers brightness to extend the lamp life and decreases the fan noise
SmartEco	Adjusts the lamp power automatically depending on the content brightness level while optimizing display quality
LampSave	Adjusts the lamp power automatically depending on the content brightness level while offering a longer lamp life

• Setting **Auto Power Off**

This function allows the projector to turn off automatically if no input signal is detected after a set period of time to prevent unnecessary waste of lamp life.

To set **Auto Power Off**, go to **Advanced Menu - System Setup : Basic > Auto Off** and press **◀/▶**.

Timing of replacing the lamp (FOR SERVICE PERSONNEL ONLY)

When the **LIGHT indicator** lights up or a message appears suggesting it is time to replace the lamp, please consult your dealer or go to <http://www.BenQ.com> before installing a new lamp. An old lamp may cause a malfunction in the projector and in some instances the light may explode.



- The apparent brightness of the projected image will vary depending on the ambient lighting conditions, selected input signal contrast/brightness settings, and is directly proportional to projection distance.
- The lamp brightness will decline over time and may vary within the lamp manufacturers specifications. This is normal and expected behavior.
- The **LIGHT indicator light** and **TEMPerature warning light** will light up if the lamp becomes too hot. Turn the power off and let the projector cool for 45 minutes. If the Light or Temp indicator still lights up after turning the power back on, please contact your dealer. See [Indicators on page 43](#).

The following Lamp warning displays will remind you to change the lamp.



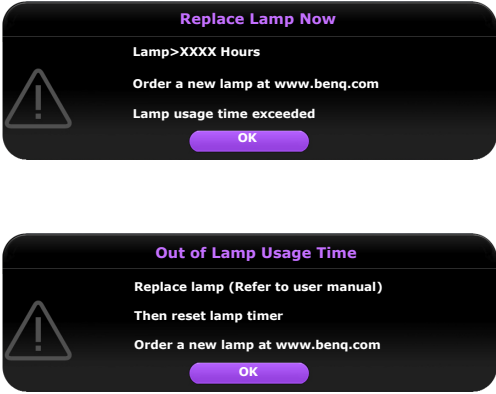















































	<p>Install a new lamp for optimal performance. Press OK to dismiss the message.</p>
	<p>It is strongly recommended that you replace the lamp at this age. The lamp is a consumable item. The lamp brightness diminishes with use. This is normal lamp behavior. You can replace the lamp whenever you notice that the brightness level has significantly diminished. Press OK to dismiss the message.</p>









	<p>The lamp MUST be replaced before the projector will operate normally. Press OK to dismiss the message.</p>
---	---



"XXXX" shown in the above messages are numbers that vary depending on different models.

Indicators

Light			Status & Description
POWER ○	TEMP ○	LIGHT ○	
Power events			
			Stand-by mode
			Powering up
			Normal operation
			Normal power-down cooling
			Download
			CW start fail
			Lamp life exhausted
			Lamp door is not closed
Burn-In events			
			Burn-in ON
			Burn-in OFF
Lamp events			
			Lamp error in normal operation
			Lamp is not lit up
Thermal events			
			Fan 1 error (the actual fan speed is outside the desired speed)
			Fan 2 error (the actual fan speed is outside the desired speed)
			Fan 3 error (the actual fan speed is outside the desired speed)
			Temperature 1 error (over limited temperature)
			Thermal IC #12C connection error

	 : Off	 : Orange On	 : Green On	 : Red On
		 : Orange Flashing	 : Green Flashing	 : Red Flashing

Troubleshooting

? The projector does not turn on.

Cause	Remedy
There is no power from the power cord.	Plug the power cord into the AC power jack on the projector, and plug the power cord into the power outlet. If the power outlet has a switch, make sure that it is switched on.
Attempting to turn the projector on again during the cooling process.	Wait until the cooling down process has completed.

? No picture

Cause	Remedy
The video source is not turned on or connected correctly.	Turn the video source on and check that the signal cable is connected correctly.
The projector is not correctly connected to the input signal device.	Check the connection.
The input signal has not been correctly selected.	Select the correct input signal with the SOURCE key.
The lens cover is still closed.	Open the lens cover.

? Blurred image

Cause	Remedy
The projection lens is not correctly focused.	Adjust the focus of the lens using the focus ring.
The projector and the screen are not aligned properly.	Adjust the projection angle and direction as well as the height of the projector if necessary.
The lens cover is still closed.	Open the lens cover.

? Remote control does not work.

Cause	Remedy
The batteries are out of power.	Replace both of the batteries with new ones.
There is an obstacle between the remote control and the projector.	Remove the obstacle.
You are too far away from the projector.	Stand within 8 meters (26 feet) of the projector.

? The password is incorrect.

Cause	Remedy
You do not remember the password.	See Entering the password recall procedure on page 23 .

Specifications

Projector specifications



All specifications are subject to change without notice.

Optical

Resolution

1920 x 1080 FHD

Display system

1-CHIP DMD

Lens

F = 2.0 ~ 2.05, f = 15.843 ~ 17.445 mm

Lamp

245 W lamp

Electrical

Power supply

AC100–240V, 3.8 A, 50–60 Hz (Automatic)

Power consumption

340 W (Max); < 0.5 W (Standby)

Mechanical

Weight

2.79 Kg (6.1 lbs)

Output terminals

Speaker

10 watt x 1

Audio signal output

Audio jack x 1

Control

USB

Type-A power supply 5V / 1.5 A x 1

RS-232 serial control

9 pin x 1

IR receiver x 2

Input terminals

Video signal input

SD/HDTV signal input

Digital - HDMI 1/MHL x 1

HDMI 2 x 1

Audio signal input

Audio in

Audio jack x 1

Environmental Requirements

Operating temperature

0°C–40°C at sea level

Operating relative humidity

10%–90% (without condensation)

Operating altitude

0–1499 m at 0°C–35°C

1500–3000 m at 0°C–30°C (with

High Altitude Mode on)

Storage temperature

-20°C–60°C at sea level

Storage humidity

10%–90% RH (without condensation)

Storage altitude

30°C@ 0~12,200m above sea level

Transporting

Original packing or equivalent is recommended

Repairing

Please visit below website and choose your country to find your service contact window.

<http://www.benq.com/welcome>

Dimensions

312 mm (W) x 225 mm (D) x 110 mm (H)

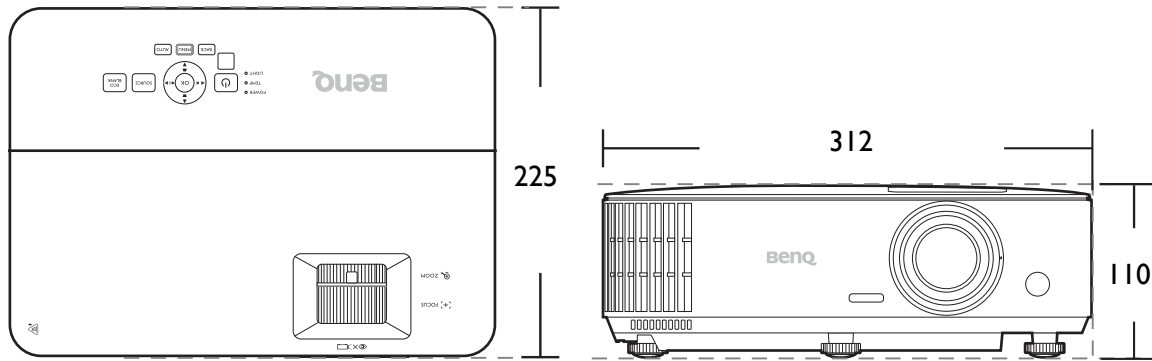

Unit: mm

Timing chart

Supported timing for HDMI (HDCP) input

- PC timings

Resolution	Mode	Vertical Frequency (Hz)	Horizontal Frequency (kHz)	Pixel Frequency (MHz)	Supported 3D format		
					Frame Sequential	Top Bottom	Side-by-Side
640 x 480	VGA_60	59.940	31.469	25.175	V	V	V
	VGA_72	72.809	37.861	31.500			
	VGA_75	75.000	37.500	31.500			
	VGA_85	85.008	43.269	36.000			
720 x 400	720 x 400_70	70.087	31.469	28.3221			
800 x 600	SVGA_60	60.317	37.879	40.000	V	V	V
	SVGA_72	72.188	48.077	50.000			
	SVGA_75	75.000	46.875	49.500			
	SVGA_85	85.061	53.674	56.250			
	SVGA_120 (Reduce Blanking)	119.854	77.425	83.000	V		
1024 x 768	XGA_60	60.004	48.363	65.000	V	V	V
	XGA_70	70.069	56.476	75.000			
	XGA_75	75.029	60.023	78.750			
	XGA_85	84.997	68.667	94.500			
	XGA_120 (Reduce Blanking)	119.989	97.551	115.5	V		
1152 x 864	1152 x 864_75	75	67.5	108			
1024 x 576@60Hz	BenQ Notebook Timing	60.00	35.820	46.996			
1024 x 600@65Hz	BenQ Notebook Timing	64.995	41.467	51.419			
1280 x 720	1280 x 720_60	60	45.000	74.250	V	V	V
1280 x 768	1280 x 768_60	59.870	47.776	79.5	V	V	V
1280 x 800	WXGA_60	59.810	49.702	83.500	V	V	V
	WXGA_75	74.934	62.795	106.500			
	WXGA_85	84.880	71.554	122.500			
	WXGA_120 (Reduce Blanking)	119.909	101.563	146.25	V		
1280 x 1024	SXGA_60	60.020	63.981	108.000		V	V
	SXGA_75	75.025	79.976	135.000			
	SXGA_85	85.024	91.146	157.500			
1280 x 960	1280 x 960_60	60.000	60.000	108		V	V
	1280 x 960_85	85.002	85.938	148.500			
1360 x 768	1360 x 768_60	60.015	47.712	85.500		V	V
1440 x 900	WXGA+_60	59.887	55.935	106.500		V	V
1400 x 1050	SXGA+_60	59.978	65.317	121.750		V	V
1600 x 1200	UXGA	60.000	75.000	162.000		V	
1680 x 1050	1680 x 1050_60	59.954	65.290	146.250		V	V
640 x 480@67Hz	MAC13	66.667	35.000	30.240			
832 x 624@75Hz	MAC16	74.546	49.722	57.280			
1024 x 768@75Hz	MAC19	75.020	60.241	80.000			
1152 x 870@75Hz	MAC21	75.06	68.68	100.00			
1920 x 1080@60Hz	1920 x 1080_60	60	67.5	148.5		V	V
1920 x 1200@60Hz	1920 x 1200_60 (Reduce Blanking)	59.95	74.038	154		V	V



The timings showing above may not be supported due to EDID file and VGA graphic card limitations. It is possible that some timings cannot be chosen.

• Video timings

Timing	Resolution	Vertical Frequency (Hz)	Horizontal Frequency (kHz)	Pixel Frequency (MHz)	Supported 3D format			
					Frame Sequential	Frame Packing	Top Bottom	Side-by-Side
480i	720 x 480	59.94	15.73	27	V			
480p	720 x 480	59.94	31.47	27	V			
576i	720 x 576	50	15.63	27				
576p	720 x 576	50	31.25	27				
720/50p	1280 x 720	50	37.5	74.25		V	V	V
720/60p	1280 x 720	60	45.00	74.25	V	V	V	V
1080/50i	1920 x 1080	50	28.13	74.25				V
1080/60i	1920 x 1080	60	33.75	74.25				V
1080/24P	1920 x 1080	24	27	74.25		V	V	V
1080/25P	1920 x 1080	25	28.13	74.25				
1080/30P	1920 x 1080	30	33.75	74.25				
1080/50P	1920 x 1080	50	56.25	148.5			V	V
1080/60P	1920 x 1080	60	67.5	148.5			V	V

Supported timing for MHL input

Timing	Resolution	Vertical Frequency (Hz)	Horizontal Frequency (kHz)	Pixel Frequency (MHz)
480i	720 (1440) x 480	59.94	15.73	27
480p	720 x 480	59.94	31.47	27
576i	720 (1440) x 576	50	15.63	27
576p	720 x 576	50	31.25	27
720/50p	1280 x 720	50	37.5	74.25
720/60p	1280 x 720	60	45.00	74.25
1080/24P	1920 x 1080	24	27	74.25
1080/25P	1920 x 1080	25	28.13	74.25
1080/30P	1920 x 1080	30	33.75	74.25
1080/50i	1920 x 1080	50	28.13	74.25
1080/60i	1920 x 1080	60	33.75	74.25
1080/50p	1920 x 1080	50	56.25	148.5
1080/60p	1920 x 1080	60	67.5	148.5

RS232 command

RS232 pin assignment

No.	Serial
1	NC
2	RX
3	TX
4	NC
5	GND

No.	Serial
6	NC
7	RTSZ
8	CTSZ
9	NC

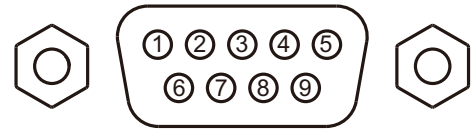

Function	Type	Operation	ASCII
Power	Write	Power On	<CR>*pow=on#<CR>
	Write	Power off	<CR>*pow=off#<CR>
	Read	Power Status	<CR>*pow=?#<CR>
Source Selection	Write	HDMI(MHL)	<CR>*sour=hdmi#<CR>
	Write	HDMI 2	<CR>*sour=hdmi2#<CR>
	Read	Current source	<CR>*sour=?#<CR>
Audio Control	Write	Mute On	<CR>*mute=on#<CR>
	Write	Mute Off	<CR>*mute=off#<CR>
	Read	Mute Status	<CR>*mute=?#<CR>
	Write	Volume +	<CR>*vol=+#<CR>
	Write	Volume -	<CR>*vol=-#<CR>
	Write	Volume level for customer	<CR>*vol=value#<CR>
	Read	Volume Status	<CR>*vol=?#<CR>
Picture Mode	Write	Bright	<CR>*appmod=bright#<CR>
	Write	Living Room	<CR>*appmod=livingroom#<CR>
	Write	Game	<CR>*appmod=game#<CR>
	Write	Cinema	<CR>*appmod=cine#<CR>
	Write	Football	<CR>*appmod=football#<CR>
	Write	User1	<CR>*appmod=user1#<CR>
	Write	User2	<CR>*appmod=user2#<CR>
	Write	3D	<CR>*appmod=threed#<CR>
Read	Picture Mode	<CR>*appmod=?#<CR>	

Function	Type	Operation	ASCII
Picture Setting	Write	Contrast +	<CR>*con=+#<CR>
	Write	Contrast -	<CR>*con=-#<CR>
	Write	Set Contrast value	<CR>*con=value#<CR>
	Read	Contrast value	<CR>*con=?#<CR>
	Write	Brightness +	<CR>*bri=+#<CR>
	Write	Brightness -	<CR>*bri=-#<CR>
	Write	Set Brightness value	<CR>*bri=value#<CR>
	Read	Brightness value	<CR>*bri=?#<CR>
	Write	Sharpness +	<CR>*sharp=+#<CR>
	Write	Sharpness -	<CR>*sharp=-#<CR>
	Write	Set Sharpness value	<CR>*sharp=value#<CR>
	Read	Sharpness value	<CR>*sharp=?#<CR>
	Write	Color Temperature-Warm	<CR>*ct=warm#<CR>
	Write	Color Temperature-Normal	<CR>*ct=normal#<CR>
	Write	Color Temperature-Cool	<CR>*ct=cool#<CR>
	Write	Color Temperature-lamp native	<CR>*ct=native#<CR>
	Read	Color Temperature Status	<CR>*ct=?#<CR>
	Write	Aspect 4:3	<CR>*asp=4:3#<CR>
	Write	Aspect 16:9	<CR>*asp=16:9#<CR>
	Write	Aspect 16:10	<CR>*asp=16:10#<CR>
	Write	Aspect Auto	<CR>*asp=AUTO#<CR>
	Write	Aspect Real	<CR>*asp=REAL#<CR>
	Read	Aspect Status	<CR>*asp=?#<CR>
	Write	Vertical Keystone +	<CR>*vkeystone=+#<CR>
	Write	Vertical Keystone -	<CR>*vkeystone=-#<CR>
	Read	Vertical Keystone value	<CR>*vkeystone=?#<CR>
	Write	Overscan Adjustment +	<CR>*overscan=+#<CR>
	Write	Overscan Adjustment -	<CR>*overscan=-#<CR>
	Read	Overscan Adjustment value	<CR>*overscan=?#<CR>
	Operation Settings	Write	Brilliant color on
Write		Brilliant color off	<CR>*BC=off#<CR>
Read		Brilliant color status	<CR>*BC=?#<CR>
Write		Reset picture settings	<CR>*rstpicsetting#<CR>
Write		Projector Position-Front Table	<CR>*pp=FT#<CR>
Write		Projector Position-Rear Table	<CR>*pp=RE#<CR>
Write		Projector Position-Rear Ceiling	<CR>*pp=RC#<CR>
Write		Projector Position-Front Ceiling	<CR>*pp=FC#<CR>
Read		Projector Position Status	<CR>*pp=?#<CR>
Write		Quick cooling on	<CR>*qcool=on#<CR>
Write		Quick cooling off	<CR>*qcool=off#<CR>
Read		Quick cooling status	<CR>*qcool=?#<CR>
Write		Quick auto search	<CR>*QAS=on#<CR>
Write		Quick auto search	<CR>*QAS=off#<CR>
Read		Quick auto search status	<CR>*QAS=?#<CR>
Write		Menu Position - Center	<CR>*menuposition=center#<CR>
Write		Menu Position - Top-Left	<CR>*menuposition=tl#<CR>
Write		Menu Position - Top-Right	<CR>*menuposition=tr#<CR>
Write		Menu Position - Bottom-Right	<CR>*menuposition=br#<CR>
Write		Menu Position - Bottom-Left	<CR>*menuposition=bl#<CR>
Read		Menu Position Status	<CR>*menuposition=?#<CR>
Write		Direct Power On-on	<CR>*directpower=on#<CR>
Write		Direct Power On-off	<CR>*directpower=off#<CR>
Read		Direct Power On-Status	<CR>*directpower=?#<CR>

Function	Type	Operation	ASCII
Baud Rate	Write	9600	<CR>*baud=9600#<CR>
	Write	14400	<CR>*baud=14400#<CR>
	Write	19200	<CR>*baud=19200#<CR>
	Write	38400	<CR>*baud=38400#<CR>
	Write	57600	<CR>*baud=57600#<CR>
	Write	115200	<CR>*baud=115200#<CR>
	Read	Current Baud Rate	<CR>*baud=?#<CR>
Lamp Control	Read	Lamp	<CR>*ltim=?#<CR>
	Write	Normal mode	<CR>*lampm=lnor#<CR>
	Write	Eco mode	<CR>*lampm=eco#<CR>
	Write	SmartEco mode	<CR>*lampm=seco#<CR>
	Write	SmartEco mode 2	<CR>*lampm=seco2#<CR>
	Read	Lamp Mode Status	<CR>*lampm=?#<CR>
Miscellaneous	Read	Model Name	<CR>*modelname=?#<CR>
	Read	System F/W Version	<CR>*sysfwversion=?#<CR>
	Read	Scaler F/W Version	<CR>*scalerfwversion=?#<CR>
	Read	MCU F/W Version	<CR>*mcufwversion=?#<CR>
	Read	Ballast F/W Version	<CR>*ballastfwversion=?#<CR>
	Write	Blank On	<CR>*blank=on#<CR>
	Write	Blank Off	<CR>*blank=off#<CR>
	Read	Blank Status	<CR>*blank=?#<CR>
	Write	Menu On	<CR>*menu=on#<CR>
	Write	Menu Off	<CR>*menu=off#<CR>
	Read	Menu Status	<CR>*menu=?#<CR>
	Write	Up	<CR>*up#<CR>
	Write	Down	<CR>*down#<CR>
	Write	Right	<CR>*right#<CR>
	Write	Left	<CR>*left#<CR>
	Write	Enter	<CR>*enter#<CR>
	Write	Back	<CR>*back#<CR>
	Write	Source Menu On	<CR>*sourmenu=on#<CR>
	Write	Source Menu Off	<CR>*sourmenu=off#<CR>
	Read	Source Menu Status	<CR>*sourmenu=?#<CR>
	Write	3D Sync Off	<CR>*3d=off#<CR>
	Write	3D Auto	<CR>*3d=auto#<CR>
	Write	3D Sync Top Bottom	<CR>*3d=tb#<CR>
	Write	3D Sync Frame Sequential	<CR>*3d=fs#<CR>
	Write	3D Frame packing	<CR>*3d=fp#<CR>
	Write	3D Side by side	<CR>*3d=sbs#<CR>
	Write	3D inverter disable	<CR>*3d=da#<CR>
	Write	3D inverter	<CR>*3d=iv#<CR>
Read	3D Sync Status	<CR>*3d=?#<CR>	