



WDCI0C
InstaShow™
User Manual



Copyright

Copyright © 2019 by BenQ Corporation. All rights reserved. No part of this publication may be reproduced, transmitted, transcribed, stored in a retrieval system or translated into any language or computer language, in any form or by any means, electronic, mechanical, magnetic, optical, chemical, manual or otherwise, without the prior written permission of BenQ Corporation.

Disclaimer

BenQ Corporation makes no representations or warranties, either expressed or implied, with respect to the contents hereof and specifically disclaims any warranties, merchantability or fitness for any particular purpose. Further, BenQ Corporation reserves the right to revise this publication and to make changes from time to time in the contents hereof without obligation of BenQ Corporation to notify any person of such revision or changes.

This user manual aims to provide the most updated and accurate information to customers, and thus all contents may be modified from time to time without prior notice. Please visit www.benq.com for the latest version of this manual.

The illustrations and the images in this guide are for your reference.

BenQ ecoFACTS

BenQ has been dedicated to the design and development of greener product as part of its aspiration to realize the ideal of the “Bringing Enjoyment 'N Quality to Life” corporate vision with the ultimate goal to achieve a low-carbon society. Besides meeting international regulatory requirement and standards pertaining to environmental management, BenQ has spared no efforts in pushing our initiatives further to incorporate life cycle design in the aspects of material selection, manufacturing, packaging, transportation, using and disposal of the products. BenQ ecoFACTS label lists key eco-friendly design highlights of each product, hoping to ensure that consumers make informed green choices at purchase. Check out BenQ's CSR Website at <http://csr.BenQ.com/> for more details on BenQ's environmental commitments and achievements.



Table of contents

Copyright	2
Disclaimer	2
BenQ ecoFACTS	2
Introduction	5
Product features	5
Package content	6
Product specification	7
Overview	8
InstaShow Button	8
InstaShow Host	8
LED indicators of the InstaShow Button and InstaShow Host	9
Installation	10
Environment check	10
Assembling the InstaShow Host	11
Setting up the InstaShow Host	11
Attaching the InstaShow Host to the ceiling	11
Attaching the InstaShow Host to a ceiling mount	11
Placing the InstaShow Host on a table	12
Installing the InstaShow Host on the wall or trolley	14
Positioning the InstaShow Host antennas	15
For ceiling installation	15
For ceiling mount installation	15
For table placement	16
Connecting the HDMI cable and power	16
Assembling the adapter	17
Connecting the HDMI cable.....	18
Power supply via a USB type A jack (5V/1.5A)	18
Power supply via a power adapter.....	19
LAN connection	19
Setting up and powering an InstaShow Button	19
Pairing a InstaShow Button and InstaShow Host	22
When the InstaShow Host is placed on a table	22
Waking up the InstaShow Host	25
Storing InstaShow Buttons in the cradle	25
Resetting a InstaShow Host	25
Resetting a InstaShow Button	26
Starting and stopping presentations	29
Getting ready	29
Starting presentation	29
Idle presentation	31
Play video with InstaShow™	32
Web management	34
Accessing the web management interface	34
Logging into the web management interface via direct connection	34
Logging into the web management interface via LAN.....	36
Logging into the web management interface via a wireless network.....	37
Getting started	38
Top command buttons	38

Main column	39
Function bar	40
WAN	41
Wireless Network	42
Pairing	46
Advance Setting	49
Scheduling	55
Tool	56
Legal Announcement	62
Troubleshooting	63

Introduction

InstaShow™ is a wireless device for corporate meeting rooms. Users expect devices to respond instantly, apps to launch and to control at their fingertips, and information to be available on demand. InstaShow™ bypasses the complicated steps of IP addresses, driver installation, app execution, setting selection, etc. to quickly deliver professional, stable visual quality for teams to collaborate freely and confidently. InstaShow™ is an unique all-hardware solution without software issues for universal compatibility and display flexibility.

A standard InstaShow™ set consists of an InstaShow Host and two InstaShow Buttons. Depending on the location where you buy the product, the software of the base unit can be different. You can buy additional InstaShow Button kit if needed.



Product features

InstaShow™ is equipped with the following features:

Features	Description
True Plug & Play	Simply connect InstaShow™ into your USB-C™ port, then push the button to start presenting immediately.
No Software	InstaShow™ doesn't need any software installation or execution. There's no setup, configuration, or waiting for pop-ups to launch. Just plug into your PC or Mac and start presenting immediately.
InstaVideo	Convenient button switches between Presentation mode and Video mode for precise productivity or smooth 1080p video, only from BenQ. See Play video with InstaShow™ on page 32 for details.
Auto Channel Selection	InstaShow™ automatically selects the best wireless channel upon boot-up, ensuring smooth presentations in any environment.
Wireless 802.11ac	The latest 802.11ac Wi-Fi guarantees extremely smooth wireless streaming without lag or buffering.
Video and Audio	InstaShow™'s HDMI output supports up to 60Hz Full HD 1080p video and stereo sound without cable clutter or complicated driver selection.

Features	Description
Assured Performance	Peace of mind for consistent wireless presentation performance without relying on your PC.
Extended Desktop	Keep your presenter view, notes, and backup data on your laptop screen while presenting to the wireless screen with extended desktop in both Windows and OS X.



- Transmission distance depends on actual environment. Stated distance is based on line-of-sight measurement. Structures constructed of steel, wood, concrete, or brick may decrease transmission distance.
- According to regulatory restrictions in different regions of the world, Wi-Fi channels cannot be used in countries outside the purchased region.

Package content

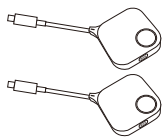

InstaShow Buttons

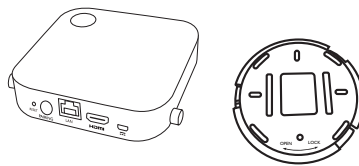

InstaShow Host and Lid

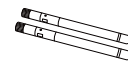

2 Antennas



Cradle



Adapter & Plugs

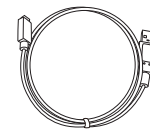

Cable: USB A(M) to Micro B(M)

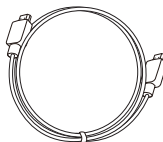

Cable: HDMI A(M) to A(M)

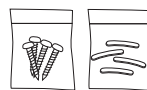

Screws & Rubber Foot

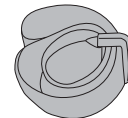

Velcro Strap

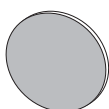

Round Double-sided sponge
Tape



Quick Start Guide



Safety Statement



- Available accessories and the pictures shown here may differ from the actual contents and the product supplied for your region.
- Use original accessories to ensure compatibility.
- Always keep the product and accessories out of reach of children.

Product specification

Feature			
Color	Black		
Video outputs	HDMI 1.4, comply with HDCP		
Frame Rate	Up to 30fps depending on environment		
Output resolution	Video Timing: 1280x720 (720P), 1920x1080 (1080p) PC Timing: 800x600, 1024x768, 1280x768, 1280x1024, 1280x960, 1360x768, 1440x900, 1400x1050, 1680x1050		
Input resolution	Up to 1920x1080		
Number of simultaneous connections	16 pcs		
Audio	Stereo, Radio quality 16bits 48KHz		
Wireless transmission protocol	IEEE 802.11ac, 5GHz, 2T2R		
Data rate wireless	Up to 400Mbps		
Frequency Band	5GHz		
Authentication protocol	WPA2 (WPAS-PSK (Pre-Shared key) / WPA2-Enterprise)		
Security (encryption)	AES 128 bit		
Support platform	Windows, MAC, Chrome. Any OS supports HDMI standard 1.4		
Reach	Max. 8M between the InstaShow Button and the InstaShow Host		
Temperature range	Operating: 0°C to +40°C (+32°F to +104°F)		
	Storage: -10°C to +60°C (+14°F to +140°F)		
Humidity	Storage: 5% to 90% relative humidity, non-condensing		
	Operation: 10% to 80% relative humidity, non-condensing		
InstaShow Button			
Cable	USB-C™	Power supply	DC 5V±10%, 0.9A
Reset button	x1	Power consumption	Normal: 4.5W
Mode key	x1	Dimension	84.5x189.55x19.9mm
LED	Red (boosting), Green (Wi-Fi connected), Blue (presenting)	Weight	95g
InstaShow Host			
Power button	x1	Power supply	DC 5V±10%, 1.5A
Pairing key	x1	Power consumption	Normal: 5W
LAN	x1 (10/100 Mbps)		Network standby: 2W
Video output	x1 HDMI 1.4 (video and audio)		HDMI standby: 0.02W
DC Power Jack	x1 (micro USB)	Dimension (WxHxD) (not including rubber feet)	110x110x27mm (99mm with antenna)
LED	Red (boosting), Green (ready for connection), Blue (presenting)	Weight (include antenna)	150g
Cradle			
Dimension	85x97.5x170.4mm	Weight	630g

Overview

InstaShow Button

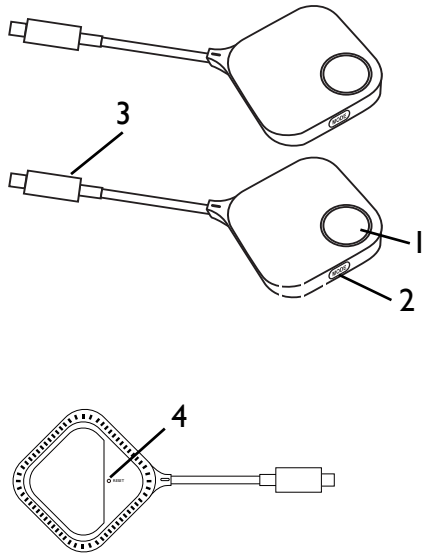

1. **Present key with LED indicator**

Press to start or stop presenting. Refer to [LED indicators of the InstaShow Button and InstaShow Host on page 9](#) for more information.

2. **MODE key**

Press to pair with an InstaShow Host or to switch to Video/Present mode.

3. **USB-C™ connector**

Connect to a computer or laptop.

4. **RESET**

Poke the **RESET** hole to reset the device if the device stops responding. Refer to [Resetting a InstaShow Host on page 25](#) for more information.

InstaShow Host

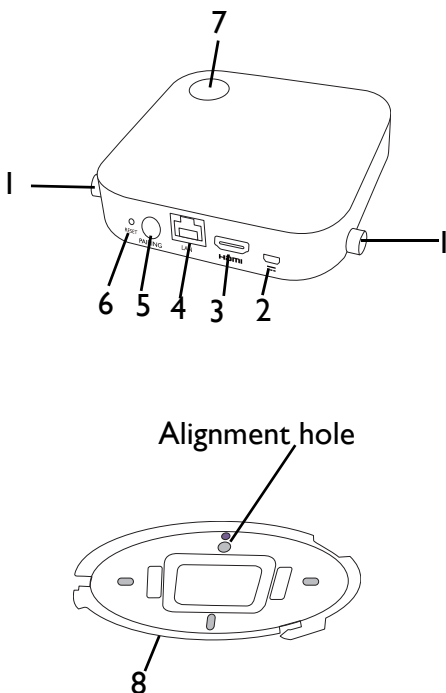

1. **Fixture parts for the Antennas**

Refer to [Assembling the InstaShow Host on page 11](#) for more information.

2. **DC 1.5A port**

Connect to an adapter or a display using a Cable USB A(M) to Micro B(M).

3. **HDMI port**

Connect to a display using a Cable HDMI A(M) to A(M).

4. **LAN port**

Allows users access to the web management interface through a direct or network connection.

5. **PAIRING key**

Press to pair with an InstaShow Button.

6. **RESET**

Poke the **RESET** hole to reset the device if the device stops responding. Refer to [Resetting a InstaShow Button on page 26](#) for more information.

7. **Power button with LED indicator**

Press to turn the InstaShow Host on and off.

8. **Lid of InstaShow Host**

Refer to [Attaching the InstaShow Host to the ceiling on page 11](#) for more information.

LED indicators of the InstaShow Button and InstaShow Host

Please refer to the tables below for detailed indicator and status descriptions for the InstaShow Button and InstaShow Host.

LED indicator on the InstaShow Button	Status Description
Static blue	The device is presenting.
Flashing blue	The device is in pairing state for 10 seconds.
Flashing green	The device is upgrading the firmware.
Static green	The device is connected and working normally.
Flashing red	The device is trying to connect to an InstaShow Host or encountering a problem.
Static red	The device is starting up.
Off	The device is powered off.
Quick flashing red	The reset process is triggered.

LED indicator on the InstaShow Host	Status Description
Static blue	Connected device is presenting.
Flashing blue	The device is in pairing state for 2 minutes.
Flashing green	The device is upgrading the firmware.
50% static green	The device is in network standby mode.
Static green	The device is on and ready for connection.
Flashing red	The device is encountering a problem.
Static red	The device is starting up.
Off	The device is powered off.
Quick flashing red	The reset process is triggered.

Installation

This section will guide you on how to prepare the unit before its initial use.

Environment check

Before installing your InstaShow™ kit, check the environmental conditions.

1. Do not install the device near heat sources like radiators or direct sunlight, or in a site with excessive dust or humidity.
2. Ambient temperature conditions are listed as below. Maximum ambient temperature should be +40°C or 104°F. Minimum ambient temperature should be +0°C or 32°F. Storage temperature should be -10°C to +60°C (14°F to 140°F).
3. Humidity conditions are listed as below. For storage, the relative humidity should be 5% to 90% (non-condensing). For operation, the relative humidity should be 10% to 80% (non-condensing).

As your InstaShow™ works with different displays, the steps required to complete the installation may vary according to the actual environment and your display specifications. Follow the procedures below and refer to the specified sections for details.

1. Assemble the InstaShow Host with the antennas. See [Assembling the InstaShow Host on page 11](#) for details.
2. Connect the InstaShow Host to the display and power properly. See [Connecting the HDMI cable and power on page 16](#) for details. Four installation methods are provided.
 - Attaching the InstaShow Host to the ceiling
 - Attaching the InstaShow Host to a ceiling mount
 - Placing the InstaShow Host on a table
 - Installing the InstaShow Host on the wall or trolley
3. Connect the InstaShow Button to the desired devices and power properly. See [Setting up and powering an InstaShow Button on page 19](#) for details.
4. Make sure that all the connected devices have been powered on. Press the source button of the display and make sure that the HDMI source has been transmitted. See [Pairing a InstaShow Button and InstaShow Host on page 22](#) for details.

Assembling the InstaShow Host

Assemble the InstaShow Host with two antennas by turning the antennas clockwise (right) and counterclockwise (left) to fasten them tightly.

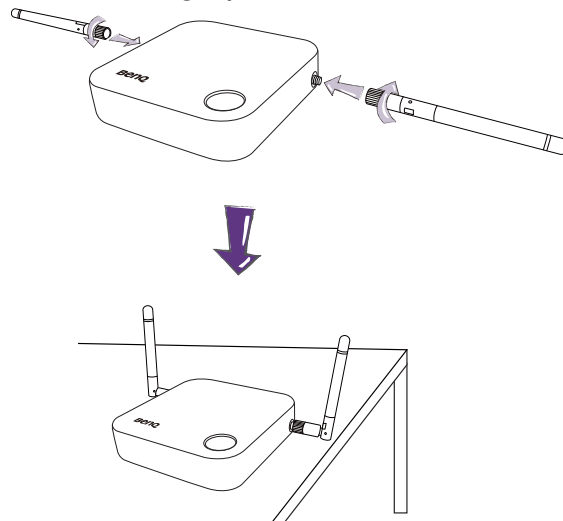

Setting up the InstaShow Host

You are provided with four different ways to position the InstaShow Host. The total weight of the InstaShow Host Unit is 150g.

Attaching the InstaShow Host to the ceiling

1. Place the lid on the ceiling and locate the alignment hole.
2. Use the screws provided to lock the lid to the ceiling.
3. Lock the first hole (1).
4. Follow the instruction in the illustration below to lock the other holes (2-4).
5. Rotate the InstaShow Host counterclockwise to affix the InstaShow Host to the lid.

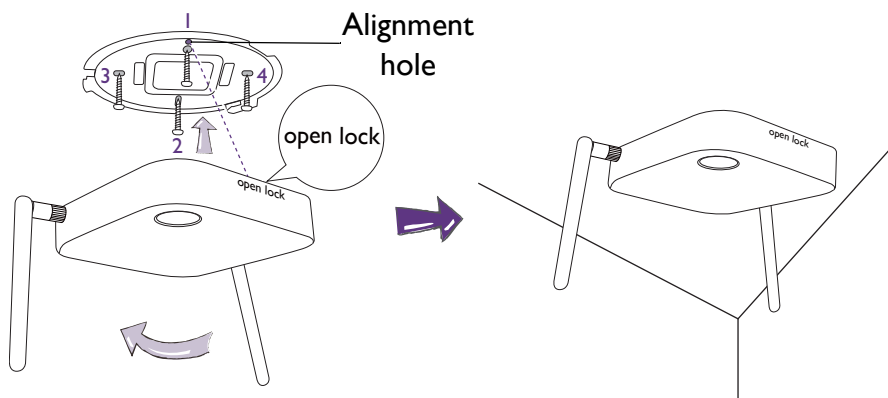

- Please only use the screws (M3*16 tapping screw) provided with the kit to mount the InstaShow Host to the ceiling.
- Please see [Positioning the InstaShow Host antennas on page 15](#) for guidelines on positioning the antenna to maximize signal reception.

Attaching the InstaShow Host to a ceiling mount

If the display is mounted on the ceiling:

1. Attach the InstaShow Host to the ceiling mount using the provided velcro strap.
2. Fix the InstaShow Host to the mounting holder.
3. Use the supplied velcro to fix the mounting holder and the InstaShow Host to the ceiling mount as shown in the illustration.

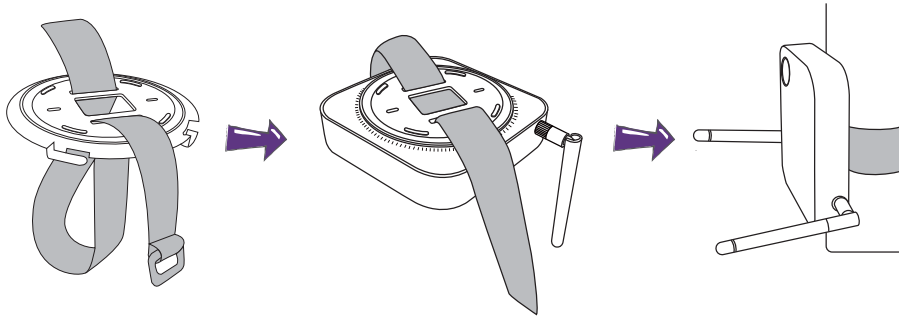

- Please only use the velcro strap (240(L)mm*25(W)mm) provided with the kit to mount the InstaShow Host to a ceiling mount.
- Please see [Positioning the InstaShow Host antennas on page 15](#) for guidelines on positioning the antenna to maximize signal reception.

Placing the InstaShow Host on a table

If your display is placed on a table, first attach the lid of to the InstaShow Host in the following the process described below:

1. Align the top of the lid over the bottom of InstaShow Host so that the alignment hole is pointed towards the “Open” text located at the front side of the InstaShow Host, then push the lid into the InstaShow Host.

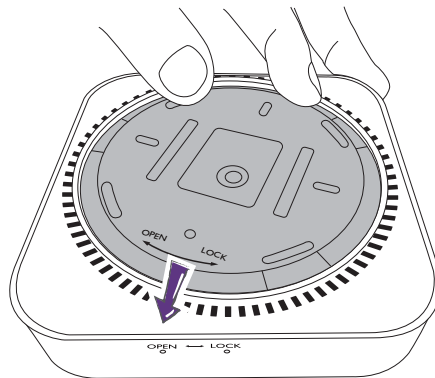

2. Follow the “Lock” arrow displayed on the lid and turn the lid counter-clockwise.

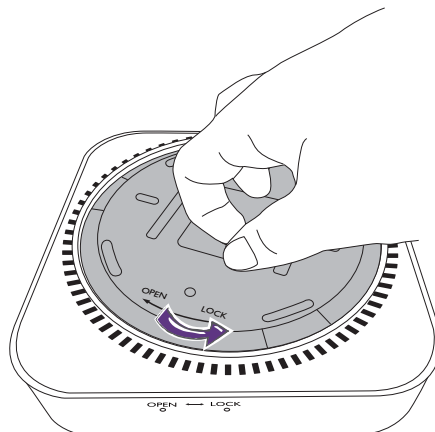

3. Turn the lid until it clicks into place.

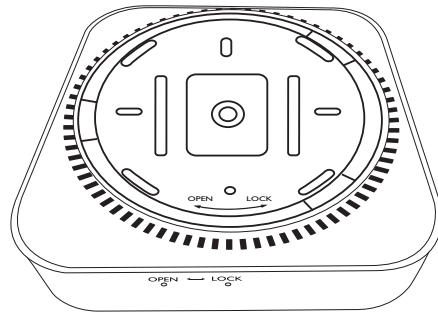

4. Attach the rubber feet to the recesses on the lid and put the InstaShow Host right next to the display.

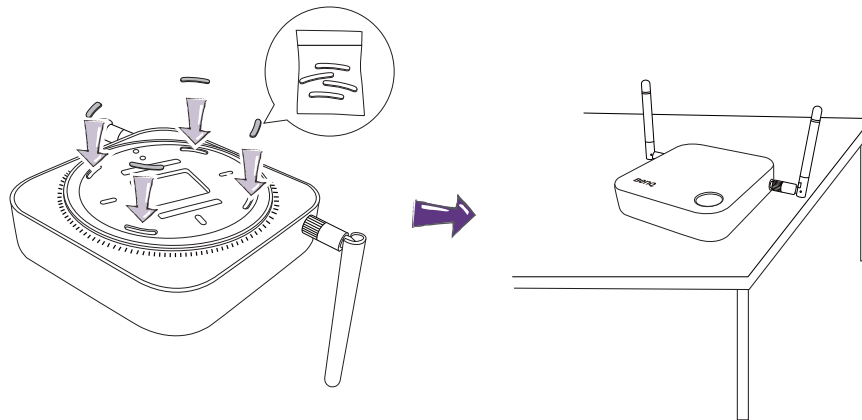

- Please only use the rubber foot provided with the kit to attach to the InstaShow Host.
- Please see [Positioning the InstaShow Host antennas on page 15](#) for guidelines on positioning the antennas to maximize signal reception.

Installing the InstaShow Host on the wall or trolley

If you need to install the InstaShow Host near a display:

1. Use the round double-sided sponge tape provided to stick to the lid of the InstaShow Host.
2. Affix the InstaShow Host on the wall near the display.
3. Keep the antennas away from any signal obstructions.

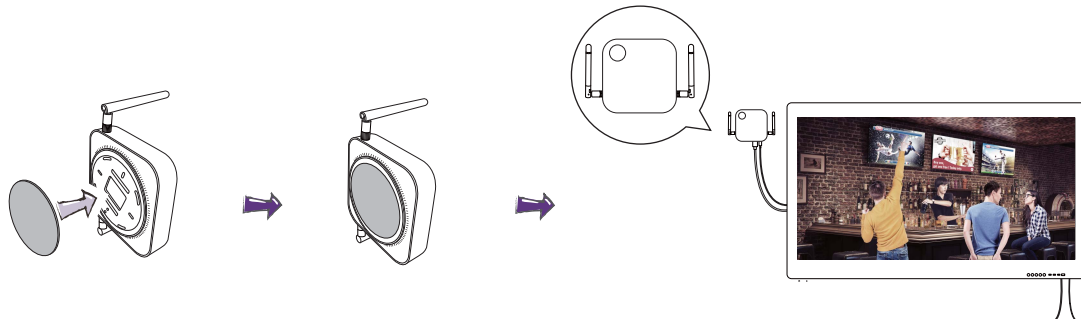

You can also place the InstaShow Host on a mobile display trolley. See the illustration.

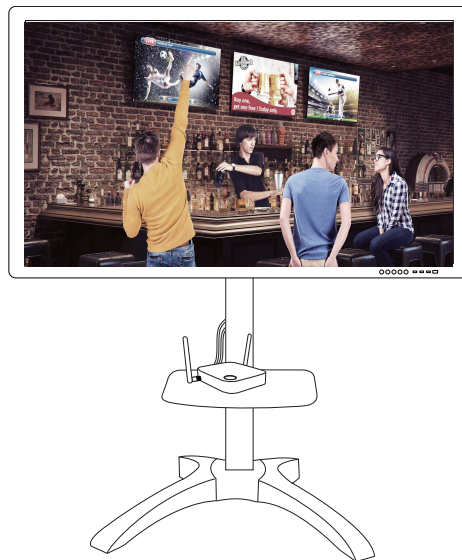

- Please only use the round double-sided sponge tape provided with the kit to stick the lid of the InstaShow Host.
- Please wait 24 hours after you attach the double-sided sponge tape to the lid of the InstaShow Host.

Positioning the InstaShow Host antennas

Once you have properly installed the InstaShow Host, follow the guidelines below to position the antennas to maximize signal reception:

For ceiling installation

Position the antennas so that they are both pointed downwards at an angle roughly perpendicular to the ceiling:

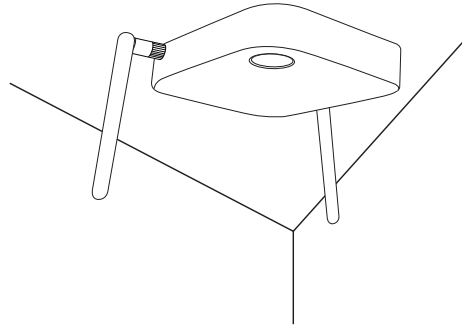

For ceiling mount installation

- Position the antennas so that they are both point either upwards or downwards roughly parallel to the ceiling mount:

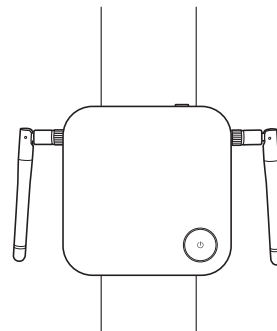
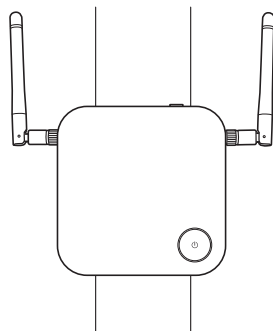

- If you encounter bad signal reception after initial use of the InstaShow Host you can manually adjust the antennas so that they tilt at a slight angle to maximize signal reception. When doing so, avoid tilting the antennas toward the ceiling mount:

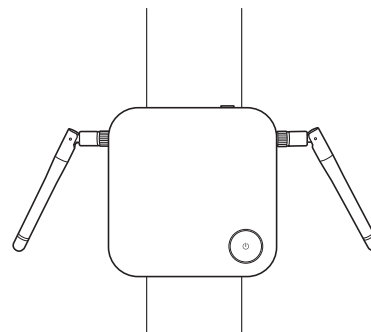
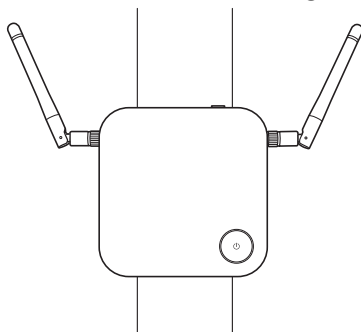

- Avoid positioning the antennas in a horizontal manner, this may result in a weak signal reception:

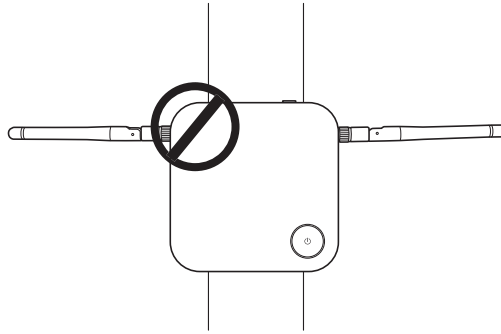

- If the InstaShow Host is attached to a metallic ceiling mount ensure that the antennas are at least 3 cm away from the metal portion of the ceiling mount:

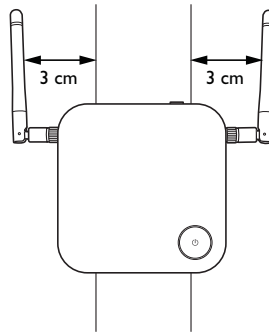

For table placement

Position the antennas so that they are both pointed upwards roughly perpendicular to the table:

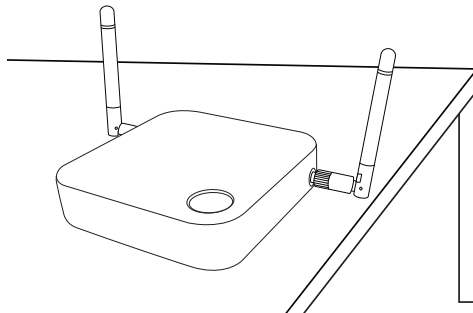

Connecting the HDMI cable and power

Once the InstaShow Host has been positioned properly near the display, connect the HDMI cable and power to ensure signal transmission.

To supply power to the InstaShow Host, do one of the following.

Assemble the adapter. See [Assembling the adapter on page 17](#) for details.

- Some BenQ projector models may be equipped with a USB type A jack (5V/1.5A) to provide power supply to the InstaShow Host. See [Power supply via a USB type A jack \(5V/1.5A\) on page 18](#) for details.
- For display models without a USB type A jack (5V/1.5A) for power supply, see [Power supply via a power adapter on page 19](#) for details.

Assembling the adapter

Every InstaShow™ adapter provided in the box includes a plug socket and plugs based on the region in which you purchased InstaShow™. Below are images of the standard American, standard European, and standard British plugs:

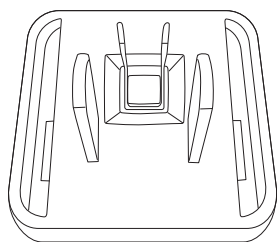

Standard American

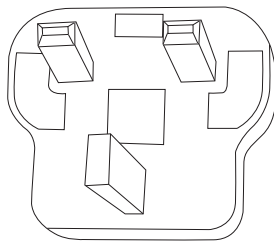

Standard British

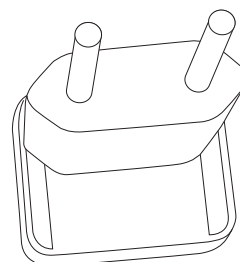

Standard European

To connect the plug of your choice, follow the steps below.

1. Align and insert the bottom hook to the adapter.
2. Close the gap by pushing the plug.
3. The adapter is successfully assembled when it clips into place.

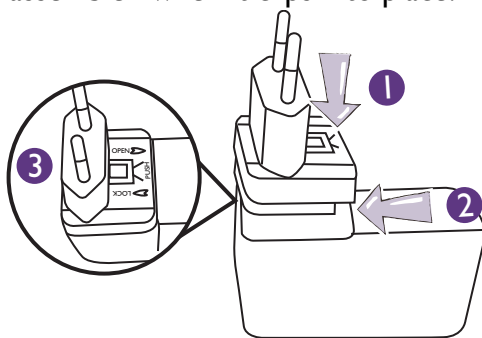

To disconnect the plug, follow the steps below.

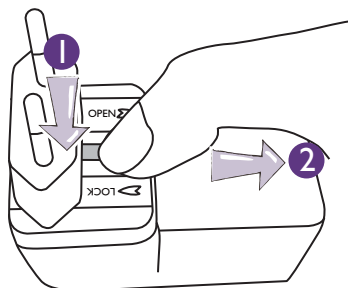

1. Push the latch in the middle.
2. Open the gap by pulling the adapter downwards.

Connecting the HDMI cable

Connect the HDMI cable to the HDMI out jack of the InstaShow Host and the HDMI input jack of the projector.

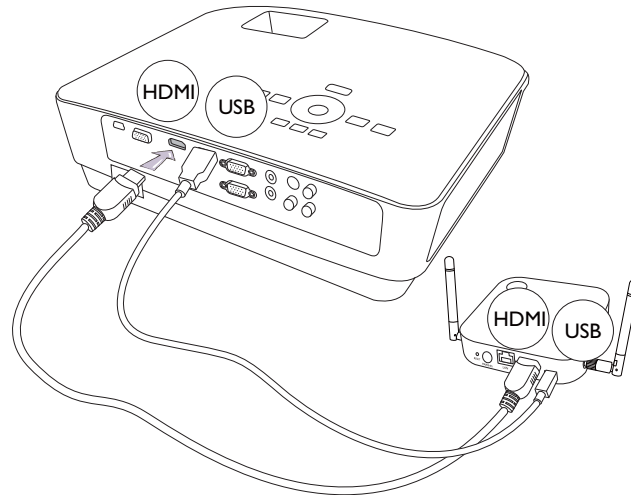

Power supply via a USB type A jack (5V/1.5A)

Connect one end of the supplied USB cable to the mini USB jack of the InstaShow Host and the other end to the USB type A jack (1.5A) of the BenQ projector. See the illustration.

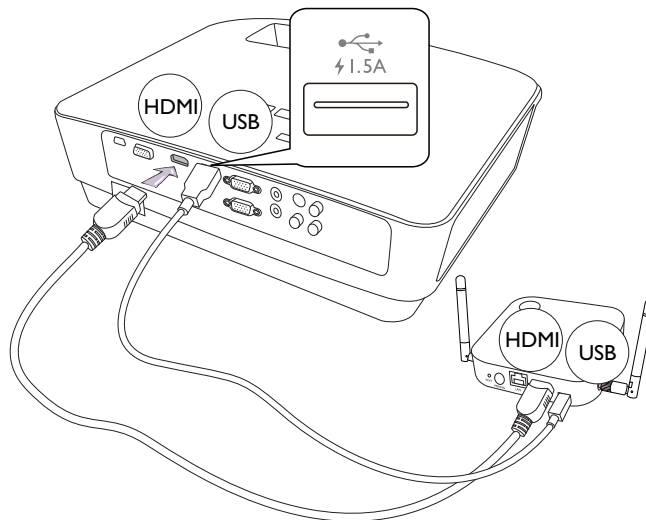

Power supply via a power adapter

Connect the supplied USB power adapter to the mini USB jack of the InstaShow Host and plug the other end into a wall socket. The LED indicator on the power button of the InstaShow Host lights up static red when the InstaShow Host is connected to the power mains.

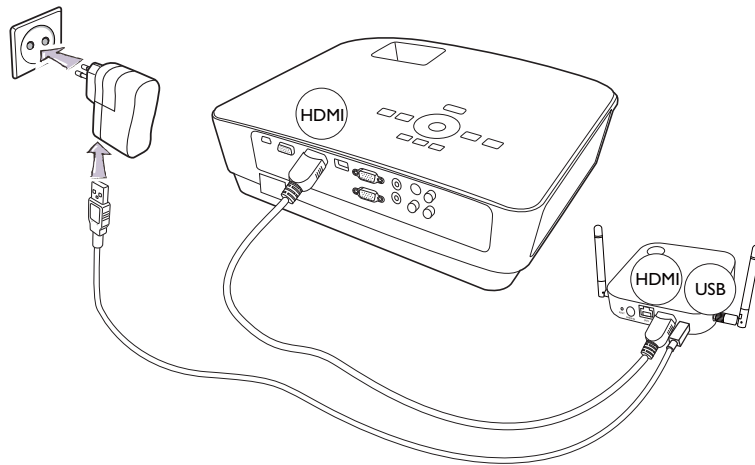

For BenQ IFP (Interactive Flat Panel) products, please have power supplied via a power adapter.

LAN connection

The InstaShow Host can be connected to a local network or directly to a laptop. The LAN connection can be used to configure your InstaShow™ and update the software. Insert a network cable with RJ-45 connectors into the LAN port and connect the other side to a LAN.

Setting up and powering an InstaShow Button



Make sure your laptop supports video output and power delivery via USB-C™ port (DisplayPort Alternate Mode on USB-C™).

1. Connect the InstaShow Button's USB-C™ jack to the corresponding input of a laptop. See the illustration.

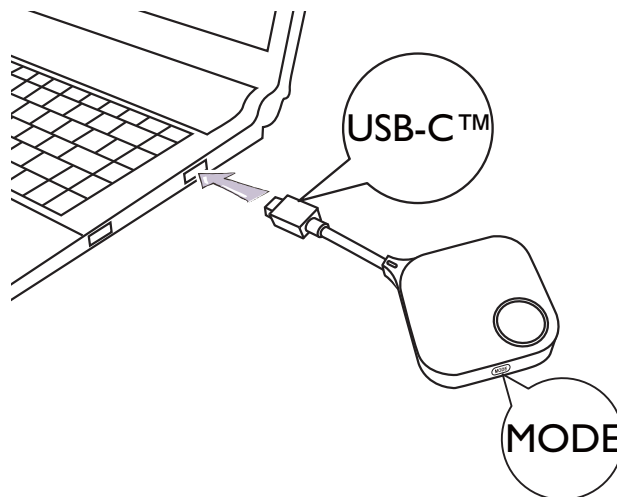

2. The LED indicator of the InstaShow Button will turn red while the InstaShow Button is starting up.

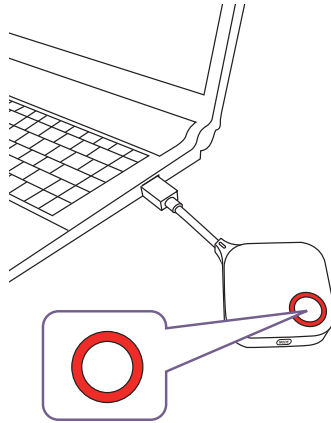

3. When the InstaShow button is ready to present, the LED indicator will turn green. Press the Present key when the LED indicator turns green.

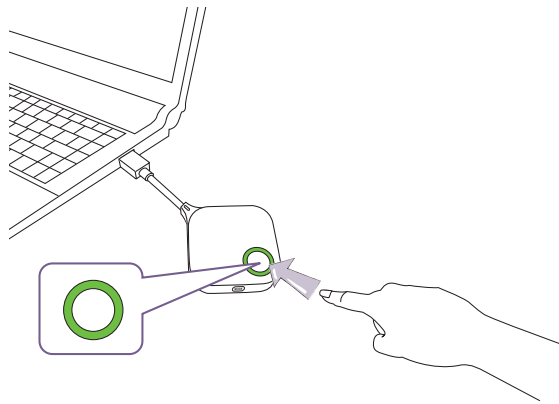

- Handle the InstaShow Button cable with care. Rough handling might cause defects.
- Pull/Push the plug instead of the cable when inserting or removing InstaShow Buttons.

If you purchase an additional InstaShow Button (via an InstaShow Button Kit), please follow the process described below:

- I. Connect the InstaShow Button's USB-C™ jack to the corresponding input of a laptop. See the illustration.

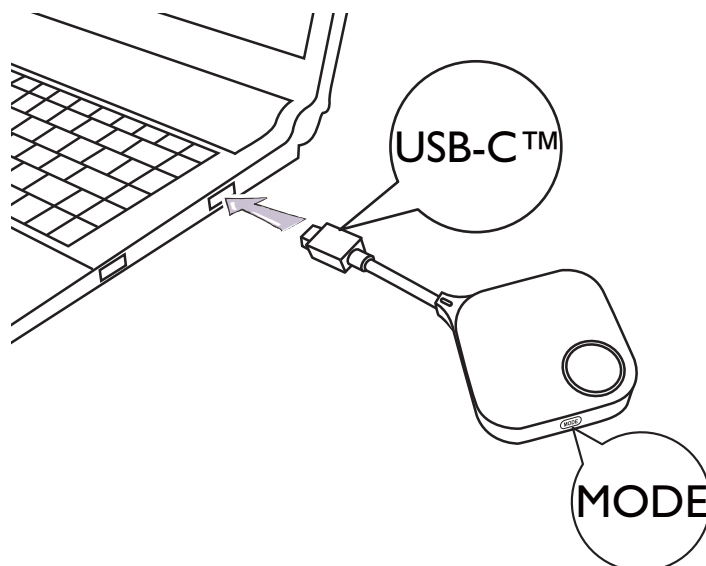

2. The LED indicator of the InstaShow Button will flash red while the InstaShow Button is starting up.

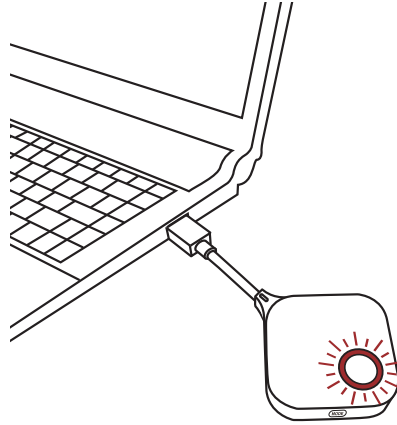

3. When the InstaShow button is ready to present, the LED indicator will turn green. Press the Present key when the LED indicator turns green.

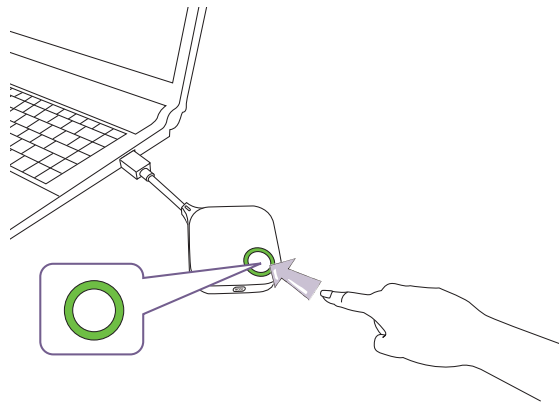

-
- Handle the InstaShow Button cable with care. Rough handling might cause defects.
 - Pull/Push the plug instead of the cable when inserting or removing InstaShow Buttons.
-

Pairing a InstaShow Button and InstaShow Host

A InstaShow™ set includes an InstaShow Host and two InstaShow Buttons, which are paired before shipment. In such a case, you don't need to pair them again. However, if you buy two or more sets of InstaShow™, and you want to pair an InstaShow Button with a different InstaShow Host, you need to follow the instruction below. If you buy an additional InstaShow Button kit, and you want to pair the new InstaShow Buttons with your InstaShow Host, you need to follow the instruction below as well.

When the InstaShow Host is placed on a table

1. Make sure your InstaShow Host is ready with power supply. Connect the InstaShow Button's USB-C™ jack to the corresponding input of a laptop.

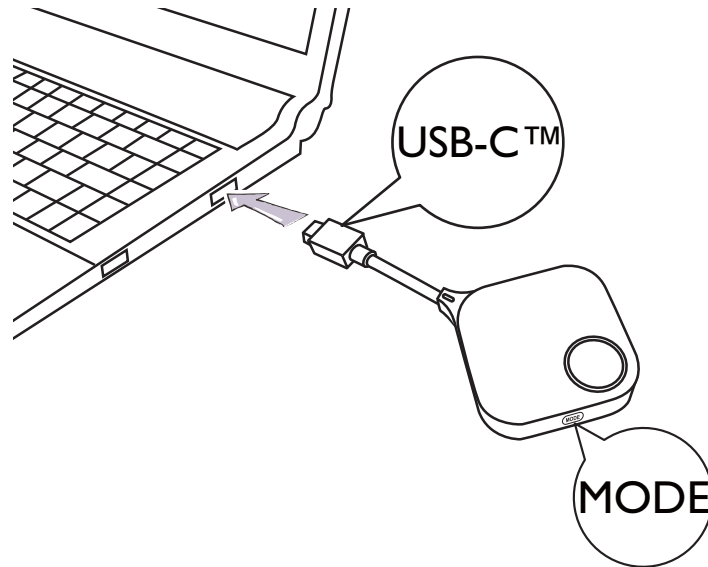

2. When the InstaShow Button is connected to the laptop, the LED indicator of the InstaShow Button will flash red. The InstaShow Button is in pairing mode, waiting to pair with your InstaShow Host.

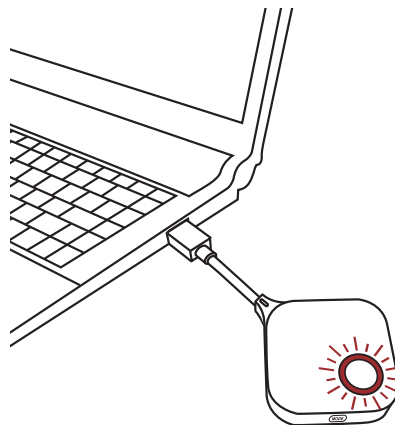

If an InstaShow Button nearby has been paired with an InstaShow Host before, it will turn static green.

3. Press the **PAIRING** key of the InstaShow Host for five seconds, the LED indicator of the InstaShow Host will blink blue for two minutes, waiting to pair with an InstaShow Button.

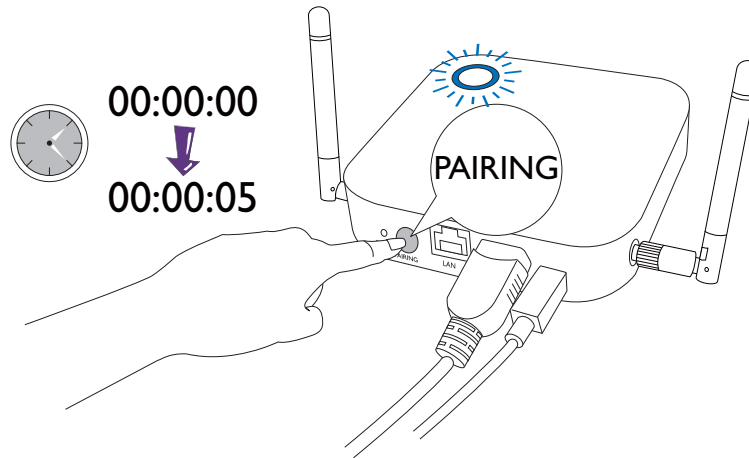

If the InstaShow Host is attached to the ceiling so that it is not easy to press the **PAIRING** key, please use the pairing process in the web management interface. Refer to [Pairing on page 46](#) for information.

4. Press the **MODE** key on the side of the InstaShow Button for five seconds. The LED indicator of the InstaShow Button will blink blue for about 10 seconds. The pairing process is ongoing. The “Pairing” message will be shown on the screen.

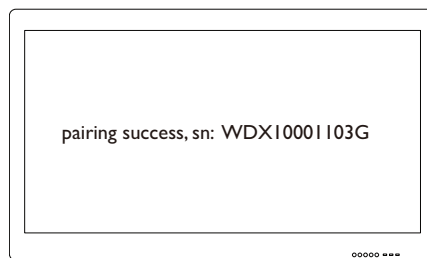
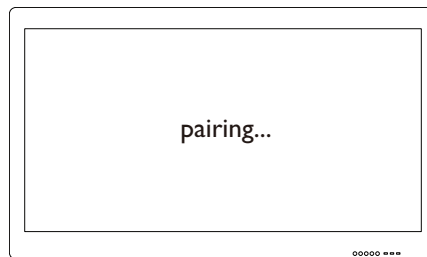
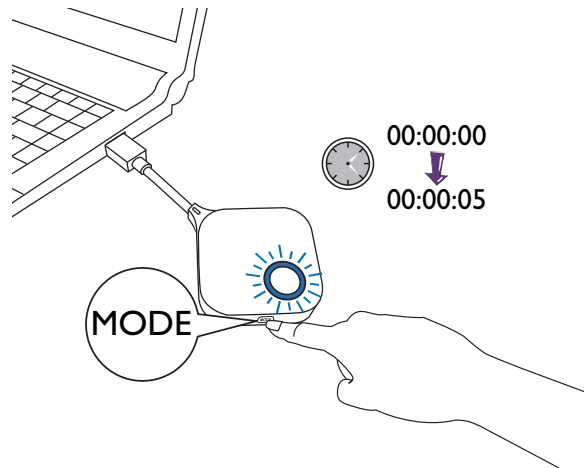

The images are for reference only. Each product has different serial number.

- The LED indicator of the InstaShow Button turns static green when the InstaShow Host and InstaShow Button are successfully paired.

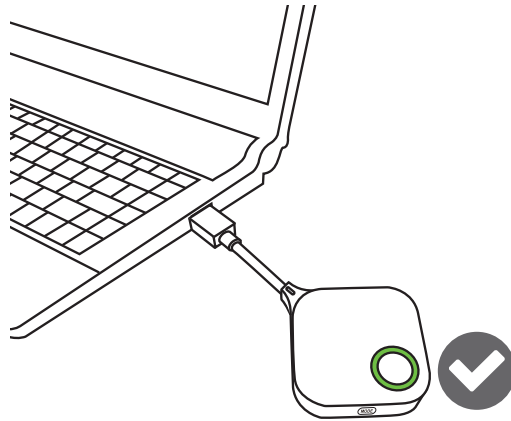

The maximum number of InstaShow Buttons you can pair with one InstaShow Host is 16.

Waking up the InstaShow Host

When the InstaShow Host's power indicator turns 50% static green, press the Present key of the InstaShow Button to start a presentation, and the InstaShow Host will wake up automatically.



More standby mode and wake up options are configurable via the web management user interface. Refer to [page 52](#) for information.

Storing InstaShow Buttons in the cradle

You are provided with two different ways to store the InstaShow Buttons in the cradle. Place the InstaShow Buttons in the cradle vertically (1) or horizontally (2). See the illustrations.

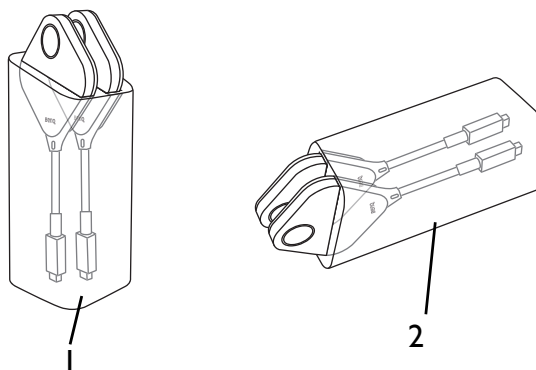

Resetting a InstaShow Host

Resetting an InstaShow Host allows you to return the InstaShow Host to its original factory settings. You may want to reset the InstaShow Host because of either one of the following reasons:

- You want to clear the web management interface of all changes made to its configurations, such as pairing information, passwords, SSID, Frame Rate, etc. and return it back to its default settings. Refer to [Web management on page 34](#) for more information.
- You are unable to access the web management interface (for instance due to an altered or lost password).

Reset the InstaShow Host using the following steps:

1. Connect the DC/Micro-USB port on the InstaShow Host to a power source and wait for at least 30 seconds.



After the InstaShow Host has been connected to a power source for at least 30 seconds, the InstaShow Host LED may indicate any one of the statuses described in [LED indicators of the InstaShow Button and InstaShow Host](#). As long as the InstaShow Host has been connected to a power source for at least 30 seconds, you may proceed to the next step of the resetting process regardless of the status of the InstaShow Host LED.

2. Poke the **RESET** hole at the rear of the InstaShow Host with a pin for at least 2 seconds.

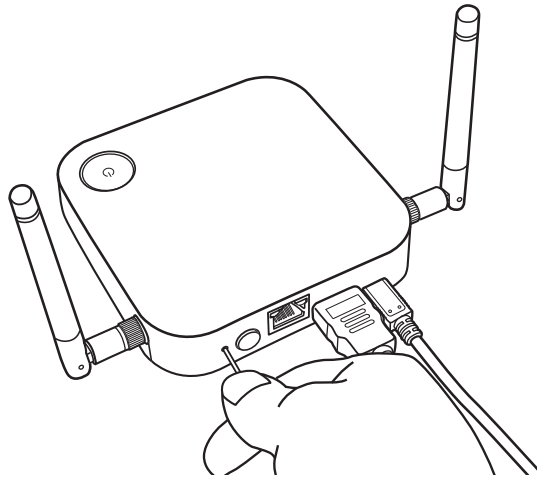

3. The InstaShow Host LED will begin quick flashing red (flash red twice every second) for 10 seconds, then light up static red for 15 to 20 seconds, indicating that the InstaShow Host is resetting.
 4. Once the InstaShow Host LED lights up static green the resetting process is complete.
-



Do not disconnect the InstaShow Host from its power source at any time during the resetting process.

Resetting a InstaShow Button

Resetting an InstaShow Button allows you to return the InstaShow Button to its original factory settings. You may want to reset an InstaShow Button because it has been paired to a different InstaShow Host (one which was not originally included with the InstaShow Button in the package), and you want to quickly pair it back to its original InstaShow Host.

Reset an InstaShow Button using the following steps:

1. Place the InstaShow Button within range of the original InstaShow Host and ensure the LED on the InstaShow Host is static green.

2. Connect the USB-C™ connector on the InstaShow Button to a powered on laptop and wait for at least 30 seconds.



After the InstaShow Button has been connected to a powered on laptop for at least 30 seconds, the InstaShow Button LED may indicate any one of the statuses described in [LED indicators of the InstaShow Button and InstaShow Host](#). As long as the InstaShow Button has been connected to a powered on laptop for at least 30 seconds, you may proceed to the next step of the resetting process regardless of the status of the InstaShow Button LED.

3. Poke the **RESET** hole at the bottom of the InstaShow Button with a pin for at least 2 seconds.

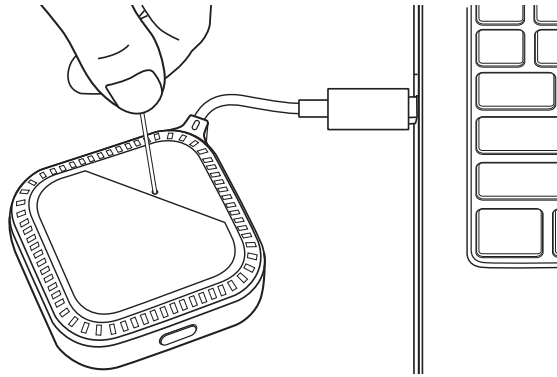

4. The InstaShow Button LED will begin quick flashing red (flash red twice every second) for 10 seconds, then light up static red for 15 to 20 seconds, indicating that the InstaShow Button is resetting.

5. Once the InstaShow Button LED lights up static green the resetting process is complete.

You may also want to reset an InstaShow Button under either one of the following conditions:

- You purchased an additional InstaShow Button (via an InstaShow Button Kit) which has not been paired to an InstaShow Host.
- An InstaShow Button that was included in the original package has been paired to a different InstaShow Host (one which was not originally included with the InstaShow Button in the package), and you want to re-pair the InstaShow button to its original InstaShow Host while the InstaShow Host is not powered on.

Under these conditions where the InstaShow Button is not connected to the corresponding InstaShow Host and its LED flashes red, use the following steps to reset the InstaShow button:

1. Connect the USB-C™ connector on the InstaShow Button to a powered on laptop and wait for at least 30 seconds.



After the InstaShow Button has been connected to a powered on laptop for at least 30 seconds, the InstaShow Button LED may indicate any one of the statuses described in [LED indicators of the InstaShow Button and InstaShow Host](#). As long as the InstaShow Button has been connected to a powered on laptop for at least 30 seconds, you may proceed to the next step of the resetting process regardless of the status of the InstaShow Button LED.

2. Poke the **RESET** hole at the bottom of the InstaShow Button with a pin for at least 2 seconds.

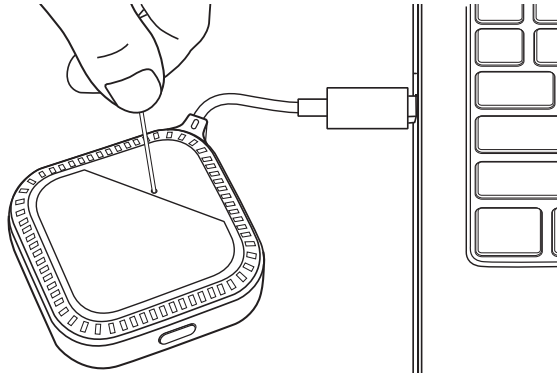

3. The InstaShow Button LED will begin quick flashing red (flash red twice every second) for 10 seconds, then light up static red for 15 to 20 seconds, indicating that the InstaShow Button is resetting.
4. Once the InstaShow Button LED flashes red the resetting process is complete.



Do not disconnect the InstaShow Button from its power source at any time during the resetting process.

Starting and stopping presentations

This section will guide you on how to start and stop a presentation using InstaShow™.

Getting ready

Make sure that all the connected devices have been powered on and ready for the presentation.

As your InstaShow™ could work with different projectors, IFPs, TVs, or monitors with standard HDMI ports, the steps required to start a presentation may vary according to the actual environment and your display specifications. Follow the procedures below and refer to the specified sections for details.

1. To start a presentation, see [Starting presentation on page 29](#) for details.
2. To stop a presentation, see [Idle presentation on page 31](#) for details.
3. To learn more about InstaVideo, see [Play video with InstaShow™ on page 32](#) for details.

Starting presentation

1. Make sure power is supplied to the InstaShow Host. See [Connecting the HDMI cable and power on page 16](#) for more information.
2. Choose the HDMI source corresponding to the InstaShow Host on the display. You will see the Guide screen.

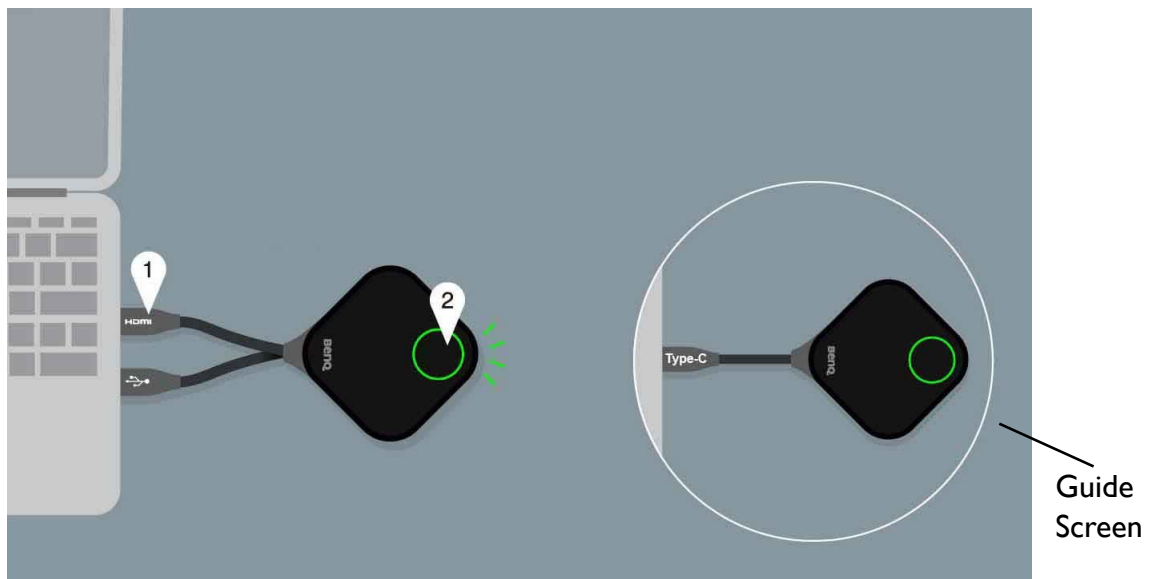

Depending on the purchased model, you may have different cable(s) on InstaShow Buttons. Connect the InstaShow Button's jack(s) to the corresponding input(s) of a laptop.

3. Please follow the instruction on the Guide screen to supply power to the InstaShow Button. You can also see [Setting up and powering an InstaShow Button on page 19](#) for more information. The LED indicator on the InstaShow Button is static green when the InstaShow Button is connected and working properly. You will then see the Idle screen.

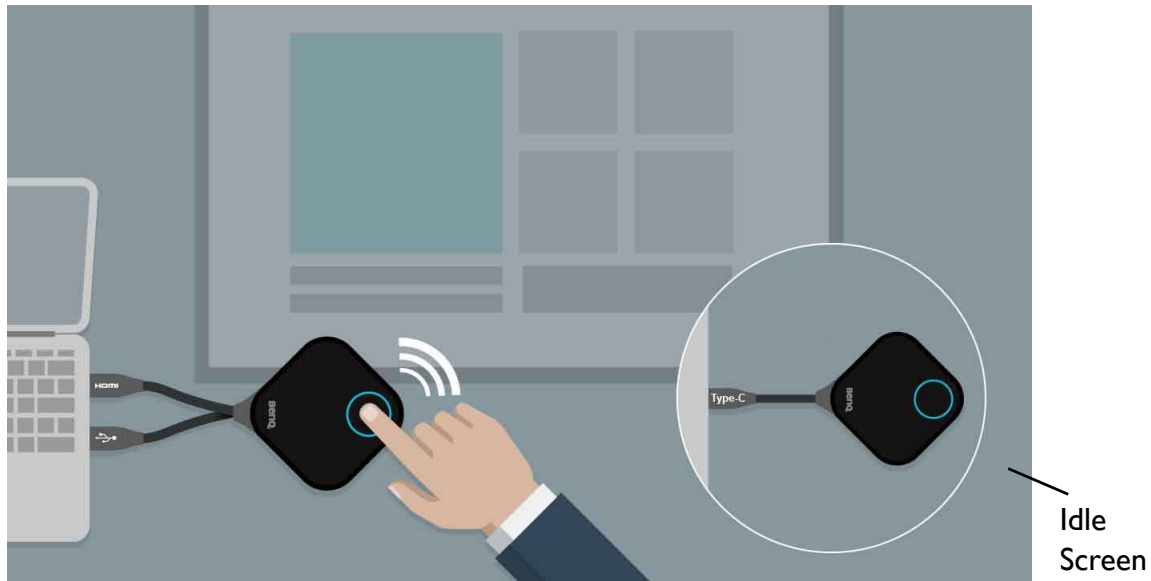

4. To start a presentation, press the Present key.
5. The device starts presenting, and the LED indicator of the InstaShow Button turns static blue.

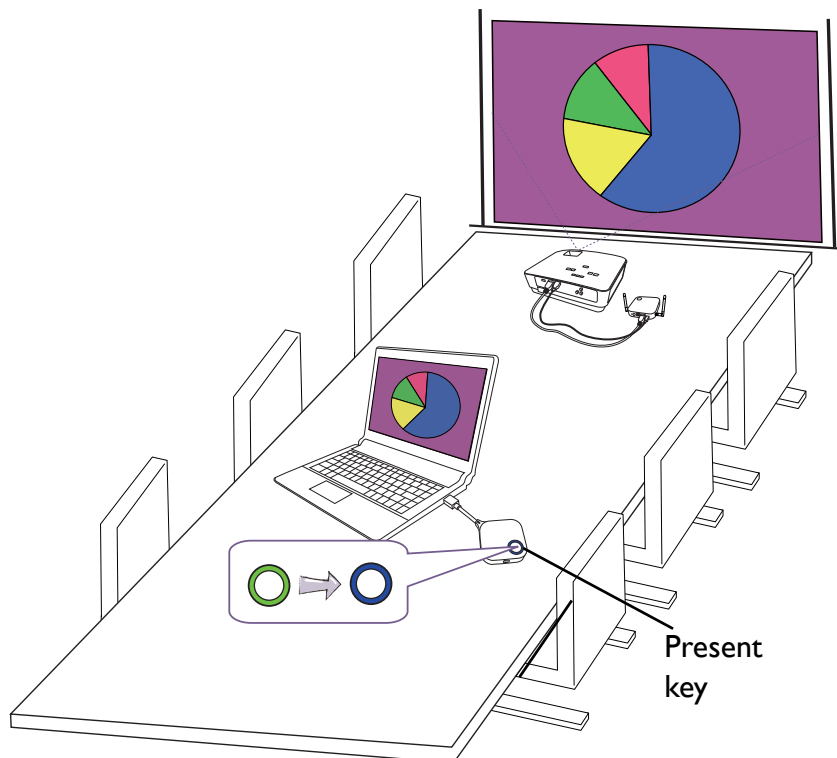

- Make sure the transmission distance between the InstaShow Button and InstaShow Host is within 8M and with no obstacles.
- InstaShow™ supports MacBooks and Windows laptops to mirror an extended desktop.

Idle presentation

1. To stop a presentation, press the Present key.
2. The device stops presenting, and the LED indicator of the InstaShow Button turns green.
3. Users can press the Present key to return to the presentation.

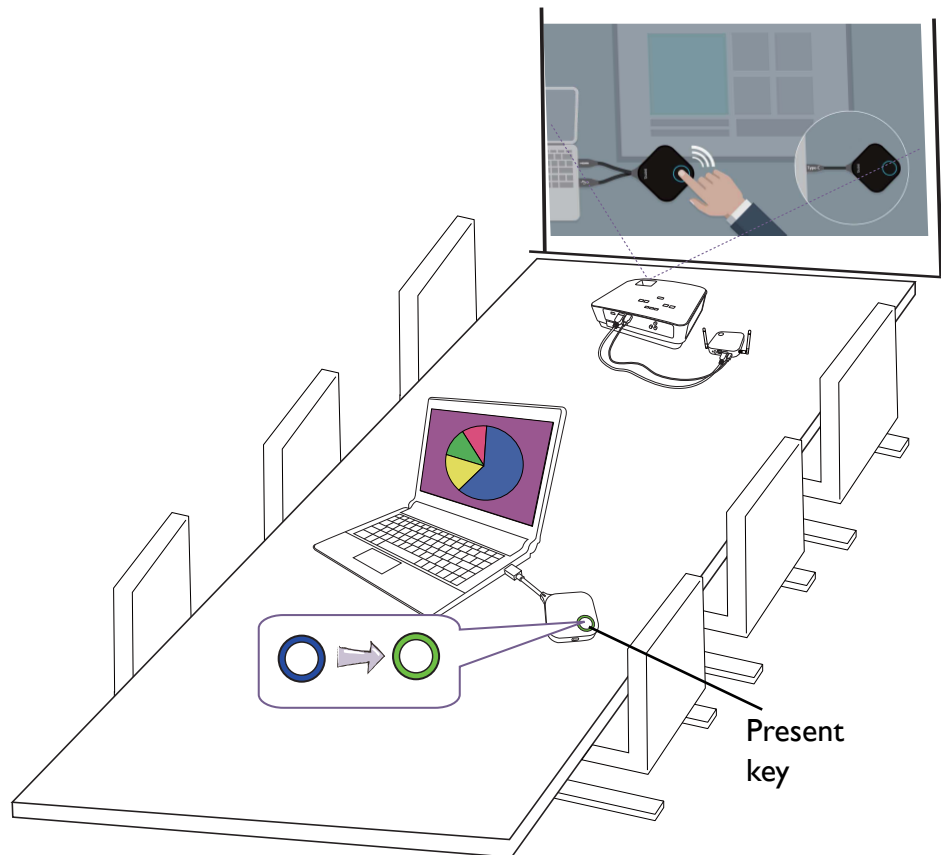

Play video with InstaShow™

Our exclusive InstaVideo function optimizes InstaShow™'s audiovisual settings to instantly switch from clear **Presentation** mode to smooth **Video** mode with stereo sound at the click of a button without requiring IT support, cable clutter or complex software settings. By enabling presenters to quickly customize the projection for precise productivity or smooth wireless Full HD 1080p video, users can confidently blend text, graphs and charts, pictures, and multimedia audio and video without hesitation for the most effective meetings.

InstaVideo introduces two modes: **Presentation** mode and **Video** mode.

1. The default mode is **Presentation** mode. It presents clear document files.

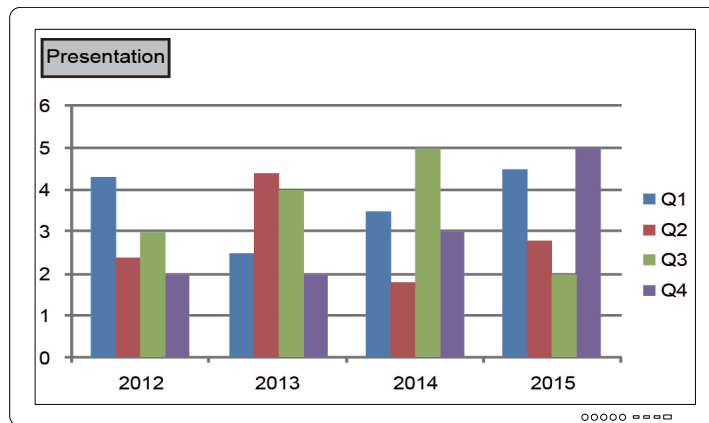

2. If you want to view your full HD 1080p video projected smoothly, switch to **Video** mode by pressing the **MODE** key to proceed.

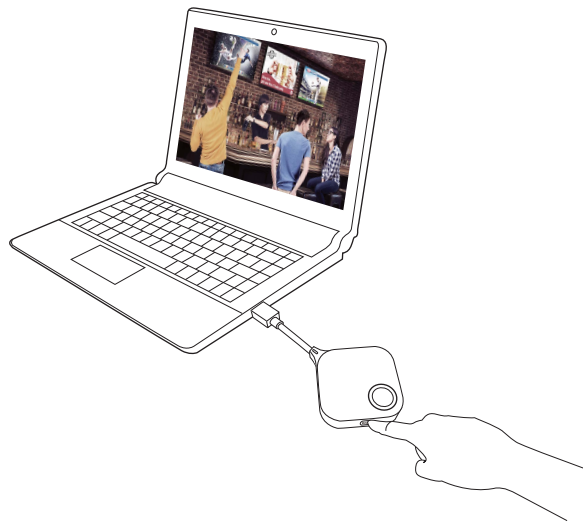

3. You can see the **Video** message on the upper left corner of the screen. Now you can play full HD 1080p videos smoothly.

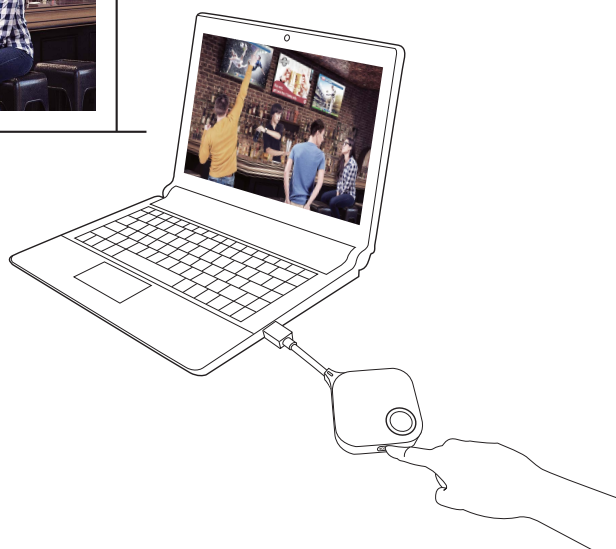
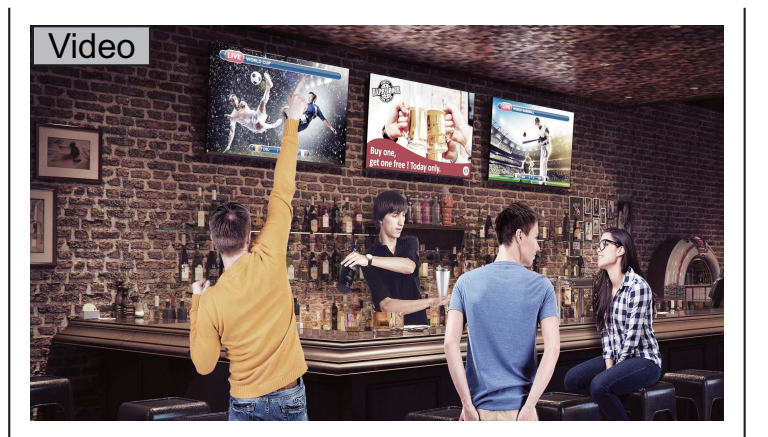

InstaShow™ is primarily for the use of business presentation with documents such as PowerPoint, Word, Excel, PDF, and Full HD video clips. If users have home theater wireless video display demand, please contact local agent about BenQ WDP02 product for home entertainment usage.

Web management

Your InstaShow™ is equipped with a web management interface that enables you to configure its features through a browser such as Google Chrome (version 49.0.26), Internet Explorer (version 8.0), or Firefox (version 46.0.1).



The features may vary according to different firmware versions.

Accessing the web management interface

Logging into the web management interface via direct connection

1. Connect your InstaShow Host directly to a laptop using a network cable (RJ-45) and to a power source using a USB A(M) to micro B(M) cable.

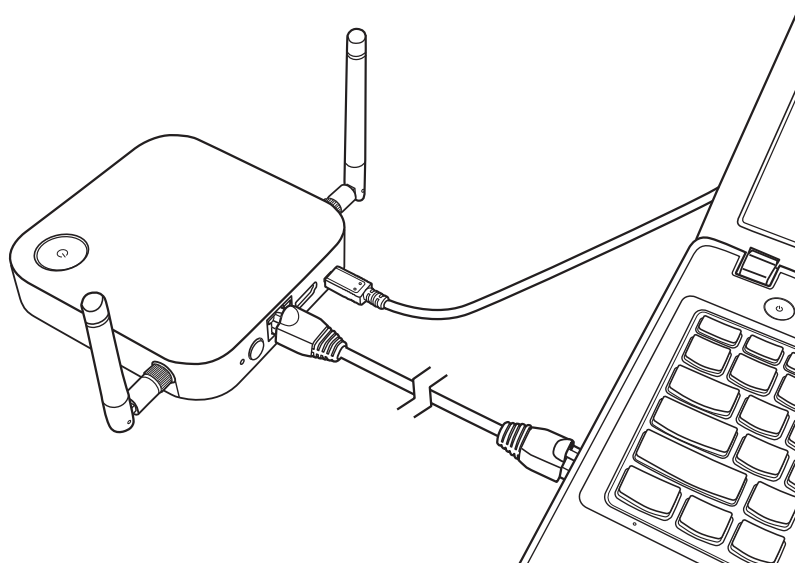

2. Wait until the LED indicator on your InstaShow Host lights up static green.

- The default IP address of your InstaShow Host is 192.168.20.1. Change your laptop's IP address to 192.168.20.x (e.g. 192.168.20.100).

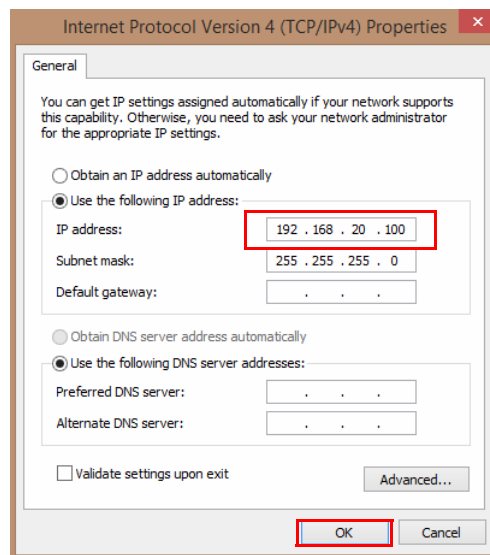
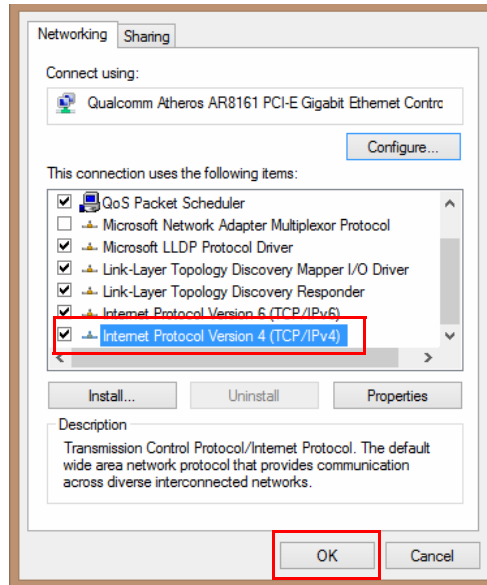

- On your browser, enter the IP address: 192.168.20.1. On the login page, enter the default user name (admin) and password (0000).

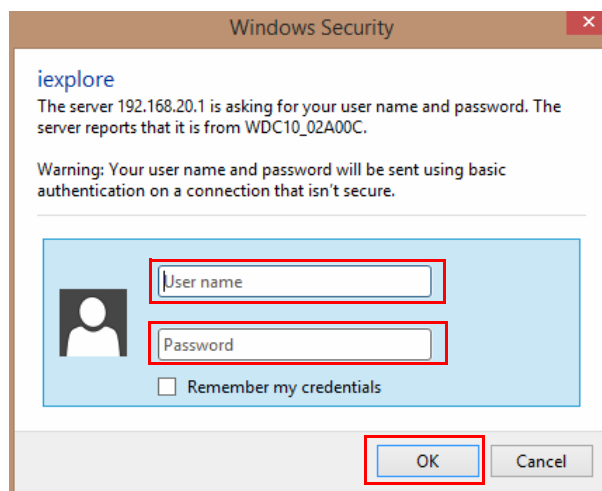

- You will successfully log into the web management interface.

Logging into the web management interface via LAN

If your InstaShow Host is connected to your LAN, you can enter the IP Address shown on the screen via a web browser.

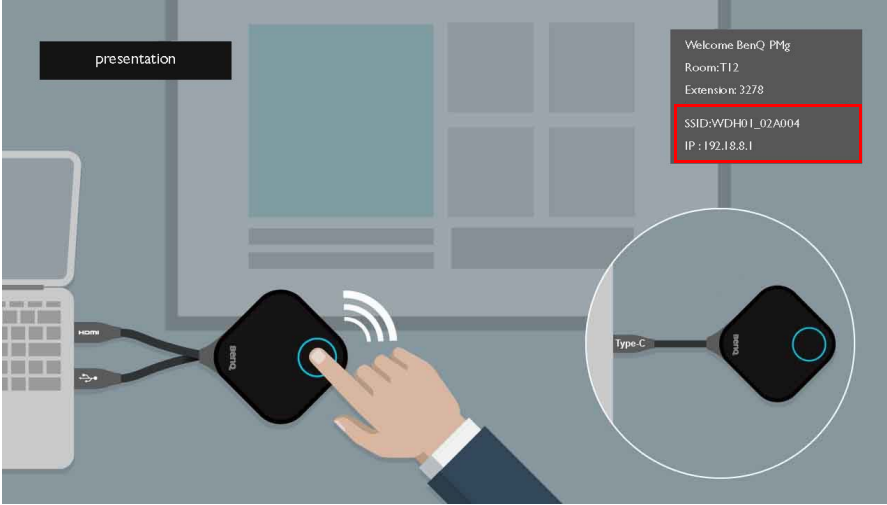

presentation

Welcome BenQ PMg
Room: T12
Extension: 3278
SSID: VVDH01_02A004
IP: 192.18.8.1

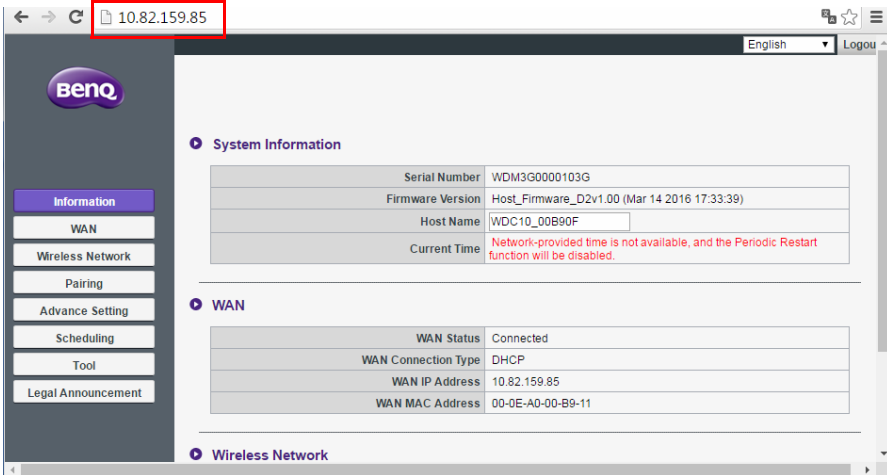

10.82.159.85

English Logou

BENQ

Information

- Information
- WAN
- Wireless Network
- Pairing
- Advance Setting
- Scheduling
- Tool
- Legal Announcement

System Information

Serial Number	WDM3G0000103G
Firmware Version	Host_Firmware_D2v1.00 (Mar 14 2016 17:33:39)
Host Name	WDC10_00890F
Current Time	Network-provided time is not available, and the Periodic Restart function will be disabled.

WAN

WAN Status	Connected
WAN Connection Type	DHCP
WAN IP Address	10.82.159.85
WAN MAC Address	00-0E-A0-00-B9-11

Wireless Network

Logging into the web management interface via a wireless network

InstaShow™ only supports 802.11ac. If your laptop or mobile device has 802.11ac (5G Wi-Fi) wireless capability, you can locate the InstaShow Host via the WDC10_XXXXXX SSID (shown on the upper right corner of the Guide/Idle screen) in your laptop or mobile device's wireless network menu and connect to it. The default password is the same as the name of the SSID (for example, if the SSID is "WDC10_02A00C", the password will be "WDC10_02A00C"). When the device is connected to the InstaShow Host, enter the IP Address, "192.168.168.2" in a web browser, then enter the user name and password as shown in step 4 of [Logging into the web management interface via direct connection on page 34](#).



When an InstaShow Host is properly installed it will broadcast 2 separate SSIDs: one for access to the web management interface (with a name of "WDC10_XXXXXX"), and another used for data transfer between the InstaShow Host and InstaShow Buttons (with a name of "WHE_AP_5G_XXXXXX"). For access to the web management interface ensure that your laptop or mobile device only connects to the "WDC10_XXXXXX" SSID.

The following is an example of how you can log into the web management interface via a mobile device with IEEE 802.11ac.

1. Go to **Settings > Wi-Fi**, and you can find the SSID of your InstaShow Host: WDC10_02A00C.



2. Enter the default password "WDC10_02A00C" and press **Connect**.



3. Access the web management interface following step 4-5 of [Logging into the web management interface via direct connection on page 34](#).

Getting started

You can now use the web management interface to configure various settings of your InstaShow Host.

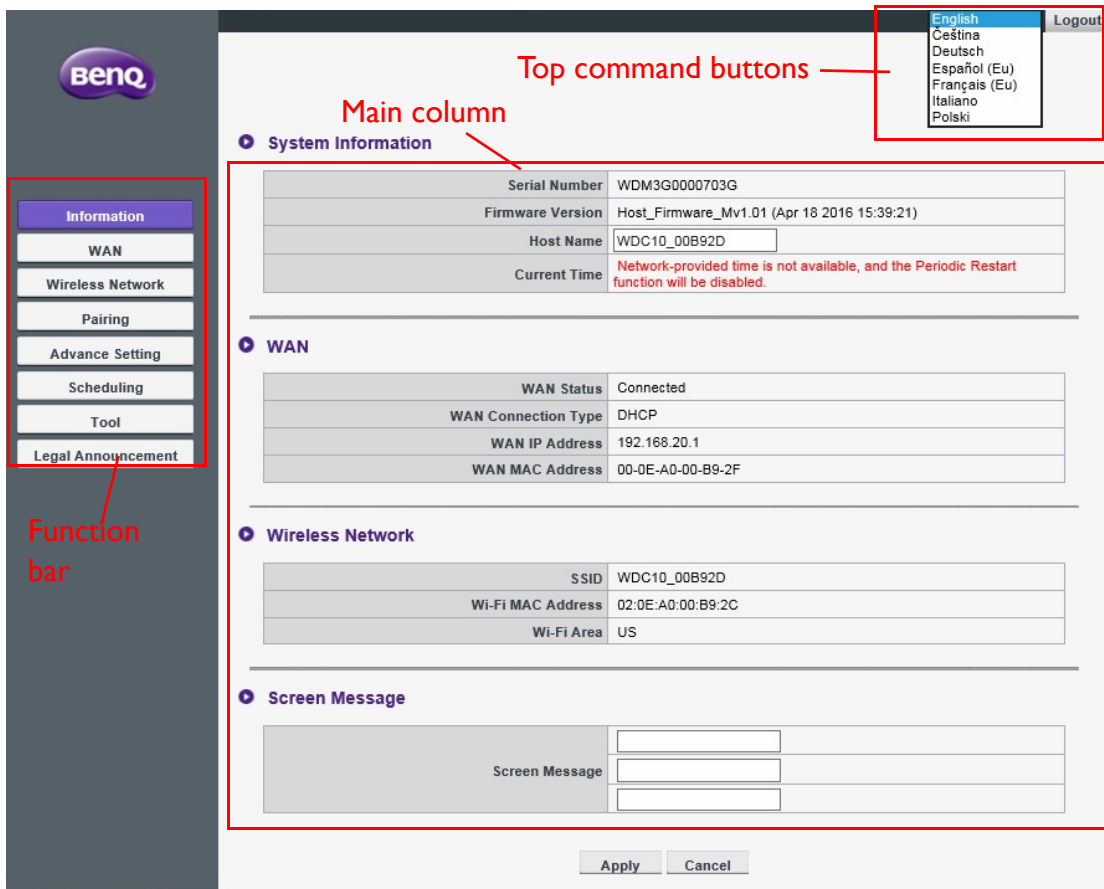

Top command buttons

Change language

1. The default language is English. To change the interface language, go to the language settings panel and you can see all available languages.
2. Click the language you want to switch to and your new language will be set.
3. Once a new language has been set both the web management interface and InstaShow™ OSD will feature the new language.



Supported languages vary by country/region where you purchase.

Logging out

1. Click **Logout** on the upper right corner.

2. A confirmation window will pop up. Press **Apply** to log out.

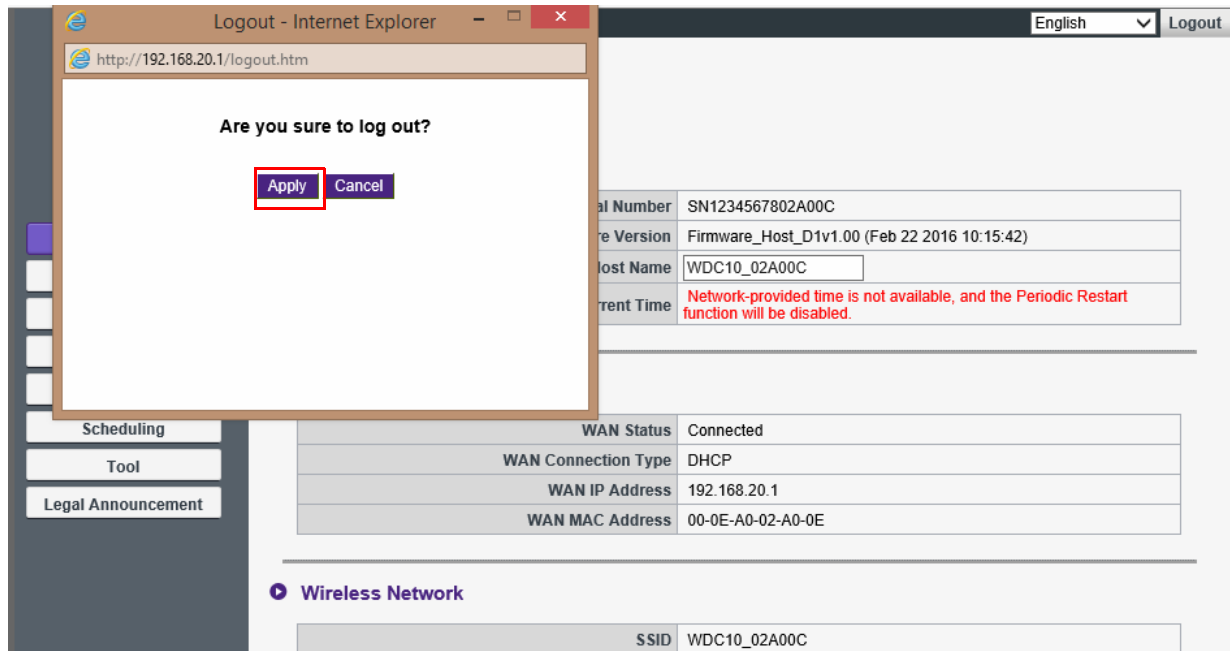

Main column

The main column shows the detailed content from the function bar.

Function bar

Information

Click **Information** and you will see detailed information for **System Information**, **WAN**, **Wireless Network**, and **Screen Message**.

The screenshot shows the BenQ web management interface. On the left is a vertical menu with the BenQ logo at the top and several menu items: Information (highlighted with a red box), WAN, Wireless Network, Pairing, Advance Setting, Scheduling, Tool, and Legal Announcement. The main content area is divided into four sections: System Information, WAN, Wireless Network, and Screen Message. The System Information section contains a table with fields: Serial Number (WDM3G0000703G), Firmware Version (Host_Firmware_Mv1.01 (Apr 18 2016 15:39:21)), Host Name (WDC10_00B92D), and Current Time (Network-provided time is not available, and the Periodic Restart function will be disabled.). The WAN section contains a table with fields: WAN Status (Connected), WAN Connection Type (DHCP), WAN IP Address (192.168.20.1), and WAN MAC Address (00-0E-A0-00-B9-2F). The Wireless Network section contains a table with fields: SSID (WDC10_00B92D), Wi-Fi MAC Address (02:0E:A0:00:B9:2C), and Wi-Fi Area (US). The Screen Message section contains a form with a label 'Screen Message' and three input fields. At the bottom right of the main content area, there are 'Apply' and 'Cancel' buttons. A red arrow points from the text 'Screen Message' to the red error message in the Current Time field of the System Information table.

System Information	
Serial Number	WDM3G0000703G
Firmware Version	Host_Firmware_Mv1.01 (Apr 18 2016 15:39:21)
Host Name	WDC10_00B92D
Current Time	Network-provided time is not available, and the Periodic Restart function will be disabled.

WAN	
WAN Status	Connected
WAN Connection Type	DHCP
WAN IP Address	192.168.20.1
WAN MAC Address	00-0E-A0-00-B9-2F

Wireless Network	
SSID	WDC10_00B92D
Wi-Fi MAC Address	02:0E:A0:00:B9:2C
Wi-Fi Area	US

Screen Message	
Screen Message	<input type="text"/>
	<input type="text"/>
	<input type="text"/>

You can change the **Host Name** under **System Information**.

This is a close-up screenshot of the System Information section. It shows a table with the following data: Serial Number (SN1234567802A00C), Firmware Version (Firmware_Host_D1v1.00 (Feb 22 2016 10:15:42)), Host Name (WDC10_02A00C), and Current Time (Network-provided time is not available, and the Periodic Restart function will be disabled.). The Host Name field is highlighted with a red box.

System Information	
Serial Number	SN1234567802A00C
Firmware Version	Firmware_Host_D1v1.00 (Feb 22 2016 10:15:42)
Host Name	WDC10_02A00C
Current Time	Network-provided time is not available, and the Periodic Restart function will be disabled.

You can enter messages under **Screen Message**. After filling in a message, press **Apply** to proceed. Your message will be shown on the upper right corner of Guide/Idle Screen above SSID.

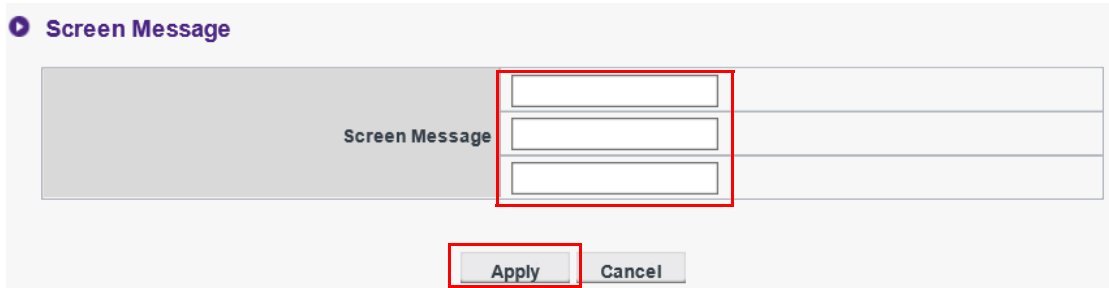

Screen Message

Screen Message

Apply Cancel

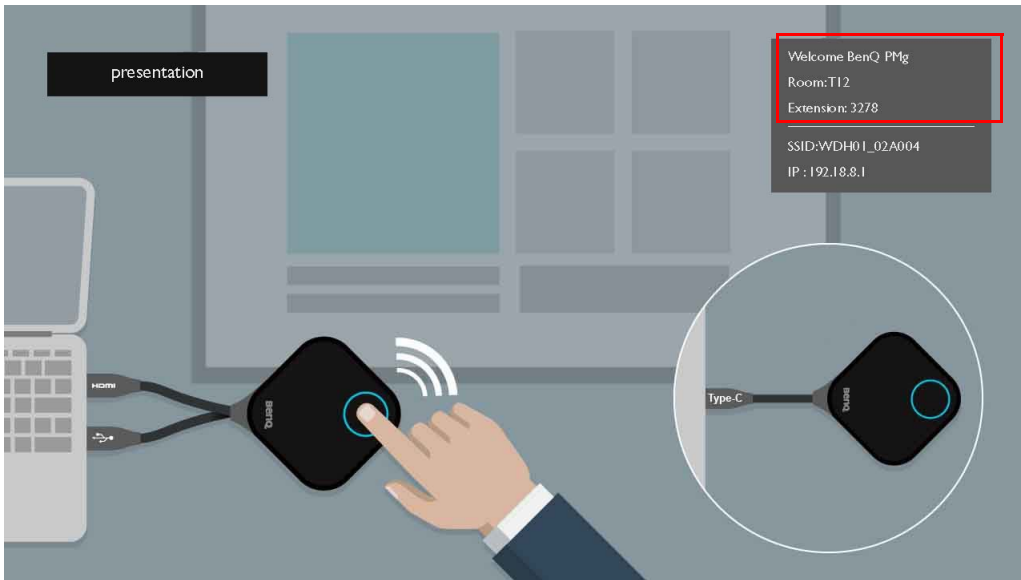

 For **Screen Message**, the maximum lines allowed are 3, and the maximum number of characters allowed per line is 19.

WAN

Click **WAN** and you will see the default **WAN IP Address** of the InstaShow Host. The default connection type is DHCP. Acquire the IP Address from your DHCP server of your network. If you want to change your **WAN IP Address**, choose **Static IP** under **WAN Connection Type**. Press **Apply** after changing the **WAN IP Address**.

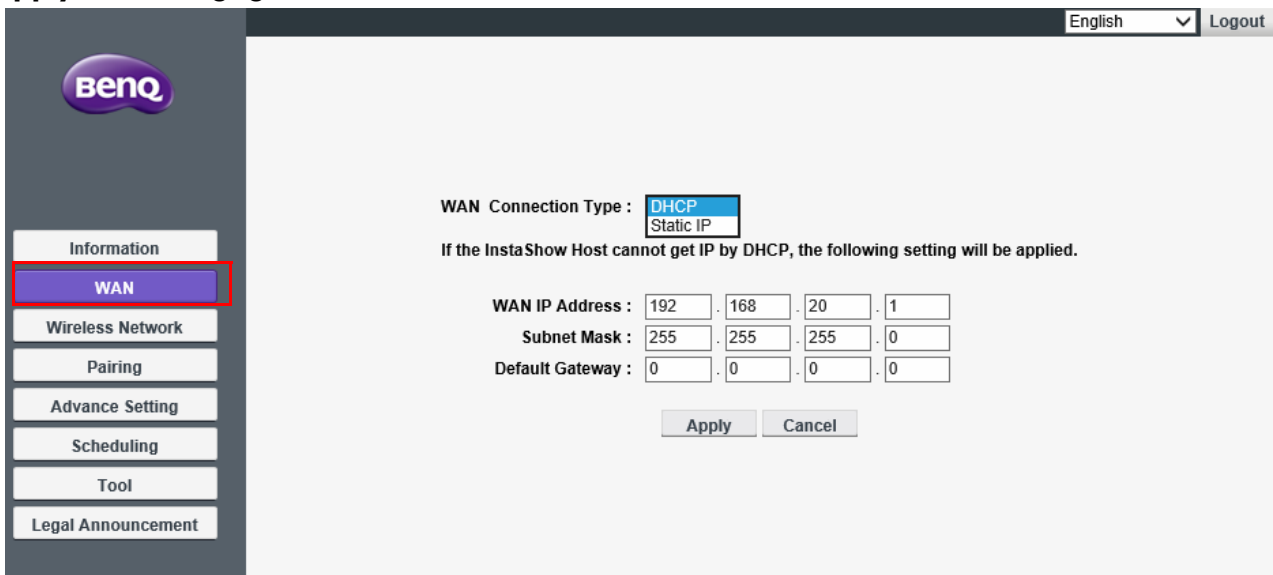

English Logout

BENQ

Information
WAN
Wireless Network
Pairing
Advance Setting
Scheduling
Tool
Legal Announcement

WAN Connection Type : DHCP
Static IP

If the InstaShow Host cannot get IP by DHCP, the following setting will be applied.

WAN IP Address : 192 . 168 . 20 . 1
Subnet Mask : 255 . 255 . 255 . 0
Default Gateway : 0 . 0 . 0 . 0

Apply Cancel

Wireless Network

Click **Wireless Network** and you will see the **Setting** and **Wi-Fi Radio Setup** menu for the InstaShow Host.

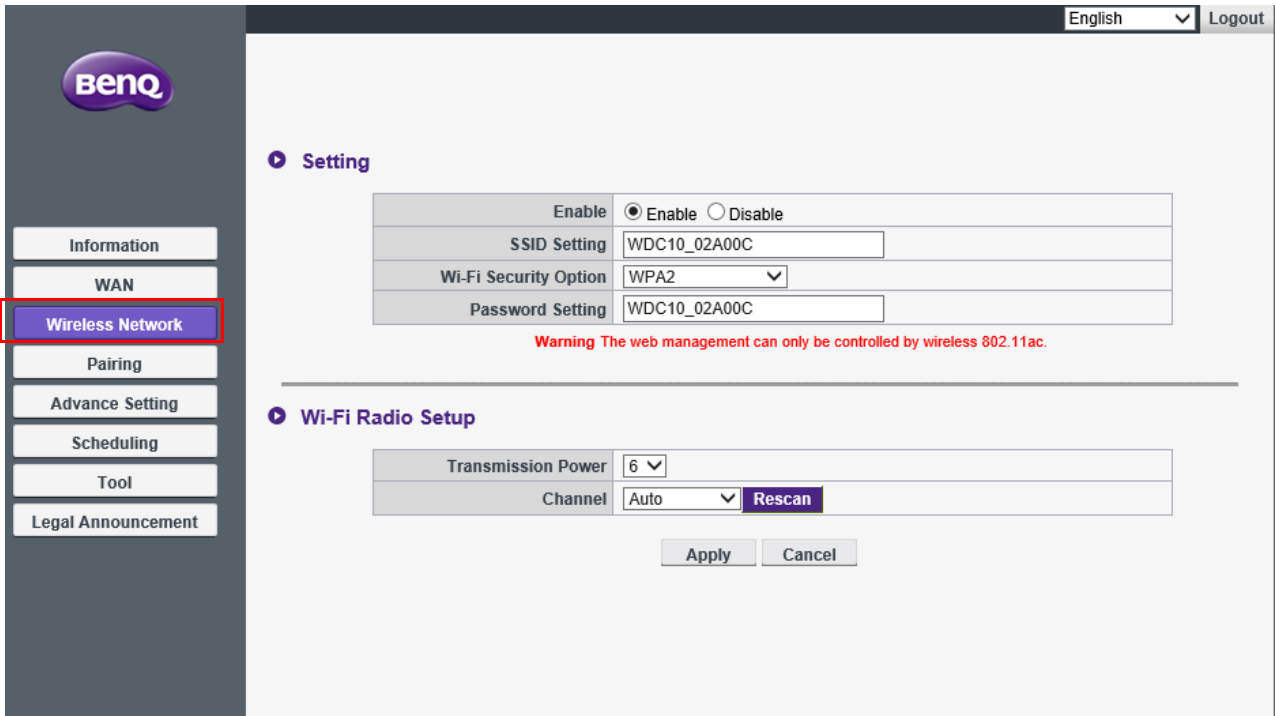

You can **Enable** or **Disable** a Wi-Fi connection to the InstaShow Host via **Enable**. The descriptions for each setting is described below:

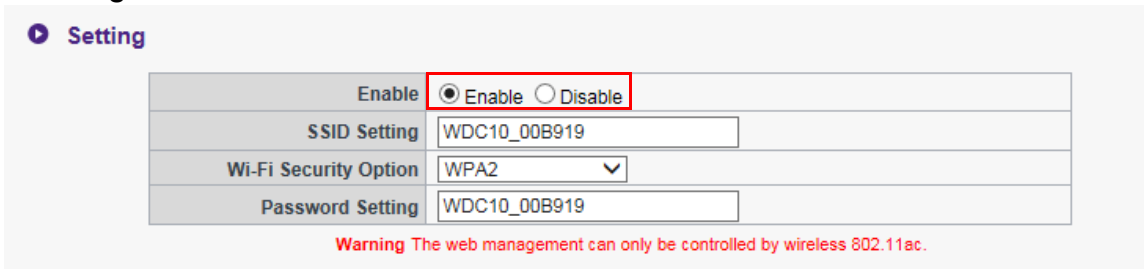

Setting	Description
Enable	The InstaShow Host broadcasts its SSID which allows users to log into the web management interface via a wireless network. Refer to Logging into the web management interface via a wireless network on page 37 for more information.
Disable	The InstaShow Host deactivates its SSID which prohibits users from logging into the web management interface via a wireless network. When Wireless Network is disabled users will only be able to log into the web management interface via direct connection or LAN. Refer to Logging into the web management interface via direct connection on page 34 or Logging into the web management interface via LAN on page 36 for more information.

When **Wireless Network** is enabled you can rename the SSID of the Wi-Fi signal via **SSID Setting**.



The InstaShow Host automatically generates an SSID used for data transfer between the InstaShow Host and InstaShow Buttons (with a name of “WHE_AP_5G_XXXXXX”) which is separate from the SSID used for the web management interface’s wireless connection. This SSID is not displayed in the **Wireless Network** menu as it cannot be changed or edited.

Wi-Fi Security Option provides the user **WPA2** and **WPA2_Enterprise** security options for the InstaShow Host’s wireless connection when users access the web management interface via a wireless network.

Setting

Enable	<input checked="" type="radio"/> Enable <input type="radio"/> Disable
SSID Setting	WDC10_02A00C
Wi-Fi Security Option	WPA2
Password Setting	WDC10_02A00C

Warning The web management can only be controlled by wireless 802.11ac.

WPA2 enables WPA2-PSK (pre-shared key) which uses an Advanced Encryption Standard (AES) encryption method.

WPA2_Enterprise allows users to get a unique key for a network that needs critical authentication. For RADIUS server settings, contact your IT department for actual settings.

Setting

Enable	<input checked="" type="radio"/> Enable <input type="radio"/> Disable
SSID Setting	WDC10_00B90F
Wi-Fi Security Option	WPA2_Enterprise ▼
RADIUS Server IP Address	0 . 0 . 0 . 0
RADIUS Port	1812
Shared Secret	

Warning The web management can only be controlled by wireless 802.11ac.



The Wi-Fi security options described above only applies to the Wi-Fi connection used to access the web management interface via a wireless network. The Wi-Fi connection used for data transfer between the InstaShow Host and InstaShow Buttons utilizes a fixed WPA2-PSK security setting which cannot be changed.

In **Wi-Fi Radio Setup**, you can change **Transmission Power** from 1-6 (6 being the strongest). In the real network environment, every scale-up can increase the signal strength between 1-3 dBm. For

example, changing **Transmission Power** from 1 to 2 can increase the signal strength around 2 dBm in real measurement.

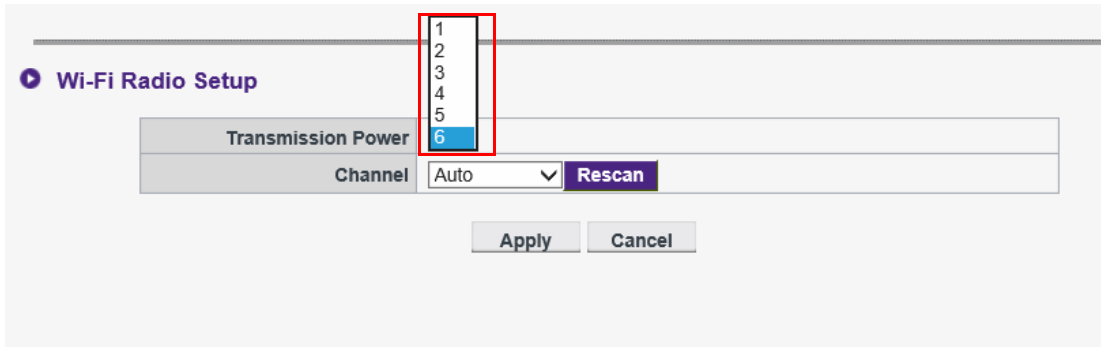

In **Channel**, you can configure the InstaShow Host to automatically select the wireless channel with the best performance during the initial setup of the InstaShow Host by selecting **Auto**, or you can select a wireless channel manually. The default **Channel** setting for the InstaShow Host is **Auto**.

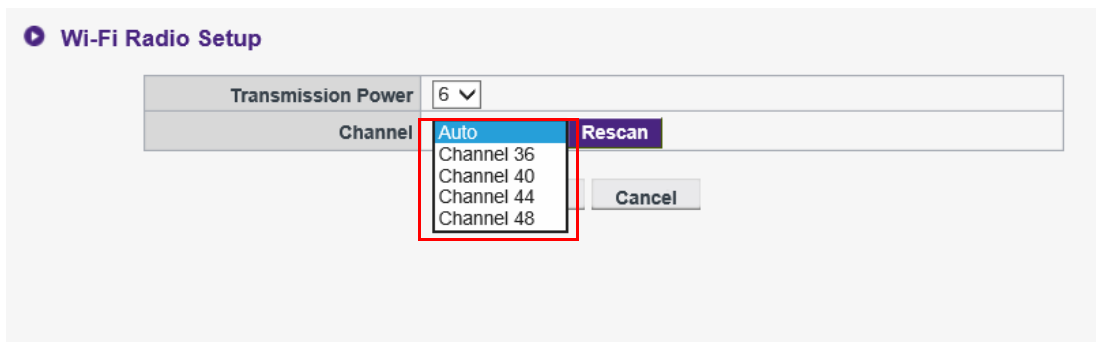

In cases when the broadcast of a presentation is unstable or choppy, due to interference to the wireless connection between the InstaShow Host and InstaShow Button from other wireless devices in the area, users can switch the **Channel** by pressing **Rescan**. By pressing **Rescan** the InstaShow Host will switch to the wireless channel with the best performance and least interference at the time.



- After pressing **Rescan**, the broadcast of the presentation will be interrupted for a few seconds and the LED on the InstaShow Host will flash red then light up static green. Press the Present key on the InstaShow Button afterwards to resume the presentation.
- Supported wireless channels listed may vary according to wireless regulations of the country/region.

After you configure all the **Wireless Network** settings, press **Apply** to proceed.

The screenshot shows the BenQ web management interface. On the left is a navigation menu with the BenQ logo and several menu items: Information, WAN, **Wireless Network** (highlighted), Pairing, Advance Setting, Scheduling, Tool, and Legal Announcement. The top right corner shows 'English' and 'Logout'. The main content area is titled 'Setting' and contains a table of wireless network configuration options:

Enable	<input checked="" type="radio"/> Enable <input type="radio"/> Disable
SSID Setting	WDC10_02A00C
Wi-Fi Security Option	WPA2
Password Setting	WDC10_02A00C

Below the table is a red warning message: **Warning** The web management can only be controlled by wireless 802.11ac.

The next section is titled 'Wi-Fi Radio Setup' and contains a table of radio configuration options:

Transmission Power	6
Channel	Auto Rescan

At the bottom of the 'Wi-Fi Radio Setup' section are two buttons: **Apply** (highlighted with a red box) and **Cancel**.

Pairing

Click **Pairing** and you will see **Pairing** and **Pairing Status**.

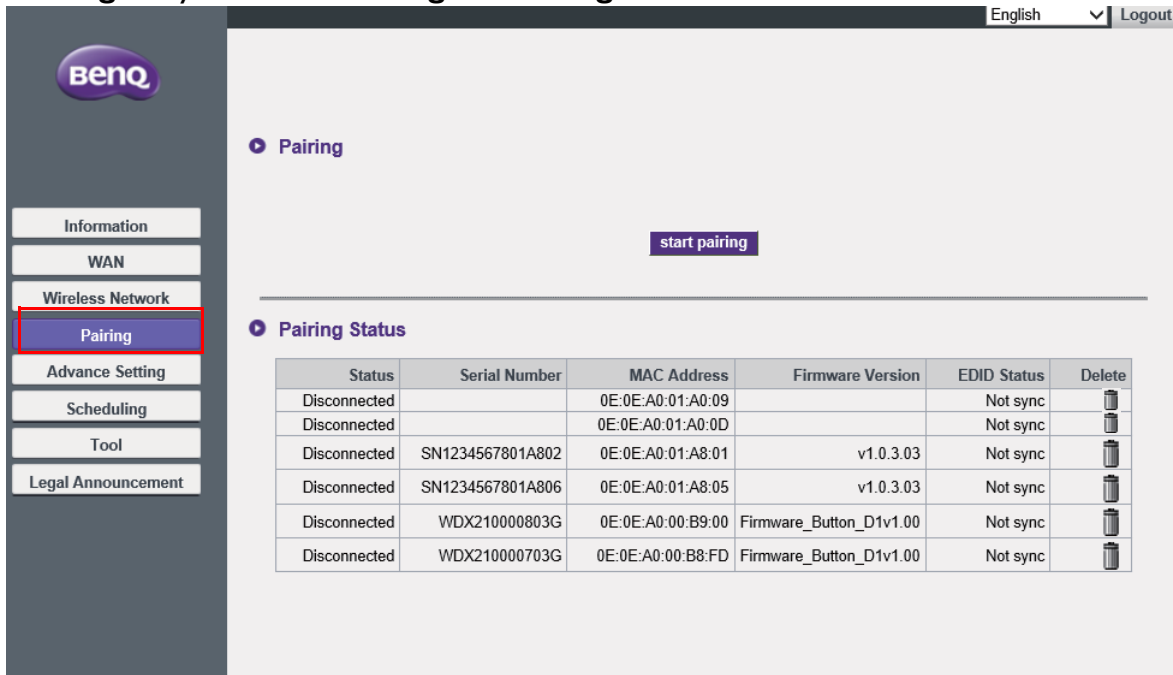

Pairing is used when the InstaShow Host is attached to the ceiling as it is not easy to press the **PAIRING** key of the InstaShow Host when the device is high on the ceiling. You can pair a InstaShow Button and InstaShow Host via the web management interface. See [Advance Setting on page 49](#) for more information about EDID status.

- I. Connect the InstaShow Button's USB-C™ jack to the corresponding port of a laptop.

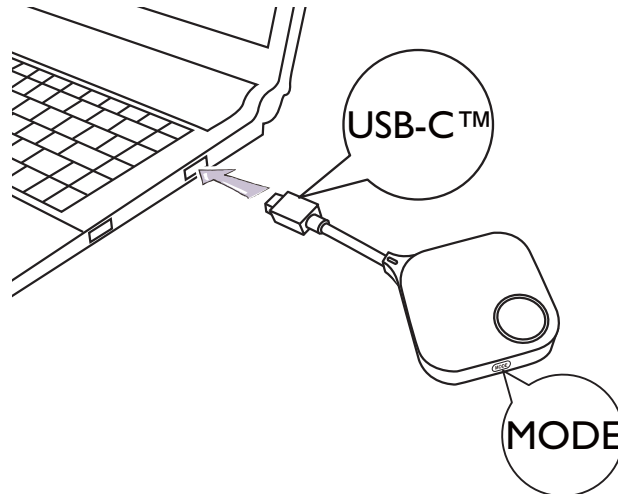

- When the InstaShow Button is successfully connected to the laptop, the LED indicator of the InstaShow Button will blink red.

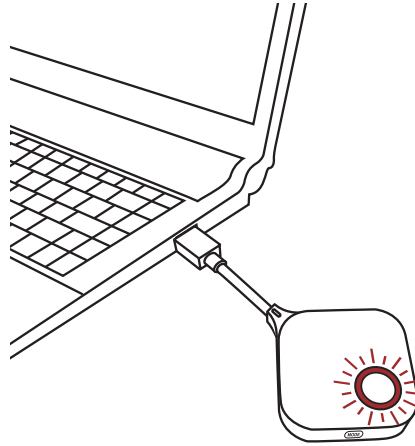

- Make sure the InstaShow Host is properly connected to a power source.
- Press **start pairing** to pair the InstaShow Host to the InstaShow Button via the web management interface, you will have two minutes to pair with the InstaShow Button.

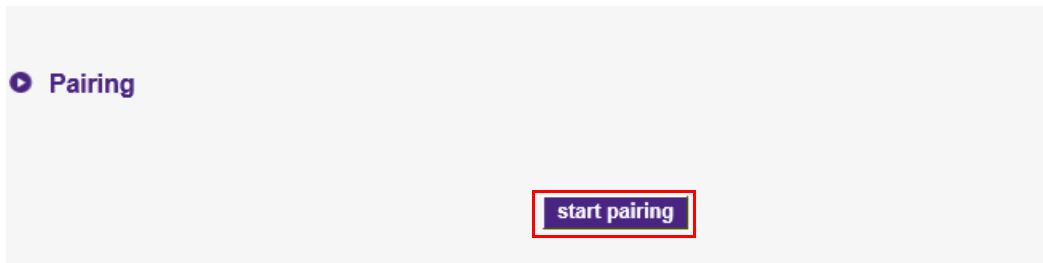

- Press the **MODE** key on the side of the InstaShow Button for five seconds. The LED indicator of the InstaShow Button will blink blue for about 10 seconds. The pairing process is ongoing. A "Pairing" message will be shown on the screen.

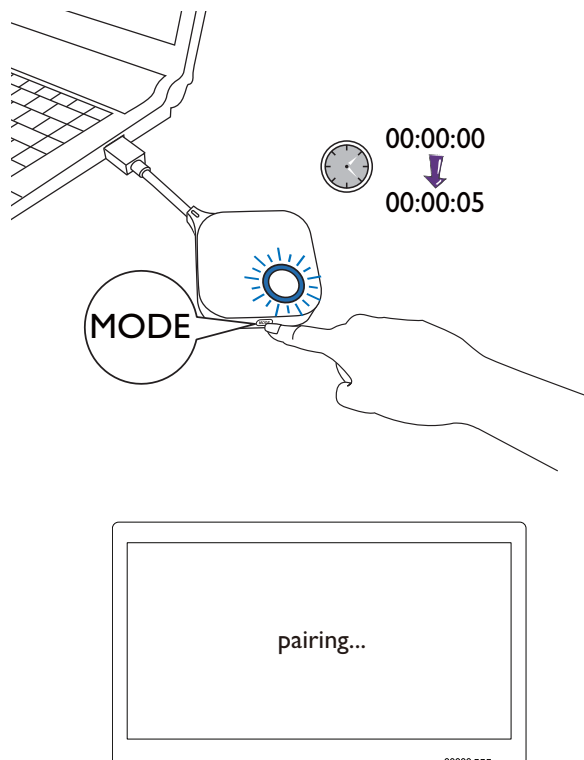

6. The LED indicator of the InstaShow Button will turn static green when the InstaShow Host and InstaShow Button are successfully paired.

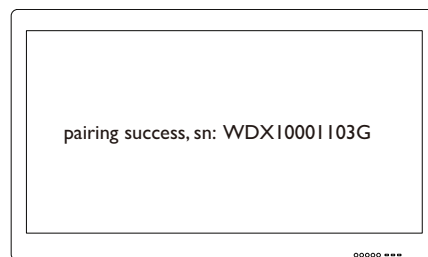
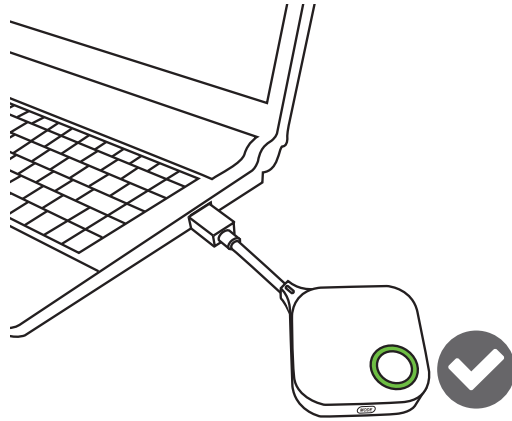

- Images are for reference only. Each product features a different serial number.
- The maximum number of InstaShow Buttons you can pair with one InstaShow Host is 16.

7. You may press **stop pairing** anytime to stop the pairing process.

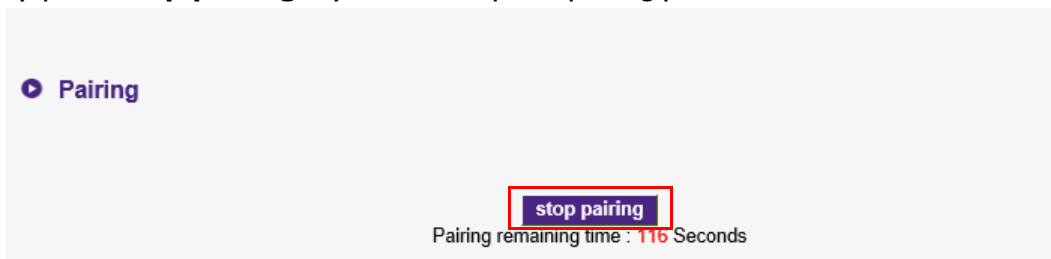

Advance Setting

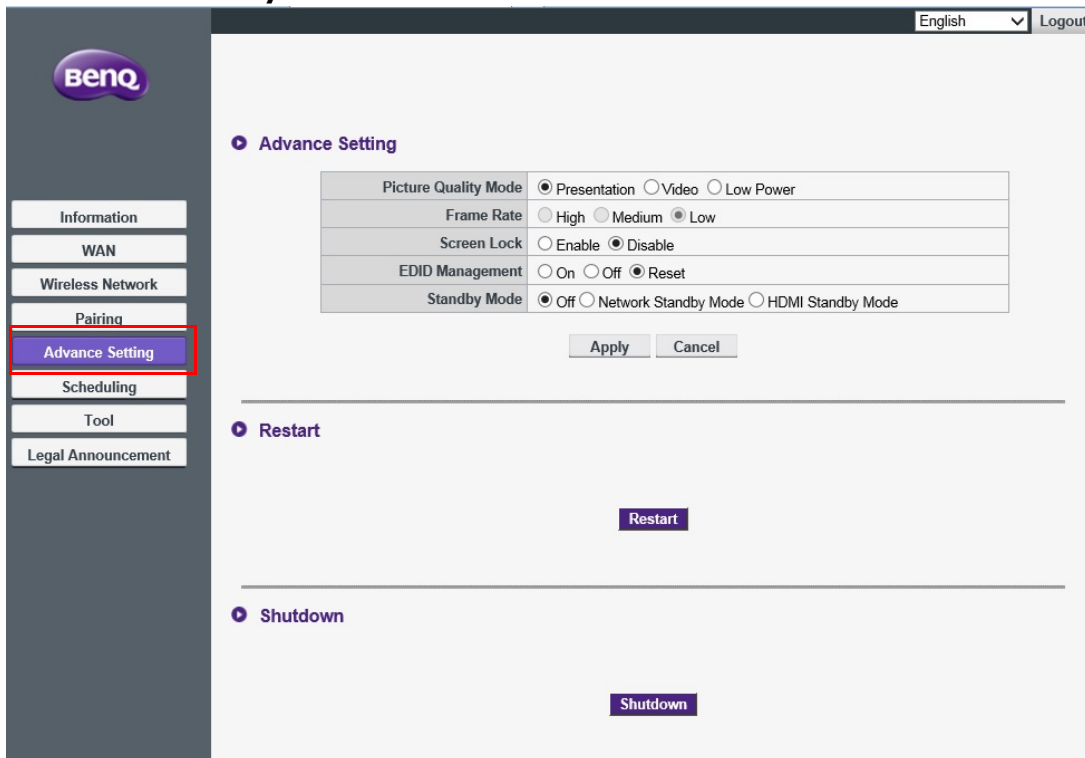

Click **Advance Setting** to adjust **Picture Quality Mode**, **Frame Rate**, **Screen Lock**, **EDID Management**, and **Standby Mode**.

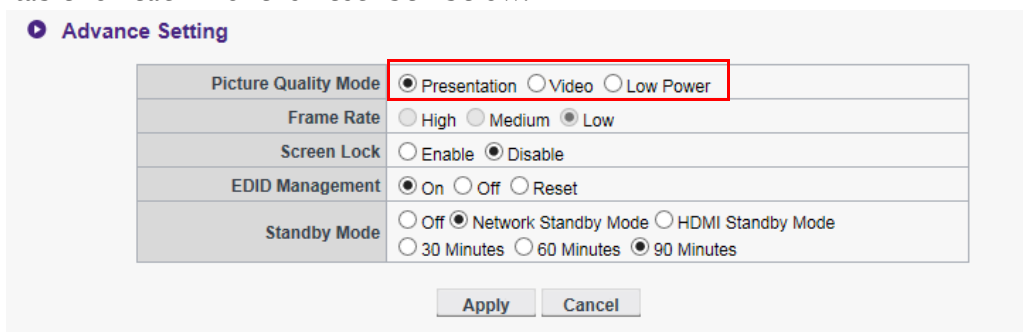

You can change mode to **Presentation** mode, **Video** mode, and **Low Power** via **Picture Quality Mode**. The default mode is **Presentation** mode. Be aware that after the firmware is upgraded to v2.01, the default mode will be changed to **Video** mode. The mode set by **Picture Quality Mode** in web management is the default mode next time when the InstaShow host restarts. That is, if the mode is **Video** mode and is switched to **Presentation** mode by the InstaShow button while playing files, the mode will remain **Video** mode next time the host restarts. A description for the scenarios that are suitable for each mode is described below:



Mode	Scenario
Presentation mode	For use when highly detailed visuals are necessary.
Video mode	For use when smooth video playback is necessary.

Mode	Scenario
Low Power mode	<p>For use when low power consumption is necessary, such as when the laptop which the InstaShow Button is connected to only features a USB 2.0 power connection. The use of Low Power mode will result in a lower display quality and choppy video than Presentation mode and Video mode.</p> <p> When Low Power mode is selected, Picture Quality Mode cannot be changed via the MODE key located on the InstaShow Button. If the user presses the MODE key, the OSD will display the warning icon shown below in the upper left-hand corner:</p> 

Frame Rate controls the smoothness of video broadcast by the InstaShow Host. When **Video mode** is selected you can change the **Frame Rate** for the video broadcast to **High**, **Medium**, or **Low**. A higher frame rate features video with smoother motion, while a lower frame rate features video with choppy motion.

Advance Setting

Picture Quality Mode	<input type="radio"/> Presentation <input checked="" type="radio"/> Video <input type="radio"/> Low Power
Frame Rate	<input checked="" type="radio"/> High <input type="radio"/> Medium <input type="radio"/> Low
Screen Lock	<input type="radio"/> Enable <input checked="" type="radio"/> Disable
EDID Management	<input checked="" type="radio"/> On <input type="radio"/> Off <input type="radio"/> Reset
Standby Mode	<input type="radio"/> Off <input checked="" type="radio"/> Network Standby Mode <input type="radio"/> HDMI Standby Mode <input type="radio"/> 30 Minutes <input type="radio"/> 60 Minutes <input checked="" type="radio"/> 90 Minutes

 **Frame Rate** is only adjustable (its default value is set to **High**) when **Video mode** is selected. The **Frame Rate** for **Presentation mode** and **Low Power mode** are both fixed to **Low** and cannot be adjusted.

Screen Lock allows you to control the availability of the InstaShow Host for use. When **Enable** is selected, use of the InstaShow Host for presentation purposes will be prohibited and a lock screen will be broadcast by the InstaShow Host (as shown below) as the LED flashes red. When **Disable** is selected, normal use of the InstaShow Host is allowed.

⚙ Advance Setting

Picture Quality Mode	<input type="radio"/> Presentation <input checked="" type="radio"/> Video <input type="radio"/> Low Power
Frame Rate	<input checked="" type="radio"/> High <input type="radio"/> Medium <input type="radio"/> Low
Screen Lock	<input type="radio"/> Enable <input checked="" type="radio"/> Disable
EDID Management	<input checked="" type="radio"/> On <input type="radio"/> Off <input type="radio"/> Reset
Standby Mode	<input type="radio"/> Off <input checked="" type="radio"/> Network Standby Mode <input type="radio"/> HDMI Standby Mode <input type="radio"/> 30 Minutes <input type="radio"/> 60 Minutes <input checked="" type="radio"/> 90 Minutes

Apply Cancel



EDID (Extended Display Identification Data) is the data provided by digital displays (e.g. projectors, TVs, etc) to indicate their capabilities to its media source.

When properly connected InstaShow™ delivers HDMI signals from your video source (i.e. laptop, etc.) to the HDMI display. In order to deliver the optimal audio and video format supported by the InstaShow Host, InstaShow button, and HDMI display, the InstaShow Host reads the EDID data provided by the connected HDMI display and determines the optimal video resolution and audio format based on the video resolution and audio format supported by InstaShow™. Once the InstaShow Host decides the optimal video resolution and audio format, the revised EDID will be sent to the InstaShow Button to replace the old EDID. The video source (i.e. laptop, etc.) then automatically outputs the best or suggested video resolution based on the EDID of the connected HDMI display.

In order to check the EDID status, the InstaShow Host reads the EDID whenever a display is plugged in, unplugged, or powered on/off. Whenever the InstaShow Host discovers that the EDID of a connected display has changed (i.e. when there has been a change of display), the InstaShow Button's EDID will be updated when the InstaShow Button or InstaShow Host restarts.

You are suggested to have **EDID Management On** to sync the EDID of the InstaShow Button and the display. If you have **EDID Management Off**, EDID will not be changed. If you have **EDID Management Reset**, EDID will be restored to factory default setting.

Advance Setting

Picture Quality Mode	<input checked="" type="radio"/> Presentation <input type="radio"/> Video <input type="radio"/> Low Power
Frame Rate	<input type="radio"/> High <input type="radio"/> Medium <input checked="" type="radio"/> Low
Screen Lock	<input type="radio"/> Enable <input checked="" type="radio"/> Disable
EDID Management	<input checked="" type="radio"/> On <input type="radio"/> Off <input type="radio"/> Reset
Standby Mode	<input type="radio"/> Off <input checked="" type="radio"/> Network Standby Mode <input type="radio"/> HDMI Standby Mode <input type="radio"/> 30 Minutes <input type="radio"/> 60 Minutes <input checked="" type="radio"/> 90 Minutes

Apply Cancel

Setting	Description
On (Default)	InstaShow™ automatically configures the source notebook's resolution setting to match the display device pixel-by-pixel for perfectly clear picture quality.
Off	InstaShow™ do not configure the source notebook's resolution setting to match the display device pixel-by-pixel for perfectly clear picture quality.
Reset	EDID will be restored to factory default setting.

Standby Mode allows you to set the conditions that place the InstaShow Host in standby. You can have your **Standby Mode Off** to prevent the InstaShow Host from going into standby or choose between **Network Standby Mode** and **HDMI Standby Mode**.

Advance Setting

Picture Quality Mode	<input checked="" type="radio"/> Presentation <input type="radio"/> Video <input type="radio"/> Low Power
Frame Rate	<input type="radio"/> High <input type="radio"/> Medium <input checked="" type="radio"/> Low
Screen Lock	<input type="radio"/> Enable <input checked="" type="radio"/> Disable
EDID Management	<input type="radio"/> On <input type="radio"/> Off <input checked="" type="radio"/> Reset
Standby Mode	<input checked="" type="radio"/> Off <input type="radio"/> Network Standby Mode <input type="radio"/> HDMI Standby Mode

Apply Cancel

Network Standby Mode disables the HDMI output from the InstaShow Host after a set amount of time in which there is no connection with an InstaShow Button. When the InstaShow Host is in **Network Standby Mode** the LED will light up 50% static green and power consumption will be roughly 2W. Three time options are provided for **Network Standby Mode: 30 minutes, 60 minutes, and 90 minutes**.

Advance Setting

Picture Quality Mode	<input checked="" type="radio"/> Presentation <input type="radio"/> Video <input type="radio"/> Low Power
Frame Rate	<input type="radio"/> High <input type="radio"/> Medium <input checked="" type="radio"/> Low
Screen Lock	<input type="radio"/> Enable <input checked="" type="radio"/> Disable
EDID Management	<input type="radio"/> On <input type="radio"/> Off <input checked="" type="radio"/> Reset
Standby Mode	<input type="radio"/> Off <input checked="" type="radio"/> Network Standby Mode <input type="radio"/> HDMI Standby Mode <input checked="" type="radio"/> 30 Minutes <input type="radio"/> 60 Minutes <input type="radio"/> 90 Minutes

Apply Cancel

The InstaShow Host will enter **Network Standby Mode** under the following conditions:

- The InstaShow Host has broadcast the Guide screen or Idle screen for the amount of time set in the **Standby Mode** field. In this circumstance the connected display will usually enter standby or power saving mode after a set period of time based on the configured settings for the display.

The InstaShow Host will wake up from **Network Standby Mode** under the following conditions:

- A wireless connection is made between the InstaShow Host and an InstaShow Button (the LEDs on both the InstaShow Host and InstaShow Button are lit up static blue).

HDMI Standby Mode, places the InstaShow Host in standby mode if there is no HDMI signal/ connection to the InstaShow Host for at least 10 minutes. When the InstaShow Host is in **HDMI Standby Mode** the LED will be off and power consumption will be less than 0.5W.

Advance Setting

Picture Quality Mode	<input checked="" type="radio"/> Presentation <input type="radio"/> Video <input type="radio"/> Low Power
Frame Rate	<input type="radio"/> High <input type="radio"/> Medium <input checked="" type="radio"/> Low
Screen Lock	<input type="radio"/> Enable <input checked="" type="radio"/> Disable
EDID Management	<input checked="" type="radio"/> On <input type="radio"/> Off <input type="radio"/> Reset
Standby Mode	<input type="radio"/> Off <input type="radio"/> Network Standby Mode <input checked="" type="radio"/> HDMI Standby Mode

Apply Cancel

The InstaShow Host will enter **HDMI Standby Mode** under either one of the following conditions:

- No HDMI cable connection is made between the InstaShow Host and a display for at least 10 minutes.
- The display which is connected to the InstaShow Host is powered off for at least 10 minutes.

The InstaShow Host will wake up from **HDMI Standby Mode** under either one of the following conditions:

- The display which is connected to the InstaShow Host is powered on.
- The power button on the InstaShow Host is pressed.
- The power cable connected to the InstaShow Host is disconnected then reconnected.



- In cases where users want to conserve energy, **Network Standby Mode** is a suitable mode as the power consumption for a display (e.g. projectors, TVs, monitors, etc.) is usually greater than the power consumption for the InstaShow Host (5V/1.5A).
- In cases where the InstaShow Host is attached to a ceiling or the power button is out of reach by the user, **HDMI Standby Mode** is a suitable mode as it allows the user to power off the InstaShow Host by powering off the display.

After you configure all the **Advance Setting** items, press **Apply** to proceed.

Advance Setting

Picture Quality Mode	<input checked="" type="radio"/> Presentation <input type="radio"/> Video <input type="radio"/> Low Power
Frame Rate	<input type="radio"/> High <input type="radio"/> Medium <input checked="" type="radio"/> Low
Screen Lock	<input type="radio"/> Enable <input checked="" type="radio"/> Disable
EDID Management	<input type="radio"/> On <input type="radio"/> Off <input checked="" type="radio"/> Reset
Standby Mode	<input type="radio"/> Off <input checked="" type="radio"/> Network Standby Mode <input type="radio"/> HDMI Standby Mode <input checked="" type="radio"/> 30 Minutes <input type="radio"/> 60 Minutes <input type="radio"/> 90 Minutes

Apply Cancel

If you want to restart the InstaShow Host, press **Restart** and a window will pop up. Press **OK** to proceed.

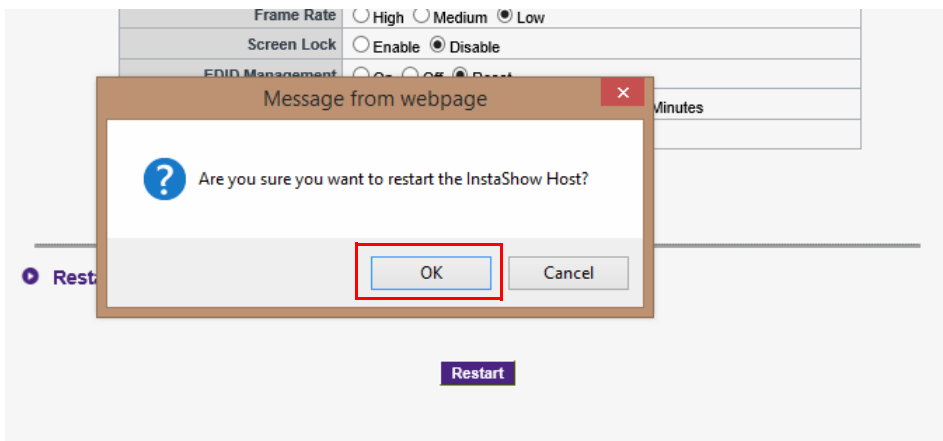

If you want to shutdown the InstaShow Host, press **Shutdown** and a window will pop up. Press **OK** to proceed.

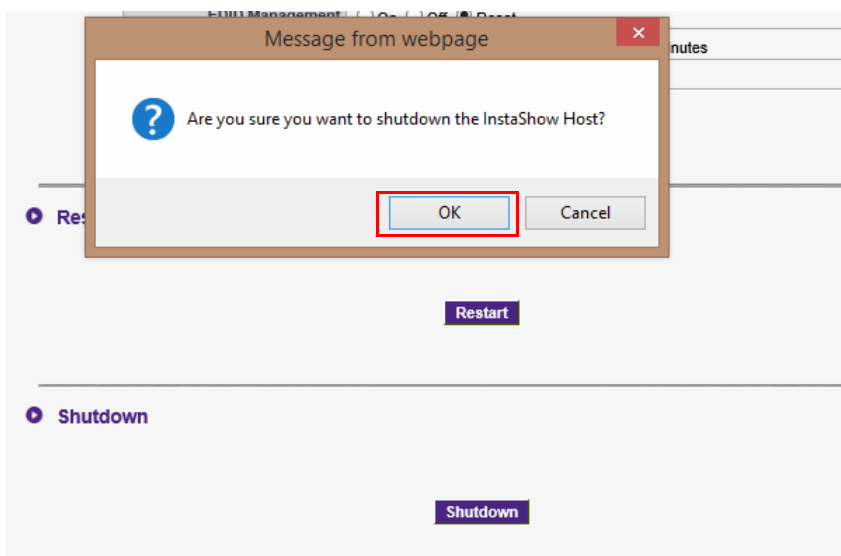

Scheduling

You can change the schedule by clicking **Scheduling**. You can set **System Time** and **Periodical Restart**.

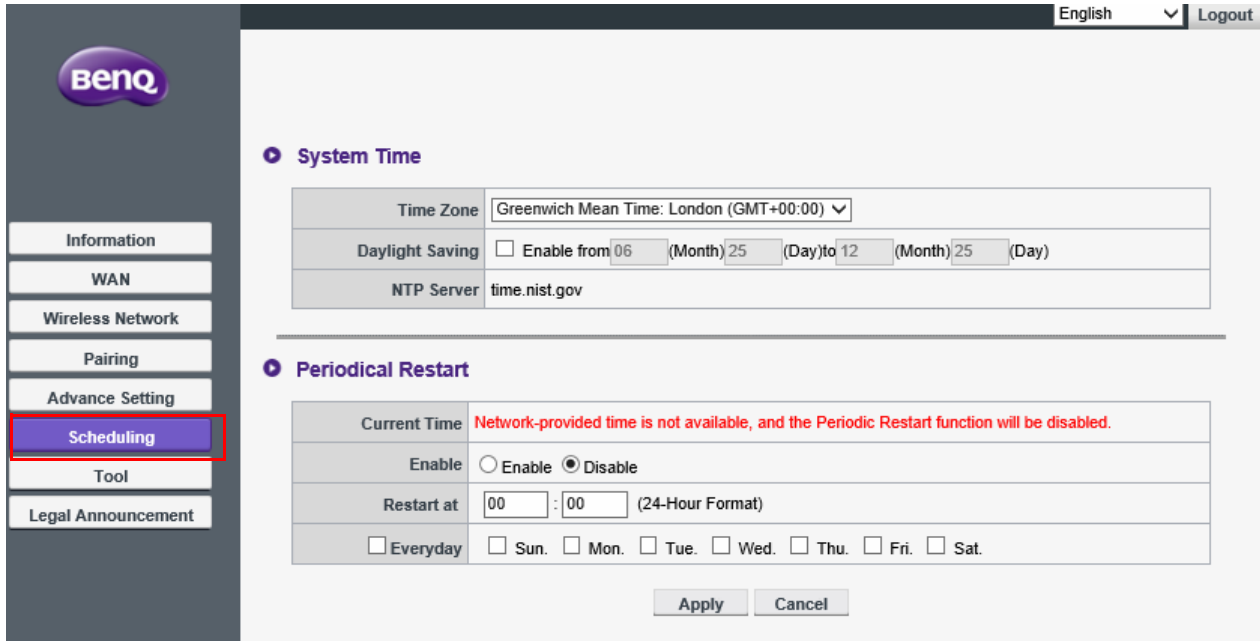

You can select your **Time Zone** and check **Enable** to set **Daylight Saving**.

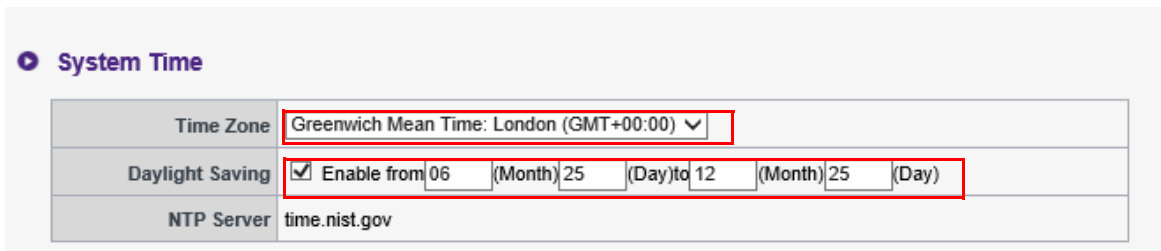

You can check **Enable** to set **Periodical Restart**. You can also set restart time and day.

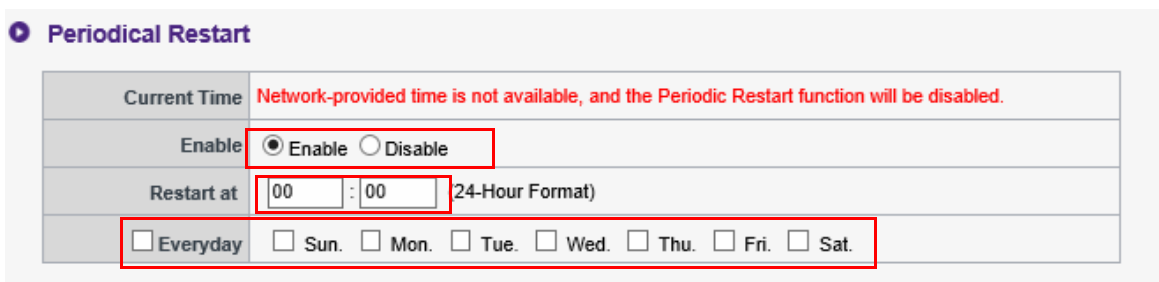

After you configure all the **Scheduling** settings, press **Apply** to proceed.

The screenshot shows the BenQ web management interface. On the left is a navigation menu with options: Information, WAN, Wireless Network, Pairing, Advance Setting, Scheduling (highlighted), Tool, and Legal Announcement. The main content area is titled 'System Time' and contains a table with the following fields:

Time Zone	Greenwich Mean Time: London (GMT+00:00) ▼
Daylight Saving	<input type="checkbox"/> Enable from 06 (Month) 25 (Day) to 12 (Month) 25 (Day)
NTP Server	time.nist.gov

Below this is the 'Periodical Restart' section with a table:

Current Time	Network-provided time is not available, and the Periodic Restart function will be disabled.
Enable	<input type="radio"/> Enable <input checked="" type="radio"/> Disable
Restart at	00 : 00 (24-Hour Format)
<input type="checkbox"/> Everyday	<input type="checkbox"/> Sun. <input type="checkbox"/> Mon. <input type="checkbox"/> Tue. <input type="checkbox"/> Wed. <input type="checkbox"/> Thu. <input type="checkbox"/> Fri. <input type="checkbox"/> Sat.

At the bottom of the Periodical Restart section are two buttons: 'Apply' (highlighted with a red box) and 'Cancel'.

Tool

By clicking **Tool**, you can adjust **Password Setup**, **Firmware Upgrade**, **Configuration Backup**, and **Log Setting**.

The screenshot shows the BenQ web management interface. On the left is a navigation menu with options: Information, WAN, Wireless Network, Pairing, Advance Setting, Scheduling, Tool (highlighted), and Legal Announcement. The 'Tool' menu is expanded, showing sub-options: Password Setup (highlighted), Firmware Upgrade, Configuration Backup, and Log Setting. The main content area is titled 'Password Setup' and contains a table with the following fields:

User Name	admin
Password	<input type="password"/>
New Password	<input type="password"/>
Confirm New Password	<input type="password"/>

At the bottom of the Password Setup section are two buttons: 'Apply' and 'Cancel'.

• Password Setup

You can change **Password** by:

1. Entering your old **Password**.
2. Entering your **New Password**.
3. Entering your **New Password** again to **Confirm New Password**.

4. Pressing **Apply** to proceed.

The screenshot shows a 'Password Setup' form with the following fields and controls:

User Name	admin
Password	<input type="password"/>
New Password	<input type="password"/>
Confirm New Password	<input type="password"/>

Below the form are two buttons: 'Apply' and 'Cancel'. Red boxes and arrows highlight the Password, New Password, Confirm New Password, and Apply buttons, labeled 1, 2, 3, and 4 respectively.

• **Firmware Upgrade/Driver Upgrade**

Before executing any **Firmware Upgrade/Driver Upgrade**, please contact your BenQ regional office for access to the upgrade files. Install the latest firmware and driver according to the following sequence:

1. Button_Driver_xxxx.bin
2. Host_Driver_xxx.bin
3. Button_Firmware_xxx.bin
4. Host_Firmware_xxx.bin



- Upgrades must follow the sequence listed above.
- Not every upgrade will require all of the 4 files listed above, if an upgrade file package features less than the 4 files above skip the missing file in the sequence.

You can change **Mode** to **Firmware Upgrade** or **Driver Upgrade**.

The screenshot shows the BenQ web management interface. The left sidebar contains a menu with 'Firmware Upgrade' highlighted. The main content area shows the 'Mode' section with radio buttons for 'Firmware Upgrade' (selected) and 'Driver Upgrade'. Below this is the 'InstaShow Host Firmware Upgrade' section, which includes a 'Browse...' button, a 'Firmware Upgrade' button, and a warning message:

Warning

1. Choosing the previous version of firmware will be reset to default setting.
2. Don't power off or press the reset button during the process of firmware upgrading.
3. Don't close the window during the process of Firmware upgrading.
4. Make sure the network not be occupied during the process of firmware upgrading.

Firmware Version : Firmware_Host_D1v1.00 (Feb 22 2016 10:15:42)

Below this is the 'InstaShow Button Firmware Upgrade' section, which includes a 'Browse...' button, the text 'Upgrade Selected InstaShow Button', and a 'Firmware Upgrade' button. A warning message is also present:

Warning

1. Don't power off or press the reset button during the process of firmware upgrading.
2. Don't close the window during the process of Firmware upgrading.

To upgrade the InstaShow Button Driver ensure that both the InstaShow Host and InstaShow Button are properly connected and the LEDs on both devices are static green, then follow the steps below:

1. Press **Browse** and choose the file to upgrade.
2. Choose the InstaShow Button that needs to be updated. Each InstaShow Button has a different Mac address, check the spec label and choose the Mac address of the InstaShow Button.



3. Press **Driver Upgrade** to proceed.

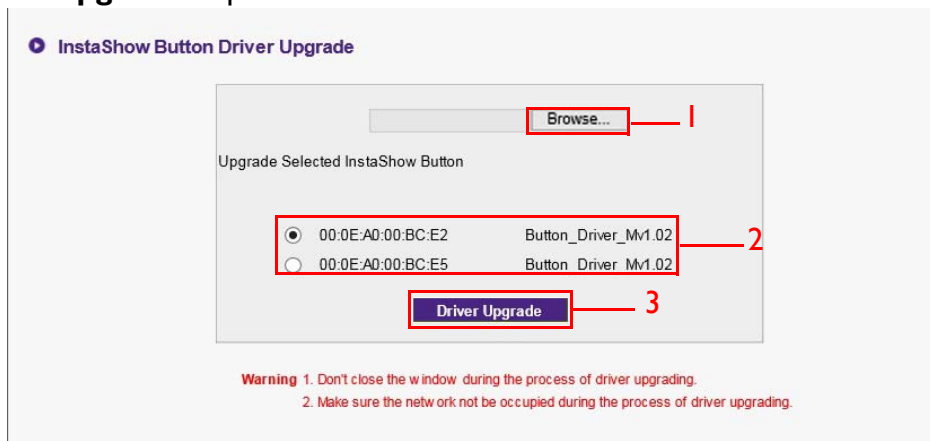

To upgrade the InstaShow Host Driver, ensure that both the InstaShow Host and InstaShow Button are properly connected and the LEDs on both devices are static green, then follow the steps below:

1. Press **Browse** and choose the file to upgrade.
2. Press **Driver Upgrade** to proceed.

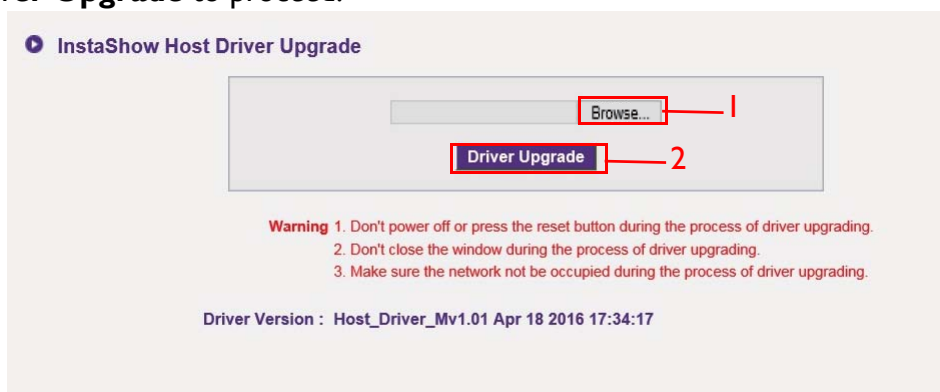

To upgrade the InstaShow Button firmware, ensure that both the InstaShow Host and InstaShow Button are properly connected and the LEDs on both devices are static green, then follow the steps below:

1. Press **Browse** and choose the file to upgrade.

- Choose the InstaShow Button that needs to be updated. Each InstaShow Button has a different Mac address, check the spec label and choose the Mac address of the InstaShow Button.



- Press **Firmware Upgrade** to proceed.

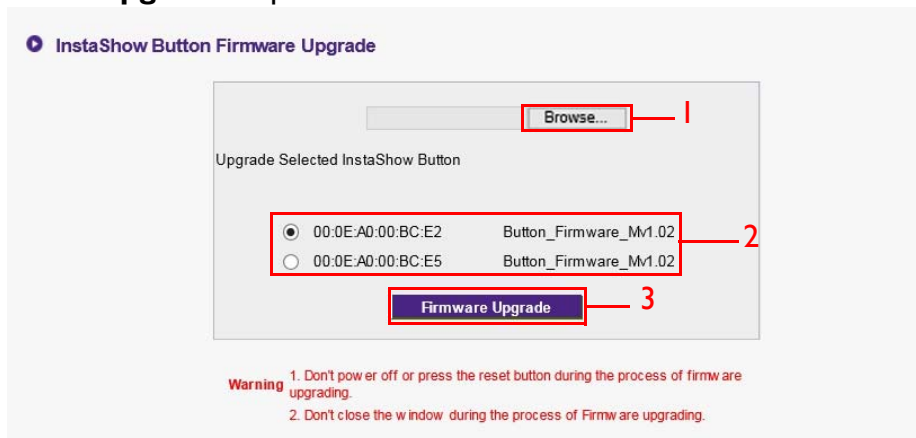

To upgrade the InstaShow Host firmware ensure that both the InstaShow Host and InstaShow Button are properly connected and the LEDs on both devices are static green, then follow the steps below:

- Press **Browse** and choose the file to upgrade.
- Press **Firmware Upgrade** to proceed.

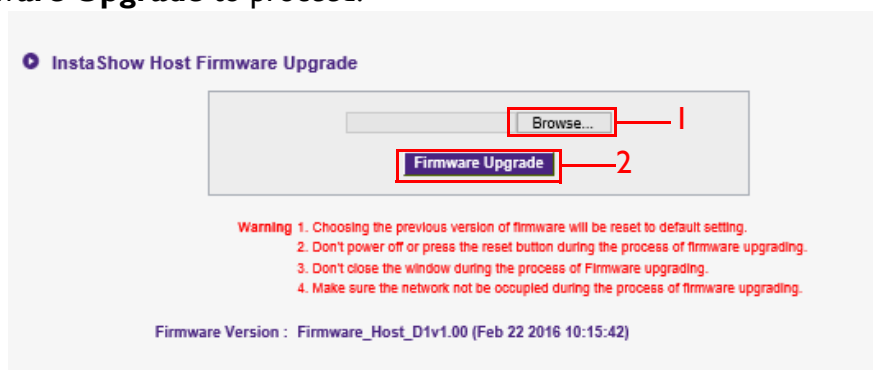

- When upgrading firmware/driver, follow the warning messages shown on the screen.
- Remember to upgrade all the InstaShow Buttons in the same room.
- When the device is upgrading its firmware/drivers, the LED on the device will flash green.
- Do not power off the device when the LED on the device is flashing green.

• Configuration Backup

Configuration backup files feature all the configuration settings for your InstaShow Host except for the host name, SSID and wireless password settings, and pairing status. In **Configuration Backup**, you can choose **Import Configuration File**, **Export Configuration File**, and **Factory Default**.

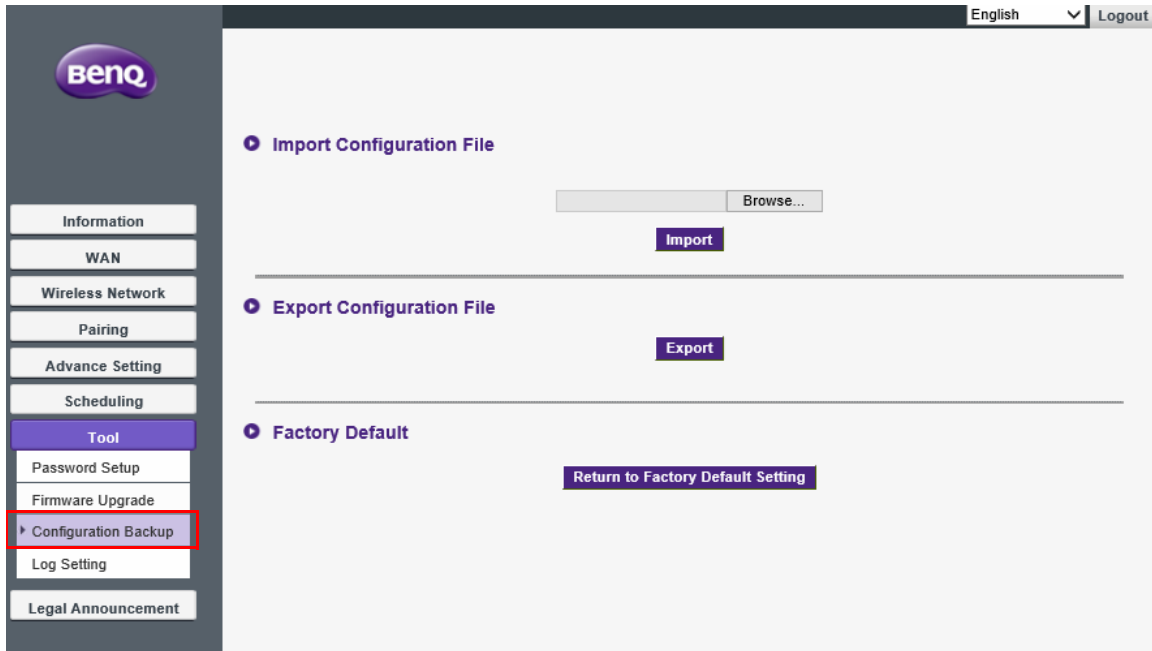

You can set **Import Configuration File** by:

1. Pressing **Browse** and choose the file to import.
2. Pressing **Import** to proceed.

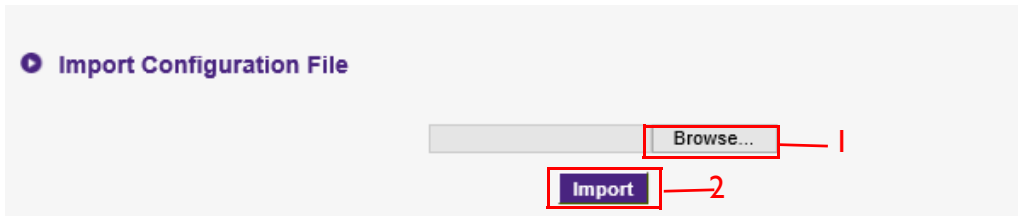

You can set **Export Configuration File** by:

1. Pressing **Export**.

2. Choosing **Open** or **Save** the .exp file.

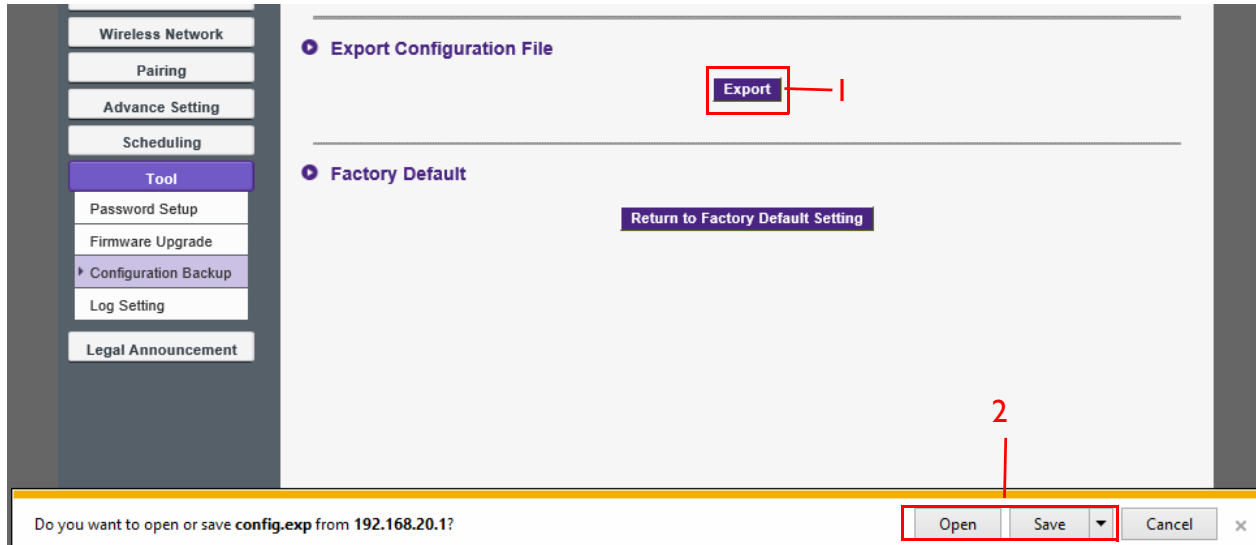

3. The following set values will not be exported:

a.	Information: Host Name
b.	Wireless Network: SSID setting and password setting
c.	Pairing: Pairing Status

You can have the InstaShow Host restore to **Factory Default** by pressing **Return to Factory Default Setting**. Once you press the **Return to Factory Default Setting** button, a confirmation window will pop up.

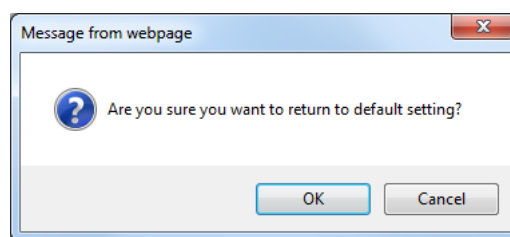

When the process is confirmed the InstaShow Host will begin restoring to **Factory Default** and the LED will quick flash red (flash red twice every second) then restart. After the InstaShow Host restarts the entire process is complete.

• Log Setting

Logs are records of all system activity for your InstaShow Host, which may be used by support technicians to track errors or locate bugs. In **Log Setting**, log can be set to **Save To Flash**, **Downloaded To PC**, and **Clear Log**.

a.	Save To Flash: On	Allow the InstaShow Host to save the current log into the flash memory. In other words, If the InstaShow Host restarts, the last log will be kept and can be exported by Downloaded To PC .
b.	Save To Flash: Off	If the InstaShow Host restarts, the last log will disappear and only the current log can be kept and available to be exported by Downloaded To PC .

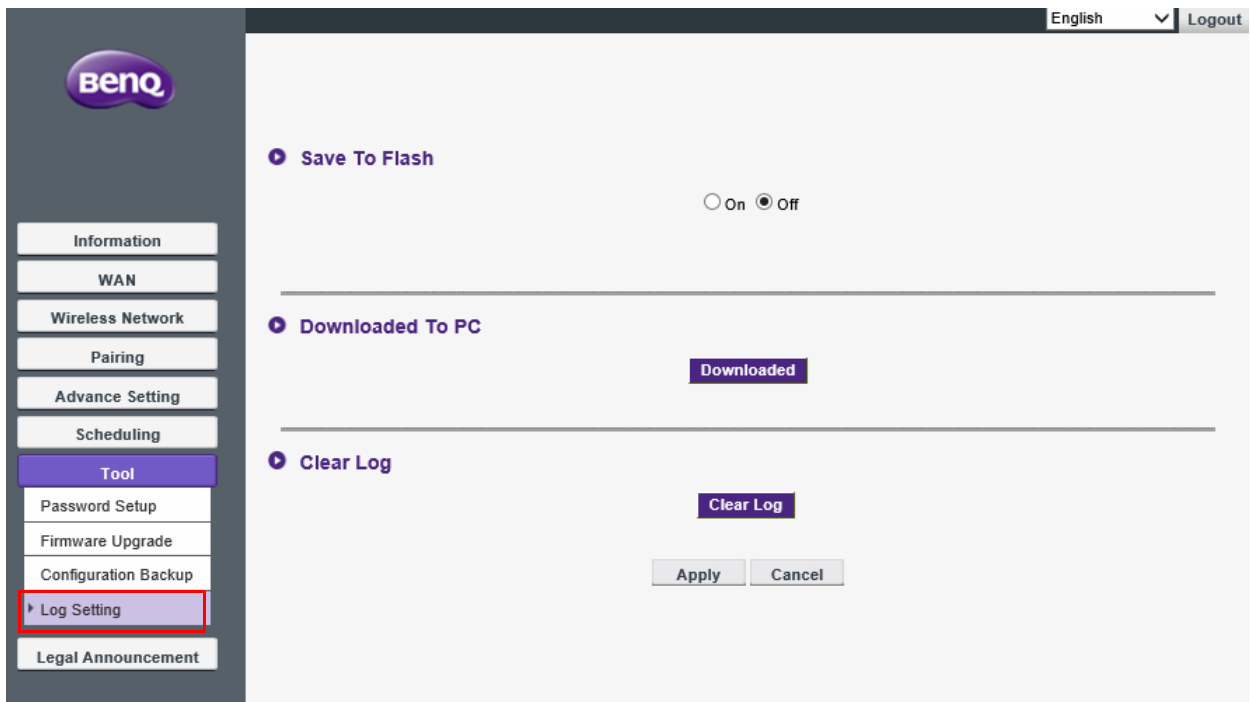

Legal Announcement

For information about disclaimer or privacy policy, press **Legal Announcement** to find out more.

Troubleshooting

Category	Problem	Cause	Solution
Your screen	Your screen is not appearing on the display when pressing the InstaShow Button.	The system is locked.	Web Management > Advanced Setting> Screen Lock > Disable
		The InstaShow Button is connecting to another InstaShow Host.	The InstaShow Button should be paired again with the InstaShow Host.
		Pressing time is not enough.	Press the Present key until the LED indicator turns from green to blue.
	The screen turns blank or flickers when the InstaShow Host is presenting (power connect through USB type A not guaranteed with 5V 1.5A).	Insufficient power supply	Change power supply of the InstaShow Host to a power adapter.
	The screen lags seriously and the audio breaks up sometimes.	Wi-Fi interference or signal attenuation	<ul style="list-style-type: none"> • Make sure the transmission distance is within 8M and with no obstacles. • Restart the InstaShow Host in order to rescan the Wi-Fi 5G channel. • Log in Web Management > Wireless Network > Wi-Fi Radio Setup > toggle the Rescan button.
	The message, "No Signal", from the InstaShow Host is shown on the display when the InstaShow Button is presenting, or your screen is blank gray.	The connection between your laptop and the InstaShow Button is loose.	Reconnect the USB-C™ cable of the InstaShow Button.
		Your laptop cannot detect the second monitor.	<ul style="list-style-type: none"> • Reconnect the USB-C™ cable of the InstaShow Button. • Reboot your laptop.

Category	Problem	Cause	Solution
Your screen	Your screen is shown, but your audio is not playing on the audio system of the meeting room.	The audio signal on your laptop is muted.	Right click on the speaker icon and switch off the mute.
		The audio output of the laptop hasn't been set to the second screen (BenQ InstaShow™) from the EDID of the InstaShow Button.	Change the default audio output to the second screen (BenQ InstaShow™) on the laptop.
The InstaShow Button	Your content is removed from the display and the LED indicator of your InstaShow Button is blinking red.	The wireless connection is lost between the InstaShow Button and InstaShow Host.	<ol style="list-style-type: none"> 1. The InstaShow Host will restore the Wi-Fi connection automatically. 2. If this fails, the LED indicator of your InstaShow Button starts blinking red. 3. Unplug the InstaShow Button from your laptop and try again.
		Wi-Fi interference or signal attenuation	Make sure the transmission distance is within 8M and with no obstacles.
	The LED indicator of the InstaShow Button is blinking red when the power is on.	The InstaShow Host has not been turned on.	Make sure InstaShow Host is turned on.
		The InstaShow Host has not paired with an InstaShow Button.	The InstaShow Host should pair with the InstaShow Button again.
		Wi-Fi interference or signal attenuation	Make sure the transmission distance is within 8M and with no obstacles.
	The LED indicator of the InstaShow Button is always off.	There is no power supply.	Check the USB-C™ port of your laptop. If the port fails to function, try other USB-C™ ports.
The InstaShow Button	The LED indicator on the InstaShow Button remains static red even after it has been powered on for 30 seconds.	The InstaShow Button has not been properly powered off during the resetting process	Reset the InstaShow Button.
	The pairing function cannot be executed via the MODE key while the InstaShow Button is powered on and the LED starts flashing red.		

Category	Problem	Cause	Solution
The InstaShow Host	Nothing is shown on the display at all.	The display is switched off.	Switch on the display.
		The wrong input is selected.	Select the correct input.
		The display cable is not connected properly.	Insert the HDMI cable between the InstaShow Host and the display device again.
		The display fails to show the InstaShow Host's output resolution at 720p in "Guide Screen" or "Idle Screen".	Replace the display with a new one that supports output resolution at 720p.
		The InstaShow Host is in Network Standby Mode when network standby function is enabled.	Press the Present key of the InstaShow Button to start presentation.
The InstaShow Host	Nothing is shown on the display at all.	The InstaShow Host is in HDMI Standby Mode when HDMI standby function is enabled.	Briefly press the power button on the InstaShow Host or power on the display (connected to the InstaShow Host with an HDMI cable). The InstaShow Host will wake up automatically.
		The InstaShow Host is powered off.	Briefly press the power button on the InstaShow Host.
		Insufficient power supply	Change power supply of InstaShow Host to a power adapter.
	The LED indicator on the InstaShow Host remains static red even after it has been powered on for 30 seconds.	The InstaShow Host has not been properly powered off during the resetting process	Reset the InstaShow Host.
EDID	After connecting the InstaShow Button to your laptop, the second screen (InstaShow™) cannot be detected.	The connection between your laptop and the InstaShow Button is loose.	Reconnect the USB-C™ cable of the InstaShow Button.
		Laptop problem	Reboot your laptop.
		The InstaShow Button is shutdown.	Reconnect the USB cable of the InstaShow Button.

Category	Problem	Cause	Solution
Pairing	The message, "Pairing failed", from the InstaShow Host is shown on the display when the InstaShow Host is pairing with the InstaShow Button.	1. Error: 004 2. The InstaShow Host has reached the maximum number of pairing.	Log into the web management, then select Pairing Status > Delete Delete unnecessary pairings.
		Wi-Fi interference or signal attenuation	Make sure the transmission distance is within 8M and with no obstacles.
		The InstaShow Button has not entered the pairing mode in time.	When the InstaShow Host enters pairing mode, the InstaShow Button should also enter pairing mode within two minutes.
Windows Software	When presenting a video file via Gom Media Player, the full-screen image is cut into upper and lower halves.	Media player	Use other media players to play video files, such as Windows Media Player.
Web management	Cannot Log in	Forget the account and password.	1. Reset the InstaShow Host. 2. The default log in account: admin 3. The default log in password: 0000.
	Laptop cannot connect the SSID with the correct password by Wi-Fi.	Laptop Wi-Fi module cannot support 802.11 AC.	Laptop can connect to the InstaShow Host with an Ethernet cable instead of Wi-Fi connection.