

Operating Manual

B 28

Incubators with mechanical adjustment

E 28

Drying and heating ovens with mechanical adjustment

Model	Model version	Art. no.
B 28	B028-230V	9010-0002, 9110-0002
B 28 with thermostat class 1	B028-230V-T	9010-0004, 9110-0004
B 28 (120 V)	B028-120V	9010-0067, 9110-0067
E 28	E028-230V	9010-0001, 9110-0001
E 28 with thermostat class 1	E028-230V-T	9010-0003, 9110-0003
E 28 (120 V)	E028-120V	9010-0106, 9110-0106

BINDER GmbH

- ▶ Address: Post office box 102, 78502 Tuttlingen, Germany ▶ Phone: +49 7462 2005 0
- ▶ Fax: +49 7462 2005 100 ▶ Internet: <http://www.binder-world.com>
- ▶ E-mail: info@binder-world.com ▶ Service Hotline: +49 7462 2005 555
- ▶ Service Fax: +49 7462 2005 93 555 ▶ Service E-Mail: service@binder-world.com
- ▶ Service Hotline USA: +1 866 885 9794 or +1 631 224 4340 x3
- ▶ Service Hotline Asia Pacific: +852 390 705 04 or +852 390 705 03
- ▶ Service Hotline Russia and CIS: +7 495 988 15 16

Content

1. SAFETY	4
1.1 Legal considerations	4
1.2 Structure of the safety instructions	4
1.2.1 Signal word panel	4
1.2.2 Safety alert symbol	5
1.2.3 Pictograms	5
1.2.4 Word message panel structure	6
1.3 Localization / position of safety labels on the chamber	6
1.4 Type plate	7
1.5 General safety instructions on installing and operating the chambers	8
1.6 Intended use	9
2. CHAMBER DESCRIPTION	10
2.1 B 28 chamber overview	11
2.2 E 28 chamber overview	11
2.3 Chamber rear	12
3. COMPLETENESS OF DELIVERY, TRANSPORTATION, STORAGE, AND INSTALLATION	12
3.1 Unpacking, and checking equipment and completeness of delivery	12
3.2 Guidelines for safe lifting and transportation	13
3.3 Storage	13
3.4 Location of installation and ambient conditions	13
4. INSTALLATION OF THE EQUIPMENT	15
4.1 Electrical connection	15
5. START UP	16
5.1 Turning on the chamber	16
5.1.1 Turning on the B 28 incubator by the main power switch	16
5.1.2 Turning on the E 28 drying and heating oven by the 0-120 minutes timer	16
5.2 Temperature setting	16
5.3 Fresh air supply	17
5.4 Using the E 28 for hot-air sterilization	17
6. TEMPERATURE SAFETY DEVICE CLASS 1 (OPTION)	17
7. MAINTENANCE, CLEANING, AND SERVICE	18
7.1 Maintenance intervals, service	18
7.2 Cleaning and decontamination	18
7.2.1 Cleaning	19
7.2.2 Decontamination	20
7.3 Sending the chamber back to BINDER GmbH	21
8. DISPOSAL	22
8.1 Disposal of the transport packing	22
8.2 Decommissioning	22
8.3 Disposal of the chamber in the Federal Republic of Germany	22
8.4 Disposal of the chamber in the member states of the EU except for the Federal Republic of Germany	23
8.5 Disposal of the chamber in non-member states of the EU	24



9.	TECHNICAL DESCRIPTION.....	25
9.1	Factory calibration and adjustment.....	25
9.2	Definition of usable volume.....	25
9.3	Over current protection	25
9.4	B 28 technical data.....	26
9.5	E 28 technical data.....	27
9.6	Equipment and Options (extract)	28
9.7	Accessories and spare parts (extract)	28
10.	CERTIFICATES AND DECLARATIONS OF CONFORMITY.....	29
10.1	EU Declaration of Conformity for B 28.....	29
10.2	EU Declaration of Conformity for E 28.....	31
11.	PRODUCT REGISTRATION	33
12.	CONTAMINATION CLEARANCE CERTIFICATE	34
12.1	For chambers located outside USA and Canada	34
12.2	For chambers in USA and Canada.....	37

Dear customer,

For the correct operation of the chambers, it is important that you read this operating manual completely and carefully and observe all instructions as indicated. Failure to read, understand and follow the instructions may result in personal injury. It can also lead to damage to the chamber and/or poor equipment performance.

1. Safety

This operating manual is part of the components of delivery. Always keep it handy for reference. The device should only be operated by laboratory personnel especially trained for this purpose and familiar with all precautionary measures required for working in a laboratory. Observe the national regulations on minimum age of laboratory personnel. To avoid injuries and damage observe the safety instructions of the operating manual.

	 WARNING
	<p>Failure to observe the safety instructions. Serious injuries and chamber damage.</p> <ul style="list-style-type: none"> ➤ Observe the safety instructions in this operating manual ➤ Carefully read the complete operating instructions of the chambers.

1.1 Legal considerations

This operating manual is for informational purposes only. It contains information for installing, start-up, operation and maintenance of the product. Note: the contents and the product described are subject to change without notice.

Understanding and observing the instructions in this operating manual are prerequisites for hazard-free use and safety during operation and maintenance. In no event shall BINDER be held liable for any damages, direct or incidental arising out of or related to the use of this manual.

This operating manual cannot cover all conceivable applications. If you would like additional information, or if special problems arise that are not sufficiently addressed in this manual, please ask your dealer or contact us directly by phone at the number located on page one of this manual

Furthermore, we emphasize that the contents of this operating manual are not part of an earlier or existing agreement, description, or legal relationship, nor do they modify such a relationship. All obligations on the part of BINDER derive from the respective purchase contract, which also contains the entire and exclusively valid statement of warranty administration. The statements in this manual neither augment nor restrict the contractual warranty provisions.

1.2 Structure of the safety instructions

In this operating manual, the following safety definitions and symbols indicate dangerous situations following the harmonization of ISO 3864-2 and ANSI Z535.6.

1.2.1 Signal word panel

Depending on the probability of serious consequences, potential dangers are identified with a signal word, the corresponding safety color, and if appropriate, the safety alert symbol.

 DANGER
<p>Indicates an imminently hazardous situation that, if not avoided, will result in death or serious (irreversible) injury.</p>

 **WARNING**

Indicates a potentially hazardous situation which, if not avoided, could result in death or serious (irreversible) injury

 **CAUTION**

Indicates a potentially hazardous situation which, if not avoided, may result in moderate or minor (reversible) injury

















CAUTION

Indicates a potentially hazardous situation which, if not avoided, may result in damage to the product and/or its functions or of a property in its proximity.

1.2.2 Safety alert symbol

-  Use of the safety alert symbol indicates a **risk of injury**.
- Observe all measures that are marked with the safety alert symbol in order to avoid death or injury.

1.2.3 Pictograms

Warning signs			
 Electrical hazard	 Hot surface	 Explosive atmosphere	 Stability hazard
 Risk of corrosion and / or chemical burns	 Harmful substances	 Biohazard	 Pollution Hazard
Mandatory action signs			
 Mandatory regulation	 Read operating instructions	 Disconnect the power plug	 Environment protection
 Wear protective gloves	 Wear safety goggles		
Prohibition signs			
 Do NOT touch	 Do NOT spray with water		



Information to be observed in order to ensure optimum function of the product.

1.2.4 Word message panel structure

Type / cause of hazard.

Possible consequences.

- ⊘ Instruction how to avoid the hazard: prohibition
- Instruction how to avoid the hazard: mandatory action

Observe all other notes and information not necessarily emphasized in the same way, in order to avoid disruptions that could result in direct or indirect injury or property damage.

1.3 Localization / position of safety labels on the chamber

The following labels are located on the chamber:



Pictograms (Warning signs)	Service label
 <p>Hot surface</p> <ul style="list-style-type: none"> • B 28: On the inner glass door next to the glass door handle • E 28: On the outer chamber door • E 28: On the chamber rear next to the exhaust duct 	 <p>Service - Hotline International: + 49 (0) 7462 / 2005-555 USA Toll Free: + 1 866 885 9794 or: + 1 631 224 4340 Россия и СНГ: + 7 495 98815 17 <small>serv.ce@binder-world.com www.binder-world.com</small> BINDER</p>



Figure 1: Position of labels on the chamber (example E 28)



Keep safety labels complete and legible.

Replace safety labels that are no longer legible. Contact BINDER Service for these replacements.

1.4 Type plate

The type plate is located at the bottom right on the left-hand side of the chamber.

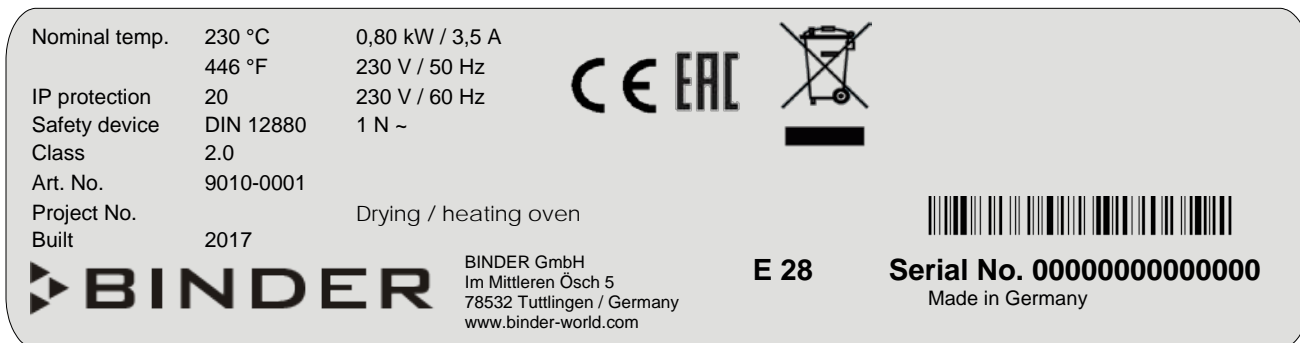





Figure 2: Type plate (example: E 28 regular chamber)

Indications of the type plate (example)		Information
BINDER		Manufacturer: BINDER GmbH
E 28		Model designation
Incubator		Chamber name: Incubator
Drying / heating oven		Chamber name: Drying and heating oven
Serial No.	000000000000	Serial No. of the chamber
Built	2017	Year of construction
Nominal temperature	230 °C 446 °F	Nominal temperature
IP protection	20	Type of IP protection acc. to standard EN 60529
Temp. safety device	DIN 12880	Temperature safety device acc. to standard DIN 12880:2007
Class	2.0	Class of temperature safety device
Art. No.	9010-0001	Art. no. of the chamber
Project No.	---	Optional: Special application acc. to project no.
0,80 kW		Nominal power
3,5 A		Nominal current
230 V / 50 Hz		Nominal voltage +/- 10% at the indicated power frequency
230 V / 60 Hz		
1 N ~		Current type

Symbol on the type plate	Information
	CE conformity marking
	Electrical and electronic equipment manufactured / placed on the market in the EC after 13 August 2005 and to be disposed of in a separate collection according to directive 2012/19/EU on waste electrical and electronic equipment (WEEE).
	The equipment is certified according to Customs Union Technical Regulation (CU TR) for the Eurasian Economic Union (Russia, Belarus, Armenia, Kazakhstan Kyrgyzstan).

1.5 General safety instructions on installing and operating the chambers



With regard to operating the chambers and to the installation location, please observe the DGUV guidelines 213-850 on safe working in laboratories (formerly BGI/GUV-I 850-0, BGR/GUV-R 120 or ZH 1/119, issued by the employers' liability insurance association) (for Germany).

BINDER GmbH is only responsible for the safety features of the chamber provided skilled electricians or qualified personnel authorized by BINDER perform all maintenance and repair, and if components relating to chamber safety are replaced in the event of failure with original spare parts.



To operate the chamber, use only original BINDER accessories or accessories from third-party suppliers authorized by BINDER. The user is responsible for any risk caused by using unauthorized accessories.

	CAUTION
	<p>Danger of overheating. Damage to the chamber.</p> <ul style="list-style-type: none"> ⊘ Do NOT install the chamber in unventilated recesses. ⊘ Do NOT cover the air exhaust slots on top of the housing. ➤ Ensure sufficient ventilation for dispersal of the heat.

Do not operate the chambers in hazardous locations.

	 DANGER
	<p>Explosion hazard. Danger of death.</p> <ul style="list-style-type: none"> ⊘ Do NOT operate the chamber in potentially explosive areas. ➤ KEEP explosive dust or air-solvent mixtures AWAY from the chamber.

The chambers do not dispose of any measures of explosion protection.

	 DANGER
	<p>Explosion hazard. Danger of death.</p> <ul style="list-style-type: none"> ⊘ Do NOT introduce any substance into the heating/drying oven which is combustible or explosive at working temperature ⊘ NO explosive dust or air-solvent mixture in the inner chamber.



Any solvent contained in the charging material must not be explosive or inflammable. I.e., irrespective of the solvent concentration in the steam room, NO explosive mixture with air must form. The temperature inside the chamber must lie below the flash point or below the sublimation point of the charging material. Familiarize yourself with the physical and chemical properties of the charging material, as well as the contained moisture constituent and its behavior with the addition of heat energy.

Familiarize yourself with any potential health risks caused by the charging material, the contained moisture constituent or by reaction products that may arise during the temperature process. Take adequate measures to exclude such risks prior to putting the chamber into operation.

	 DANGER
	<p>Electrical hazard.</p> <p>Danger of death.</p> <p>∅ The chamber must NOT become wet during operation or maintenance.</p>

The chambers were produced in accordance with the VDE regulations and were routinely tested in accordance to VDE 0411-1 (IEC 61010-1).

During and shortly after operation, the temperature of the inner surfaces almost equals the set-point.

	 CAUTION
	<p>The air exhaust slots on top of the housing, the inner chamber, the glass door and glass door handles (with B 28) become hot during operation.</p> <p>Danger of burning.</p> <p>∅ Do NOT touch the air exhaust slots on top of the housing, the glass door and glass door handles (with B 28), the inner surfaces, or the charging material during operation.</p>

1.6 Intended use

The chambers are suitable for exact tempering of harmless materials and for drying and heat treatment of solid or pulverized charging material, as well as bulk material, using the supply of heat. They can be used to dry e.g. glassware, and for warm storage of liquids in containers.

Because of their precise temperature accuracy the incubators B 28 are especially useful for incubation of cultures at a standard temperature of 37 °C / 98.6 °F.

A solvent content must not be explosive or flammable. A mixture of any component of the charging material with air must NOT be explosive. The operating temperature must lie below the flash point or below the sublimation point of the charging material. Any component of the charging material must NOT be able to release toxic gases.

Other applications are not approved.

The chambers are not classified as medical devices as defined by the Medical Device Directive 93/42/EEC.

Do NOT use the chamber for drying processes when large quantities of vapor would form and result in condensation.



	Due to the special demands of the Medical Device Directive 93/42/EEC, these ovens are not qualified for sterilization of medical devices as defined by the directive.
---	---

	Observing the instructions in this operating manual and conducting regular maintenance work (chap. 7) is part of the intended use.
---	--

	WARNING: If customer should use a BINDER chamber running in non-supervised continuous operation, we strongly recommend in case of inclusion of irrecoverable specimen or samples to split such specimen or samples and store them in at least two chambers, if this is feasible.
---	---

	The charging material shall not contain any corrosive ingredients that may damage the machine components. Such ingredients include in particular acids and halides. Any corrosive damage caused by such ingredients is excluded from liability by BINDER GmbH.
---	--

The chambers do not dispose of any measures of explosion protection.

 	 DANGER
	<p>Explosion or implosion hazard.</p> <p>Danger of poisoning.</p> <p>Danger of death.</p> <ul style="list-style-type: none"> ∅ Do NOT introduce any substance combustible or explosive at working temperature into the chamber, in particular no energy sources such as batteries or lithium-ion batteries. ∅ NO explosive dust or air-solvent mixture in the inner chamber. ∅ Do NOT introduce any substance which could lead to release of toxic gases.

In case of foreseeable use of the device there is no risk for the user through the integration of the chamber into systems or by special environmental or operating conditions in the sense of EN 61010-1:2010. For this, the intended use of the chamber and all its connections must be observed.

2. Chamber description

BINDER incubators B and drying and heating ovens E are heated electrically and are ventilated naturally.

The chambers are NOT regularly equipped with any temperature safety device consequently correspond to class 0 according to DIN 12880:2007. Operating is allowed under supervision only.

	CAUTION
	<p>Danger of overheating.</p> <p>Damage to the chamber.</p> <p>Damage to the charging material.</p> <ul style="list-style-type: none"> ∅ Do NOT operate an unsupervised chamber. ➤ Operate the chamber under supervision only.

The chambers can be optionally equipped with a temperature safety device class 1.0 according to DIN12880:2007 (chap. 6).

The inner chamber, the pre-heating chamber and the interior side of the doors are all made of stainless steel V2A (German material no. 1.4301, US equivalent AISI 304). The housing is RAL 7035 powder-coated. All corners and edges are also completely coated.

All chamber functions are easy and comfortable to use thanks to their clear arrangement. Major features are easy cleaning of all chamber parts and avoidance of undesired contamination.

Drying and heating ovens E: When operating the chambers at temperatures above 150 °C, the impact of the oxygen in the air may cause discoloration of the metallic surfaces (yellowish-brown or blue) by natural oxidation processes. These colorations are harmless and will in no way impair the function or quality of the chamber.

Temperature range at an ambient temperature of +18 °C to +40 °C / 64.4 °F to 104 °F:

- Incubators B: Setting range 30 °C / 86 °F up to 70 °C / 158 °F, control range by 5° above room temperature up to 70 °C / 158 °F.
- Drying and heating ovens E: 60 °C / 140 °F up to 230 °C / 446 °F.

2.1 B 28 chamber overview

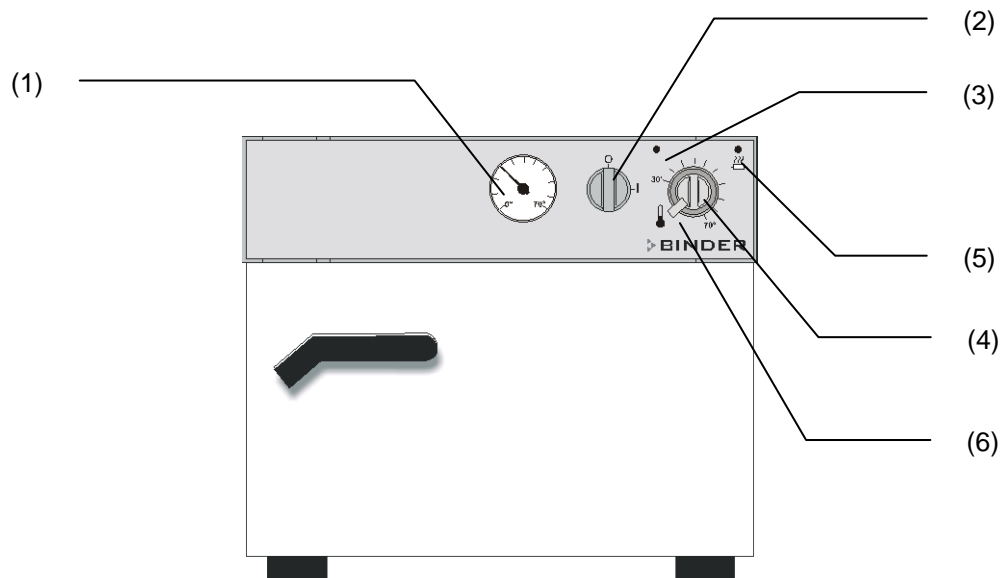

Figure 3: Incubator B 28

- | | |
|---|--|
| (1) Control thermometer | (4) Thermostat |
| (2) Main power switch | (5) Pilot lamp yellow (heating active) |
| (3) Pilot lamp green (ready to operate) | (6) Thermostat brake |

2.2 E 28 chamber overview

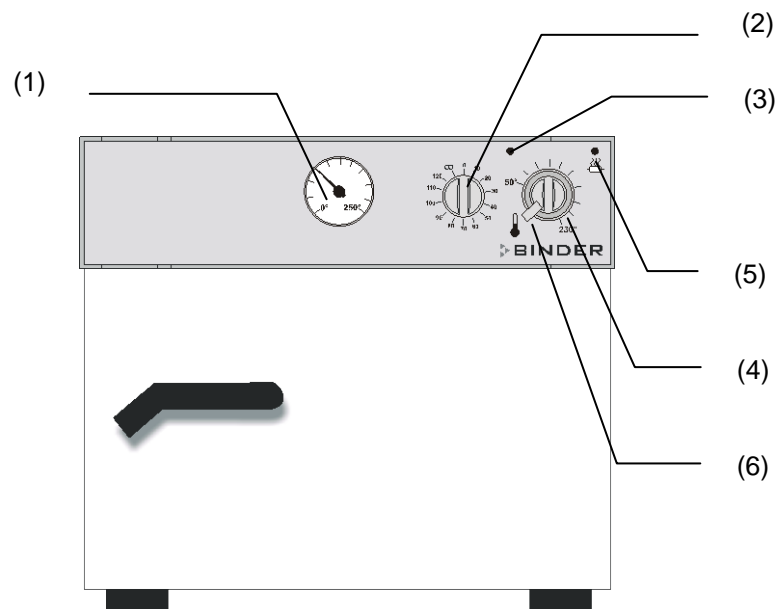

Figure 4: Drying and heating oven E 28

- | |
|--|
| (1) Control thermometer |
| (2) Timer 0-120 minutes (also main power switch) |
| (3) Pilot lamp green (ready to operate) |
| (4) Thermostat |
| (5) Pilot lamp yellow (heating active) |
| (6) Thermostat brake |

2.3 Chamber rear

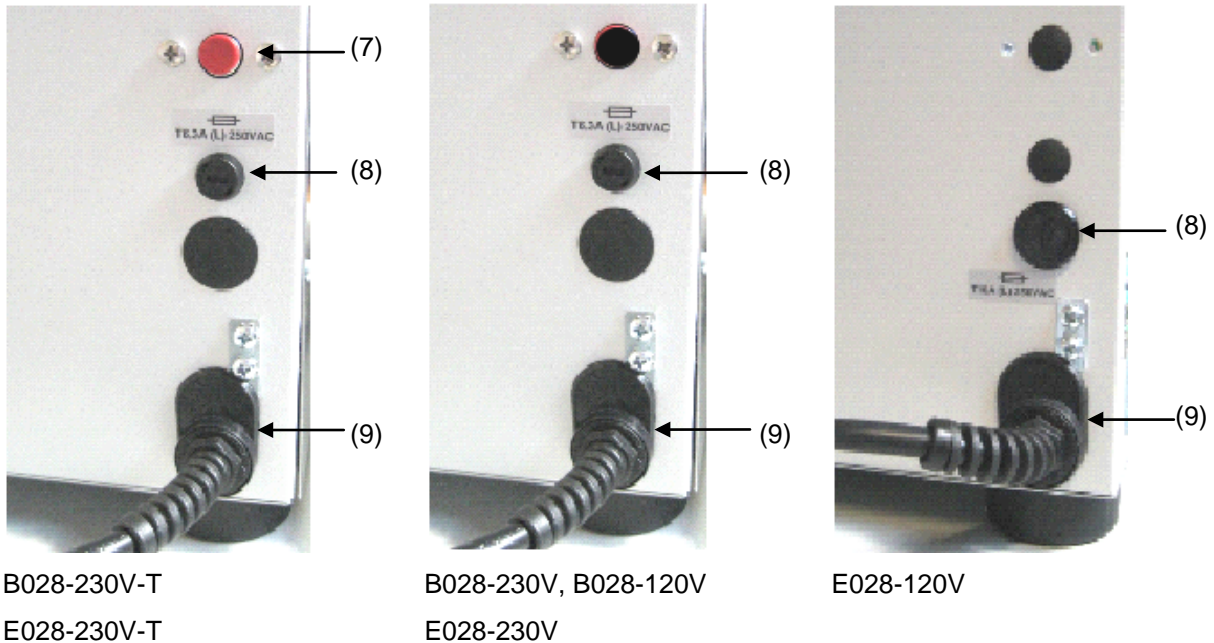

Figure 5: B 28 and E 28 chamber rear

- (7) Temperature safety device class 1
- (8) Chamber fuse
- (9) Power cable



3. Completeness of delivery, transportation, storage, and installation

3.1 Unpacking, and checking equipment and completeness of delivery

After unpacking, please check the chamber and its optional accessories, if any, based on the delivery receipt for completeness and for transportation damage. Inform the carrier immediately if transportation damage has occurred.

The final tests of the manufacturer may have caused traces of the shelves on the inner surfaces. This has no impact on the function and performance of the chamber.

Please remove any transportation protection devices and adhesives in/on the chamber and on the doors and remove the operating manuals and accessory equipment.

 	CAUTION
	<p>Sliding or tilting of the chamber. Damage to the chamber.</p> <ul style="list-style-type: none"> ∅ Do NOT lift or transport the chamber using the door or the handle. ➤ Lift the chamber at the four lower corners with the aid of 2 people.

If you need to return the chamber, please use the original packing and observe the guidelines for safe lifting and transportation (chap. 3.2).

For disposal of the transport packing, see chap. 8.1.



Note on second-hand chambers (Ex-Demo-Units):

Second-hand chambers are chambers that were used for a short time for tests or exhibitions. They are thoroughly tested before resale. BINDER ensures that the chamber is technically sound and will work flawlessly.

Second-hand chambers are marked with a sticker on the chamber door. Please remove the sticker before commissioning the chamber.

3.2 Guidelines for safe lifting and transportation

After operation, please observe the guidelines for temporarily decommissioning the chamber (chap. 8.2).

 	CAUTION
	<p>Sliding or tilting of the chamber. Damage to the chamber.</p> <ul style="list-style-type: none"> ➤ Transport the chamber in its original packaging only. ➤ For moving or shipping, secure the oven with transport straps. ⊘ Do NOT lift or transport the chamber using the door or the handle. ➤ Lift the chamber at the four lower corners with the aid of 2 people.

- Permissible ambient temperature range during transport: -10 °C up to +60 °C / 14 °F up to 140 °F.

You can order transport packing and pallets for moving or shipping purposes from BINDER Service.

3.3 Storage

Intermediate storage of the chamber is possible in a closed and dry room. Observe the guidelines for temporary decommissioning (chap. 8.2).

- Permissible ambient temperature range during storage: -10 °C up to +60 °C / 14 °F up to 140 °F.
- Permissible ambient humidity: max. 70 % r.H., non-condensing

When after storage in a cold location you transfer the chamber to its warmer installation site, condensation may form. Before start-up, wait at least one hour until the chamber has attained ambient temperature and is completely dry.

3.4 Location of installation and ambient conditions

Set up the chamber on an even and non-flammable surface, free from vibration and in a well-ventilated, dry location and align it using a spirit level. The site of installation must be capable of supporting the chamber's weight (see technical data, chap. 9.3 and 9.4). The chambers are designed for setting up inside a building (indoor use).

	CAUTION
	<p>Danger of overheating. Damage to the chamber.</p> <ul style="list-style-type: none"> ⊘ Do NOT set up chambers in non-ventilated recesses. ➤ Ensure sufficient ventilation for dispersal of the heat.

- Permissible ambient temperature range during operation: +18 °C up to +40 °C / 64.4 °F up to 104 °F. At elevated ambient temperature values, fluctuations in temperature can occur.



The ambient temperature should not be substantially higher than the indicated ambient temperature of +22 °C +/- 3 °C / 71.6 °F ± 5.4 °F to which the specified technical data relate. Deviations from the indicated data are possible for other ambient conditions.

- Permissible ambient humidity: 70 % r.H. max., non-condensing.
- Installation height: max. 2000 m / 6562 ft. above sea level.



When placing several chambers of the same size side by side, maintain a minimum distance of 250 mm / 9.84 in between each chamber. Wall distances: rear 100 mm / 3.94 in, sides 160 mm / 6.29 in. Spacing above the chamber of at least 100 mm / 3.94 in must also be maintained.

The devices are not suitable for stacking.

To completely separate the chamber from the power supply, you must disconnect the power plug. Install the chamber in a way that the power plug is easily accessible and can be easily pulled in case of danger.

For the user there is no risk of temporary overvoltages in the sense of EN 61010-1:2010.

Do not install or operate the chamber in hazardous locations.

	 DANGER
	<p>Explosion hazard.</p> <p>Danger of death.</p> <ul style="list-style-type: none"> ⊘ Do NOT operate the chamber in potentially explosive areas. ➤ KEEP explosive dust or air-solvent mixtures AWAY from the vicinity of the chamber.

4. Installation of the equipment

4.1 Electrical connection

The chambers are supplied ready for connection. They come with a fixed power connection cable of at least 1800 mm / 70.87 in in length.

Model	Power plug	Nominal voltage +/- 10% at the indicated power frequency	Current type
B 28 E 28	Shockproof plug	230 V at 50 Hz 230 V at 60 Hz	1N~
B 28 (120 V) E 28 (120 V)	NEMA 5-15P	115 V at 60 Hz	1N~

- The domestic socket must also provide a protective conductor. Make sure that the connection of the protective conductor of the domestic installations to the chamber's protective conductor meets the latest technology. The protective conductors of the socket and plug must be compatible!
- Prior to connection and start-up, check the power supply voltage. Compare the values to the specified data located on the chamber's type plate (on the left-hand side of the chamber, see chap. 1.4).
- When connecting, please observe the regulations specified by the local electricity supply company as well as the VDE directives (for Germany). We recommend the use of a residual current circuit breaker.
- Pollution degree (acc. to IEC 61010-1): 2
- Over-voltage category (acc. to IEC 61010-1): II

	CAUTION
	<p>Danger of incorrect power supply voltage.</p> <p>Damage to the equipment.</p> <ul style="list-style-type: none"> ➤ Check the power supply voltage before connection and start-up. ➤ Compare the power supply voltage with the data indicated on the type plate.

See also electrical data (chap. 9.3 and 9.4).

	<p>To completely separate the chamber from the power supply, you must disconnect the power plug. Install the chamber in a way that the power plug is easily accessible and can be easily pulled in case of danger.</p>
---	--

5. Start up

5.1 Turning on the chamber

Warming chambers may release odors in the first few days after commissioning. This is not a quality defect. To reduce odors quickly we recommend heating up the chamber to its nominal temperature for one day and in a well-ventilated location.

5.1.1 Turning on the B 28 incubator by the main power switch

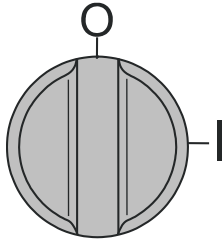

Figure 6: Main power switch ON/OFF (B 28)

Set the main power switch (2) to position I. The green pilot lamp (3) shows the chamber is ready for operation.

5.1.2 Turning on the E 28 drying and heating oven by the 0-120 minutes timer

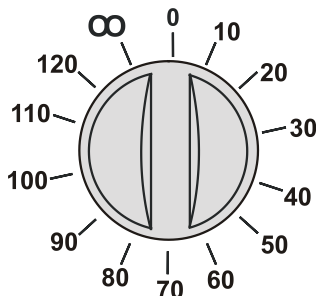

Figure 7: Timer 0-120 minutes (E 28)

In the zero-position (0) the heating is permanently deactivated.

When you turn the timer counter-clockwise up to position (∞), the chamber will work in continuous operating mode, i.e. the heating will operate permanently. The green pilot lamp (3) shows the chamber is operating.

Set the operating time for the heating by turning the timer clockwise. The green pilot lamp (3) shows the chamber is operating. When the time expires, the heating will turn off automatically. The pilot lamp (3) light will go out.

5.2 Temperature setting

The adjustment of the temperature level is identical for E and B. The temperature controllers only differ in the temperature range:

Set the thermostat knob (4) to the desired temperature. Lock it by turning the thermostat brake (6).

Illumination of the yellow pilot lamp (5) indicates that the heating is on. When the working temperature is reached, the yellow pilot lamp flashes indicating operation of the thermostat.



To ensure exact temperature control, always set the temperature by turning the thermostat knob (4) clockwise. Before setting any temperature, turn the thermostat knob back to the left stop.

5.3 Fresh air supply

Use the ventilation slide inside the chamber on top at the ceiling to adjust fresh air supply.

If the ventilation slide is completely open, this may negatively influence the spatial temperature accuracy, which may decrease by up to 5 %.

The air exhaust slots on top of the housing become hot during operation. Do not cover them.

	CAUTION
	<p>Danger of overheating.</p> <p>Damage to the chamber.</p> <ul style="list-style-type: none"> Ø Do NOT touch the air exhaust slots on top of the housing during operation. Ø Do NOT cover the air exhaust slots on top of the housing.

5.4 Using the E 28 for hot-air sterilization

Sterilizing load: Instruments, glass and glass instruments, syringes (no synthetic material or surgical cotton wool).

Sterilizing temperature: 180 °C / 356 °F.

Sterilizing time: Unless laid down by special organizations of your country, we recommend 30 minutes after reaching the sterilizing temperature. When using sterilizing boxes, the sterilizing time must be increased by another 15 - 30 minutes.

	<p>Due to the special demands of the Medical Device Directive (MDD), these ovens are not qualified for sterilization of medical devices as defined by directive 93/42/EWG.</p>
---	--

6. Temperature safety device class 1 (option)

The chamber can be optionally equipped with a temperature safety device class 1 acc. to DIN 12880. It serves to protect the chamber and prevents dangerous conditions caused by major defects.

	<p>This option permits unsupervised operating of the device.</p>
---	--



If the nominal temperature is exceeded by about 25 degrees, the over temperature protective device permanently turns off the chamber.

When the chamber has cooled down, you can turn on the heating by pressing the reset button at the back of the chamber. If the heating elements turn off repeatedly, have a specialist investigate and remove the reason of the failure. The reset button is located on the chamber rear, at the bottom right side.

	<p>If the temperature safety device acts repeatedly, please contact an authorized service or BINDER Service.</p>
---	--

7. Maintenance, cleaning, and service

7.1 Maintenance intervals, service

 	 DANGER
	<p>Electrical hazard. Danger of death.</p> <ul style="list-style-type: none"> ∅ The chamber must NOT become wet during operation or maintenance work. ∅ Do NOT remove the rear panel of the chamber. ➤ Before conducting maintenance work, turn off the chamber at the main power switch (B 28) or with the timer (E 28) and disconnect the power plug. ➤ Ensure all maintenance work is conducted by licensed electricians or experts authorized by BINDER.

Ensure regular maintenance work is performed at least once a year.

	The warranty becomes void if maintenance work is conducted by non-authorized personnel.
---	---

	Replace the door gasket only when cold. Otherwise, the door gasket may become damaged.
--	--





We recommend taking out a maintenance agreement. Please consult BINDER Service.

BINDER telephone hotline:	+49 (0) 7462 2005 555
BINDER fax hotline:	+49 (0) 7462 2005 93555
BINDER e-mail hotline:	service@binder-world.com
BINDER service hotline USA:	+1 866 885 9794 or +1 631 224 4340 (toll-free in the USA) x3
BINDER service hotline Asia Pacific:	+852 390 705 04 or +852 390 705 03
BINDER service hotline Russia and CIS	+7 495 988 15 16
BINDER Internet website	http://www.binder-world.com
BINDER address	BINDER GmbH, post office box 102, 78502 Tuttlingen, Germany

International customers, please contact your local BINDER distributor.

7.2 Cleaning and decontamination

Clean the chamber after each use to avoid potential corrosion damage by ingredients of the test material.

  	 DANGER
	<p>Electrical hazard. Danger of death.</p> <ul style="list-style-type: none"> ∅ Do NOT spill water or cleaning agents over the inner and outer surfaces. ➤ Before cleaning, turn off the chamber and disconnect the power plug. ➤ Completely dry the appliance before turning it on again.

7.2.1 Cleaning

Disconnect the chamber from the power supply before cleaning. Pull the power plug.

	<p>The interior of the chamber must be kept clean. Thoroughly remove any residues of the charging material.</p>
---	---

Wipe the surfaces with a moistened towel. In addition, you can use the following cleaning agents:

<p>Exterior surfaces inner chamber racks door gaskets</p>	<p>Standard commercial cleaning detergents free from acid or halides. Alcohol based solutions. We recommend using the neutral cleaning agent Art. No. 1002-0016.</p>
<p>Instrument panel</p>	<p>Standard commercial cleaning detergents free from acid or halides. We recommend using the neutral cleaning agent Art. No. 1002-0016.</p>
<p>Zinc coated hinge parts rear chamber wall</p>	<p>Standard commercial cleaning detergents free from acid or halides. Do NOT use a neutral cleaning agent on zinc coated surfaces.</p>

Do not use cleaning agents that may cause a hazard due to reaction with components of the device or the charging material. If there is doubt regarding the suitability of cleaning products, please contact BINDER service.

	<p>We recommend using the neutral cleaning agent Art. No. Art. Nr. 1002-0016 for a thorough cleaning.</p> <p>Any corrosive damage that may arise following use of other cleaning agents is excluded from liability by BINDER GmbH.</p> <p>Any corrosive damage caused by a lack of cleaning, is excluded from liability by BINDER GmbH.</p>
---	---

	<p style="text-align: center;">CAUTION</p> <p>Danger of corrosion.</p> <p>Damage to the chamber.</p> <ul style="list-style-type: none"> ⊘ Do NOT use acidic or chlorine cleaning detergents. ⊘ Do NOT use a neutral cleaning agent on other kind of surfaces e.g., the zinc coated hinge parts or the rear chamber wall.
---	---

	<p>For surface protection, perform cleaning as quickly as possible.</p> <p>After cleaning, completely remove cleaning agents from the surfaces with a moistened towel. Let the chamber dry.</p>
---	---





	<p>Soapsuds may contain chlorides and must therefore NOT be used for cleaning.</p>
---	--

	<p>With every decontamination method, always use adequate personal safety controls.</p>
---	---

Following cleaning, leave the chamber door open or remove the access port plugs.

	<p>The neutral cleaning agent may cause health problems in contact with skin and if ingested. Follow the operating instructions and safety hints labeled on the bottle of the neutral cleaning agent.</p>
---	---

Recommended precautions: To protect the eyes use sealed protective goggles. Suitable protective gloves with full contact: butyl or nitrile rubber, penetration time >480 minutes.

	<table border="1"> <tr> <td data-bbox="852 488 927 555">  </td> <td data-bbox="943 497 1114 533"> CAUTION </td> </tr> <tr> <td colspan="2"> <p>Contact with skin, ingestion.</p> <p>Skin and eye damage due to chemical burns.</p> <ul style="list-style-type: none"> Ø Do not ingest. Keep away from food and beverages. Ø Do NOT empty into drains. ➤ Wear protective gloves and goggles. ➤ Avoid skin contact. </td> </tr> </table>		CAUTION	<p>Contact with skin, ingestion.</p> <p>Skin and eye damage due to chemical burns.</p> <ul style="list-style-type: none"> Ø Do not ingest. Keep away from food and beverages. Ø Do NOT empty into drains. ➤ Wear protective gloves and goggles. ➤ Avoid skin contact. 	
	CAUTION				
<p>Contact with skin, ingestion.</p> <p>Skin and eye damage due to chemical burns.</p> <ul style="list-style-type: none"> Ø Do not ingest. Keep away from food and beverages. Ø Do NOT empty into drains. ➤ Wear protective gloves and goggles. ➤ Avoid skin contact. 					

7.2.2 Decontamination

The operator must ensure that proper decontamination is performed in case a contamination of the chamber by hazardous substances has occurred.

Disconnect the chamber from the power supply prior to chemical decontamination. Pull the power plug.

Do not use decontamination agents that may cause a hazard due to reaction with components of the device or the charging material. If there is doubt regarding the suitability of cleaning products, please contact BINDER service.

You can use the following disinfectants:

<p>Inner chamber</p>	<p>Standard commercial surface disinfectants free from acid or halides. Alcohol-based solutions. We recommend using the disinfectant spray Art. No. 1002-0022.</p>
----------------------	--

	<p>For chemical disinfection, we recommend using the disinfectant spray Art. No. 1002-0022. Any corrosive damage that may arise following use of other disinfectants is excluded from liability by BINDER GmbH.</p>
---	---



	<p>With every decontamination method, always use adequate personal safety controls.</p>
---	---

In case of impurity of the interior with biological or chemical hazardous goods, there are three possible procedures depending on the type of contamination and of the charging material.

- (1) The drying and heating ovens E can be hot air sterilized at 190 °C / 374 °F for at least 30 minutes. All inflammable goods must be removed from the interior before.
- (2) Spray the inner chamber with an appropriate disinfectant.
Before start-up, the chamber must be absolute dry and ventilated, because explosive gases may form during the decontamination process.
- (3) If necessary, have strongly contaminated inner chamber parts removed by an engineer for cleaning, or have them exchanged. Sterilize the inner chamber parts in a sterilizer or autoclave.

	<p>In case of eye contact, the disinfectant spray may cause eye damage due to chemical burns. Follow the operating instructions and safety hints labeled on the bottle of the disinfectant spray.</p>
---	---

Recommended precautions: To protect the eyes use sealed protective goggles.

	 CAUTION
<p>Eye contact. Eye damage due to chemical burns.</p> <ul style="list-style-type: none"> ⊘ Do NOT empty into drains. ➤ Wear protective goggles. 	

	<p>After using the disinfectant spray, allow the chamber to dry thoroughly, and aerate it sufficiently.</p>
---	---

7.3 Sending the chamber back to BINDER GmbH

If you return a BINDER product to us for repair or any other reason, we will only accept the product upon presentation of an **authorization number** (RMA number) that has previously been issued to you. An authorization number will be issued after receiving your complaint either in writing or by telephone **prior** to your sending the BINDER product back to us. The authorization number will be issued following receipt of the information below:

- BINDER product type and serial number
- Date of purchase
- Name and address of the dealer from which you bought the BINDER product
- Exact description of the defect or fault
- Complete address, contact person and availability of that person
- Exact location of the BINDER product in your facility
- A contamination clearance certificate (chap. 10) must be faxed in advance

The authorization number must be applied to the packaging in such a way that it can be easily recognized or be recorded clearly in the delivery documents.

	<p>For security reasons we cannot accept a chamber delivery if it does not carry an authorization number.</p>
---	---

Return address: BINDER GmbH Gänsäcker 16
Abteilung Service 78502 Tuttlingen, Germany

8. Disposal

8.1 Disposal of the transport packing

Packing element	Material	Disposal
Straps to fix packing on pallet	Plastic	Plastic recycling
Transport box with metal clamps	Cardboard	Paper recycling
	Metal	Metal recycling
Edge protection	Styropor®	Plastic recycling
Protection of doors and racks	PE foam	Plastic recycling
Bag for operating manual	PE foil	Plastic recycling
Insulating air cushion foil (packing of optional accessories)	PE foil	Plastic recycling

If recycling is impossible, all packing parts can also be disposed of with normal waste.

8.2 Decommissioning

Turn off the main power switch (2). Disconnect the chamber from the power supply.



When turning off the main power switch ON / OFF (2), the stored parameters remain saved.

- Temporal decommissioning: See indications for appropriate storage, chap. 3.3.
- Final decommissioning: Dispose of the chamber as described in chap. 8.3 to 8.5.

8.3 Disposal of the chamber in the Federal Republic of Germany

According to Annex I of Directive 2012/19/EU of the European Parliament and of the Council on waste electrical and electronic equipment (WEEE), BINDER devices are classified as “monitoring and control instruments” (category 9) only intended for professional use“. They must not be disposed of at public collecting points.

The chambers bear the symbol for the marking of electrical and electronic equipment manufactured / placed on the market in the EU after 13 August 2005 and be disposed of in separate collection according to Directive 2012/19/EU on waste electrical and electronic equipment (WEEE) and German national law for electrical and electronic equipment (Elektro- und Elektronikgerätegesetz, ElektroG). WEEE marking: crossed-out wheeled bin with solid bar under. A significant part of the materials must be recycled in order to protect the environment.

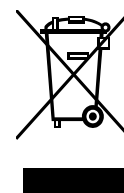



At the end of the device's service life, have the device disposed of according to the German national law for electrical and electronic equipment (Elektro- und Elektronikgerätegesetz, ElektroG from 20 October 2015, BGBl. I p. 1739) or contact BINDER service who will organize taking back and disposal of the chamber according to the German national law for electrical and electronic equipment (Elektro- und Elektronikgerätegesetz, ElektroG from 20 October 2015, BGBl. I p. 1739).

	CAUTION
	<p>Violation against existing law.</p> <ul style="list-style-type: none"> ⊘ Do NOT dispose of BINDER devices at public collecting points. ➤ Have the device disposed of professionally at a recycling company which is certified according to the German national law for electrical and electronic equipment (Elektro- und Elektronikgerätegesetz, ElektroG from 20 October 2015, BGBl. I p. 1739). <li style="padding-left: 20px;"><i>or</i> ➤ Instruct BINDER Service to dispose of the device. The general terms of payment and delivery of BINDER GmbH apply, which were valid at the time of purchasing the chamber.

Certified companies disassemble waste BINDER equipment in primary substances for recycling according to Directive 2012/19/EU. In order to eliminate any health hazards to the employees of the recycling companies, the devices must be free from toxic, infectious or radioactive substances.

	<p>Prior to handing the chamber over to a recycling company, it is the user's responsibility that it is free from toxic, infectious or radioactive substances.</p> <ul style="list-style-type: none"> • Prior to disposal, clean all introduced or residual toxic substances from the chamber. • Prior to disposal disinfect the chamber from all sources of infection. Be aware that sources of infection may also be located outside the inner chamber. • If you cannot safely remove all toxic substances and sources of infection from the chamber, dispose of it as special waste according to national law. • Fill out the contamination clearance certificate (chap. 10) and enclose it with the chamber.
---	--

 	WARNING
	<p>Contamination of the device with toxic, infectious or radioactive substances.</p> <p>Danger of intoxication.</p> <p>Danger of infection.</p> <ul style="list-style-type: none"> ⊘ NEVER take a chamber contaminated with toxic substances or sources of infection for recycling according to Directive 2012/19/EU. ➤ Prior to disposal, remove all toxic substances and sources of infection from the chamber. ➤ Dispose of a chamber from which all toxic substances or sources of infection cannot be safely removed as special waste according to national law.

8.4 Disposal of the chamber in the member states of the EU except for the Federal Republic of Germany

According to Annex I of Directive 2012/19/EU of the European Parliament and of the Council on waste electrical and electronic equipment (WEEE), BINDER devices are classified as "monitoring and control instruments" (category 9) only intended for professional use". They must not be disposed of at public collecting points.

The chambers bear the symbol for the marking of electrical and electronic equipment manufactured / placed on the market in the EU after 13 August 2005 and be disposed of in separate collection according to the Directive 2012/19/EU on waste electrical and electronic equipment (WEEE). WEEE marking: crossed-out wheeled bin with solid bar under.

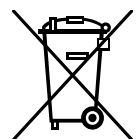



At the end of the device's service life, notify the distributor who sold you the device, who will take back and dispose of the chamber according to the Directive 2012/19/EU on waste electrical and electronic equipment (WEEE).



	CAUTION
	<p>Violation against existing law.</p> <ul style="list-style-type: none"> ⊘ Do NOT dispose of BINDER devices at public collecting points. ➤ Have the device disposed of professionally at a recycling company which is certified according to conversion of the Directive 2012/19/EU into national law. <i>or</i> ➤ Instruct the distributor who sold you the device to dispose of it. The agreements apply that were reached with the distributor when purchasing the chamber (e.g. his general terms of payment and delivery). ➤ If your distributor is not able to take back and dispose of the chamber, please contact BINDER service.

Certified companies disassemble waste BINDER equipment in primary substances for recycling according to Directive 2012/19/EU. In order to exclude any health hazard for the employees of the recycling companies, the devices must be free from toxic, infectious or radioactive substances.

	<p>Prior to handing the chamber over to a recycling company, it is the user's responsibility that it is free from toxic, infectious or radioactive substances.</p> <ul style="list-style-type: none"> • Prior to disposal, clean all introduced or residual toxic substances from the chamber. • Prior to disposal, disinfect the chamber from all sources of infection. Be aware that sources of infection may also be located outside the inner chamber. • If you cannot safely remove all sources of infection and toxic substances from the chamber, dispose of it as special waste according to national law. • Fill out the contamination clearance certificate (chap. 10) and enclose it with the chamber.
---	---

 	 WARNING
	<p>Contamination of the device with toxic, infectious or radioactive substances.</p> <p>Danger of intoxication.</p> <p>Danger of infection.</p> <ul style="list-style-type: none"> ⊘ NEVER take a chamber contaminated with toxic substances or sources of infection for recycling according to Directive 2012/19/EU. ➤ Prior to disposal, remove all toxic substances and sources of infection from the chamber. ➤ Dispose of a chamber from which all toxic substances or sources of infection cannot be safely removed as special waste according to national law.

8.5 Disposal of the chamber in non-member states of the EU

 	CAUTION
	<p>Alteration of the environment.</p> <ul style="list-style-type: none"> ➤ For final decommissioning and disposal of the oven, please contact BINDER Service. ➤ Follow the statutory regulations for appropriate, environmentally friendly disposal.

The main board of the oven includes a lithium cell. Please dispose of it according to national regulations.

9. Technical description

9.1 Factory calibration and adjustment

This chamber was calibrated and adjusted in the factory. Calibration and adjustment were performed using standardized test instructions, according to the QM DIN EN ISO 9001 system applied by BINDER (certified since December 1996 by TÜV CERT). All test equipment used is subject to the administration of measurement and test equipment that is also constituent part of the BINDER QM DIN EN ISO 9001 systems. They are controlled and calibrated to a DKD-Standard at regular intervals.

9.2 Definition of usable volume

The usable volume illustrated below is calculated as follows:

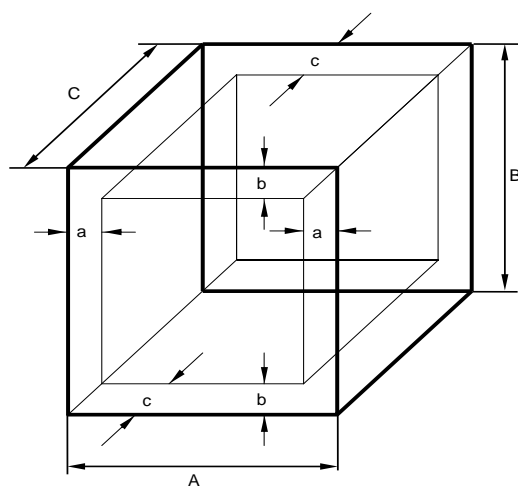

A, B, C = Internal dimensions (W, H, D)
a, b, c = Wall clearances

$$a = 0.1 \times A$$

$$b = 0.1 \times B$$

$$c = 0.1 \times C$$

$$V_{USE} = (A - 2a) \times (B - 2b) \times (C - 2c)$$

Figure 8: Determination of the useable volume

Technical data refers to the so defined usable volume.

	<p>Do NOT place samples outside this usable volume.</p> <p>Do NOT load this volume by more than half to enable sufficient airflow inside the chamber.</p> <p>Do NOT divide the usable volume into separate parts with large area samples.</p> <p>Do NOT place samples too close to each other in order to permit circulation between them and thus obtain a homogenous distribution of temperature.</p>
---	---

	<p>E 28: At working temperatures below approx. 70 °C / 158 °F and very low charge, temperature variations due to physical reasons can occur. In order to reduce them we recommend charging the oven with at least 20% of the usable volume.</p>
---	---

9.3 Over current protection

The chambers are protected by a miniature fuse against over current, accessible from the outside. The miniature fuse is located on the right side of the chamber below the strain relief of the power cord. The fuse holder is equipped with a fuse clip 5mm x 20 mm. A fuse may be replaced only with a substitute of the same ratings. Refer to the technical data of the respective device type.

9.4 B 28 technical data

Exterior dimensions			
Width, net	mm / inch	580 / 22.83	
Height, gross (incl. feet)	mm / inch	402 / 15.83	
Depth	mm / inch	425 / 16.73	
Depth, gross (incl. door handle)	mm / inch	510 / 20.08	
Wall clearance, rear (minimum)	mm / inch	100 / 3.94	
Wall clearance, side (minimum)	mm / inch	160 / 6.30	
Doors			
Number of doors		1	
Number of inner glass doors		1	
Interior dimensions			
Width	mm / inch	400 / 15.75	
Height	mm / inch	280 / 11.02	
Depth	mm / inch	250 / 9.84	
Interior volume	l / cu.ft.	28 / 0.99	
Racks			
Quantity of racks (regular)		2	
Quantity of racks (max.)		4	
Maximum load per rack	Kg / lbs	10 / 22	
Permitted total load	Kg / lbs	25 / 55	
Weight			
Weight (empty)	Kg / lbs	23 / 51	
Temperature data			
Temperature range, by 5 °C above ambient up to	°C	70 / 158	
Temperature fluctuation at 37 °C / 98.6 °F	± K	1	
Electrical data for B 28 230V type (model versions B028-230V, B028-230V-T)			
IP system of protection acc. to EN 60529	IP	20	
Nominal voltage (+/-10 %)	at 50 Hz power frequency	V	230
	at 60 Hz power frequency	V	230
Current type		1N~	
Nominal power	kW	0.25	
Power plug		Grounded plug	
Installation category acc. to IEC 61010-1		II	
Pollution degree acc. to IEC 61010-1		2	
Chamber fuse 5x20 mm / 250V / time-lag (T) / external	A	6,3	
Different electrical data for B 28 120V type constructed for the USA and Canada (model version B028-120V)			
Nominal voltage (+/-10 %) at 60 Hz power frequency	V	115	
Nominal power	kW	0.20	
Power plug	NEMA	5-15P	

All technical data is specified for unloaded chambers with standard equipment at an ambient temperature of +22 °C ± 3 °C / 71.6 °F ± 5.4 °F and a power supply voltage fluctuation of +/-10. Technical data is determined in accordance to BINDER Factory Standard Part 1:2015 following DIN 12880:2007.

All indications are average values, typical for chambers produced in series. We reserve the right to change technical specifications at any time.

9.5 E 28 technical data

Exterior dimensions			
Width, net		mm / inch	580 / 22.83
Height, gross (incl. feet)		mm / inch	402 / 15.83
Depth		mm / inch	425 / 16.73
Depth, gross (incl. door handle)		mm / inch	475 / 18.70
Wall clearance, rear (minimum)		mm / inch	100 / 3.94
Wall clearance, side (minimum)		mm / inch	160 / 6.30
Doors			
Number of doors			1
Interior dimensions			
Width		mm / inch	400 / 15.75
Height		mm / inch	280 / 11.02
Depth		mm / inch	250 / 9.84
Interior volume		l / cu.ft.	28 / 0.99
Racks			
Quantity of racks (regular)			2
Quantity of racks (max.)			4
Maximum load per rack		Kg / lbs	10 / 22
Permitted total load		Kg / lbs	25 / 55
Weight			
Weight (empty)		Kg / lbs	22 / 49
Temperature data			
Temperature range		°C	60 up to 230 140 up to 446
Temperature fluctuation	at 70 °C / 158 °F	± K	1.5
Temperature uniformity (variation)	at 70 °C / 158 °F	± K	3
Heating up time	to 70 °C / 158 °F	minutes	28
	to 150 °C / 302 °F	minutes	36
Recovery time after door was opened	at 70 °C / 158 °F	minutes	11
	at 150 °C / 302 °F	minutes	19
Air change (air flap open)	at 70 °C / 158 °F	x/h	30
Electrical data for E 28 230V type (model versions E028-230V, E028-230V-T)			
IP system of protection acc. to EN 60529		IP	20
Nominal voltage (+/-10 %)	at 50 Hz power frequency	V	230
	at 60 Hz power frequency	V	230
Current type			1N~
Nominal power		kW	0.80
Power plug			Grounded plug
Installation category acc. to IEC 61010-1			II
Pollution degree acc. to IEC 61010-1			2
Chamber fuse 5x20 mm / 250V / time-lag (T) / external		A	6.3
Different electrical data for E 28 120V type constructed for the USA and Canada (model version E028-120V)			
Nominal voltage (+/-10%) at 60 Hz power frequency		V	115
Power plug		NEMA	5-15P
Chamber fuse 5x20 mm / 250V / time-lag (T) / external		A	10

All technical data is specified for unloaded chambers with standard equipment at an ambient temperature of +22 °C +/- 3 °C / 71.6 °F +/- 5.4 °F and a power supply voltage fluctuation of +/-10. Technical data is determined in accordance to BINDER Factory Standard Part 1:2015 following DIN 12880:2007.

All indications are average values, typical for chambers produced in series. We reserve the right to change technical specifications at any time.



If the chamber is fully loaded, the specified heating up times may vary according to the load.

9.6 Equipment and Options (extract)



To operate the chamber, use only original BINDER accessories or accessories / components from third-party suppliers authorized by BINDER. The user is responsible for any risk arising from using unauthorized accessories.

	B 28	E 28
Standard equipment		
Hydraulic-mechanical thermostat	●	●
Analog thermometers	●	●
Timer 0-120 minutes	--	●
Inner glass door	●	--
Adjustable ventilation slide	●	●
Options / accessories		
Rack, chrome-plated	○	○
Perforated shelf, stainless steel	○	○
Temperature safety device class 1 acc. to DIN 12880:2007	○	○
Rubber pads for safe stacking (4 pieces)	○	○
Neutral cleaning agent (liquid concentrate)	○	○

Legend: ● Standard equipment ○ Optional -- Not available

9.7 Accessories and spare parts (extract)



BINDER GmbH is only responsible for the safety features of the chamber only, provided skilled electricians or qualified personnel authorized by BINDER perform all maintenance and repair, and if components relating to chamber safety are replaced in the event of failure with original spare parts. The user is responsible for any risks arising from using unauthorized accessories/components.

	B 28	E 28
Description	Art. no.	Art. no.
Rack, chrome-plated	6004-0001	6004-0001
Perforated shelf, stainless steel	6004-0028	6004-0028
Door gasket silicone	6005-0001	6005-0001
Rubber pads for safe stacking (4 pieces)	8012-0001	8012-0001
Temperature safety device class 3.1	5006-0006 (0 °C up to 100 °C)	5006-0001 (50 °C up to 300 °C)
Temperature safety device class 1 (option)	5006-0004 (105 °C, tolerance -9 °C)	5006-0002 (260 °C, tolerance -25 °C)
Miniature fuse 5x20 mm 250V 6,3 A time-lag (T) (model version 230V)	5006-0092	5006-0092
Miniature fuse 5x20 mm 250V 10 A time-lag (T) (model version 120V)	----	5006-0079
Thermometer	5016-0001 (10 °C up to 70 °C)	5016-0002 (0 °C up to 250 °C)
Radial switch 2-poles	5017-0002	--
Radial switch timer 0-120 minutes	--	5017-0014
Neutral cleaning agent, 1 kg	1002-0016	1002-0016

For information on components not listed here, please contact BINDER Service.

10. Certificates and declarations of conformity

10.1 EU Declaration of Conformity for B 28



Best conditions for your success



EU-Konformitätserklärung / EU Declaration of Conformity / Déclaration de conformité UE / Declaración de conformidad UE / Dichiarazione di conformità UE / Декларация соответствия EU

Hersteller / Manufacturer / Fabricant / Fabricante / Fabbicante / Производитель	BINDER GmbH
Anschrift / Address / Adresse / Dirección / Indirizzo / Адрес	Im Mittleren Ösch 5, 78532 Tuttlingen, Germany
Produkt / Product / Produit / Producto / Prodotto / Продукт	Inkubatoren mit mechanischer Regelung Incubators with mechanical adjustment Incubateurs à régulation mécanique Incubadoras con regulación mecánica Incubatori a controllo meccanico Инкубаторы с механической регулировкой
Typenbezeichnung / Type / Type / Tipo / Tipo / Тип	B 28

Das oben beschriebene Produkt ist konform mit folgenden EU-Richtlinien:
 The product described above is in conformity with the following EU Directives:
 Le produit décrit ci-dessus est conforme aux directives UE suivantes:
 El producto descrito arriba cumple con las siguientes directivas de la UE:
 Il prodotto sopra descritto è conforme alle seguenti direttive UE:
 Продукты, указанные выше, полностью соответствуют следующим EU руководствам:

- **2014/35/EU**
 Niederspannungsrichtlinie 2014/35/EU / Low voltage directive 2014/35/EU / Directive basse tension 2014/35/UE / Directiva sobre baja tensión 2014/35/UE / Direttiva Bassa tensione 2014/35/UE / Директива по низкому напряжению 2014/35/EU
- **2014/30/EU**
 EMV-Richtlinie 2014/30/EU / EMC Directive 2014/30/EU / Directive CEM 2014/30/UE / Directiva CEM 2014/30/UE / Direttiva EMC 2014/30/UE / Директива ЭМС 2014/30/EU
- **2011/65/EU**
 RoHS-Richtlinie 2011/65/EU / RoHS Directive 2011/65/EU / Directive RoHS 2011/65/UE / Directiva RoHS 2011/65/UE / Direttiva RoHS 2011/65/UE / Директива RoHS 2011/65/EU

Die oben beschriebenen Produkte tragen entsprechend die Kennzeichnung CE.
 The products described above, corresponding to this, bear the CE-mark.
 Les produits décrits ci-dessus, en correspondance, portent l'indication CE.
 Los productos descritos arriba, en conformidad, llevan la indicación CE.
 I prodotti sopra descritti, conformi a quanto sopra, portano il marchio CE.
 Данные продукты в соответствии с изложенным выше маркированы знаком CE.

1 / 2

BINDER GmbH Postfach 102 D-78502 Tuttlingen **Address:** BINDER GmbH Im Mittleren Ösch 5 78532 Tuttlingen Germany
Contact: Phone: +49 (0) 74 62 / 20 05 - 0 | Fax: +49 (0) 74 62 / 20 05 - 100 | info@binder-world.com | www.binder-world.com
Managing Director: Dipl.-Ing. Peter M. Binder | District court Stuttgart, HRB 727150 | Company head office: Tuttlingen Germany
Payment Details: Kreissparkasse Tuttlingen Account no.: 2266 | BAN: 643 500 70 | IBAN-Code: DE05643 500700 000002266 | SWIFT-Code: SOLA DE S1TUT
 \$-Account no. 2202 611 55 | IBAN-Code: DE7464350070 0220 261155 | SWIFT-Code: SOLA DE S1TUT
 Deutsche Bank Tuttlingen Account no.: 2 138 709 | BAN: 653 700 75 | IBAN-Code: DE56653 70075 0213870900 | SWIFT-Code: DEUT DE SS603
 Recycling of old equipment according to WEEE-Reg.-no. DE 37004983

Die oben beschriebenen Produkte sind konform mit folgenden harmonisierten Normen:
 The products described above are in conformity with the following harmonized standards:
 Les produits décrits ci-dessus sont conformes aux normes harmonisées suivantes:
 Los productos descritos arriba cumplen con las siguientes normas:
 I prodotti sopra descritti sono conformi alle seguenti normative armonizzate:
 Продукты, указанные выше, полностью соответствуют следующим стандартам:

Sicherheit / Safety / Sécurité / Seguridad / Sicurezza / Нормативы по безопасности
<ul style="list-style-type: none"> • EN 61010-1:2010 • EN 61010-2-010:2014
EMV / EMC / CEM / CEM / EMC / ЭМС
<ul style="list-style-type: none"> • EN 61326-1:2013
RoHS
<ul style="list-style-type: none"> • EN 50581:2012

78532 Tuttlingen, 03.07.2017
 BINDER GmbH



P. M. Binder
 Geschäftsführender Gesellschafter
 Managing Director
 Directeur général
 Director general
 Direttore Generale
 Генеральный Директор



J. Bollaender
 Leiter F & E
 Director R & D
 Chef de service R&D
 Responsable I & D
 Direttore R & D
 Глава департамента R&D

2 / 2

BINDER GmbH Postfach 102 D-78502 Tuttlingen **Address:** BINDER GmbH Im Mittleren Ösch 5 78532 Tuttlingen Germany
Contact: Phone: +49 (0) 74 62 / 20 05 - 0 | Fax: +49 (0) 74 62 / 20 05 - 100 | info@binder-world.com | www.binder-world.com
Managing Director: Dipl.-Ing. Peter M. Binder | District court Stuttgart, HRB 727150 | Company head office: Tuttlingen Germany
Payment Details: Kreissparkasse Tuttlingen Account no.: 2266 BAN: 643 500 70 | IBAN-Code: DE05643 500700 000002266 | SWIFT-Code: SOLA DE S1TUT
S-Account no. 2202 611 55 | IBAN-Code: DE7464350070 0220 261155 | SWIFT-Code: SOLA DE S1TUT
 Deutsche Bank Tuttlingen Account no.: 2 138 709 BAN: 653 700 75 | IBAN-Code: DE56653 70075 0213870900 | SWIFT-Code: DEUT DE SS603
 Recycling of old equipment according to WEEE-Reg.-no. DE 37004983

10.2 EU Declaration of Conformity for E 28



CE EU-Konformitätserklärung / EU Declaration of Conformity / Déclaration de conformité UE / Declaración de conformidad UE / Dichiarazione di conformità UE / Декларация соответствия EU

Hersteller / Manufacturer / Fabricant / Fabricante / Fabbricante / Производитель	BINDER GmbH
Anschrift / Address / Adresse / Dirección / Indirizzo / Адрес	Im Mittleren Ösch 5, 78532 Tuttlingen, Germany
Produkt / Product / Produit / Producto / Prodotto / Продукт	Trocken- und Wärmeschränke mit mechanischer Regelung Drying and heating ovens with mechanical adjustment Étuves de chauffage et de séchage à régulation mécanique Estufas de secado y calentamiento con regulación mecánica Stufe per essiccazione e riscaldamento a controllo meccanico Сушильные и сухожаровые шкафы с механической регулировкой
Typenbezeichnung / Type / Type / Tipo / Tipo / Тип	E 28

Das oben beschriebene Produkt ist konform mit folgenden EU-Richtlinien:

The product described above is in conformity with the following EU Directives:

Le produit décrit ci-dessus est conforme aux directives UE suivantes:

El producto descrito arriba cumple con las siguientes directivas de la UE:

Il prodotto sopra descritto è conforme alle seguenti direttive UE:

Продукты, указанные выше, полностью соответствуют следующим EU руководствам:

- 2014/35/EU**
 Niederspannungsrichtlinie 2014/35/EU / Low voltage directive 2014/35/EU / Directive basse tension 2014/35/UE / Directiva sobre baja tensión 2014/35/UE / Direttiva Bassa tensione 2014/35/UE / Директива по низкому напряжению 2014/35/EU
- 2014/30/EU**
 EMV-Richtlinie 2014/30/EU / EMC Directive 2014/30/EU / Directive CEM 2014/30/UE / Directiva CEM 2014/30/UE / Direttiva EMC 2014/30/UE / Директива ЭМС 2014/30/EU
- 2011/65/EU**
 RoHS-Richtlinie 2011/65/EU / RoHS Directive 2011/65/EU / Directive RoHS 2011/65/UE / Directiva RoHS 2011/65/UE / Direttiva RoHS 2011/65/UE / Директива RoHS 2011/65/EU

Die oben beschriebenen Produkte tragen entsprechend die Kennzeichnung CE.

The products described above, corresponding to this, bear the CE-mark.

Les produits décrits ci-dessus, en correspondance, portent l'indication CE.

Los productos descritos arriba, en conformidad, llevan la indicación CE.

I prodotti sopra descritti, conformi a quanto sopra, portano il marchio CE.

Данные продукты в соответствии с изложенным выше маркированы знаком CE.

1 / 2

BINDER GmbH Postfach 102 D-78502 Tuttlingen Address: BINDER GmbH Im Mittleren Ösch 5 78532 Tuttlingen Germany
 Contact: Phone: +49 (0) 74 62 / 20 05 - 0 | Fax: +49 (0) 74 62 / 20 05 - 100 | info@binder-world.com | www.binder-world.com
 Managing Director: Dipl.-Ing. Peter M. Binder | District court Stuttgart, HRB 727150 | Company head office: Tuttlingen Germany
 Payment Details: Kreissparkasse Tuttlingen Account no.: 2266 BAN: 643 500 70 | IBAN-Code: DE05643 500700 000002266 | SWIFT-Code: SOLA DE S1TUT
 \$-Account no. 2202 611 55 | IBAN-Code: DE7464350070 0220 261155 | SWIFT-Code: SOLA DE S1TUT
 Deutsche Bank Tuttlingen Account no.: 2 138 709 BAN: 653 700 75 | IBAN-Code: DE56653 70075 0213870900 | SWIFT-Code: DEUT DE SS603
 Recycling of old equipment according to WEEE-Reg.-no. DE 37004983

Die oben beschriebenen Produkte sind konform mit folgenden harmonisierten Normen:
 The products described above are in conformity with the following harmonized standards:
 Les produits décrits ci-dessus sont conformes aux normes harmonisées suivantes:
 Los productos descritos arriba cumplen con las siguientes normas:
 I prodotti sopra descritti sono conformi alle seguenti normative armonizzate:
 Продукты, указанные выше, полностью соответствуют следующим стандартам:

Sicherheit / Safety / Sécurité / Seguridad / Sicurezza / Нормативы по безопасности
<ul style="list-style-type: none"> • EN 61010-1:2010 • EN 61010-2-010:2014
EMV / EMC / CEM / CEM / EMC / ЭМС
<ul style="list-style-type: none"> • EN 61326-1:2013
RoHS
<ul style="list-style-type: none"> • EN 50581:2012

78532 Tuttlingen, 03.07.2017
 BINDER GmbH



P. M. Binder
 Geschäftsführender Gesellschafter
 Managing Director
 Directeur général
 Director general
 Direttore Generale
 Генеральный Директор



J. Bollaender
 Leiter F & E
 Director R & D
 Chef de service R&D
 Responsable I & D
 Direttore R & D
 Глава департамента R&D

2 / 2

BINDER GmbH Postfach 102 D-78502 Tuttlingen **Address:** BINDER GmbH Im Mittleren Ösch 5 78532 Tuttlingen Germany
Contact: Phone: +49 (0) 74 62 / 20 05 - 0 | Fax: +49 (0) 74 62 / 20 05 - 100 | info@binder-world.com | www.binder-world.com
Managing Director: Dipl.-Ing. Peter M. Binder | District court Stuttgart, HRB 727150 | Company head office: Tuttlingen Germany
Payment Details: Kreissparkasse Tuttlingen Account no.: 2266 BAN: 643 500 70 | IBAN-Code: DE05643 500700 000002266 | SWIFT-Code: SOLA DE S1TUT
 \$-Account no. 2202 611 55 | IBAN-Code: DE7464350070 0220 261155 | SWIFT-Code: SOLA DE S1TUT
 Deutsche Bank Tuttlingen Account no.: 2 138 709 BAN: 653 700 75 | IBAN-Code: DE56653 70075 0213870900 | SWIFT-Code: DEUT DE SS603
 Recycling of old equipment according to WEEE-Reg.-no. DE 37004983

11. Product registration

Online Product Registration

Register your BINDER now!

www.binder-world.com/register

The registration is free and takes just a few seconds

Advantages:

- ▶ Short response times if service is needed
- ▶ Fair prices when relocating or installing equipment
- ▶ Calibration as required at no charge in case of recalls
- ▶ Free information on news, product upgrades and accessories

Easy registered in 3 steps:



1. List serial number here:

-

2. Go online: www.binder-world.com/register

3. Register serial number

12. Contamination clearance certificate

12.1 For chambers located outside USA and Canada

Declaration regarding safety and health

Erklärung zur Sicherheit und gesundheitlichen Unbedenklichkeit

The German Ordinance on Hazardous Substances (GefStofV), and the regulations regarding safety at the workplace, require that this form be filled out for all products that are returned to us, so that the safety and the health of our employees can be guaranteed.

Die Sicherheit und Gesundheit unserer Mitarbeiter, die Gefahrstoffverordnung GefStofV und die Vorschriften zur Sicherheit am Arbeitsplatz machen es erforderlich, dass dieses Formblatt für alle Produkte, die an uns zurückgeschickt wird.

	<p>Note: A repair is not possible without a completely filled out form. Ohne Vorliegen des vollständig ausgefüllten Formblattes ist eine Reparatur nicht möglich.</p>
---	--

- A completely filled out form must be transmitted via Fax (+49 (0) 7462 2005 93555) or by letter in advance, so that this information is available before the equipment/component part arrives. A second copy of this form must accompany the equipment/component part. In addition, the carrier should be notified.

Eine vollständig ausgefüllte Kopie dieses Formblattes soll per Telefax (Nr. +49 (0) 7462 2005 93555) oder Brief vorab an uns gesandt werden, so dass die Information vorliegt, bevor das Gerät/Bauteil eintrifft. Eine weitere Kopie soll dem Gerät/Bauteil beigelegt sein. Ggf. ist auch die Spedition zu informieren.

- Incomplete information or non-conformity with this procedure will inevitably lead to substantial delays in processing. Please understand the reason for this measure, which lies outside our area of influence and will help us to speed up this procedure.

Unvollständige Angaben oder Nichteinhalten dieses Ablaufs führen zwangsläufig zu beträchtlichen Verzögerungen in der Abwicklung. Bitte haben Sie Verständnis für Maßnahmen, die außerhalb unserer Einflussmöglichkeiten liegen und helfen Sie mit, den Ablauf beschleunigen.

- **Please print and fill out this form completely.**

Bitte unbedingt vollständig ausfüllen!

1.	Unit/ component part / type: / Gerät / Bauteil / Typ:
2.	Serial No./ Serien-Nr.:
3.	Details about utilized substances / biological substances / Einzelheiten über die eingesetzten Substanzen/biologische Materialien:
3.1	Designations / Bezeichnungen:
a)	_____
b)	_____
c)	_____
3.2	Safety measures required for handling these substances / Vorsichtsmaßnahmen beim Umgang mit diesen Stoffen:
a)	_____
b)	_____
c)	_____

3.3 Measures to be taken in case of skin contact or release into the atmosphere / Maßnahmen bei Personenkontakt oder Freisetzung:
a) _____
b) _____
c) _____
d) _____
3.4 Other important information that must be taken into account / Weitere zu beachtende und wichtige Informationen:
a) _____
b) _____
c) _____
4. Declaration on the risk of these substances (please checkmark the applicable items) / Erklärung zur Gefährlichkeit der Stoffe (bitte Zutreffendes ankreuzen) :
<input type="checkbox"/> 4.1 For non toxic, non radioactive, biologically harmless materials / für nicht giftige, nicht radioaktive, biologisch ungefährliche Stoffe:
We hereby guarantee that the above-mentioned unit / component part... / Wir versichern, dass o.g. Gerät/Bauteil...
<input type="checkbox"/> Has not been exposed to or contains any toxic or otherwise hazardous substances / weder giftige noch sonstige gefährliche Stoffe enthält oder solche anhaften.
<input type="checkbox"/> That eventually generated reaction products are non-toxic and also do not represent a hazard / auch evtl. entstandene Reaktionsprodukte weder giftig sind noch sonst eine Gefährdung darstellen.
<input type="checkbox"/> Eventual residues of hazardous substances have been removed / evtl. Rückstände von Gefahrstoffen entfernt wurden.
<input type="checkbox"/> 4.2 For toxic, radioactive, biologically harmful or hazardous substances, or any other hazardous materials / für giftige, radioaktive, biologisch bedenkliche bzw. gefährliche Stoffe oder anderweitig gefährliche Stoffe.
We hereby guarantee that ... / Wir versichern, dass ...
<input type="checkbox"/> The hazardous substances, which have come into contact with the above-mentioned equipment/component part, have been completely listed under item 3.1 and that all information in this regard is complete / die gefährlichen Stoffe, die mit dem o.g. Gerät/Bauteil in Kontakt kamen, in 3.1 aufgelistet sind und alle Angaben vollständig sind.
<input type="checkbox"/> That the unit /component part has not been in contact with radioactivity / das Gerät/Bauteil nicht mit Radioaktivität in Berührung kam
5. Kind of transport / transporter / Transportweg/Spediteur:
Transport by (means and name of transport company, etc.) Versendung durch (Name Spediteur o.ä.)

Date of dispatch to BINDER GmbH / Tag der Absendung an BINDER GmbH:

We hereby declare that the following measures have been taken / Wir erklären, dass folgende Maßnahmen getroffen wurden:

- Hazardous substances were removed from the unit including component parts, so that no hazard exists for any person in the handling or repair of these items / das Gerät/Bauteil wurde von Gefahrstoffen befreit, so dass bei Handhabung/Reparaturen für die betreffenden Person keinerlei Gefährdung besteht
- The unit was securely packaged and properly identified / das Gerät wurde sicher verpackt und vollständig gekennzeichnet.
- Information about the hazardousness of the shipment (if required) has been provided to the transporter / der Spediteur wurde (falls vorgeschrieben) über die Gefährlichkeit der Sendung informiert.

We hereby commit ourselves and guarantee that we will indemnify BINDER GmbH for all damages that are a consequence of incomplete or incorrect information provided by us, and that we will exempt BINDER GmbH from eventual damage claims by third parties./ Wir versichern, dass wir gegenüber BINDER für jeden Schaden, der durch unvollständige und unrichtige Angaben entsteht, haften und BINDER gegen eventuell entstehende Schadenansprüche Dritter freistellen.

We are aware that, in accordance with Article 823 of the German Civil Code (BGB), we are directly liable with regard to third parties, in this instance especially the employees of BINDER GmbH, who have been entrusted with the handling / repair of the unit / component. / Es ist uns bekannt, dass wir gegenüber Dritten – hier insbesondere mit der Handhabung/Reparatur des Geräts/des Bauteils betraute Mitarbeiter der Firma BINDER - gemäß §823 BGB direkt haften

Name: _____

Position/Title: _____

Date / Datum: _____

Signature / Unterschrift: _____

Company stamp / Firmenstempel:



Equipment that is returned to the factory for repair must be accompanied by a completely filled out contamination clearance certificate. For service and maintenance on site, such a contamination clearance certificate must be submitted to the service technician before the start of any work. No repair or maintenance of the equipment is possible, without a properly filled out contamination clearance certificate.

12.2 For chambers in USA and Canada

Product Return Authorization Request

Please complete this form and the Customer Decontamination Declaration (next 2 pages) and attach the required pictures. E-mail to: IDL_SalesOrderProcessing_USA@binder-world.com

After we have received and reviewed the complete information we will decide on the issue of a RMA number. Please be aware that size specifications, voltage specifications as well as performance specifications are available on the internet at www.binder-world.us at any time.

Take notice of shipping laws and regulations.

	Please fill:	
Reason for return request	<input type="radio"/> Duplicate order	
	<input type="radio"/> Duplicate shipment	
	<input type="radio"/> Demo	<i>Page one completed by sales</i>
	<input type="radio"/> Power Plug / Voltage	115V / 230 V / 208 V / 240V
	<input type="radio"/> Size does not fit space	
	<input type="radio"/> Transport Damage	Shock watch tripped? (<i>pictures</i>)
	<input type="radio"/> Other (specify below)	

Is there a replacement PO?	<input type="radio"/> Yes <input type="radio"/> No	
<i>If yes -> PO #</i>		
<i>If yes -> Date PO placed</i>		
Purchase order number		
BINDER model number		
BINDER serial number		
Date unit was received		
Was the unit unboxed?	<input type="radio"/> Yes <input type="radio"/> No	
Was the unit plugged in?	<input type="radio"/> Yes <input type="radio"/> No	
Was the unit in operation?	<input type="radio"/> Yes <input type="radio"/> No	
<i>Pictures of unit attached?</i>	<input type="radio"/> Yes <input type="radio"/> No	Pictures have to be attached!
<i>Pictures of Packaging attached?</i>	<input type="radio"/> Yes <input type="radio"/> No	

	Customer Contact Information	Distributor Contact Information
Name		
Company		
Address		
Phone		
E-mail		

Customer (End User) Decontamination Declaration

Health and Hazard Safety declaration

To protect the health of our employees and the safety at the workplace, we require that this form is completed by the user for all products and parts that are returned to us. (Distributors or Service Organizations cannot sign this form)

	<p>NO RMA number will be issued without a completed form. Products or parts returned to our NY warehouse without a RMA number will be refused at the dock.</p>
---	--

A second copy of the completed form must be attached to the outside of the shipping box.

<p>1. Unit/ component part / type:</p>
<p>2. Serial No.</p>
<p>3. List any exposure to hazardous liquids, gasses or substances and radioactive material</p>
<p>3.1 List with MSDS sheets attached where available or needed (if there is not enough space available below, please attach a page):</p> <p>a) _____</p> <p>b) _____</p> <p>c) _____</p>
<p>3.2 Safety measures required for handling the list under 3.1</p> <p>a) _____</p> <p>b) _____</p> <p>c) _____</p>
<p>3.3 Measures to be taken in case of skin contact or release into the atmosphere:</p> <p>a) _____</p> <p>b) _____</p> <p>c) _____</p> <p>d) _____</p>
<p>3.4 Other important information that must be considered:</p> <p>a) _____</p> <p>b) _____</p> <p>c) _____</p>

4. Declaration of Decontamination

For toxic, radioactive, biologically and chemically harmful or hazardous substances, or any other hazardous materials.

We hereby guarantee that

- 4.1 Any hazardous substances, which have come into contact with the above-mentioned equipment / component part, have been completely listed under item 3.1 and that all information in this regard is complete.
- 4.2 That the unit /component part has not been in contact with radioactivity
- 4.3 Any Hazardous substances were removed from the unit / component part, so that no hazard exists for a persons in the shipping, handling or repair of these returned unit
- 4.4 The unit was securely packaged in the original undamaged packaging and properly identified on the outside of the packaging material with the unit designation, the RMA number and a copy of this declaration.
- 4.5 Shipping laws and regulations have not been violated.

I hereby commit and guarantee that we will indemnify BINDER Inc. for all damages that are a consequence of incomplete or incorrect information provided by us, and that we will indemnify and hold harmless BINDER Inc. from eventual damage claims by third parties.

Name: _____

Position: _____

Company: _____

Address: _____

Phone #: _____

Email: _____

Date: _____

Signature: _____



Equipment returned to the NY warehouse for repair must be accompanied by a completed customer decontamination declaration. For service and maintenance works on site, such a customer decontamination declaration must be submitted to the service technician before the start of work. No repair or maintenance of the equipment is possible without a completed form.