



BradyPrinter i3300

User Manual

Copyright and Trademarks

Disclaimer

This manual is proprietary to **Brady** Worldwide, Inc. (hereafter "**Brady**"), and may be revised from time to time without notice. **Brady** disclaims any understanding to provide you with such revisions, if any.

This manual is copyrighted with all rights reserved. No portion of this manual may be copied or reproduced by any means without the prior written consent of **Brady**.

While every precaution has been taken in the preparation of this document, **Brady** assumes no liability to any party for any loss or damage caused by errors or omissions or by statements resulting from negligence, accident, or any other cause. **Brady** further assumes no liability arising out of the application or use of any product or system described, herein; nor any liability for incidental or consequential damages arising from the use of this document. **Brady** disclaims all warranties of merchantability of fitness for a particular purpose.

Brady reserves the right to make changes without further notice to any product or system described herein to improve reliability, function, or design.

Trademarks

All brand or product names referenced in this manual are trademarks (™) or registered trademarks (®) of their respective companies or organizations.

© 2019 **Brady Corporation**. All Rights Reserved.

Brady Warranty

Our products are sold with the understanding that the buyer will test them in actual use and determine for him or herself their adaptability to his/her intended uses. Brady warrants to the buyer that its products are free from defects in material and workmanship, but limits its obligation under this warranty to replacement of the product shown to Brady's satisfaction to have been defective at the time Brady sold it. This warranty does not extend to any persons obtaining the product from the buyer.

THIS WARRANTY IS IN LIEU OF ANY OTHER WARRANTY, EXPRESS OR IMPLIED, INCLUDING, BUT NOT LIMITED TO, ANY IMPLIED WARRANTY OF MERCHANTABILITY OR FITNESS FOR A PARTICULAR PURPOSE, AND OF ANY OTHER OBLIGATIONS OR LIABILITY ON BRADY'S PART. UNDER NO CIRCUMSTANCES WILL BRADY BE LIABLE FOR ANY LOSS, DAMAGE, EXPENSE OR CONSEQUENTIAL DAMAGES OF ANY KIND ARISING IN CONNECTION WITH THE USE, OR INABILITY TO USE, BRADY'S PRODUCTS.

Safety and Environment

Please read and understand this manual before using the BradyPrinter i3300 for the first time. This manual describes all of the main functions of the printer.

Precautions

Before using the BradyPrinter i3300 printer, please note the following precautions:

- Read all instructions carefully before operating the printer and prior to performing any procedure.
- Do not place the unit on an unstable surface or stand.
- Do not place anything on top of the unit.
- Keep the top clear of obstructions.
- Always use the printer in a well ventilated area. Do not block the slots and opening on the unit, which are provided for ventilation.
- Only use the power source indicated on the rating label.
- Use only the power cord that comes with the unit.
- Do not place anything on the power cord.

Technical Support and Registration

Contact Information

For repair or technical assistance, locate your regional Brady Technical Support office by going to:

- **United States:** www.bradyid.com
- **Europe:** www.bradyeurope.com
- **Asia Pacific:** www.brady.co.uk/landing-pages/global-landing-page
- **Australia:** www.bradyid.com.au
- **Canada:** www.bradycanada.ca
- **Latin America:** www.bradylatinamerica.com

Registration Information

To register your printer, go to:

- www.bradycorp.com/register
- **Australia:** www.bradyid.com.au/register
- **China:** www.brady.com.cn/membercenter/register_product.aspx

Repair and Return

If for any reason you need to return the BradyPrinter i3300 printer for repair, please contact Brady Technical Support for repair and replacement information.

Document Conventions

When using this document, it is important that you understand the conventions used throughout the manual.

- All user actions are indicated by **Bold** text.
- References to menus, dialog boxes, button and screens are indicated by *Italics* text.

Contents

1 • Introduction

Features and Functions	1
Compatible Applications	2
System Specifications	2
Button Actions	2

2 • Setup

Unpacking and Setting up Printer	3
What's in the Box	3
Printer Components	4
Power	5
Setup	5
Power Save Mode	5
Put the Printer into Sleep Mode	6
Wake the Printer from Sleep Mode	6
Reboot the Printer	6
Install or Change Supplies	7
Ribbon	7
Install or Change Supplies	8
Recycling the Label and Ribbon Cartridges	10
Dismantling the Ribbon Cartridge	10
<i>Recycling Components</i>	11
Dismantling the Label Cartridge	12
<i>Recycling Components</i>	13
Connecting the Printer	14
Configuring the Printer for Network Communication	14
<i>Configuring an Ethernet Connection</i>	14
Wi-Fi	15
<i>Search to Connect</i>	15
<i>Manually Enter Settings</i>	15
Configuring Other Networks	16
Configuring a Direct USB Connection	16
Setting System Defaults	18

3 • Printing Labels

Navigation and Status	19
Material Details	19
Creating Labels	20
Print Adjustments	20
Print Energy	20
Horizontal Offset	21
Vertical Offset	21

Print Speed	21
Cutting Options	21
BPL Scripts	22
<i>Print Orientation</i>	22
<i>Mirror Print</i>	22
External Hardware	22
Printing Labels	23
Feeding and Cutting Label Stock	23
Printing Two-sided Sleeve Material	24
4 • Using System Tools	
Graphics & Fonts	25
Import	25
Delete	25
Installing Firmware Upgrades.....	26
5 • Maintenance	
Display System Information.....	27
Pre-maintenance Operations	27
Cleaning the Printer.....	29
Cleaning Residue from Printer	29
Cleaning the Display	29
Cleaning the Cutter Blade	30
Cleaning the Sensors	32
Cleaning the Cutter Blade Exit Area	33
Dust Cleaning	34
Cleaning the Print Head	34
Replacing the Supply Wiper	35
Clearing Jams	36
Printer Jam	36
Cutter Jam	36
6 • Troubleshooting	
A • Regulatory and Licensing	
End User License Agreement for Microsoft Windows CE©.....	40
Agency Compliance and Approvals.....	42
United States	42
<i>FCC Notice</i>	42
Canada	42
Mexico	42
Europe	43
<i>RoHS Directive 2011/65/EU, 2015/863/EU</i>	43
<i>Batteries Directive 2006/66/EC</i>	43
Turkey	43
China and Taiwan	43
Wireless Regulatory Information.....	44
United States	44

Canada	45
Mexico	45
European Union	45
Brazil	46
International	46

1 Introduction

Thank you for purchasing the BradyPrinter i3300, which you can use to create and print professional-looking industrial labels and signs. All you have to do is:

- Drop in a ribbon cartridge. You can choose from a wide range of single-color ribbons.
- Drop in a label cartridge. You can choose widths that range from 0.25 in. to 4 in. (6.4 mm to 101.6 mm), and come in many colors, styles, and materials.
- Send labels for printing from your labeling software.

Labels and ribbons from Brady Corporation are programmed with the ability to communicate with the printer and software. This allows you to gain the full benefit of the system.

Features and Functions

The following are just some of the features that make this system so easy to use and ready to meet your label-making requirements:

- Small, lightweight (approximately 11.5 lbs [5.2 kg]) unit, ready for your desktop.
- Color touch screen LCD display input.
- Single-color job printing at 300 DPI, up to 4 in. (101.6 mm) wide and up to 60 in. (1.5 m) long.
- Wide variety of ribbon colors.
- Easy loading label and ribbon supplies.
- Continuous and die-cut label supplies in a variety of high-performance materials.
- Transfer graphics from PC or USB flash drive. Supported graphic formats are Windows metafile (*.wmf), Bitmap (*.bmp), JPG file (*.jpg), Graphic Interchange Format (*.gif) and Portable Network Graphics (*.png).
- Print labels from PC.
- Automatic cutter.

BradyPrinter i3300 supports ZPL, jScript, DPL and BPL. For the list of supported commands, please visit www.BradyID.com/i3300.

Compatible Applications

The BradyPrinter i3300 is compatible with Brady® Workstation desktop software.

When used with Brady Workstation software, the printer will automatically recognize all enabled and compatible materials up to 4 in. (101.6 mm) wide. For operation of the printer with other software, refer to the documentation for your application.



Note: Only BradyPrinter i3300 supplies will work with this printer.

System Specifications

- **Weight:** 11.5 lbs (5.2 kg)
- **Dimensions (stored):** 9 in. x 12.0 in. x 9.5 in. (22.9 cm x 30.5 cm x 24.1 cm)
- **Operating Temperature:** 50 - 104°F (10-40°C)
- **Relative Humidity:** 10% to 80% RH non-condensing
- **Storage:** -4 to 122°F (-20 to 50°C) at 15% to 90% RH non-condensing
- **Voltage:** 100-240 VAC 50/60 Hz, 2A
- **Print Resolution:** 11.8 dot/mm, 300 dpi
- **Output label size:** 0.25 in. to 4 in. (6.4 mm to 101.6 mm)
- **Maximum label length (continuous):** 60 in. (1.5 m)

Button Actions

There are three physical buttons on the front of the printer. Their function is described below.

-  The power button turns the printer on/off and is also used for sleep mode (see [page 6](#)).
-  The feed button advances the label. See [page 23](#) for more information.
-  The cut button allows you to manually cut the label.

2 Setup

Unpacking and Setting up Printer

Carefully unpack and inspect the printer surfaces (interior and exterior) and the labeling system for possible damage during shipping.

Note: Be sure to remove any transportation protection from around the print head and inside the enclosure cover.

What's in the Box

- BradyPrinter i3300
- Documentation CD including: electronic Quick Start Guide, electronic User's Manual and web links
- Power Cord
- USB Type B Cable
- Printed "Quick Start Guide"
- Cleaning Kit

Note: Please keep the original packaging, including the box, in case the printer must be returned.



CAUTION! If shipping the printer, consult with your transportation carrier for state, federal, municipal, and international shipping regulations regarding the lithium ion battery contained in the printer.

Printer Components



Figure 2-1. Printer Components

- | | |
|--|--------------------|
| 1 Display (with touchscreen) | 2 Power Button |
| 3 Enclosure Cover | 4 Label Exit Chute |
| 5 Supply Wiper | 6 Supply Guides |
| 7 Label Supply Roll | 8 Cutter |
| 9 Ribbon Cartridge | 10 Print Head Door |
| 11 (a) USB Ports, (b) Ethernet Port,
(c) Power Cord Connector and
(d) Power Switch | |

Note: The printer is equipped with a universal power supply and can be operated with a voltage of 100 to 240 V~, 50- to 60 Hz. The printer senses the voltage type and automatically adjusts for the power source.

Power

Setup

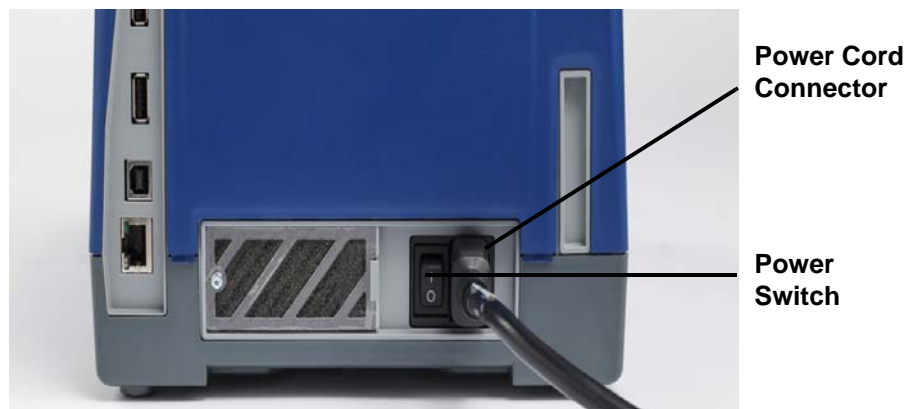

1. Plug the power cord into the printer at the location shown.
2. Plug the other end of the power cord into an AC power outlet.
3. Turn the power switch on. The printer turns on and displays the Home page. The size and color of the currently installed supplies and other status indicators are shown.

Note: If there is no ribbon or labels installed, the system defaults to black ribbon and 4 inch [101.6 mm] wide continuous white labels.



Power Save Mode

When the printer is plugged in, you can leave it in a state of readiness all the time so that software can find the printer. Or you can choose to conserve power so that the printer automatically turns off after a period of inactivity.

1. Make sure the printer is turned on.
2. Tap **Settings** .
3. Press **System Configuration > Power Save Mode**.
4. Choose **AC Power**.
5. Slide the time indicator dot left (decrease) or right (increase) for the amount of inactive time that can elapse before the printer automatically shuts down. Alternatively you can press the minus (-) button to decrease or the plus (+) button to increase the time.
6. Tap  to return to the home screen.

Put the Printer into Sleep Mode

When the system is asleep the display turns off and the system goes into a low power consumption state but does not require a cold start to turn back on. In this state, you can either touch the screen or press the power button to return the system to the same state it was in before going into lower power consumption mode. When the printer is in sleep mode the power button is lit green.

Note: To fully shut down the printer press and hold the power button for longer than two seconds.

1. With the printer on, press and hold  for approximately two seconds.
2. If there are unsaved changes in the currently active file, you will be prompted to save the current label file.

Wake the Printer from Sleep Mode

If you do not touch the screen or keypad for a defined period of time, the system turns off the display and goes into a low-power consumption mode. When in Sleep Mode, the power button is lit green. The current label and settings are retained.

1. Press  or touch the screen.
2. Continue with your label activities.

Reboot the Printer

Use this procedure to reboot the printer.

1. Press and hold  for at least 5 seconds. The system performs the initialization process and starts the printer.
2. When the *Home* page displays, you can continue with your label activities.

Install or Change Supplies

Brady and ribbon cartridges use a “smart cell” to define and track information. The system automatically recognizes the installed and ribbon.

Note: The printer can be either on or off when changing supplies.

Ribbon

1. To remove ribbon, open the enclosure cover.



2. Release the latch on the print head door [2] and swing open.
3. Release the ribbon cartridge latch [3] and lift the ribbon cartridge up and out.

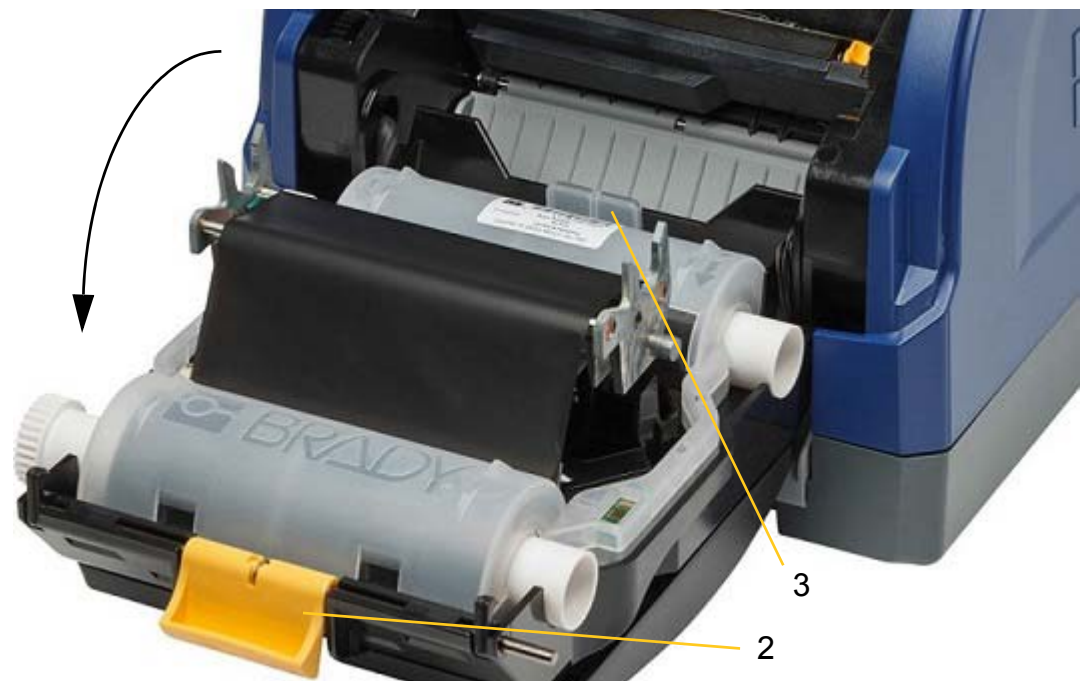

4. Place ribbon cartridge with ribbon over print head (product label toward machine), then snap into place.
5. Close and latch the print head door.
6. Close the enclosure cover.
7. If printer was asleep, press . The system detects the installed supplies, sets label and ribbon colors, indicates the label dimensions and the amount of remaining supplies.

Install or Change Supplies

1. Open the enclosure cover.



2. Release the latch on the print head door [2] and swing open.

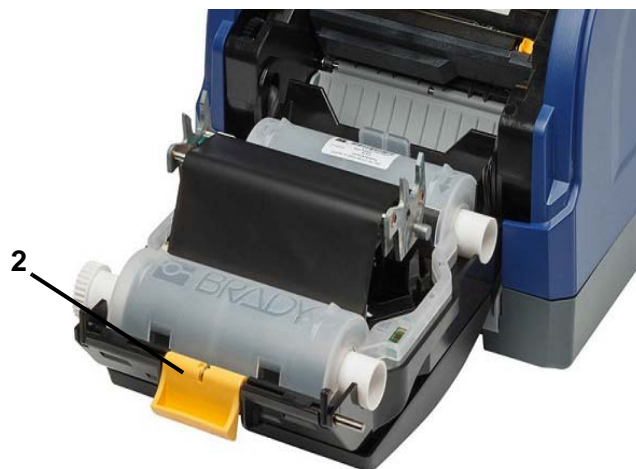

3. Swing yellow supply wiper [3] to the back, if engaged.

4. Slide yellow supply guides [4] to full-open.
5. Remove existing supply, if installed, by pulling label cartridge from printer.
6. Insert new cartridge until spindle ends rest in slots of holder [5].
7. Feed labels from top of roll until it sits just past the black rubber roller.
8. Close supply guides until they touch edge of supply liner with labels under the guides.
9. Move supply wiper into position so it rests on the label.

Note: Not all labels require the use of the supply wiper. Engage the wiper only if needed for the labels installed.

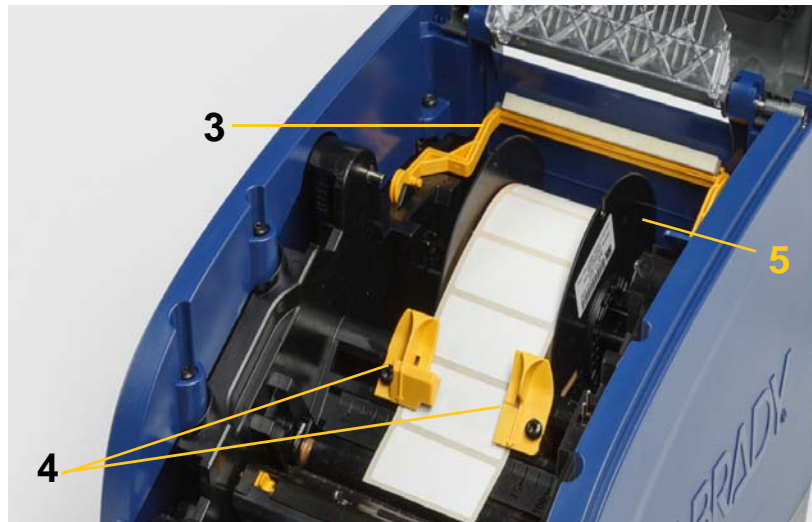

10. Close and latch print head door, then close enclosure cover.
11. If printer was asleep, press . The system detects the installed supplies, sets background and foreground colors, indicates the label dimensions and the amount of remaining supplies.

Recycling the Label and Ribbon Cartridges

Cartridges need to be recycled in accordance with local regulations. Before recycling, the used cartridges must be pulled apart to release the individual components which then must be recycled in the correct recycling bins.

Materials Required:

- 9/32- inch blade or 1/4-inch blade (ribbon) and 5/32- inch blade (label) flathead screwdrivers
- Safety Glasses
- Safety Gloves



CAUTION! Always wear Person Protective Equipment (PPE) when dismantling a cartridge.

Dismantling the Ribbon Cartridge

1. Using your thumbnail or the blade of the screwdriver, apply pressure to push the clear plastic locking tabs up until the cartridge unlocks.



Lock Tabs

2. Insert the blade of the screwdriver next to each tab along the seam of the two halves of the cartridge and gently pry apart the halves.
Repeat this process on both sides of the cartridge until all tabs are disconnected and the cartridge opens.
3. Slide the smart cell out of its location slot.
4. Unwind the ribbon from the spools and peel the ribbon end from the cardboard cores.
5. Remove the ribbon spools from the center of the cardboard core.



Recycling Components

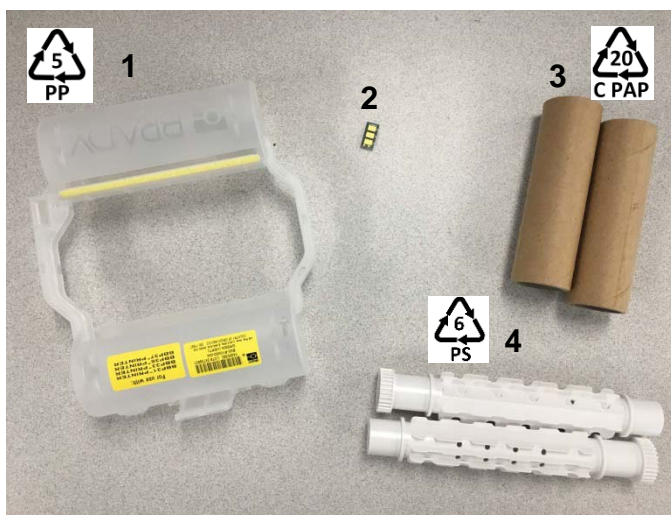

No.	Component	Material	Recycle Bin
1	Ribbon Cartridge (opaque)	PP	#5 PP
2	Smart Cell	Electronic	Electronic Waste
3	Cardboard Core	Cardboard	#20 C PAP
4	Ribbon Spools (white)	ABS	#6 PS

Dismantling the Label Cartridge

1. Using your thumbs, simultaneously apply pressure to the **release tabs** while pushing the center cylinder forward until the tabs release and unlock the center cylinder.
2. Pull the loose cylinder free from the label cartridge.
3. Using the screwdriver, place the blade in the gap next to the **smart cell holder** and pry the holder from the cylinder.
4. Remove the smart cell from the plastic holder.

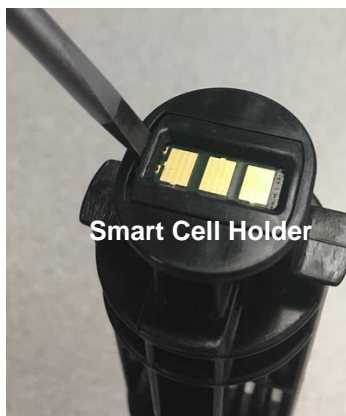

Smart Cell Holder

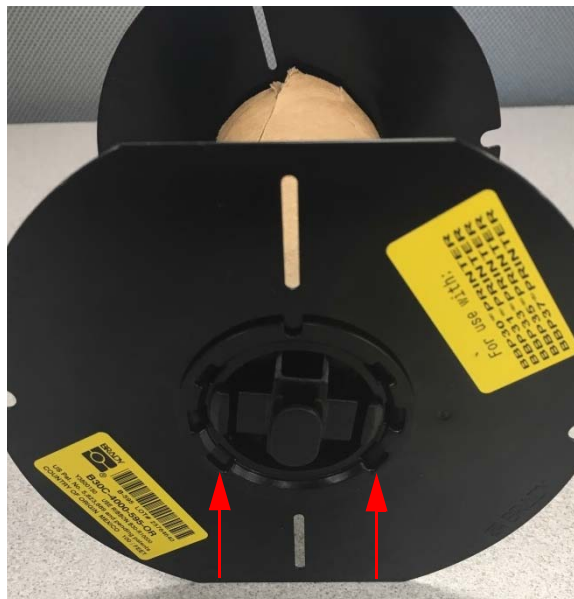

Release Tabs

5. Push the screwdriver blade between the flat cartridge guides and **locking end cap**. Twist the screwdriver and continue this process around the end cap until it comes off.
6. Repeat this process on the other side of the cartridge.
7. Remove the cardboard tube by pushing the center core out from the tube or by cutting the tube off of the core.



Locking End Cap

Recycling Components

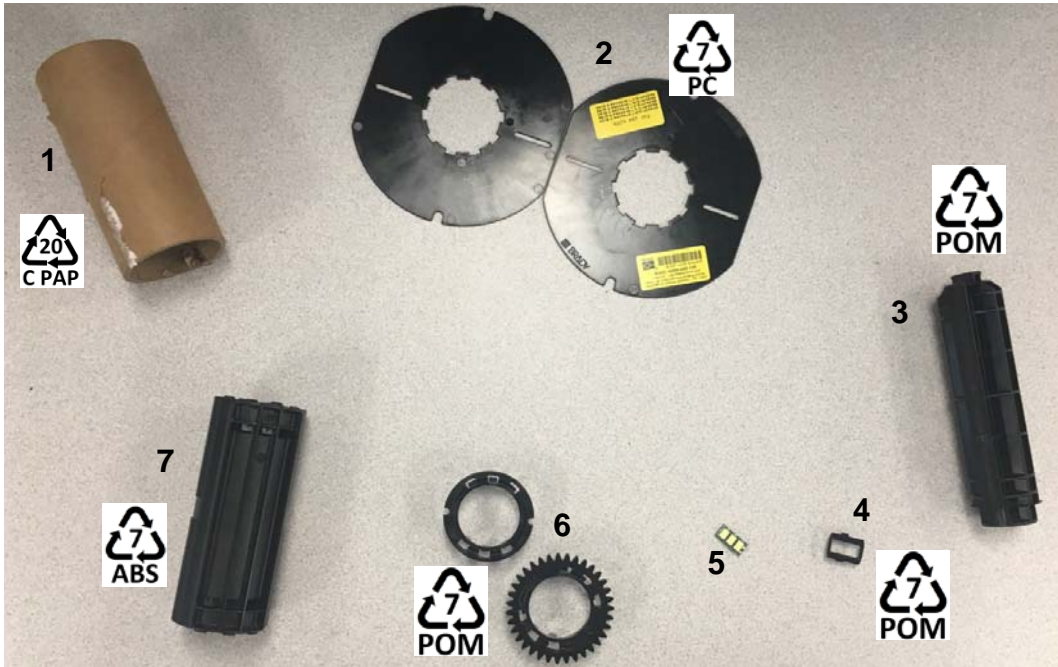

No.	Component	Material	Recycle Bin
1	Cardboard Tube	Cardboard	#20 C PAP
2	Cartridge Guides	PC	#7 PC
3	Center Cylinder	POM	#7 POM
4	Smart Cell Holder	POM	#7 POM
5	Smart Cell	Electronic	Electronic Waste
6	Locking End Caps	POM	#7 POM
7	Center Core	ABS	#7 ABS

Connecting the Printer

Connect to a computer in one or both of the following ways:

- On a network. This method allows multiple computers to send label files to the printer.
- Directly with a USB cable. See [Configuring a Direct USB Connection](#) on page 16.

Configuring the Printer for Network Communication

The printer has two network controllers - one for Ethernet (wired) and one for Wi-Fi. These two controllers act independently and can simultaneously receive data.

Note: Wi-Fi capability is not available on all printers or in all countries.

You can set up the printer for network communication using:

- An Ethernet connection. Use this option for a wired network.
- A Wi-Fi connection. See [Wi-Fi](#) on page 15.

Configuring an Ethernet Connection

1. On the *Home* screen tap **Settings**. 
2. On the *Settings* screen, select **Connection**.
3. Select **Advanced Network Settings** on the *Connection* screen.
4. Touch **Ethernet**.
5. Choose **IP Settings**.
6. For IP Settings, select either the DHCP or Static check box.
 - **DHCP:** DHCP addressing is dynamic and the system uses a DNS server to obtain the printer IP address for you.
 - **Static:** For static addressing, you must supply the printer's IP address.
7. If Static was selected, fill in the following fields:
 - **IP Address:** Enter the printer's IP address.
 - **Subnet Mask:** Enter a subnet mask if you are using one.
 - **Default Gateway:** Enter the IP address of the default gateway.
 - **DNS Server (Primary):** Enter the IP address of the primary DNS server.
 - **DNS Server (Secondary):** Enter the IP address of the secondary DNS server.

IMPORTANT! If no DNS server is being used, enter 0.0.0.0

8. Tap on the **back button** to get to the *Advanced Network Settings* screen in order for the fields entered to take effect.
9. If DHCP was selected, no additional fields need to be entered.

Wi-Fi

Connect to a Wi-Fi network either by searching for and selecting a network or by manually entering the network settings. Once connected, the printer can communicate with devices on that network. Devices can only communicate with the printer using either Brady Workstation software.

Search to Connect

To connect to a Wi-Fi wireless network:



1. Make sure the printer is turned on.
2. Tap **Settings**. 
3. On the *Settings* screen, select **Connection**.
4. Tap **Wi-Fi Network** to turn on Wi-Fi and choose a network from the list. If needed, the printer displays a keypad for entering the password.

If the network that you wish to connect to is not in the list, the network may be hidden. Use the steps in the following section to manually enter network settings.

Manually Enter Settings

Use this method for networks that are hidden.



To connect to a Wi-Fi wireless network:

1. Make sure the printer is turned on.
2. Tap **Settings**. 
3. On the *Settings* screen, select **Connection**.
4. Tap **Advanced Network Settings**.
5. Select **Wi-Fi** from the list.
6. Tap **IP Settings** and then tap one of the following.
 - **DHCP:** DHCP addressing is dynamic and the system uses a DNS server to obtain the printer IP address for you.
 - **Static:** Select static addressing to manually enter the printer's IP address.
7. Tap the back button to return to the *Network* screen. 
Get assistance from your network administrator for the remaining steps.
8. If you chose *DHCP*, configure the following settings.
 - a. Tap **DNS Server (Primary)** to display a keypad and then type the IP address of the DNS server. Tap  when finished.
 - b. Tap **DNS Server (Secondary)** and enter the IP address of the secondary DNS server.

9. If you chose *Static* in step 6, configure the following settings.
 - a. Tap **IP Address** to display a keypad and then type the IP address of the printer. Tap the enter button when finished.
 - b. Tap **Subnet Mask** and enter a subnet mask if you are using one.
 - c. Tap **Default Gateway** to enter the default gateway.
10. Tap  to return to the Home screen.

Configuring Other Networks

Configuration for personal or enterprise networks.

1. Touch the **Menu** button at the top of the *Home* screen.
2. Tap **Settings**. .
3. On the *Settings* screen, select **Connection**.
4. Tap **Wi-Fi Network** on the *Connection* screen.
 - If Wi-Fi is disabled, check the box next to Enabled and wait for the Network list to populate.
5. Scroll to the bottom of the list of available networks and select **Other**.
6. On the *Other Networks* screen, choose Personal or Enterprise network and fill in the necessary details.
7. Tap  when finished.

Configuring a Direct USB Connection

To communicate directly with a USB cable, you will need the USB device driver installed on your PC. Once connected, the computer should automatically detect and install the USB driver, if it is not already installed.

1. Attach the USB cable to the printer and computer.
2. Turn the printer on.

On the computer, “*Found New Hardware*” pops up in the lower right corner of the screen and the print driver wizard is launched.
3. In the wizard, click **Install the software automatically** (if it is not already selected).
4. Click **Next**.

The print driver installs. This takes a minute or two.
5. When complete, in the wizard, click **Finish**.

The BradyPrinter i3300 is now available to receive information from your computer labeling program. When printing from the computer, the printer must be attached to it via the USB cable. Be sure to select the BradyPrinter i3300 in the print dialog box of the labeling program.

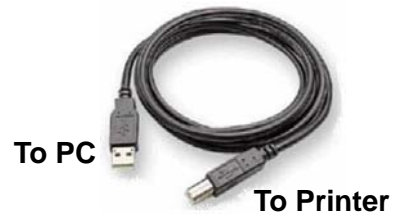

Setting System Defaults

Default values are common settings that are pre-assigned to make the system usable as soon as power is applied (for example, date and time are set to your local date and time). By changing the defaults, you can set the settings to your specific requirements.

Defaults set here will stay in effect even when power is removed from the printer and during upgrades.

To configure or change any of these settings:

1. Make sure the printer is turned on.
2. Tap **Settings** .
3. Select **System Configuration**.
4. Choose the setting to change.
 - **Language**
 - Select the desired language for messages displayed by the printer.
 - **Measurement Units**
 - Inches or Millimeters
 - **Date and Time**
 - **Power Save Mode** (see [page 5](#))

3 Printing Labels

Navigation and Status



Tap the home button at any time to return to the home screen.





While navigating the menus, tap the back button to go back to the previous page.



On the home screen, tap to scroll left or right.

The printer and material status icons in the status bar at the bottom of the home screen provide the following information.

Icon	Meaning
	The text above this icon indicates the label material installed in the printer.
	The printer cannot read the memory cell on the label roll. Labels may not be installed, may be installed incorrectly, or the memory cell may be corrupted.
 blinking	The printer is receiving data from the Brady Workstation software.

Material Details

To see detailed information about the installed supplies, click the label or ribbon part number in the status bar to open the *Material Details* screen.



Creating Labels

Create label files using Brady Workstation software. When you first create a label file, you specify the printer. This allows the software to provide features specific to your printer. Also, the software automatically detects the ribbon and labels installed in the printer.

For help using the software, refer to the documentation within the software.

Print Adjustments

As you print labels, keep the following in mind:

- The printer cuts between labels or at the end of the job, according to the selected cut settings.
- If there is no labels or ribbon installed, printing does not start and you will be prompted to install the supplies.
- If you open the print head door during the print operation, printing stops and a message displays prompting you to close the module. The print job is canceled. To print the labels, you must restart the print job.

These settings will be used on all print jobs. If you want to change them in a single job, be sure to reset to the default settings when you are done.

To set any of the following six settings, start by:

1. On the *Home* screen tap **Settings**. 
2. Select **Print Adjustments**.
3. Select the desired print adjustment.

Note: The Reset Default button sets the printer back to factory defaults.

Print Energy

Use the slider to adjust for darker or lighter printing. Print a label to test the setting.

The print energy setting defines how much heat is applied to the print head when printing a label. The darker the print energy, the more ink is transferred to the label. Optimal print energy settings are set automatically by the smart cell for the installed media and should only be changed if you are experiencing problems. For example, if printing is spotty you may want to increase the print energy to make sure more of the ribbon ink transfers to the label. However, if your ribbon is sticking or tearing during printing, the heat energy may be too high and should be reduced.



CAUTION! Constantly printing at high energy levels may cause printer jams or other printing errors and may reduce the overall life of your print head.

Note: The selected print energy setting will stay in effect for all subsequent print jobs with the currently installed media. When new media is installed, the print energy level is reset to the default setting. The print energy level is also reset by rebooting the system.

Horizontal Offset

Use the slider to the image (printed portion of the label) to the right or left. The number shown on the slider indicates how much the beginning print position will shift relative to the factory setting; it does *not* represent the distance from the left edge of the label.

Vertical Offset

Use the slider to shift print up or down on the labels. The number shown on the slider indicates how much the beginning print position will shift relative to the factory setting; it does *not* represent the distance from the top edge of the label.

Print Speed

Print speed lets you adjust the speed setting from 1 to 4 inches per second (ips). Optimal print speed settings are set automatically by the smart cell for the installed supply and should only be changed if you are experiencing problems. For example, you can change print speed if you want to print graphics or other densely populated labels more slowly to ensure complete coverage.

Use the slider to increase or decrease the speed.

Note: The selected print speed setting will stay in effect for all subsequent print jobs with the currently installed supply. When new supply is installed, the print speed is reset to the default setting. The print speed level is also reset by rebooting the system.

Cutting Options

Use this setting to set the cut location. Depending on the selected cut settings, the printer advances the label to tear/cut between labels, at the end of the job, or never. If no setting is used, the default will be the cut location set in Brady Workstation.

Note: The label size for die-cut labels is already set and cannot be adjusted.

BPL Scripts

Print Orientation

Use to rotate the starting position of label for BPL script jobs.

Sample Rotated

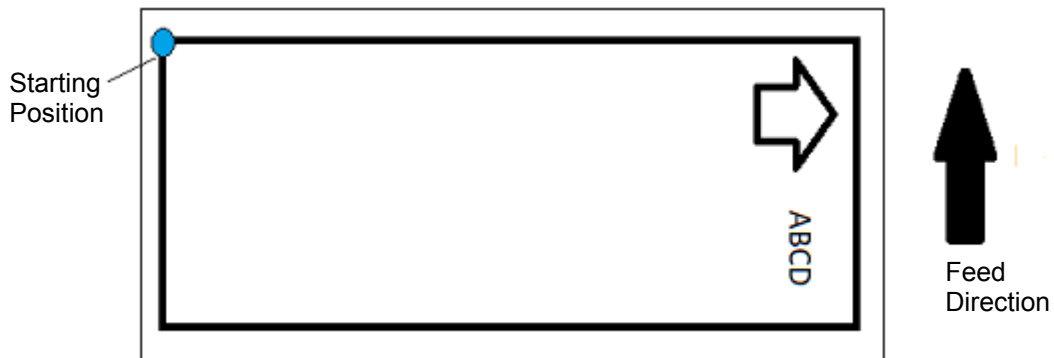

Sample Not Rotated

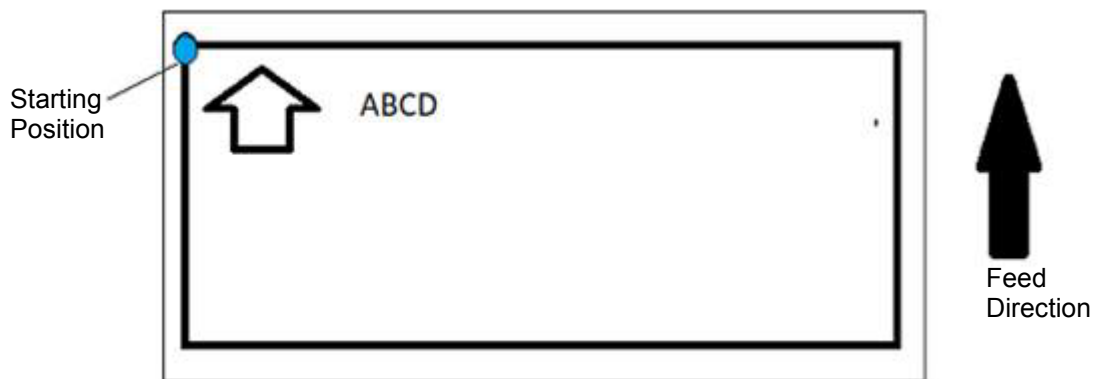

Mirror Print

Print labels suitable for reading in a mirror or through the back of the label.

External Hardware

To connect an external keyboard:

1. Plug the keyboard's USB cable into the USB port on the printer.
2. On the *Home* screen tap **Settings**. 
3. Select **External Hardware**.
4. Select **USB Keyboard** then choose the appropriate type of keyboard from the list.

Printing Labels

You must have labeling software installed on your computer to create, edit or print labels. Refer to your labeling software documentation for instructions about installing and using the software. See *“Compatible Applications” on page 2* for more details.

Feeding and Cutting Label Stock

If you install label supply that has a roughly cut front edge, it is best to feed and cut the label. Also, feed and cut if you have a partially printed job that you need to remove from within the printer.

To feed and/or cut label stock:

1. With the printer power on, press the **Feed** button repeatedly until the length of supply you want exits the printer.

Note: For die-cut labels, the supply advances to the cut position which is the next die-cut label. For continuous labels, the supply advances two inches each time you press the Feed button.

2. If desired, press **Cut** button. The printer will cut off the label.

Printing Two-sided Sleeve Material

When printing two-sided sleeve material, side one is loaded and printed directly from the roll. To print side two, the material is cut at the end of the job, then the printed strip of sleeves is loaded from the back of the printer for the second print pass.

A supply bridge holds the two-sided material above the tape roll. The two-sided material lays across the bridge to enter the tape entrance ramp. When done, the bridge is raised and snaps into the enclosure cover.

1. Print side one of the two-sided markers.
2. When the job is done, cut the printed markers.

Note: Use scissors or auto-cutter to cut the markers.

3. Open the enclosure cover and print head door.
4. Pull the leading edge of the supply backward out of the guides towards the roll, but do not remove the roll itself.

Note: The roll must remain in the supply slot or the printer will indicate a tape out condition.

5. Flip the supply bridge down so it lays over the roll.

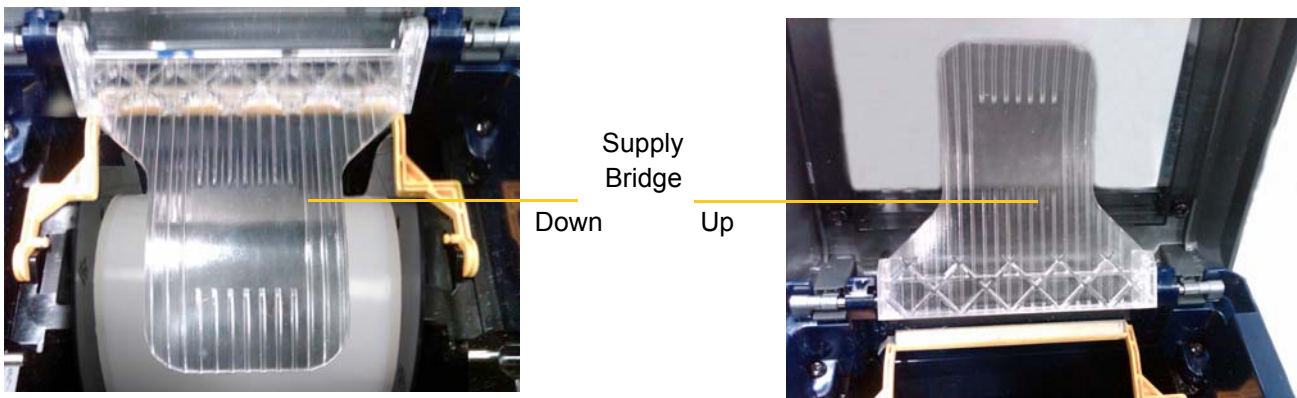

6. From the back of the printer, feed the leading edge of the PRINTED strip of sleeves through the slot between the enclosure cover and the printer body:
 - Note that the leading edge is the first sleeve in your print sequence.
 - Be sure the printed side is facing DOWN.
7. Lay the markers over the supply bridge and feed the markers to the top of the black roller approximately one quarter inch (6.35 mm) from the exit.
8. Close the print head door and the enclosure cover and print side two of the markers.
9. When the job is complete, open the enclosure cover and print head door.
10. Lift the supply bridge up and snap into place on the enclosure cover.
11. Close the enclosure cover.

4 Using System Tools

Graphics & Fonts

Import

To import graphics and fonts from a computer to the printer, first transfer the files to a USB flash drive. Then follow these steps:

1. Connect the USB flash drive to any available USB port on the printer.
2. On the *Home* screen, tap **Import Files**.
3. On the *Import Files from USB* screen, select **fonts** or **graphics**.
4. On the *Import Fonts/Graphics* screen, select the desired fonts/graphics to import to the printer

or use the Select All  button.

5. Press **Import** .
A progress bar will display while the import is taking place.

Note: If the system memory has run out of room an out of memory message will display.

Delete

To delete graphics and fonts imported to the printer, follow these steps:

1. On the *Home* screen select **File Manager**.
2. Choose Fonts or Graphics.
3. Select the check box next to specific fonts or graphics to delete or choose the Select All button at the bottom of the screen.

If you know the name of the font or graphic, press  to search for it.

4. Touch the desired option for sorting.
5. Review your selections and press the Delete  button.

Installing Firmware Upgrades

To upgrade firmware:



CAUTION! Do not interrupt printer power during an upgrade.

1. On a computer, go to www.bradyid.com.
2. Point to **Help** and then, under the *Downloads* heading, click **Firmware**.
3. Find the most recent BradyPrinter i3300 firmware upgrade in the list and click it. You can sort the list alphabetically to make it easier to find the printer model.
4. Click **Begin Download**.
5. Save the downloaded file to a USB flash drive.
6. Connect the USB flash drive to any available USB port on the printer. The printer recognizes the upgrade file and displays a message on the touch screen.
7. Follow the instructions on the touch screen. When the upgrade is complete, the printer restarts.

5 Maintenance

Display System Information

The *About* screen displays version numbers for various components of the system. Check the *Firmware driver* version when considering a firmware upgrade. Use the remaining information on the *About* screen if instructed by Brady Support.

To view system information:

1. From the home page, tap **Settings**. 
2. Tap **About**.

Pre-maintenance Operations

Before performing any maintenance procedure that involves opening the enclosure cover, you should remove the power and supplies from the printer.

1. Remove the power plug [1] from the printer.



2. Open the enclosure cover.



3. Release the latch on the print head door [2] and swing open.
4. Release the ribbon cartridge latch [3] and lift the ribbon cartridge up and out.

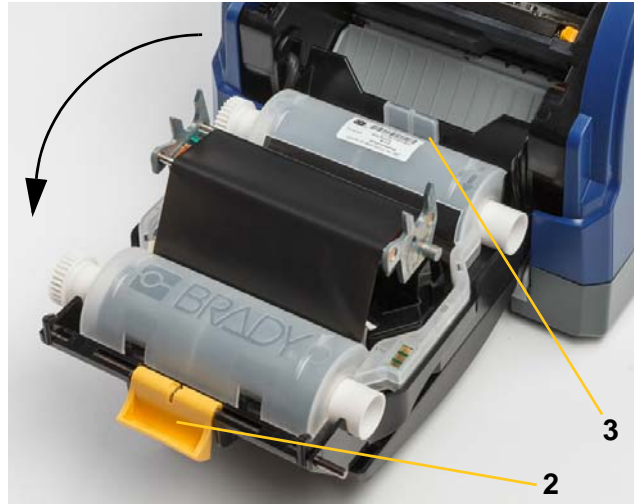

5. Move yellow supply wiper [4] to the back.
6. Move yellow supply guides [5] to full-open.
7. Remove cartridge from the slots of the holder [6].

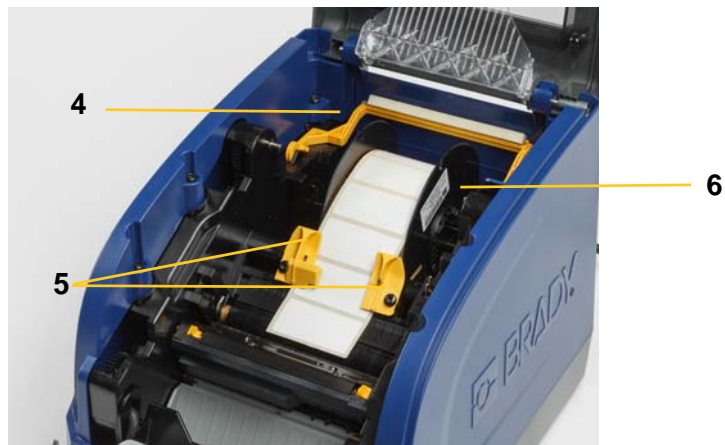

Cleaning the Printer

Cleaning Residue from Printer

Whenever performing any maintenance on the printer, you should also clean any residue caused by the labels.

Materials Required:

- Compressed Air Bottle, purchased locally (e.g., HOSA AIR-464 Gear Duster)
- Lint-free Cloth
- Isopropyl Alcohol
- Safety Glasses



CAUTION! Always wear safety glasses when using compressed air.

1. Remove power and supplies from the printer (see [Pre-maintenance Operations](#) on page 27).
2. With safety glasses on, spray compressed air on any parts of the printer that have built-up residue.

Note: If compressed air is not available, use a lint-free cloth lightly moistened with isopropyl alcohol and wipe off residue.

3. Replace the ribbon and labels.
4. Close all covers and plug in the power cord.

Cleaning the Display

Materials Required

- Lint-free Cloth, non-abrasive
- Isopropyl Alcohol
- or -
- Pre-moistened Cloth (appropriate for cleaning LCD displays)

Note: Normal cleaners with ammonia, soaps, or any acids can damage the screen. Use only a lint-free cloth dampened with isopropyl alcohol.

1. Lightly moisten a lint-free cloth with isopropyl alcohol, or use a pre-moistened cloth suitable for cleaning a PC screen.
2. Gently rub the damp cloth across the screen until all of the residue is removed.

Cleaning the Cutter Blade

Note: When cleaning the cutter, you should also clean the supply and cutter sensors.

Materials Required

- BradyPrinter i3300 Cleaning Kit (Cat # B31-CCT)
 - Isopropyl Alcohol
 - Cutter Cleaning Tool (included in cleaning kit)
1. Remove power and supplies from the printer (see [Pre-maintenance Operations](#) on page 27).
 2. Squeeze the two yellow cutter tabs [7] to release the cutter. The cutter mechanism and exit chute [8] will slide down behind the print head door.



3. Fill the plastic bottle from the cleaning kit with isopropyl alcohol.

4. Clean metal cutting blade [9]:

- a. If the cutting blade shows significant residue, use the cutter cleaning tool in the cleaning kit to gently scrape the residue off the cutting blade.
- b. Moisten one of the foam swabs from the cleaning kit with the alcohol. Do not allow the alcohol to drip from the swab.
- c. Clean cutting blade with moistened swab until all residue is removed.
- d. Clean beneath the edges of the blade housing with moistened swab. To avoid forcing residue deeper into the machine, use motions from the outer edge of the blade toward the center.
- e. Continue cleaning until no residue is visible and clean swabs do not become discolored.

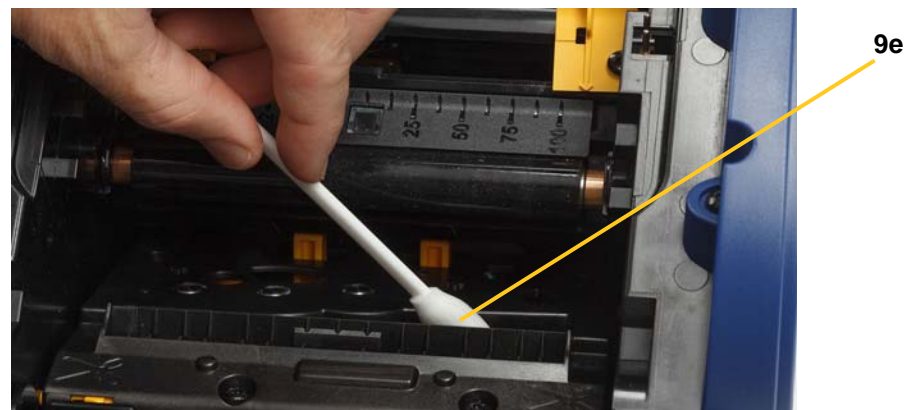

5. Close the cutting blade by pushing up on the exit chute until the cutter tabs snap into place.

Note: You may need to hold print head door up slightly to access the exit chute.

6. Replace the ribbon and label cartridges.
7. Close all covers and plug in the power cord.

Cleaning the Sensors

The supply and cutter sensors are located inside the printer and may be covered with dust that results from cutting the labels. One of the supply sensors is located under the yellow supply guide, as shown in the picture below. The cutter sensor is located above the cutting blade and is visible only when the cutter is released.

Materials Required

- BradyPrinter i3300 Cleaning Kit (Cat # B31-CCT)
 - Isopropyl Alcohol
1. Remove power and supplies from the printer (see [Pre-maintenance Operations](#) on page 27).
 2. Squeeze the two yellow cutter tabs to release the cutter; the cutter mechanism and exit chute will slide down exposing the cutter sensor.
 3. With a pre-moistened foam swab, gently wipe the surface of the cutter sensor [11] and the two supply sensors [10] at the locations shown:
 - a. Center die-cut sensor [10a]
 - b. Label out/die-cut sensor [10b]

Note: Sensor is located under the yellow supply guide

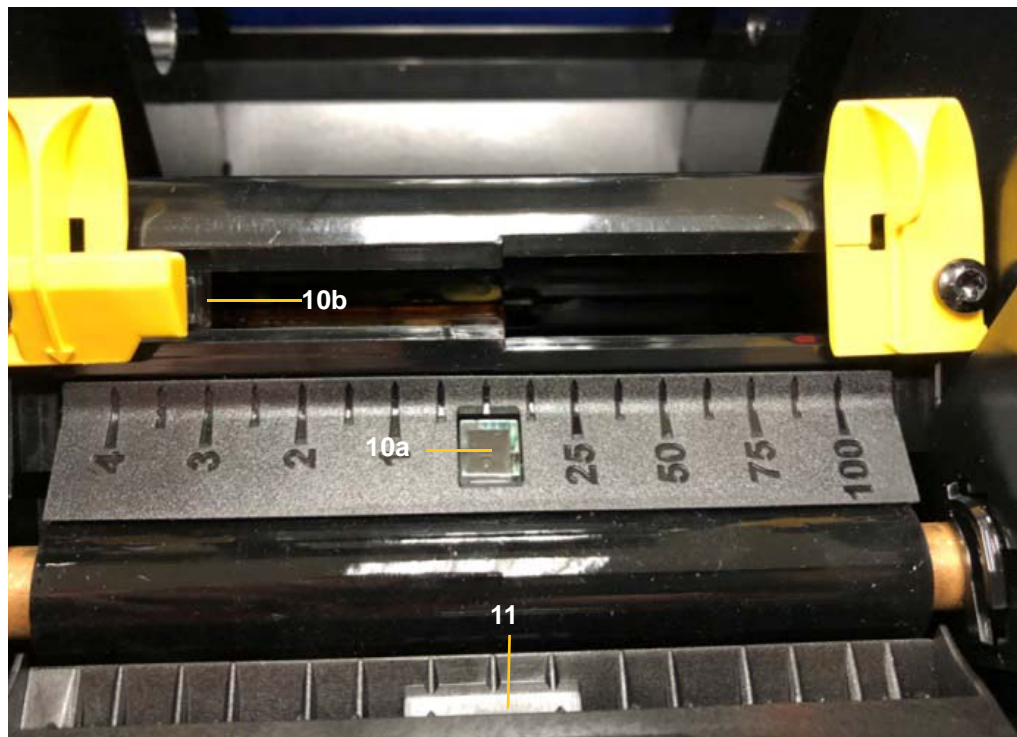

Cleaning the Cutter Blade Exit Area

This procedure cleans the cutter blade exit area and the exit chute.

Note: You should clean the exit area after cleaning the cutter blade and sensors. The cleaning swab may be damaged when cleaning the exit area.

Materials Required

- BradyPrinter i3300 Cleaning Kit (Cat # B31-CCT)
 - Isopropyl Alcohol
1. Remove power and supplies from the printer (see [Pre-maintenance Operations](#) on page 27).
 2. Close the print head door. It does not need to snap into place.
 3. Using swabs from the cleaning kit moistened with alcohol, clean the exit chute entrance [12] and exit chute ramp [13].

Note: To reach all areas of the exit chute, you can close the enclosure cover and tilt the printer up on its side.

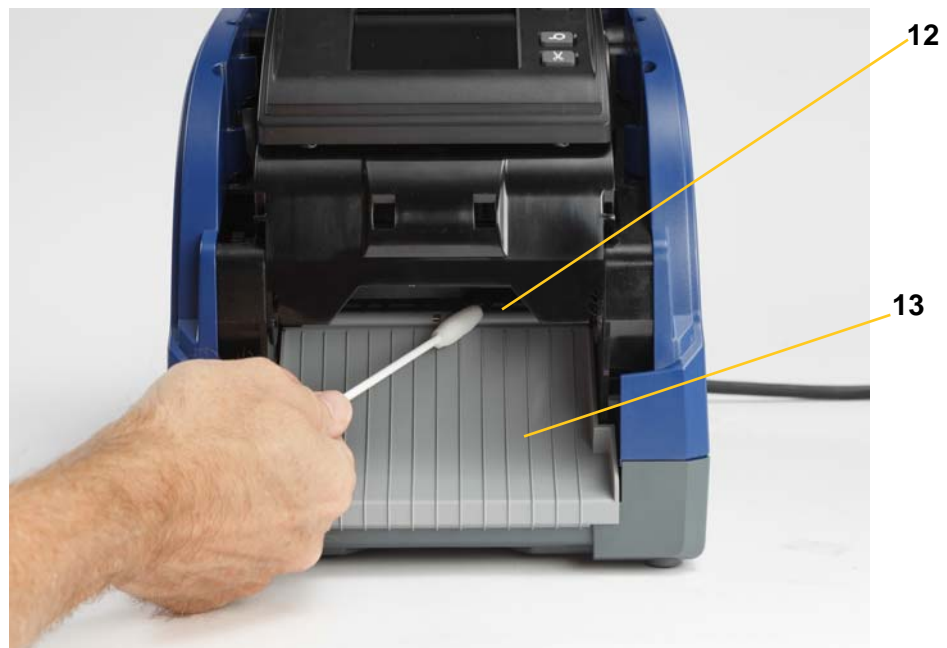

4. Replace the ribbon and label cartridges.
5. Close all covers, plug in the power cord, and turn on the power switch.

Dust Cleaning

Dust generated by supply cuts can accumulate in the unit. If a significant amount of dust is built up, clean the unit using this procedure.

Materials Required

- BradyPrinter i3300 Cleaning Kit (Cat # B31-CCT)
- Isopropyl Alcohol
- Compressed Air Bottle, purchased locally (e.g., HOSA AIR-464 Gear Duster)



CAUTION! Always wear safety glasses when using compressed air.

1. Remove power and supplies from the printer (see [Pre-maintenance Operations](#) on page 27).
2. Use compressed air to spray all visible areas inside the printer to remove accumulated dust.
3. Use a cloth moistened with isopropyl alcohol to wipe any remaining dust from inside the printer.
4. Wipe exterior cover and frame of printer for dirt and residue.

Cleaning the Print Head

Materials Required

- BradyPrinter i3300 Cleaning Kit (Cat # B31-CCT)
 - Isopropyl Alcohol
1. Remove power and supplies from the printer (see [Pre-maintenance Operations](#) on page 27).
 2. Fill the plastic bottle from the cleaning kit with isopropyl alcohol.

Note: Do not rub the swab over the bronze-colored area of the print head.

3. Moisten one of the foam swabs from the cleaning kit with the alcohol and gently rub across the green and black area of the print head [14].



CAUTION! Use only the materials supplied in the cleaning kit. Using other materials may permanently damage the print head.



4. Replace the ribbon and label cartridges.
5. Close all covers and plug in the power cord.

Replacing the Supply Wiper

Materials Required

- B31-WIPER
1. Remove power and supplies from the printer (see [Pre-maintenance Operations](#) on page 27).
 2. Lift and hold the wiper arm while grasping the tab of the wiper insert [15].
 3. Pull the tab slightly forward and then slide the wiper insert out of the wiper arm.
 4. To replace the wiper, insert the lip of the wiper insert into the slot [16] of the wiper arm and slide in until the tab snaps into place.

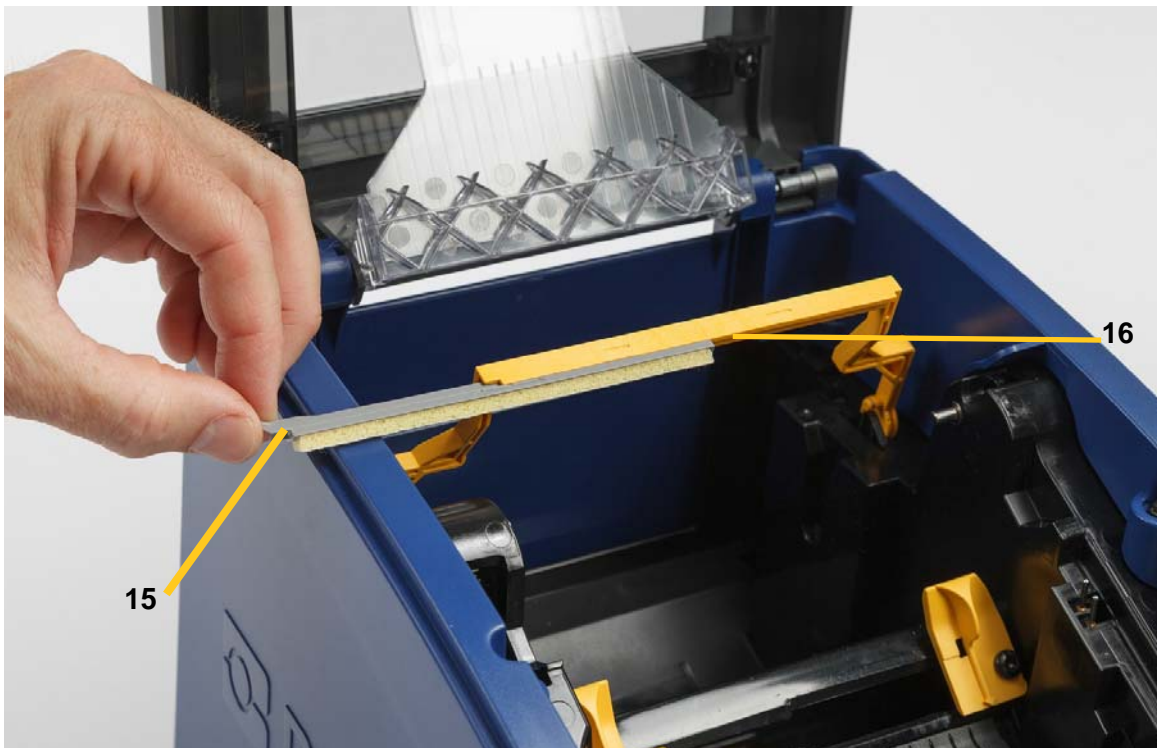

5. Replace the ribbon and label supply.
6. Close all covers and plug in the power cord.

Clearing Jams

Printer Jam

To clear jams from the printer:

1. Remove all damaged ribbon and/or labels from the printer.
2. Check that there is no damage to the print head, cutter blades, sensors, etc.
3. Check whether any cleaning is needed. If cleaning is required, see [Cleaning the Printer](#) on [page 29](#) for details.
4. Reload ribbon and labels and clear all error messages.

Cutter Jam

To clear a jam from the cutter:

1. Cut the supply as shown below.



2. Squeeze the tabs to release and tilt the cutter module.



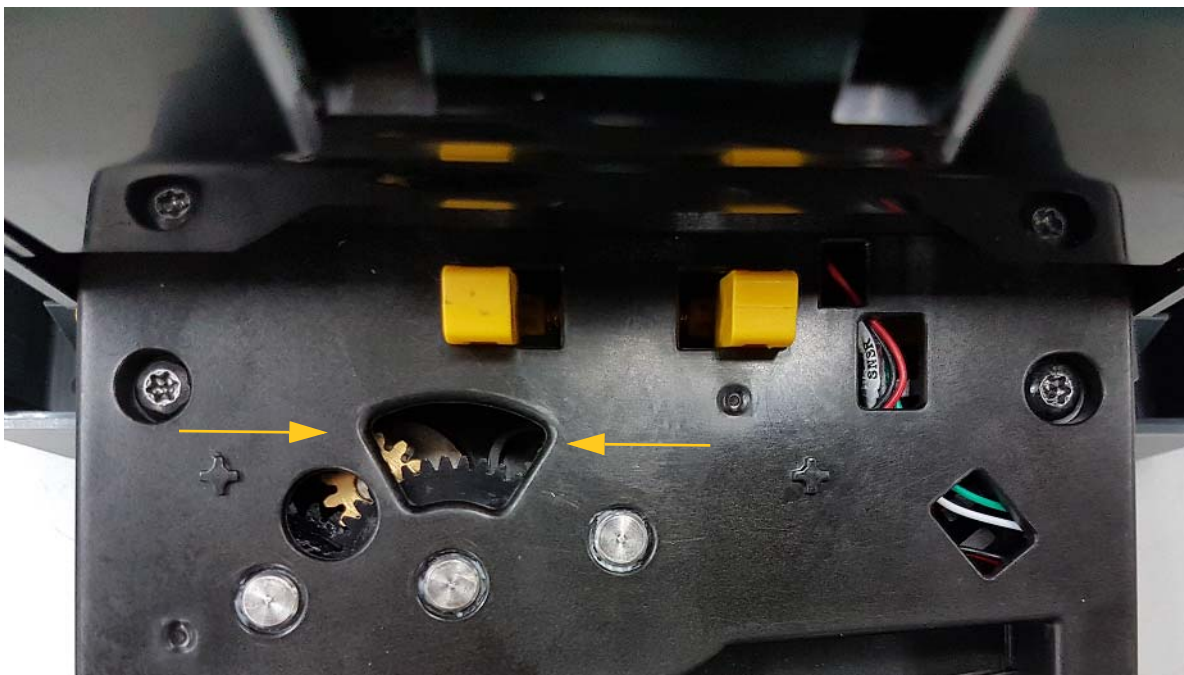

3. Rotate the cutter gear counter-clockwise to lower the blade.



4. Remove the supply.
5. Rotate the gear clock-wise to raise the blade.
6. Push the cutter mechanism back into place so that the pins snap into place.

6 Troubleshooting

Use the following table to troubleshoot problems. In situations where the printer displays an error message, follow the instructions on the touch screen.

Problem	Cause	Corrective Action
Printer does not power up when turned on.	Power cord has been pulled out of printer or wall socket.	Check power cord.
Screen freezes	User Interface error	<ol style="list-style-type: none"> 1. Press Power . 2. After printer goes to sleep, press Power  again. <p>If that doesn't work:</p> <ol style="list-style-type: none"> 1. Turn off the power switch on the side of the printer. 2. Wait five seconds and then turn the power switch on.
Printer will not feed labels.	<ul style="list-style-type: none"> • The leading edge of the label roll is not inserted correctly. • The leading edge of the label roll is uneven or torn (not a straight edge). 	<ul style="list-style-type: none"> • Install the labels correctly • Cut a straight leading edge on the label roll.
Faint print on labels.	Ribbon not advancing correctly.	<ul style="list-style-type: none"> • Tension the ribbon by rotating the rewind spool (top spool) in a downward direction until all slack is removed. • Try another ribbon cartridge.
	Print energy might be too low.	Adjust the print energy setting (see Print Energy on page 20).
No print on the label.	The label or ribbon is not loaded correctly or out of ribbon.	<ul style="list-style-type: none"> • Reinstall the ribbon cartridge. • Load a new ribbon.

Problem	Cause	Corrective Action
Poor print quality.	Ribbon and labels are incompatible, or using an incorrect label material and ribbon combination.	<ul style="list-style-type: none"> • Verify the correct ribbon for the label roll is loaded in the printer. • Change the ribbon or label combination.
	Dust or adhesives accumulated on the print head.	Clean the print head (see Cleaning the Print Head on page 34).
	Supply wiper dirty.	Replace supply wiper (see Replacing the Supply Wiper on page 35).
Void areas or lines appear on printed text.	Ribbon wrinkling.	<ul style="list-style-type: none"> • Tension the ribbon by rotating the rewind spool (top spool) in a downward direction until all slack is removed. • Try another ribbon cartridge.
Cut quality is poor.	Cutter needs cleaning.	Clean the cutter (see Cleaning the Cutter Blade on page 30).
Supply shifts when printing frames around label causing a slight misalignment of the frame.	Supply guides not adjusted correctly, producing slack that allows the labels to shift during printing.	Adjust supply guides so they are snug against the labels. To make fine adjustments to the frame, (see Print Energy on page 20.)

Regulatory and Licensing

End User License Agreement for Microsoft Windows CE®

You have acquired a device that includes software licensed by Brady Worldwide, Inc. from Microsoft Licensing or its affiliates (“MS”). Those installed software products of Microsoft origin, as well as associated media, printed materials, and “online” or electronic documentation (“SOFTWARE”) are protected by international intellectual property laws and treaties. The SOFTWARE is licensed, not sold. All rights reserved.

IF YOU DO NOT AGREE TO THIS END USER LICENSE AGREEMENT, DO NOT USE THE DEVICE OR COPY THE SOFTWARE. INSTEAD, PROMPTLY CONTACT BRADY WORLDWIDE, INC. FOR INSTRUCTIONS ON RETURN OF THE UNUSED DEVICE FOR A REFUND. **ANY USE OF THE SOFTWARE, INCLUDING BUT NOT LIMITED TO USE ON THE DEVICE, WILL CONSTITUTE YOUR AGREEMENT TO THIS END USER LICENSE AGREEMENT (OR RATIFICATION OF ANY PREVIOUS CONSENT).**

GRANT OF SOFTWARE LICENSE: This End User License Agreement grants you the following license:

You may use the SOFTWARE only on the DEVICE.

NOT FAULT TOLERANT. THE SOFTWARE IS NOT FAULT TOLERANT. BRADY WORLDWIDE, INC. HAS INDEPENDENTLY DETERMINED HOW TO USE THE SOFTWARE IN THE DEVICE, AND MS HAS RELIED UPON BRADY WORLDWIDE, INC. TO CONDUCT SUFFICIENT TESTING TO DETERMINE THAT THE SOFTWARE IS SUITABLE FOR SUCH USE.

NO WARRANTIES FOR THE SOFTWARE. **The SOFTWARE is provided “as is” and with all faults. THE ENTIRE RISK AS TO SATISFACTORY QUALITY, PERFORMANCE, ACCURACY, AND EFFORT (INCLUDING LACK OF NEGLIGENCE) IS WITH YOU. ALSO, THERE IS NO WARRANTY AGAINST INTERFERENCE WITH YOUR ENJOYMENT OF THE SOFTWARE OR AGAINST INFRINGEMENT.** IF YOU HAVE RECEIVED ANY WARRANTIES REGARDING THE DEVICE OR THE SOFTWARE, THOSE WARRANTIES DO NOT ORIGINATE FROM, AND ARE NOT BINDING ON, MS.

Note on Java support. The SOFTWARE may contain support for programs written in Java. Java technology is not fault tolerant and is not designed, manufactured, or intended for use or resale as online control equipment in hazardous environments requiring fail-safe performances, such as in the operation of nuclear facilities, aircraft navigation or communication systems, air traffic control, direct life support machines, or weapons systems, in which the failure of Java technology could lead directly to death, personal injury, or severe physical or environmental damage. Sun Microsystems, Inc. has contractually obligated MS to make this disclaimer.

No Liability for Certain Damages. EXCEPT AS PROHIBITED BY LAW, MS SHALL HAVE NO LIABILITY FOR ANY INDIRECT, SPECIAL, CONSEQUENTIAL OR INCIDENTAL DAMAGES ARISING FROM OR IN CONNECTION WITH THE USE OR PERFORMANCE OF THE SOFTWARE.

THIS LIMITATION SHALL APPLY EVEN IF ANY REMEDY FAILS OF ITS ESSENTIAL PURPOSE. IN NO EVENT SHALL MS BE LIABLE FOR ANY AMOUNT IN EXCESS OF U.S. TWO HUNDRED FIFTY DOLLARS (U.S.\$250.00).

Limitations on Reverse Engineering, Decompilation, and Disassembly. You may not reverse engineer, decompile, or disassemble the SOFTWARE, except and only to the extent that such activity is expressly permitted by applicable law notwithstanding this limitation.

SOFTWARE TRANSFER ALLOWED BUT WITH RESTRICTIONS. You may permanently transfer rights under this End User License Agreement only as part of a permanent sale or transfer of the Device, and only if the recipient agrees to this End User License Agreement. If the SOFTWARE is an upgrade, any transfer must also include all prior versions of the SOFTWARE.

EXPORT RESTRICTIONS. You acknowledge that SOFTWARE is of US-origin. You agree to comply with all applicable international and national laws that apply to the SOFTWARE, including the U.S. Export Administration Regulations, as well as end-user, end-use, and country destination restrictions issued by U.S. and other governments. For additional information on exporting the SOFTWARE, see <http://www.microsoft.com/exporting>.

Agency Compliance and Approvals

United States

FCC Notice

Note: This equipment has been tested and found to comply with the limits for a Class A digital device, pursuant to part 15 of the FCC Rules. These limits are designed to provide reasonable protection against harmful interference when the equipment is operated in a commercial environment. This equipment generates, uses, and can radiate radio frequency energy and, if not installed and used in accordance with the instruction manual, may cause harmful interference to radio communications.

Operation of this equipment in a residential area is likely to cause harmful interference in which case the user will be required to correct the interference at his own expense.

Changes or modifications not expressly approved by the party responsible for compliance could void the user's authority to operate the equipment.

This device complies with Part 15 of the FCC Rules. Operation is subject to the following two conditions: (1) This device may not cause harmful interference and, (2) this device must accept any interference received, including interference that may cause undesired operation.

Canada

Innovation, Science and Economic Development (ISED)

Canada ICES-003:

CAN ICES-3 (A)/NMB-3(A)

Mexico

IFETEL notice: La operación de este equipo está sujeta a las siguientes dos condiciones: (1) es posible que este equipo o dispositivo no cause interferencia perjudicial y (2) este equipo o dispositivo debe aceptar cualquier interferencia, incluyendo la que pueda causar su operación no deseada.

Europe



WARNING! This is a Class A product. In a domestic environment, this product may cause radio interference in which case the user may be required to take adequate measures.



Waste Electrical and Electronic Equipment Directive

In accordance with the European WEEE Directive, this device needs to be recycled in accordance with local regulations.

RoHS Directive 2011/65/EU, 2015/863/EU

This product is CE marked and complies with the European Union's Directive 2011/65/EU OF THE EUROPEAN PARLIAMENT AND OF THE COUNCIL of 8 June 2011 on the restriction of the use of certain hazardous substances in electrical and electronic equipment.

EU Directive 2015/863 of 31 March 2015 amends Annex II to Directive 2011/65/EU of the European Parliament and of the Council as regards the list of restricted substances.

Batteries Directive 2006/66/EC



This product contains a lithium coin cell battery. The crossed-out wheeled bin shown to the left is used to indicate 'separate collection' for all batteries and accumulators in accordance with European Directive 2006/66/EC. Users of batteries must not dispose of batteries as unsorted municipal waste. This Directive determines the framework for the return and recycling of used batteries and accumulators that are to be collected separately and recycled at end of life. Please dispose of the battery according to your local regulations.

Notice to Recyclers

To remove the lithium coin cell battery:

1. Disassemble printer and locate the lithium coin cell battery located on the main circuit board.
2. Using a small screwdriver, pry the battery from its holder and remove the battery from the board. Dispose of in accordance with local regulations.

Turkey

Turkish Ministry of Environment and Forestry

(Directive on the Restriction of the use of certain hazardous substances in electrical and electronic equipment).

Türkiye Cumhuriyeti: EEE Yönetmeliğine Uygundur

China and Taiwan

Find RoHS Declaration information for this product at www.BradyID.com/i3300compliance

Wireless Regulatory Information

Regulatory markings, subject to country certification, are applied to host printer signifying WiFi (radio) approvals have been obtained. These countries include; U.S., Canada, Mexico, European Union, Australia, New Zealand, South Africa, and South Korea.



WARNING! Operation of the device without regulatory approval is illegal.

WiFi radio module (permanently installed in printer having WiFi option)

Radio protocol	WLAN IEEE 802.11b/g/n
RF Operating Frequency	2.4 – 2.495 GHz
RF Output Power	< +20dBm EIRP (100mW)
Antenna Type \ Antenna Gain	PCB trace antenna \ -3.06 dBi
Environmental Operation	-40 to 85° C (-40° to 185° F) Note: Be mindful of Brady host printer user guide for maximum operating temperatures
Environmental Storage	-55 to 125° C (-67° to 257° F) Note: Be mindful of Brady host printer user guide for maximum storage temperatures

United States

Note: This equipment has been tested and found to comply with the limits for a Class A digital device, pursuant to part 15 of the FCC Rules. These limits are designed to provide reasonable protection against harmful interference when the equipment is operated in a commercial environment. This equipment generates, uses, and can radiate radio frequency energy and, if not installed and used in accordance with the instruction manual, may cause harmful interference to radio communications.

Operation of this equipment in a residential area is likely to cause harmful interference in which case the user will be required to correct the interference at own expense.

Changes or modifications not expressly approved by the party responsible for compliance could void the user's authority to operate the equipment.

This device complies with Part 15 of the FCC Rules. Operation is subject to the following two conditions: (1) This device may not cause harmful interference and, (2) this device must accept any interference received, including interference that may cause undesired operation.

Co-located statements: To comply with FCC RF exposure compliance requirement, the antenna used for this transmitter must not be co-located or operating in conjunction with any other transmitter/antenna except those already with radio module filing.

RF exposure guidelines: The radiated output power of this device is far below the radio frequency exposure limits. Nevertheless, to avoid the possibility of exceeding radio frequency exposure limits for an uncontrolled environment, a minimum 20cm distance should be maintained from WiFi radio module PCB antenna (internal) to the head, neck, or body during normal operation.

Canada

Innovation, Science and Economic Development (ISED)

CAN ICES-3 (A)/NMB-3(A)

This device complies with Industry Canada's license-exempt RSSs. Operation is subject to the following two conditions:

1. This device may not cause interference; and
2. This device must accept any interference, including interference that may cause undesired operation of the device.

Co-located statements: To comply with FCC RF exposure compliance requirement, the antenna used for this transmitter must not be co-located or operating in conjunction with any other transmitter/antenna except those already with radio module filing.

RF exposure guidelines / Important note: This equipment complies with IC radiation exposure limits set forth for an uncontrolled environment. This equipment should be installed and operated with minimum distance 20cm between the radiator and your body.

Note Importante: Déclaration d'exposition aux radiations: Cet équipement est conforme aux limites d'exposition aux rayonnements IC établies pour un environnement non contrôlé. Cet équipement doit être installé et utilisé avec un minimum de 20cm de distance entre la source de rayonnement et votre corps.

Mexico

IFETEL notice:

"La operación de este equipo está sujeta a las siguientes dos condiciones: (1) es posible que este equipo o dispositivo no cause interferencia perjudicial y (2) este equipo o dispositivo debe aceptar cualquier interferencia, incluyendo la que pueda causar su operación no deseada."

European Union

This is a Class A product. In a domestic environment, this product may cause radio interference in which case the user may be required to take adequate measures.

Radio Equipment Directive (RED) 2014/53/EC

- a. Frequency band(s) in which the radio equipment operates; 2.401GHz to 2.483GHz
- b. Maximum radio-frequency power transmitted in the frequency band(s) in which the radio equipment operate; < +20dBm EIRP (100mW)

Brazil



Este equipamento opera em caráter secundário, isto é, não tem direito a proteção contra interferência prejudicial, mesmo de estações do mesmo tipo, e não pode causar interferência a sistemas operando em caráter primário.

Este produto contém a placa model GS2011MIPS, código de homologação ANATEL 4208- 15-3693.

International

The WiFi radio module used in Brady host printers comply with internationally recognized standards covering human exposure to electromagnetic fields, i.e. EN 62311 "Assessment of electronic and electrical equipment related to human exposure restrictions for electromagnetic fields (0 Hz - 300 GHz)".

Locations

Brady Worldwide, Inc
6555 West Good Hope Road
P.O. Box 2131
Milwaukee, WI 53201-2131
www.bradycorp.com
Tel: 1-888-272-3946

Brady EMEA

Lindestraat 20
9240 Zele
Belgium
www.bradycorp.com/global
Tel: +32 (0) 52 45 78 11

Brady Corporation Asia

1 Kaki Bukit Crescent
Singapore 416236
www.bradycorp.com/global
Tel: 65-6477-7261

Brady Worldwide

Australia.....612-8717-6300
Brazil.....55-11-3686-4720
Canada..... 1-800-263-6179
China (Beijing)..... 86-10-6788-7799
China (Shanghai)..... 86-21-6886-3666
China (Wuxi)..... 86-510-528-2222
Hong Kong.....852-2359-3149
Japan..... 81-45-461-3600
Korea..... 82-31-451-6600
Latin America..... 1-414-540-5560
Malaysia..... 60-4-646-2700
Mexico.....525-399-6963
New Zealand..... 61-2-8717-2200
Philippines..... 63-2-658-2077
Singapore.....65-6477-7261
Taiwan..... 886-3-327-7788
Thailand..... 66-2-793-9200

i3300 User Manual (Printed-English):

Rev 28/2/2019

