



## Closed Cooling Water Circulator Neocool® Circulator

model **CF302L-A**

Instruction Manual

First Edition

- Thank you for choosing CF302L-A Neocool® Circulator from Yamato Scientific Co., Ltd.
- For proper equipment operation, please read and become thoroughly familiar with this instruction manual before use. Always keep equipment documentation safe and close at hand for convenient future reference.

 **Warning:** Read instruction manual warnings and cautions carefully and completely

**Yamato Scientific Co. Ltd.**

Printed on recycled paper



# TABLE OF CONTENTS

1. SAFETY PRECAUTIONS .....	1
Explanation of Symbols.....	1
Symbol Glossary .....	2
Warnings and Cautions .....	3
Residual Risk Map .....	6
List of Residual Risks.....	7
2. COMPONENT NAMES AND FUNCTIONS.....	10
External View .....	10
Circulation System .....	11
Control panel.....	12
Display Characters.....	12
3. PRE-OPERATION PROCEDURES .....	13
Installation Precautions .....	13
4. INSTALLATION PROCEDURES.....	16
Installation Procedure .....	16
5. OPERATION PROCEDURES.....	19
Operation procedure .....	19
User Setting .....	20
Calibration offset .....	21
Auto-resume function .....	22
Selection of circulation pump operation at temperature upper limit alert .....	23
LED brightness setting .....	24
6. HANDLING PRECAUTIONS .....	25
Warnings and Cautions .....	25
7. MAINTENANCE PROCEDURES .....	27
Inspection and Maintenance .....	28
8. EXTENDED STORAGE AND DISPOSAL.....	29
Extended Storage/Unit Disposal .....	29
Disposal Considerations .....	29
9. TROUBLESHOOTING .....	30
Error Codes.....	30
Troubleshooting Guide .....	31
10. SERVICE & REPAIR.....	32
Requests for Repair .....	32
11. SPECIFICATIONS.....	33
12. REFERENCE DATA.....	34
Cooling Capacity Curve .....	34
Cooling Curve .....	34
Pump Performance Curve.....	35

13. OPTIONAL ACCESSORIES .....	36
List of Options .....	36
14. WIRING DIAGRAM .....	39
CF302L-A.....	39
15. REPLACEMENT PARTS LIST .....	40
16. LIST OF HAZARDOUS SUBSTANCES .....	41
17. STANDARD INSTALLATION MANUAL .....	42

# 1. SAFETY PRECAUTIONS

## Explanation of Symbols

### A Word Regarding Symbols

Various symbols are provided throughout this text and on equipment to ensure safe operation. Failure to comprehend the operational hazards and risks associated with these symbols may lead to adverse results as explained below. Become thoroughly familiar with all symbols and their meanings by carefully reading the following text regarding symbols before proceeding

---

---

 **Warning** Signifies a situation which may result in serious injury or death (Note 1.)

 **Caution** Signifies a situation which may result in minor injury (Note 2) and/or property damage (Note 3.)

---

---

(Note 1) Serious injury is defined as bodily wounds, electrocution, bone breaks/fractures or poisoning, which may cause debilitation requiring extended hospitalization and/or outpatient treatment.

(Note 2) Minor injury is defined as bodily wounds or electrocution, which will not require extended hospitalization or outpatient treatment.

(Note 3) Property damage is defined as damage to facilities, equipment, buildings or other property.

### Symbol Meanings

 Signifies warning or caution.  
Specific explanation will follow symbol.

 Signifies restriction.  
Specific restrictions will follow symbol.

 Signifies an action or actions which operator must undertake.  
Specific instructions will follow symbol.

# 1. SAFETY PRECAUTIONS

## Symbol Glossary

### WARNING / CAUTION



General

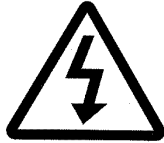

Danger!  
High Voltage



Danger!  
Extremely Hot



Danger!  
Moving Parts



Danger!  
Blast Hazard



Caution:  
Water Only



Caution:  
Shock Hazard!



Caution:  
Burn Hazard!



Caution:  
Do Not Heat  
Without Water!



Caution:  
May Leak Water!



Caution:  
Toxic Chemicals

### RESTRICTION



General  
Restriction



No Open Flame



Do Not  
Disassemble



Do Not Touch

### ACTION



General Action  
Required



Connect Ground  
Wire



Level Installation

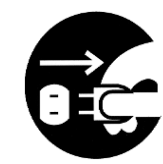

Disconnect Power



Inspect  
Regularly

# 1. SAFETY PRECAUTIONS

## Warnings and Cautions



### Install in a location free of flammables and explosives.

Never install or operate unit in a flammable or explosive gas atmosphere. Unit is NOT fire or blast resistant. Simply switching earth leakage breaker (ELCB) "ON" or "OFF" can produce a spark, which can then be relayed during operation, causing fire or explosion when near flammable or explosive fluids, chemicals or gases/fumes. See "16. LIST OF HAZARDOUS SUBSTANCES" (P.41) for information on flammable and explosive gases.



### Ground wire **MUST** be connected properly

- Connect power cable to a grounded outlet in order to avoid electric shock.
- Never connect ground wire to gas lines or water pipes. Fire, accident or equipment malfunction may result.
- Never connect ground wire to telephone grounding lines or to lightning conductor rods. Fire or electric shock may result.
- Never insert multiple plugs into a single outlet. Doing so may result in power cable overheating, fire or drop in voltage.

#### Connect to grounded outlet

Grounded outlet



Grounding prong

Grounded plug

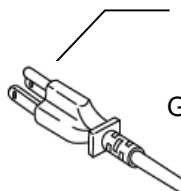

#### When no ground terminal is found

Contact original dealer of purchase for location-specific electrical requirements.



### Turn OFF (○) ELCB immediately when an abnormality occurs.

If unit begins emitting smoke or abnormal odors for reasons unknown, turn OFF (○) ELCB immediately, disconnect power cable from power supply, and contact original dealer of purchase for assistance. Continuing to operate without addressing abnormalities may cause fire or electric shock, resulting in serious injury or death. Never attempt to disassemble or repair unit. Repairs should be always be performed by a certified technician.

# 1. SAFETY PRECAUTIONS

## Warnings and Cautions



### Handle power cable with care.



- Do not operate unit with power cable bundled or tangled. Operating unit with the power cable bundled or otherwise tangled, may cause power cable to overheat and/or catch fire.
- Do not modify, bend, forcibly twist or pull on power cable. Fire or electric shock may result.
- Do not risk damage to power cable by positioning it under desks or chairs, or by allowing it to be pinched in between objects. Fire or electric shock may result.
- Do not place power cable near kerosene/electric heaters or other heat-generating devices. Doing so may cause power cable insulation to overheat, melt and/or catch fire, which may result in electric shock.
- Turn OFF(○) ELCB immediately and disconnect from facility terminal or outlet, if power cable becomes partially severed or damaged in any way. Contact original dealer of purchase for information about replacing power cable. Continuing to operate without addressing abnormalities may cause fire or electric shock, resulting in serious injury or death.
- Always connect power cable to appropriate facility outlet or terminal.
- Keep power cable connection clean. Buildup of dust on the connection may cause fire and/or electric shock.



### DO NOT disassemble or modify equipment

Never attempt to disassemble or modify unit. Doing so may cause malfunction, fire, electric shock, or personal injury. Note that any malfunction resulting from unauthorized modifications or customizations to unit will void the warranty.



### DO NOT touch hot/cold surfaces

Do not touch low and high temperature portions during or immediately following an operation. Severe burns or frostbite may result.



### DO NOT climb or place any objects on top of equipment.

Personal injury or equipment malfunction may result due to falling.  
Do not place any products other than those specified as options on top of unit.



### Keep upright.

Never tip or place unit on its side while moving or transporting. Damage to refrigeration system may result.  
If briefly tilting unit to one side or the other is unavoidable during transport, refrain from turning power on for at least 24 hours after positioning unit upright.



# 1. SAFETY PRECAUTIONS

## Warnings and Cautions



**CAUTION**



### **DO NOT operate equipment during thunderstorms**

In the event of a thunderstorm, turn OFF (○) ELCB and disconnect power cable immediately. A direct lightning strike may cause equipment damage, fire or electric shock, resulting in serious injury or death.



### **Turn OFF (○) ELCB in case of power failure.**

Operation stops when power failures occur. For added safety however, turn OFF (○) ELCB in the event of a power failure.

# 1. SAFETY PRECAUTIONS

## Residual Risk Map

These figures indicate positions of caution labels.

The numbers shown in the figure indicate the numbers listed in the "List of Residual Risks" in this manual.

For details of individual residual risks, see the List of Residual Risks.

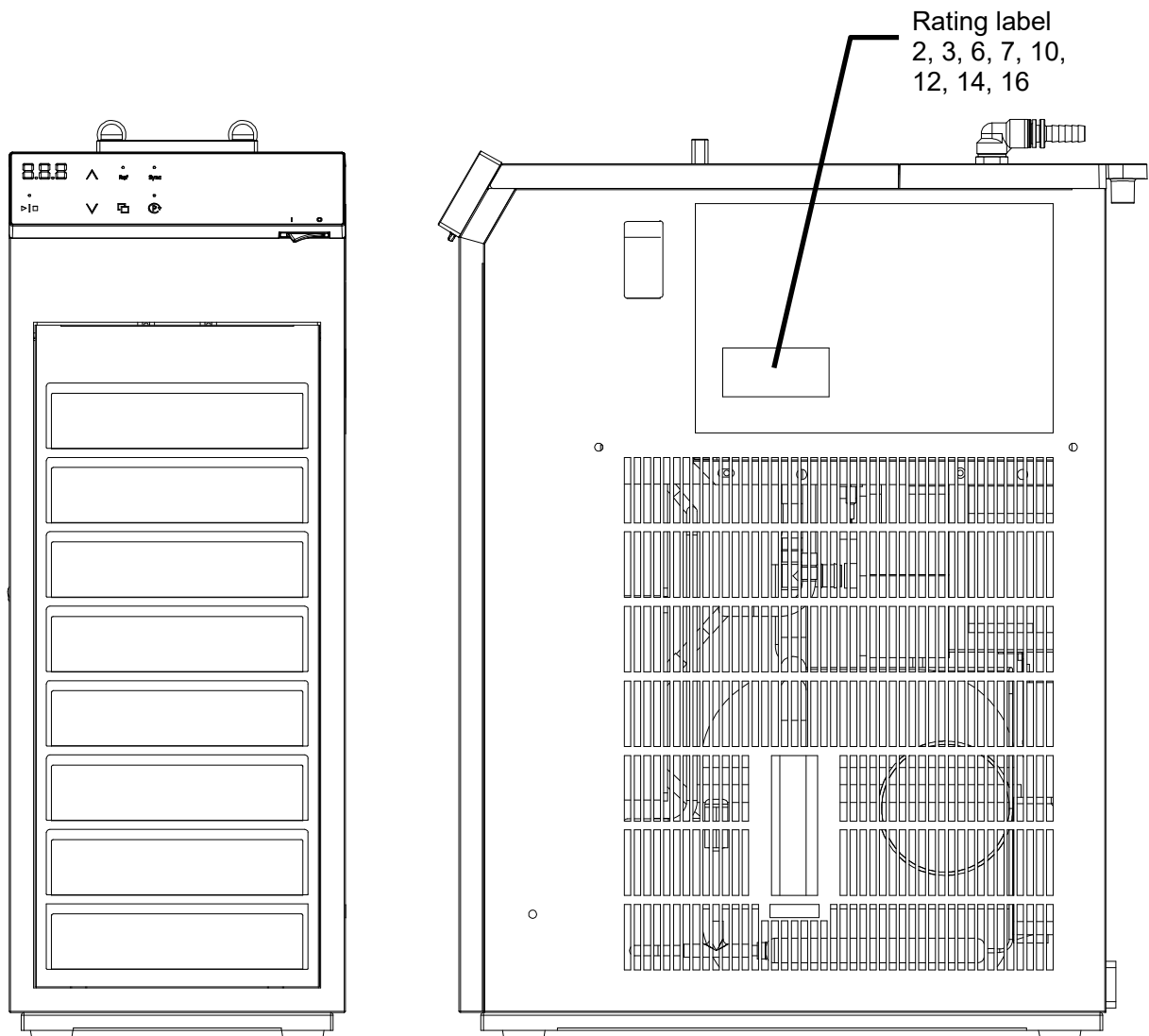

**\* Contact us if the caution signs are no more visible because nameplate is peeled off or texts are eliminated. We will send you a new nameplate. (for charge)**

# 1. SAFETY PRECAUTIONS

## List of Residual Risks

### List of residual risks (instructions for risk avoidance)

This list summarizes residual risks to avoid personal injuries or damages to properties during or related to the use of equipment.

**Be sure to fully understand or receive instructions on how to use, maintain and inspect equipment before starting operation.**

Loading/Installation				
No.	Degree of risks	Risk description	Protective measures taken by the user	Relevant page(s)
1	CAUTION	Injury	Always use cargo-handling equipment to move or install unit. Transport unit with sufficient number of people and an appropriate work method when carrying out manually.	13
2	WARNING	Fire/ Electric shock	Choose an appropriate installation site.	13
3	CAUTION	Injury	Install unit on a level surface.	13
4	CAUTION	Injury	Take appropriate safety measures when installing.	13
5	WARNING	Fire	Install equipment in a well-ventilated place	14
6	WARNING	Fire/ Electric shock	Install in a dry location.	14
7	WARNING	Explosion/Fire	Install in a location free of flammables and explosives.	3
8	WARNING	Fire/ Electric shock	Always connect power cable to appropriate facility outlet or terminal.	14
9	WARNING	Fire/ Electric shock	Handle power cable with care.	4
10	WARNING	Fire/ Electric shock	Ground wire MUST be connected properly	3
11	WARNING	Fire/ Electric shock	Never attempt to disassemble or modify unit.	4

# 1. SAFETY PRECAUTIONS

## List of Residual Risks

Use				
No.	Degree of risks	Risk description	Protective measures taken by the user	Relevant page(s)
12	WARNING	Explosion/Fire	DO NOT process explosive or flammable substances	25
13	WARNING	Fire/ Electric shock	Turn OFF (○) ELCB immediately when an abnormality occurs.	3
14	WARNING	Burn	DO NOT touch hot/cold surfaces	4
15	CAUTION	Fire	When unit stops operation due to power failure etc., be sure to confirm the state of unit at the time of power recovery.	25
16	WARNING	Injury	DO NOT climb or place any objects on top of equipment.	4
17	WARNING	Fire	DO NOT operate equipment during thunderstorms	5
18	CAUTION	Burn/ Injury	ALWAYS run equipment within specified temperature range.	25

# 1. SAFETY PRECAUTIONS

## List of Residual Risks

Daily inspection/maintenance				
No.	Degree of risks	Risk description	Protective measures taken by the user	Relevant page(s)
19	WARNING	Fire/ Electric shock	Be sure to disconnect power cable before daily inspection and maintenance.	27
20	WARNING	Burn/ Injury	Perform inspections and maintenance when unit and circulating water is at room temperature.	27
21	WARNING	Fire/ Electric shock	NEVER disassemble or modify unit	27

Extended storage/disposal				
No.	Degree of risks	Risk description	Protective measures taken by the user	Relevant page(s)
22	WARNING	Fire/ Electric shock	Turn OFF (○) ELCB and disconnect power cable from facility outlet or terminal.	29
23	CAUTION	Injury	Do not leave unit in a location where children may have access	29

## 2. COMPONENT NAMES AND FUNCTIONS

### External View

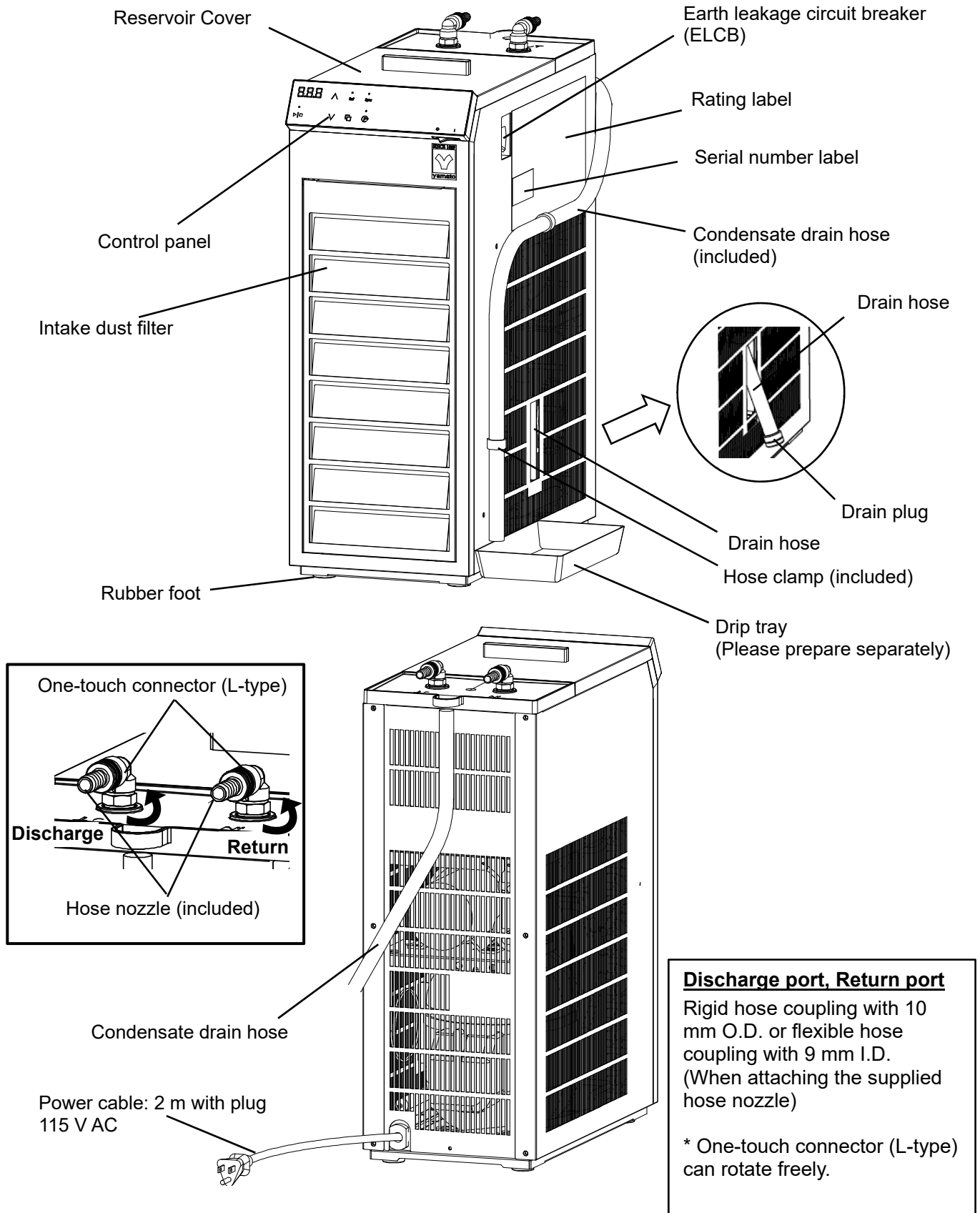

## 2. COMPONENT NAMES AND FUNCTIONS

### Circulation System

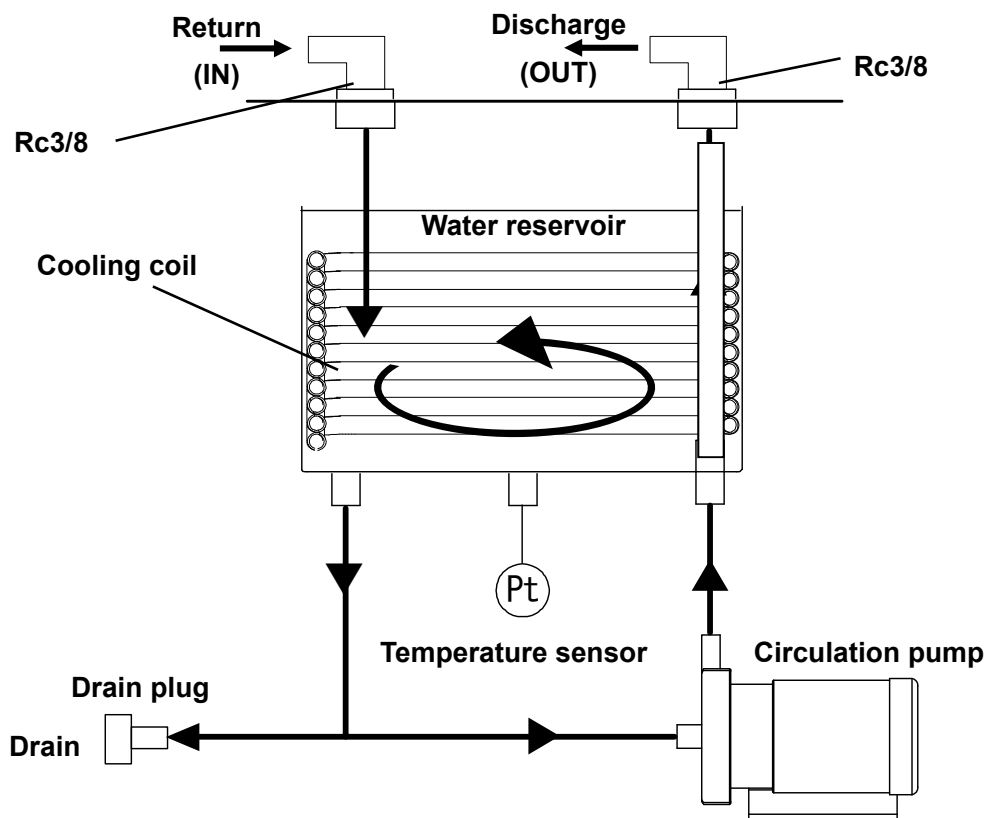

## 2. COMPONENT NAMES AND FUNCTIONS

### Control panel

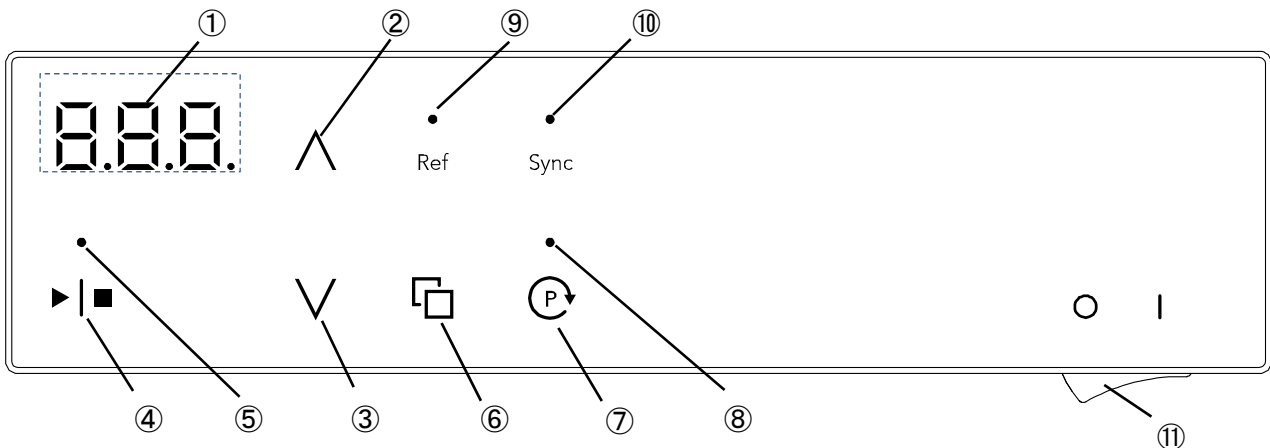

No.	Panel item	Description
①	Temperature display	Shows current temperature, temperature setting, parameters, etc.
②	Up key	Increases or decreases set value, scrolls items in user setting, and switches setting items.
③	Down key	
④	Run/Stop key	Press to start or stop cooling operation.
⑤	Run/ Stop lamp	Illuminates during cooling operation.
⑥	Set key	Press to switch screen between current temperature and temperature setting. Press and hold to switch screen to the user setting.
⑦	Pump key	Press to start or stop cooling water circulation.
⑧	Pump lamp	Illuminates during circulating operation.
⑨	Refrigerator lamp (Hereinafter Ref lamp)	Flashes when the compressor delay timer operates. Goes out when the timer ends after about three minutes. Illuminates while refrigerator is running.
⑩	Synchro lamp	Not used for this unit.
⑪	Power switch	Turn ON/OFF power.

### Display Characters

All characters displayed when making settings are defined as follows

Character	Letters	Description
CAL	CAL	Appears when entering offset temperature values. See "Calibration Offset" (P.21)
Pon	Pon	Appears when setting Auto-resume function. See "Auto-resume Function" (P.22)
PUP	PUP	Appears when setting the circulation pump operation on temperature limit alert. See "Selection of Circulation Pump Operation at Temperature Upper Limit Alert" (P.23)
dSP	dSP	Appears when setting LED brightness. See "LED Brightness Setting" (P.24)



# 3. PRE-OPERATION PROCEDURES

## Installation Precautions



### Choose an appropriate installation site.

DO NOT install unit:

- where installation surface is not completely level, not even or not clean.
- where flammable or corrosive gases/fumes may be present.
- where ambient temperature will exceed 35 °C, will fall below 5 °C or will fluctuate.
- where liquid is assumed to splash on unit
- in excessively humid or dusty locations.
- in direct sunlight or outdoors.
- where there is constant vibration.
- in direct contact with the outside air
- where power supply is erratic.
- where there is combustible material nearby.
- in the proximity of, in particular, directly below a fire alarm.
- where there is a risk of freezing or condensation.



Install unit in a location with sufficient space, as specified below.

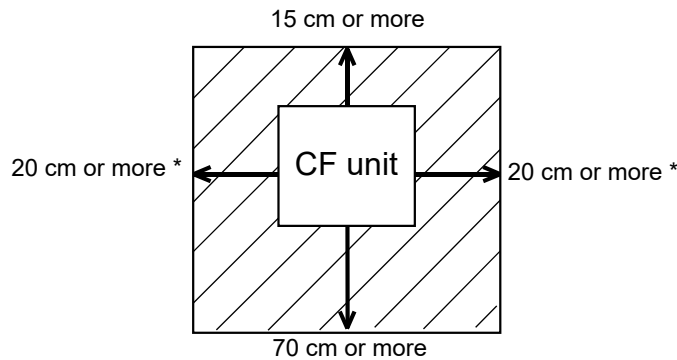

\* If unit is placed on either of the right and left walls, the other side shall be open at least 50 cm.

Operating unit in a location with poor ventilation (under a laboratory table, etc.), exhaust heat may be trapped and the cooling capacity may be greatly degraded. In this case, use an exhaust unit to dissipate the heat around unit. Estimated volume of exhaust\* is as follows.

Approximate amount of waste heat (kW)	0.6
* Approximate exhausts (m <sup>3</sup> /min)	2.0



### Use cargo-handling equipment for transportation and installation.

Use cargo-handling equipment for transportation and installation. Transport unit with sufficient number of people and an appropriate work method when carrying out manually.



### Install unit on a level surface.

Install unit on level and even surface. Failure to do so may cause abnormal vibrations or noise, possibly resulting in complications and/or malfunction.



### Take appropriate safety measures when installing.

Implement appropriate safety measures for the installation environment. Unit may tip over or fall, causing injury or death during an earthquake or other unforeseen incident.

# 3. PRE-OPERATION PROCEDURES

## Installation Precautions



### Always connect power cable to appropriate facility outlet or terminal.

Connect power cable to a suitable facility outlet or terminal, according to the electrical requirements.

Electrical requirements:	115V AC 7.5 A (ELCB capacity: 10 A)
--------------------------	-------------------------------------

Standard test conditions with no load should be as follows. Operational voltage range:  $\pm 10\%$ , Voltage range at which specified performance is guaranteed:  $\pm 10\%$ , Frequency rating:  $\pm 1\%$ .

\*Check the line voltage on distribution board and properly evaluate whether to utilize a line being shared by other equipment. If unit is not activated by turning on ELCB, take an appropriate course of action, such as connecting unit to a dedicated power source. Connecting multiple cables using a branch outlet or extension cord will cause voltage to drop, leading to degraded temperature control or malfunction.

#### Power cable, terminal processing

Standard	Cable end processing
3-core 2.0 mm <sup>2</sup> (*1)	With a plug

\* The length of power cable is about 2 m. \*1 Nominal cross-sectional area of conductor



### Install equipment in a well-ventilated place

Do not operate unit with ventilating openings on unit (front, side, rear) obstructed. Doing so may result in excessive temperatures inside the unit control panel, causing possible degraded CPU board performance, malfunction or fire.



### Install in a dry location.

Install unit where it will be free from liquid spray and other moisture. Failure to do so may result in control mechanisms becoming wet, causing malfunction, electric shock and/or fire.

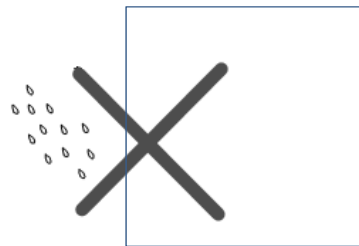



# 4. INSTALLATION PROCEDURES

## Installation Procedure

### 1. Hose connection

Connect hoses to the discharge port and return port of the cooling water circulation system. CF series units are an external closed loop circulation system.

Connection can be made with 10 mm O.D. rigid hose, or with 9 mm I.D. flexible hose. With optional nozzle attached, other hoses can be connected. Select an appropriate hose according to the purpose of equipment use.

Attach a 20-mesh filter to the return port if there is a risk of dust or foreign objects mixed into the circulating water returning from the external device. See Strainer set in "List of Options" (P.37)

#### • When using rigid hose with 10 mm O.D.

Put the supplied insert sleeve into rigid hose, and push the hose straight to the end while holding the connection port with hand. Failure to use the insert sleeve may lead to water leakage.

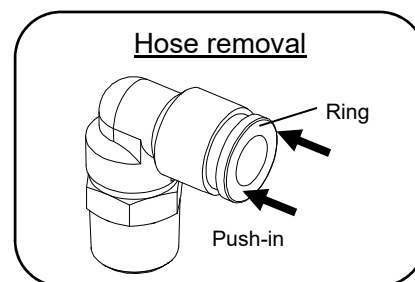
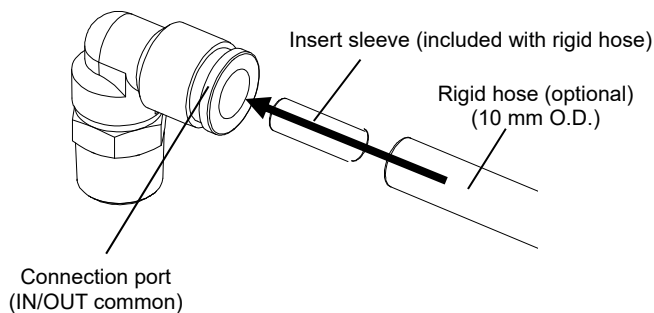

❖ To remove the hose, pull out the hose with the ring of the connection port pushed in.

#### • When using a flexible hose with 9 mm I.D.

1. Connect the flexible hose securely to the hose nozzle (included).
2. Push the hose nozzle straight to the end while holding the connection port with hand.
3. Secure the flexible hose with a hose clamp.

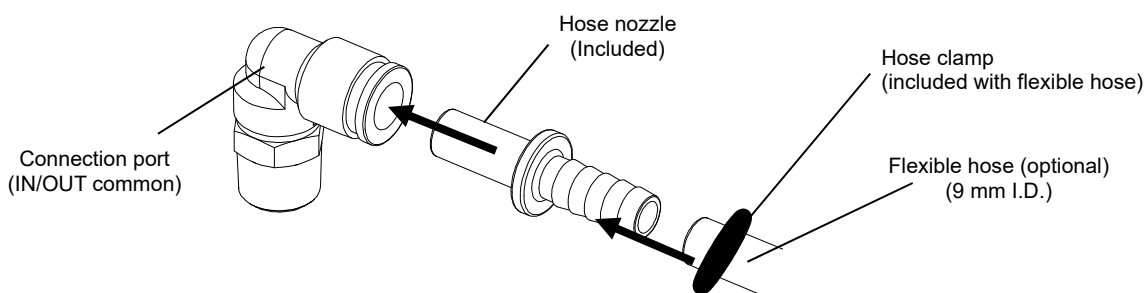

# 4. INSTALLATION PROCEDURES

## Installation Procedure

### 2. Hose connection to the external device

When a connection between unit and hose is made, connect to an external device as shown in the figure. Rotatable connector on the connection port allows free change in the direction. Adjust the direction so that the hose does not bend when connected to an external device.

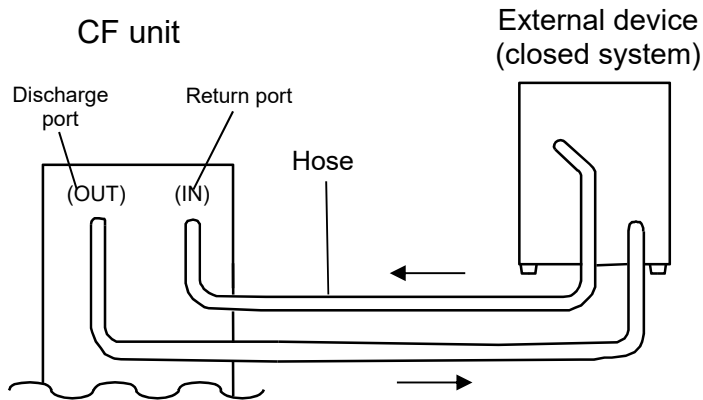

❖ As the standard specifications, both IN/OUT can be connected with fittings for a rigid hose with 10 mm O.D. and for a flexible hose with 9 mm I.D. when connected with included accessory.  
(Hoses are not included)

- ❖ Check the pump head of the circulation pump ( $0.1\text{MPa} \approx 10\text{ m}$ ) from the specification column and select a hose with sufficient pressure resistance. Use a hose clamp to secure the hose. See "List of Options" (P.37).
- Do not operate unit with the external circulation path shut.

### 3. External circulation path

- A variety of optional accessories are available to suit the piping system of external device and for a wide range of uses.
- Where the optional flow rate valve is installed (P.36 "List of options"), be sure to open it whenever running the circulation pump. Do not excessively restrict flow. Do not shut the external circulation path completely. Doing so may cause damage to the circulation pump. Ensure the minimum flow rate of 1 L/min.

- ❖ Operation of flow rate valve (optional)

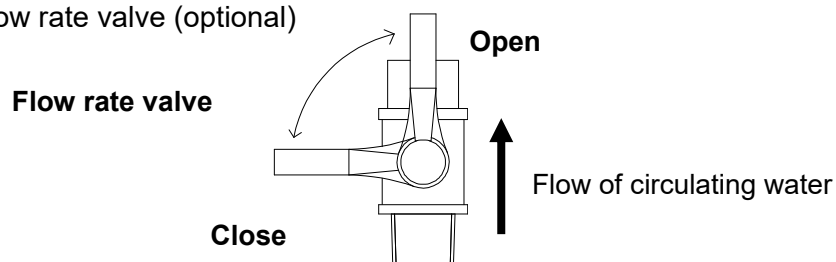

- Be sure that circulation lines are the minimum required lengths. Cooling efficiency is decreased while flow resistance increases in relation to longer circulation line length. See "11. SPECIFICATIONS" (P.33) for pump capacity.
- Be sure that the circulating water line forms circulation path. Do not connect circulation lines to gas or water plumbing lines.
- Check the specifications of the external devices (required flow rate, allowable pressure of piping) in order to avoid accident or equipment malfunction.
- Do not connect CF series unit to external devices with supplemental powering mechanisms.
- Always change the flow rate slowly. A sudden change in the flow rate may shorten the life of the circulation pump.
- Be careful not to let the circulating water flow backward when connecting to an external device located higher than CF unit. Backflow may cause overflow from the water reservoir.

# 4. INSTALLATION PROCEDURES

## Installation Procedure

### 4. Filling water reservoir

Select circulating water according to "Preparation of circulating water" (P.15)

1. Open the lid and let circulating water flow into the reservoir until the cooling coil is immersed.
2. In this state, turn ELCB ON (I) and press the Power switch to operate and begin liquid circulation.  
See "5. OPERATION PROCEDURES" (P.19)
3. The water level in the reservoir will decrease by the time circulating path is filled up. Add circulating water until the cooling coil is once again immersed.

❖ **Complete this work before operating the refrigerator.**

4. Turn off ELCB when circulating water is sufficiently supplied.
- ❖ When pouring circulating water, put it in gently without giving a momentum. Note that when the circulation pump stops, the water level in the reservoir will vary.
5. Replace reservoir cover.
- ❖ Do not open the cover unless otherwise necessary to prevent dust, foreign object, etc. from entering the reservoir.

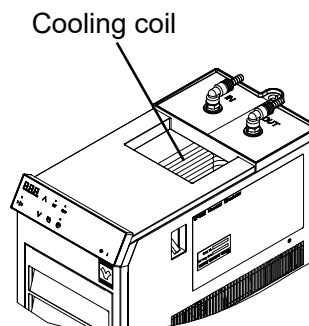

\* CF series units do not feature overflow system. Be careful not to overfill the reservoir.



**Use caution not to let circulating water spill over unit. Electric leakage or electric shock may result if the circulating water comes into contact with the electrical components. When circulating water spills on the control panel, wipe it dry with a clean dry cloth.**



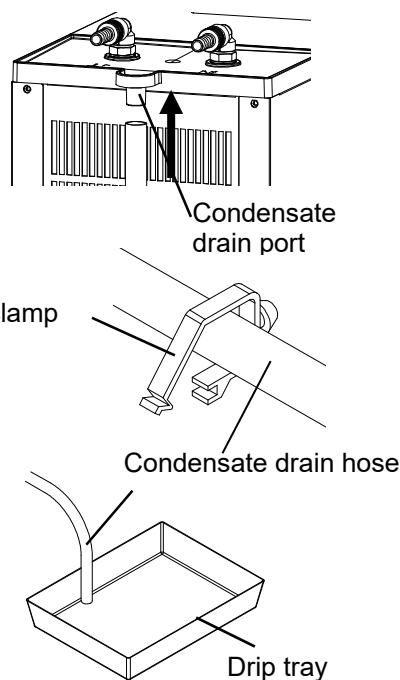

### 5. Installation of condensate drain hose

1. Connect the condensate drain hose to the condensate drain port on the back of unit.
  2. Insert two supplied hose clamps into the holes on the right side of unit. See "External view" (P.10) for locations.
  3. Draw the condensate drain hose through hose clamp and secure it.
  4. Prepare a drip tray.  
(Drip tray is not included and should be prepared separately)
  5. Draw the condensate drain hose into the drip tray.
- ❖ Drain and clean the drip tray on a regular basis.

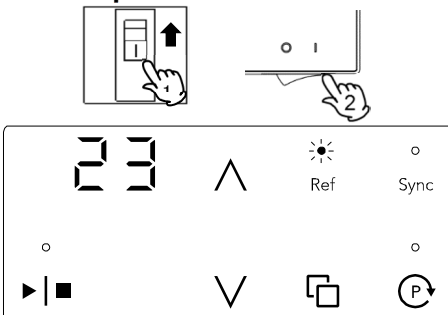
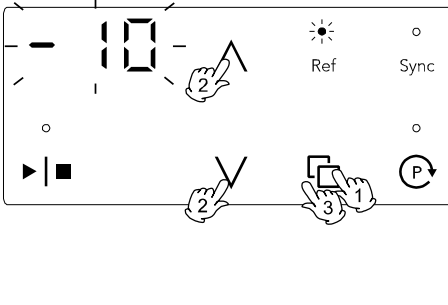

# 5. OPERATION PROCEDURES

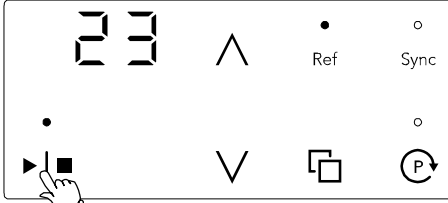
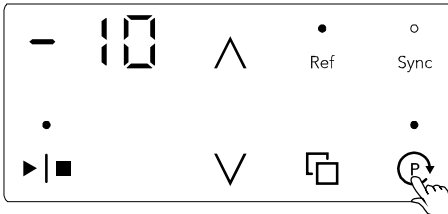

## Operation procedure

<p>1.</p>	<p><b>Turn on power</b></p> 	<p>1. Turn ELCB ON (I). 2. Turn the Power switch ON (I).</p> <p>Temperature display : Shows temperature reading following the software version "V. o.o" Ref lamp : Flashing (goes off after about three minutes) ☀ indicates flashing.</p>
<p>2.</p>	<p><b>Set temperature</b></p> 	<p>1. Press  key. Temperature display : Current set temperature flashes. 2. Set temperature using the <math>\wedge</math> <math>\vee</math> keys. 3. Press  key to finalize. Temperature display : Shows temperature reading display ❖ If not operated for about one minute while temperature setting is on screen, display reverts to the previous screen.</p>
<p>3.</p>	<p><b>Run refrigerator</b></p>  <p>Press 1 sec.</p>	<p>Press <math>\blacktriangleright</math> <math>\blacksquare</math> key for one second. Run/ Stop lamp : ON Ref lamp : ON Refrigeration unit : Run ❖ Refrigerator will operate when Ref lamp stops flashing &lt;To stop&gt; Press <math>\blacktriangleright</math> <math>\blacksquare</math> key again. Run/ Stop lamp : OFF Ref lamp : Flashing (goes off after about three minutes) Refrigeration unit : Stop</p> <p>❖ Ref lamp indicates the operating state of the refrigerator. OFF: Standby (ready for operation) ON: In operation Flashing: In preparation. It takes about three minutes from the refrigeration stop to restart operation for protecting the refrigerator.</p>
<p>4.</p>	<p><b>Start circulation</b></p>  <p>Press 1 sec.</p>	<p>Press  key for one second. Pump lamp : ON Circulation pump : Run &lt;To stop&gt; Press  key again. Pump lamp : OFF Circulation pump : Stop</p>
<p>❖ When changing temperature setting, in Step 2 while the value is flashing, cooling operation can start or stop. The setting change will be finalized with the value at the time of start or stop of the operation. It is also possible to start or stop cooling water circulation operation at the time of temperature setting change. Still setting value keeps flashing.</p> <p>Note) Always open the optional flow rate valve, if installed, at the discharge port when operating the circulation pump. See "3. External circulation path" (P.17)</p>		

# 5. OPERATION PROCEDURES

## User Setting

### List of user setting items

- Press and hold  key for three seconds. User setting items will be shown. Select an item using the  $\wedge$   $\vee$  keys. Press  key again to edit the displayed item.
- While the user setting item is displayed, leaving unit without key operation for about two minutes will discard the unconfirmed changes, and the display reverts to the previous screen.
- As with the case above, holding down for two seconds will finalize the setting and the display reverts to the previous screen.
- Only calibration offset function "CAL" can be set or altered during cooling operation (with Run/Stop lamp ON). The other setting items can only be set while both cooling and circulation operations are stopped (Run/Stop lamp and Pump lamp OFF).

Panel item	Description	Page
Calibration offset	Calibration offset is a function which can correct for any differences discovered between actual liquid temperature and the temperature displayed on the control panel. Offset function can correct to either the positive or negative side of the entire unit temperature range. Setting range: -5.0 to +5.0 °C Default setting is "0.0"	P.21
Auto-resume function	Select operation for the time power is restored. OFF: Unit goes into idle at power recovery. ON: Unit automatically reverts to status just before power loss and begin operation once again from that point. Default setting is "OFF"	P.22
Selection of the circulation pump operation at temperature upper limit alert	Select operation of the circulation pump when temperature upper limit alert is triggered. OFF: Circulation pump will remain in idle. ON: Circulation pump begins running with the pump key ON. Default setting is "ON"	P.23
LED brightness setting	Change the LED brightness of the control panel. The brightness can be set in 8 levels. Setting range: 0-7 Default setting is "3"	P.24

- ◆ By purchasing optional "external interlock input terminal" (model OCF96, product code 281484), the external interlock function setting can be made through user setting. See OCF96 instruction manual for setting and operation procedures.



# 5. OPERATION PROCEDURES

## Calibration offset

Calibration offset is a function which can correct for any differences discovered between actual liquid temperature and the temperature displayed on the control panel. Offset function can correct to either the positive or negative side of the entire unit temperature range.

- Run unit at desired temperature. Once temperature has risen and stabilized, gauge temperature of circulating water with a thermograph.
- Check the difference between the set temperature and the actual liquid temperature.

### Example

Actual temperature is lower than temperature reading by 2 °C:

Temperature reading can be calibrated by entering a calibration offset value of -2.0 to compensate against the actual temperature deficiency of 2 °C.

If the initial temperature reading was 20 °C, it will read 18 °C after offset calibration, and be brought into agreement with actual temperature.

#### 1. Enter user setting

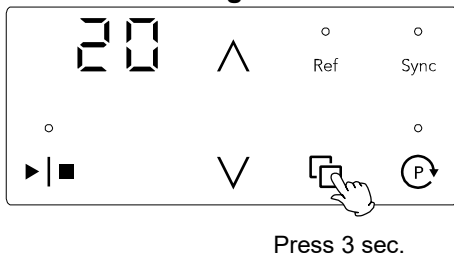

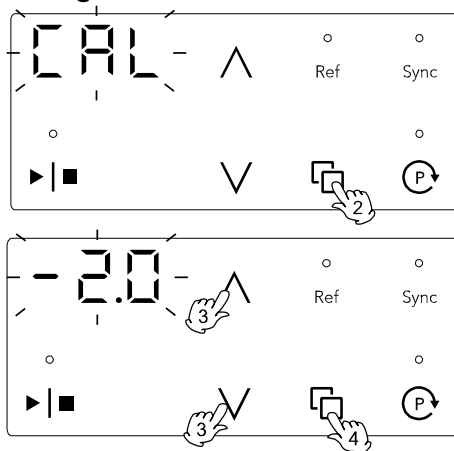

Turn power switch ON (I) and press  key for three seconds while temperature reading is on the screen. Unit enters user setting.

#### 2. Change offset value

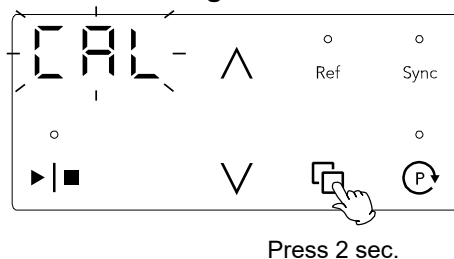

#### 3. Exit user setting



After completing the setting, press and hold key  for two seconds. Display reverts to initial screen and shows temperature reading.

# 5. OPERATION PROCEDURES

## Auto-resume function

### Select recovery mode for the event of a power failure.

OFF: Unit goes into idle at power recovery. (Default setting)

ON: Unit automatically reverts to status just before power loss and begin operation once again from that point.

(To protect refrigerator, refrigeration begins after about three minutes)

#### 1. Enter user setting

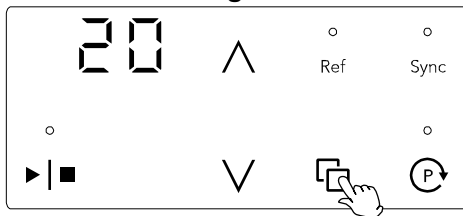

Press 3 sec.

Turn power switch ON (I) and press key for three seconds while temperature reading is on the screen. Unit enters user setting.

#### 2. Change the Auto-resume setting

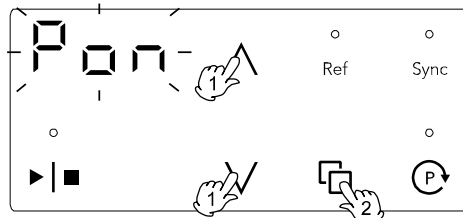

1. Select "Pon" using the  $\wedge$   $\vee$  keys.  
Temperature display: "Pon" flashes

2. Press key  
Temperature display: Current set value flashes.

3. Use the  $\wedge$   $\vee$  keys to alter the setting.

4. Press key to finalize.  
Temperature display: Set value is shown for about one second.

After completion, the screen returns to step 1.

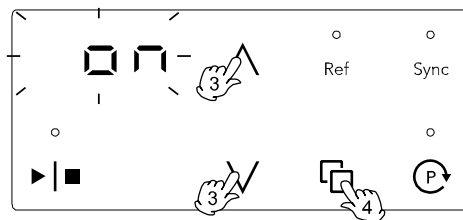

#### 3. Exit user setting

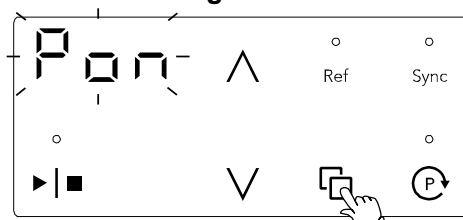

Press 2 sec.

After completing the setting, press and hold key for two seconds. Display reverts to initial screen and shows temperature reading.

# 5. OPERATION PROCEDURES

## Selection of circulation pump operation at temperature upper limit alert

Select the circulation pump operation for the time temperature upper limit alert (Hi) is raised and temperature reading exceeds 40 °C.

OFF: Circulation pump will remain in idle.

ON: Circulation pump begins running with the pump key ON. (Default setting)

### 1. Enter user setting

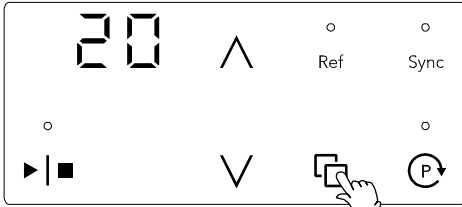

Press 3 sec.

Turn power switch ON (I) and press  key for three seconds while temperature reading is on the screen. Unit enters user setting.

### 2. Change the pump operation setting.

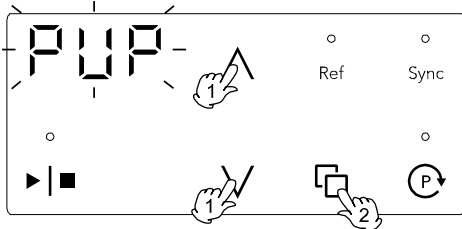

1. Select "PUP" using the  $\wedge$   $\vee$  keys.  
Temperature display: "PUP" flashes

2. Press  key  
Temperature display: Current set value flashes.

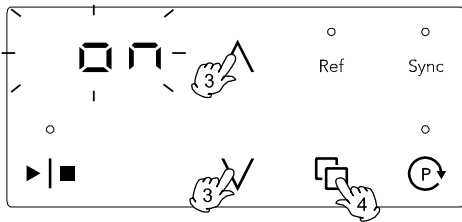

3. Use the  $\wedge$   $\vee$  keys to alter the setting.

4. Press  key to finalize.  
Temperature display: Set value is shown for about one second.

After completion, the screen returns to step 1.

### 3. Exit user setting

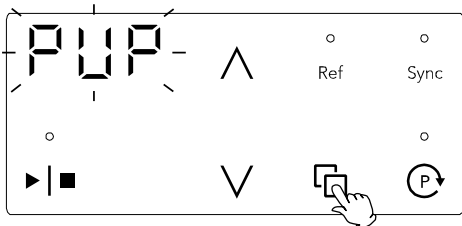

Press 2 sec.

After completing the setting, press and hold  key for two seconds. Display reverts to initial screen and shows temperature reading.

# 5. OPERATION PROCEDURES

## LED brightness setting

### Change the LED brightness of the control panel.

The brightness can be set in 8 levels from 0 to 7.

(Default setting: "3").

#### 1. Enter user setting

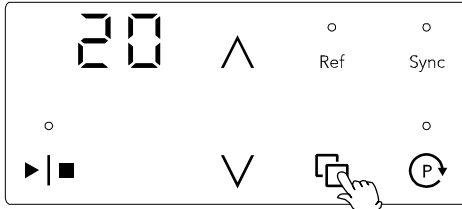

Turn power switch ON (I) and press  key for three seconds while temperature reading is on the screen. Unit enters user setting.

#### 2. Select the LED brightness level

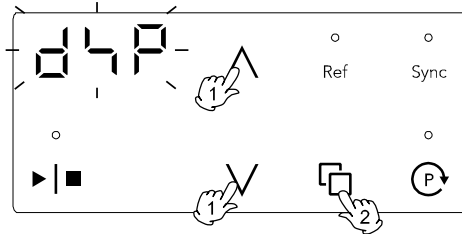

1. Select "dSP" using the  $\wedge$   $\vee$  keys.

Temperature display: "dSP" flashes

2.  $\textcircled{2}$  Press  key

Temperature display: Current set value flashes.

3. Use the  $\wedge$   $\vee$  keys to alter the setting.

4.  $\textcircled{4}$  Press  key to finalize.

Temperature display: Set value is shown for about one second.

After completion, the screen returns to step 1.

#### 3. Exit user setting

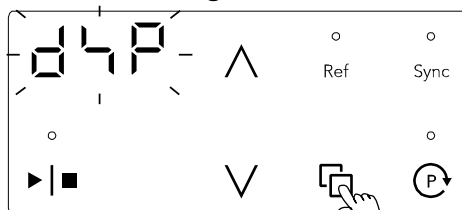

After completing the setting, press and hold  key for two seconds. Display reverts to initial screen and shows temperature reading.

## 6. HANDLING PRECAUTIONS

### Warnings and Cautions



CAUTION



#### **NEVER process explosive or flammable substances**



Never attempt to process explosives, flammables or any items which contain explosives or flammables. Fire or explosion causing serious injury or death may result. See "16. LIST OF HAZARDOUS SUBSTANCES" (P.41)



#### **DO NOT use harmful substances**

Never use test samples that are toxic or that generate noxious fumes, which may cause serious accident.



#### **DO NOT operate equipment when abnormalities are detected.**

If unit begins emitting smoke or abnormal odors for reasons unknown, turn off ELCB immediately, disconnect power cable from power supply, and contact original dealer of purchase for assistance. Failure to do so may result in fire or electric shock. Never attempt to disassemble or repair unit. Repairs should be always be performed by a certified technician.



#### **Wash water reservoir before use.**

Unit has been cleaned at the time of shipment. However, when unit is used for the first time or has been in storage for a long period of time, Fill the reservoir with tap water and drain to clean the reservoir and water lines.



#### **Overnight and extended storage.**

- Whenever unit is not in operation, stored overnight or put in storage, always turn ELCB OFF (○) and disconnect power cable.
- Drain circulating water from the reservoir and circulation lines by removing the drain plug if unit will be in storage for a long period of time. See "Changing circulating water" (P.27) Failure to do so may cause corrosion or clogging, resulting in equipment malfunction.



#### **ALWAYS run equipment within specified temperature range**

Operate unit within the temperature setting range specified in the specifications. Operating unit outside of specification range may result in equipment damage or malfunction.



#### **Power loss recovery**

The behavior of unit at the time of recovery from power failure can be set in user setting. See "Auto-resume function" (P.22) for details. (Default setting is "OFF")

## 6. HANDLING PRECAUTIONS

### Warnings and Cautions



#### **Circulation pump.**

- Never operate circulation pump dry. Damage or malfunction may result. Operating unit without circulating water in the reservoir and circulation pump may cause seizure of the pump and/or other problems.
- Keep water reservoir covered and do not allow any debris to enter and remain in the reservoir. Damage to the pump may result.
- Do not operate with the circulating path completely closed.
- Make sure that the flow rate of circulating water keeps at least 1 L/min.



#### **Refrigerator abnormal stop**

If room temperature and liquid temperature are high, or the intake dust filter is clogged, increasing the load of the refrigerator. The refrigerator high-pressure cut-off switch may operate and stop the refrigeration.



#### **Calibration offset**

If there is a deviation between actual temperature of the circulating water and temperature reading, and adjustment is necessary, refer to "Calibration offset" (P.21) to perform temperature correction.



#### **Inspect regularly.**

ELCB, in particular, is a key device in maintaining this unit safety, and must be inspected/maintained regularly. See "Inspection and Maintenance" (P.27)

# 7. MAINTENANCE PROCEDURES

## Inspection and Maintenance



- Be sure to disconnect power cable before conducting inspection and maintenance, unless otherwise necessary.
- Inspect and perform maintenance when unit and circulation water is at room temperature.
- Never attempt to disassemble unit.



- Clean unit using soft damp cloth. Never use benzene, paint thinner, scouring powder, scrubbing brush or other abrasives and solvents to clean unit. Superficial damage and/or discoloration, as well as deformity to some components may result.

### Check at each operation

Make sure that there is no leaks, abnormal noise and vibration while unit is running.

### Inspect monthly.

Inspect ELCB ON and OFF function.

Prepare unit for inspection by connecting power cable to a facility outlet or terminal.

- Confirm that ELCB is "OFF (O)", then turn it back "ON (I)".
- With ELCB "ON (I)", depress the test button on ELCB using a ball-point pen or other fine-tipped object. If ELCB shuts off, it is functioning normally.

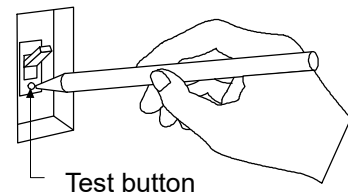

### Hose replacement

Ethylene propylene hose and silicone hose are used for the piping inside unit. Hoses may become discolored with time. Replacing hoses once every two years is recommended for safe use. Contact original dealer of purchase for requesting replacement.

### Pump replacement

Replace circulation pump by 8000-hour run or once every three years. Water may leak due to deterioration of seal components inside circulation pump. Contact original dealer of purchase for requesting replacement.

### Changing circulating water

Change circulating water entirely every three months for tap water/ethanol solutions or every six months for Nybrine<sup>®</sup> solutions. Observe local laws and regulations when disposing of Nybrine<sup>®</sup> and handle it in an appropriate manner.

Scale, algae and other substances may accumulate in circulation pump, if the above guidelines are not observed, resulting in decreased pump performance or equipment malfunction.

When changing circulating water, pull out the drain plug on the right side of unit, and discharge the water.

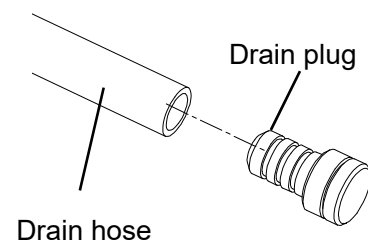

# 7. MAINTENANCE PROCEDURES

## Inspection and Maintenance

### Water reservoir maintenance

Remove any foreign substances and debris from water reservoir as frequently as possible.  
Failure to do so may cause damage to circulation pump.  
Wear proper gloves when performing reservoir maintenance.

### Cleaning intake dust filter.

A clogged intake dust filter will degrade cooling performance and may result in refrigeration system malfunction. Clogging degree of the intake dust filter varies depending on operating time and environment. Be sure to periodically clean or replace filter.

The filter mounting plate is fixed with a magnet, pull it to the near side to detach.  
Remove dust from the intake dust filter and condenser fins with a vacuum cleaner, etc.

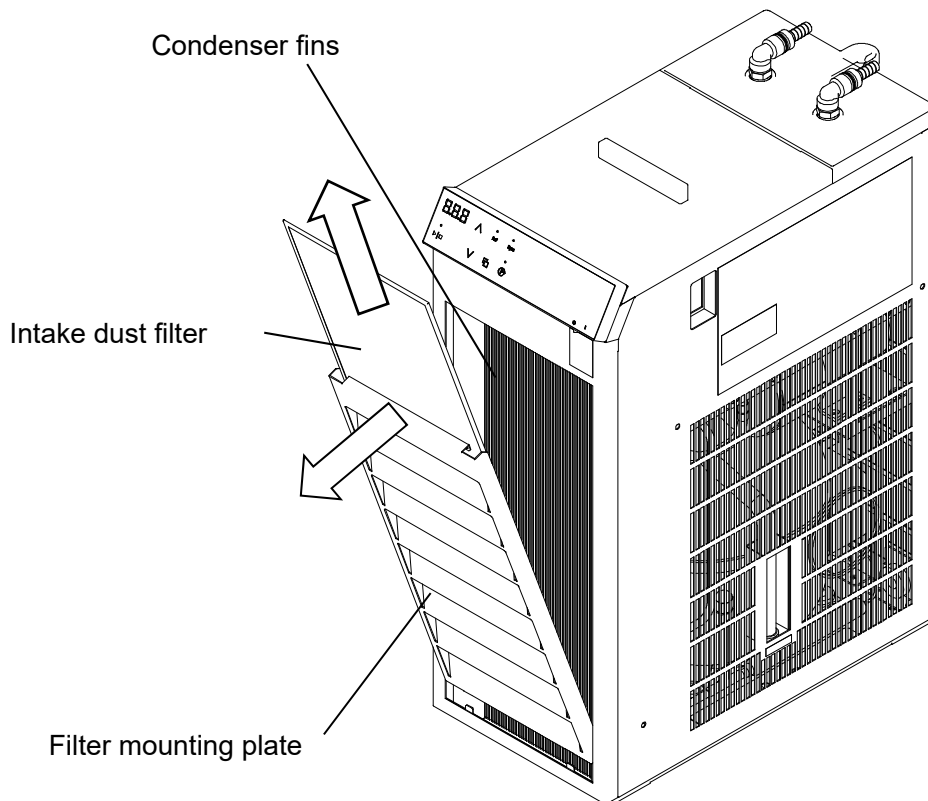

Note: Condenser fins are soft and likely to warp. Handle them carefully.  
Edges of condenser fins are very sharp. Do not contact with bare hands or skin. Cuts and injuries may result.

◆ Contact original dealer of purchase, if further questions arise concerning maintenance procedures.



# 8. EXTENDED STORAGE AND DISPOSAL

## Extended Storage/Unit Disposal

<b>⚠ WARNING</b>	<b>⚠ CAUTION</b>
<b>Extended storage</b> <ul style="list-style-type: none"> <li>● Turn off ELCB and disconnect power cable from facility outlet or terminal.</li> <li>● Drain circulating water. When tap water is used, algae may develop inside the piping, or water may freeze and break wetted parts if the room temperature falls below freezing point.</li> </ul>	<b>Disposal</b> <ul style="list-style-type: none"> <li>● CFC substitute (R-404A) is used for this unit. Request the assistance of a professional.</li> <li>● Do not leave unit unattended, or in reach of children.</li> </ul>

## Disposal Considerations

Dispose of this unit in accordance with local laws and regulations. Dispose of or recycle this unit in a responsible and environmentally friendly manner.

- Yamato Scientific Co., Ltd. strongly recommends disassembling unit, as far as is possible, in order to separate parts and recycle them in contribution to preserving the global environment. Major components and materials, comprising CF unit are listed in the table below

Component Name	Material
<b>Main Unit Components</b>	
Exterior	Chrome-free electro-galvanized steel sheet metal printing coating
Water reservoir	Stainless steel
Insulation material	Chloroprene, polyethylene
Circuit boards	Polyethylene (PET) resin film
Refrigeration unit Refrigeration piping	Composite of iron, copper, stainless steel and other materials
Water piping system	Reservoir: SS304, cooling coil: C1220T + Ni Fittings: SS304, C3604 + Ni, PP Hoses: Si (clear)
Circulation pump	Composite of iron, aluminum, stainless steel, PPO, copper, and other materials
Fan motor	Composite of aluminum, iron, stainless steel, copper, and other materials
<b>Electrical Parts</b>	
Switches and relays	Composite of resin, copper and other materials
Control panel	Polycarbonate resin
Circuit boards	Composite of fiber glass and other materials
Power cable	Composite of synthesized rubber coating, copper, nickel and other compounds
Wiring material	Composites of fiberglass, fire-retardant vinyl, copper, nickel and other compounds
Seals	Resin material
Sensor (Pt100Ω)	Stainless steel, etc.

# 9. TROUBLESHOOTING

## Error Codes

Unit has a self-diagnostic function built into the CPU board and a separate safety device, independent of the CPU board.

The table below shows possible causes and measures to take when safety device is triggered.

### [Error Codes]

If an abnormality occurs, the following error code and measured temperature are displayed alternately on the screen, and operation stops. Confirm the error code, terminate operation and turn OFF (○) ELCB immediately.

Display code	Error description	Possible causes & measures
E 0 1	Temperature sensor error (E01)	<ul style="list-style-type: none"> <li>● Controller failure</li> <li>● Temperature sensor failure (disconnection or short circuit)</li> <li>● Temperature out of specification range.</li> </ul> Contact original dealer of purchase.
E 0 6	Temperature upper limit error Temperature lower limit error (E06)	<ul style="list-style-type: none"> <li>● Circulating water temperature error</li> </ul> Unit detects abnormality and terminates operation when the temperature reading rises over 60 °C or falls below -25 °C, Turn off the ELCB and wait until the liquid temperature comes within the appropriate ranges: -20 to 30 °C, and restart operation. If unit does not reset, contact original dealer of purchase.
E 1 3	Refrigerator error (E13)	<ul style="list-style-type: none"> <li>● Refrigerator overload</li> <li>● Refrigerator failure</li> </ul> Turn OFF (○) ELCB. Wait until refrigerator sufficiently cools down, and then restart operation. Make sure that the ambient temperature is lower than 35 °C. Check intake dust filter and condenser fins for clogging, and clean dust off if accumulated. See "Cleaning intake dust filter." (P.28) for cleaning method and precautions. If unit does not reset, contact original dealer of purchase.
E 1 5	EEPROM error (E15)	<ul style="list-style-type: none"> <li>● Error in a storage element EEPROM on the controller board</li> </ul> Turn OFF (○) ELCB and restart unit. If unit does not reset, contact original dealer of purchase.

### • Other warnings (displayed alternately with temperature reading)

Display alert	Alert description	Possible causes & measures
L o	Temperature lower limit alert (Lo)	<ul style="list-style-type: none"> <li>● Alert is displayed when temperature reading falls below -22 °C, and continues operation. Contact original dealer of purchase if temperature continues to significantly decrease after alert occurs.</li> </ul>
H i	Temperature upper limit alert (Hi)	<ul style="list-style-type: none"> <li>● Alert is displayed when temperature reading exceeds 32 °C, and continues operation.</li> <li>● Unit terminates cooling operation when temperature becomes 40 °C or higher, and operates cooling water circulation operation according to the setting of "PUP" in the user setting.</li> </ul> Refrigerator may be overloaded and unit may perform abnormal stop to protect refrigerator. Always operate unit in the proper liquid temperature range of -20 to 30 °C. When abnormal stop occurs, turn OFF (○) ELCB and wait until liquid temperature falls sufficiently, then start it up again. If problem persists, contact original dealer of purchase for assistance.

# 9. TROUBLESHOOTING

## Troubleshooting Guide

Symptom	Possible causes	Possible measures
Display is blank when ELCB and the Power switch are turned ON (I).	<ul style="list-style-type: none"> <li>● Power supply failure</li> <li>● ELCB failure</li> <li>● Power switch failure</li> <li>● Controller failure</li> </ul>	<ul style="list-style-type: none"> <li>● Check power supply voltage (must be 115 V AC <math>\pm</math>10%)</li> <li>● Replace relevant parts</li> </ul>
Temperature does not rise.	<ul style="list-style-type: none"> <li>● No-load operation</li> </ul>	<ul style="list-style-type: none"> <li>● Operate unit with an external load since unit does not have heating function.</li> </ul>
Temperature does not fall	<ul style="list-style-type: none"> <li>● Refrigerator failure</li> <li style="padding-left: 20px;">Clogging of condenser fins</li> <li>● External temperature is high</li> </ul>	<ul style="list-style-type: none"> <li>● Clean intake dust filter and condenser fin (P.28). Installation Precautions (P.13)</li> </ul>
Temperature does not fall when the Run/Stop key is ON	<ul style="list-style-type: none"> <li>● Compressor delay timer is in operation</li> <li>● Excessive external load</li> <li>● External temperature is exceeding 35 °C</li> <li>● Condenser is clogged with dust, etc.</li> </ul>	<ul style="list-style-type: none"> <li>● Wait until the Ref lamp stops flashing (about three minutes from the start of flashing)</li> <li>● Reduce the external load</li> <li>● Operating ambient temperature range is 5 to 35 °C</li> <li>● Clean intake dust filter and condenser fins</li> </ul>
	<ul style="list-style-type: none"> <li>● Power supply failure</li> <li>● Temperature sensor failure</li> <li>● Controller failure</li> <li>● Relay failure</li> <li>● Refrigerator failure</li> </ul>	<ul style="list-style-type: none"> <li>● Check power supply voltage (must be 115 V AC <math>\pm</math>10%)</li> <li>● Replace relevant parts</li> <li>● Repair or replace relevant parts</li> </ul>
Circulation will not begin when the Pump key is ON	<ul style="list-style-type: none"> <li>● Malfunction due to idle operation or overload operation of circulation pump</li> <li>● Circulation pump thermal stop occurs due to excessive pressure loss at the external device or valve shut-off operation (temporary)</li> </ul>	<ul style="list-style-type: none"> <li>● Replace relevant parts</li> <li>● Open discharge valve (when flow rate valve is installed)</li> </ul>

### Requests for Repair

If abnormalities remain after confirming "Troubleshooting Guide", terminate operation, turn off controller and ELCB, and disconnect power cable. Contact original dealer of purchase for assistance.

The following information is required for all repairs.

- Product Name
  - Model
  - Serial Number
  - Date (year/month/day) of Delivery
  - Description of problem in as much detail as possible
- } Refer to warranty card.
- Repair this equipment for free of charge according to the contents on warranty card.  
Warranty period is 1 (one) year from date of purchase.
  - Consult with original dealer of purchase or Yamato sales office for any repair after warranty ended.  
Charged repair service of this equipment will be available on customer's request when it can be maintained functional by its repair.

\* Be sure to present warranty card to the service representative.

### Guaranteed Supply Period for Repair Parts

Guaranteed maximum supply period for repair parts is 7 (seven) years from date of discontinuation for this equipment.

"Repair parts" is defined as components which, when installed, allow for continued unit operation.

# 11. SPECIFICATIONS

Product Name		Neocool® circulator
Model		CF302L-A
System/circulating water		Closed circulation/tap water, antifreeze solution (below 10 °C)
Operating ambient temperature range		5 to 35 °C
Performance	Temperature setting range *1	-20 to 30 °C
	Temperature control accuracy (JTM K05) *2	±1.0 °C (≥ 0 °C) ±1.5 °C (< 0 °C)
	Temperature fluctuation (JIS) *2	3.0 °C (≥ 0 °C) 4.0 °C (< 0 °C)
	Cooling capacity (liquid temp) *2	Approx. 420 W (at 10 °C) Approx. 280 W (at -10 °C)
	Max. flow rate *3	Approx. 10 L/min
	Max. head *3	Approx. 5.7 m
Configuration	Temperature control system	Refrigerator ON-OFF
	Temperature sensor	Pt100Ω
	Controller	White LED digital display, key entry, minimum digit of 1 °C
	Refrigeration system/Rated performance/Refrigerant	Air-cooling/450 W/R404A
	Cooling coil	Copper/Nickel plating
	External circulation connection port	Rear top panel, single line
		One-touch connector (swivel type, L-type) Flow rate valve (optional)
Circulation pump	15W	
Safety functions		Overcurrent ELCB, temperature sensor failure, temperature upper/lower limit alert, temperature upper/lower limit error, refrigerator high-pressure cut-off switch, fan motor protection, circulation pump protection, delay timer for refrigerator protection
Other functions		Drain hose, condensate drain hose, Intake dust filter, cooling operation key, circulating pump key, calibration offset, Auto-resume function
Standard	Reservoir material Capacity (liquid volume)	Stainless steel Approx. 3.9 L (3.5 L)
	External dimensions (including protrusions)	W205 × D396 × H535 mm (W225 × D434 × H564 mm)
	Power supply	Single phase 115 V AC
	Current (ELCB capacity)	7.5 A (10A)
	Power cable	2 m with a plug
	Weight	Approx. 31 kg
Accessories		Instruction manual (1), Warranty card (1) Condensate drain hose(1 m)(1), Hose clamp (2) Hose nozzle (for flexible hose connection)(2)

\*1 Unit does not feature heating function. Depending on the ambient temperature or connection conditions, temperature may not reach -20 °C.

\*2 Performance based on 115 V AC supplied power and 20 °C ambient temperature.  
Temperature control accuracy and Temperature fluctuation are standards calculated according to JTM K05 and JIS respectively.

\*3 Pump performance based on tap water at 20 °C

# 12. REFERENCE DATA

## Cooling Capacity Curve



The following graphs show cooling capacities and characteristics.

Findings may vary with sample quantity, ambient temperature, individual differences and other factors. Use graph values as reference only.

### Analysis provisions

- Room temperature measurement: at the center of condenser inlet
- Circulating water: 60% dilution of Nybrine® Z1
- Power supply: 115 V AC

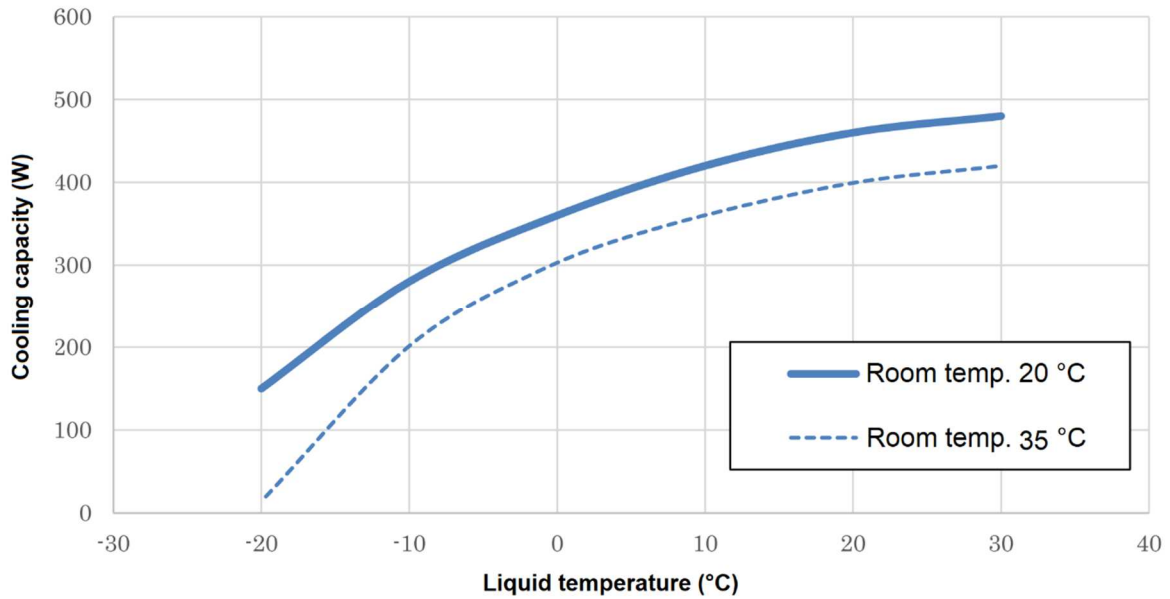

## Cooling Curve

### Analysis provisions

- Room temperature: 23 °C
- Circulating water: 60% dilution of Nybrine® Z1
- Power supply: 115 V AC
- Liquid volume: 3.5 L

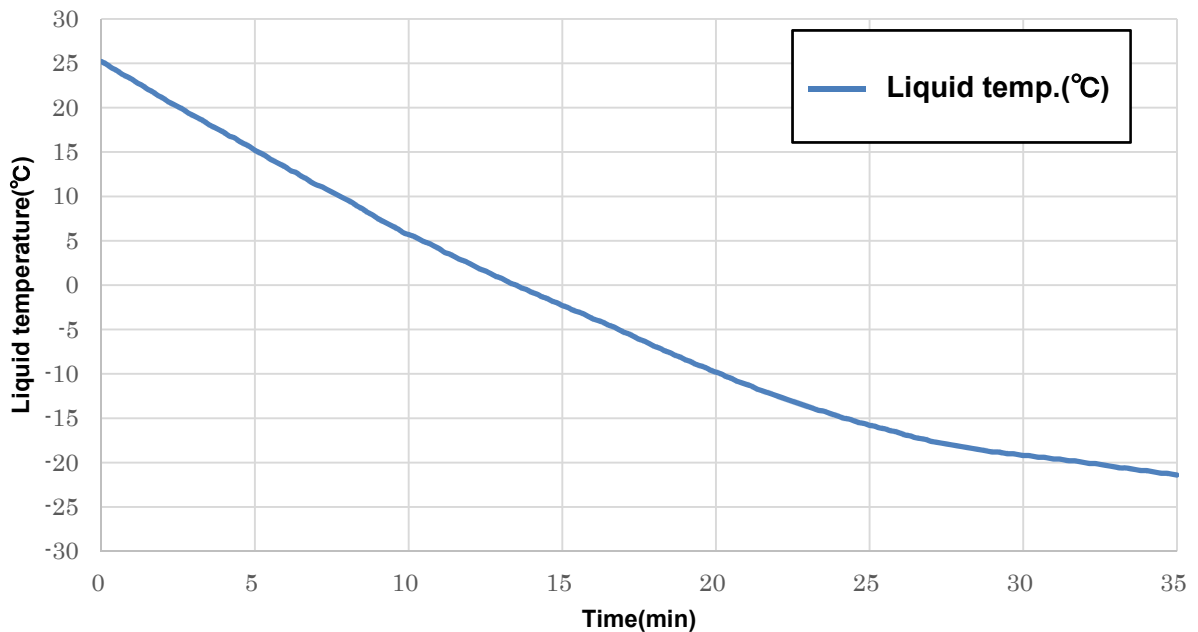

# 12. REFERENCE DATA

## Pump Performance Curve



The following graph shows the pump performance curve.

Findings may vary with sample quantity, ambient temperature, individual differences and other factors. Use graph values as reference only.

Analysis provisions

- Room temperature: 23 °C
- Circulating water: 20 °C tap water, 60% dilution of Nybrine® Z1
- Power supply: 115 V AC

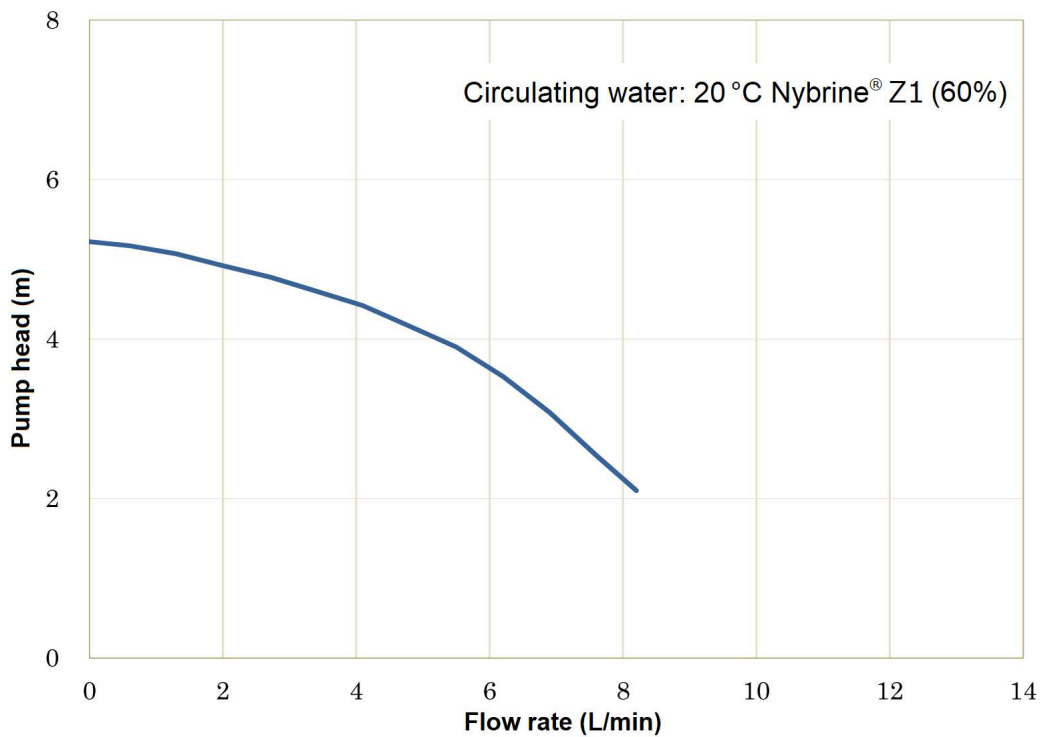
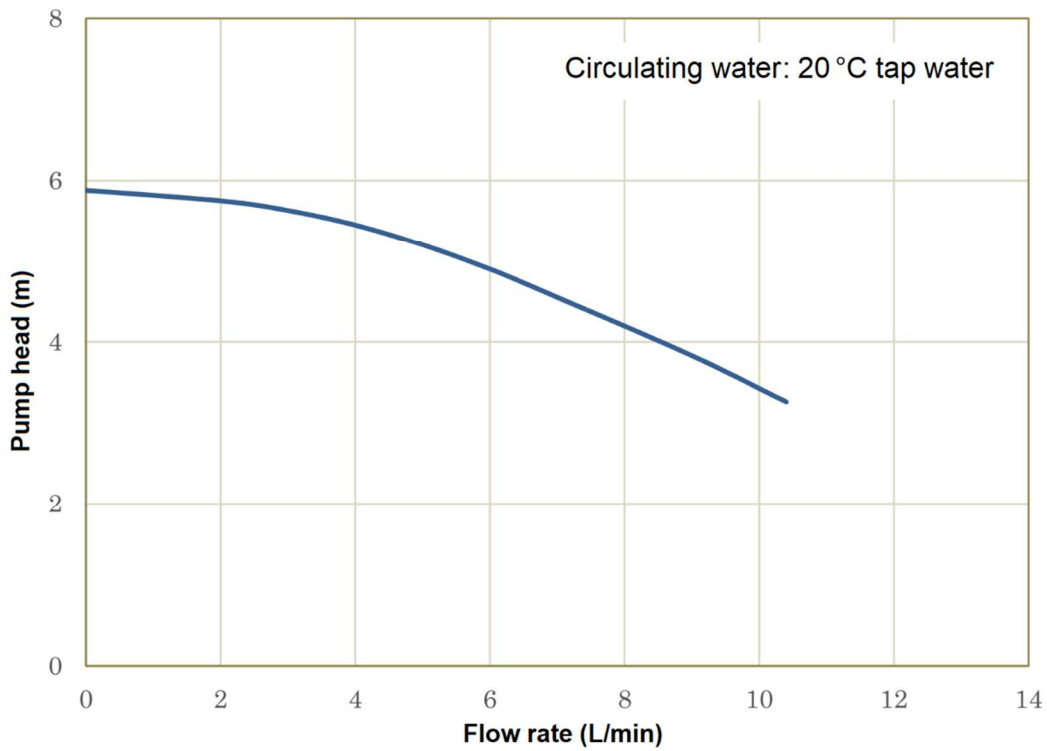

# 13. OPTIONAL ACCESSORIES

## List of Options

A variety of optional accessories are available to suit the piping system of external device and for a wide range of uses.

Contact original dealer of purchase for requests for options.

### Circulation connection components (fittings)

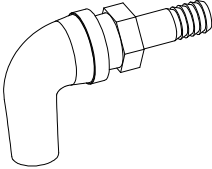
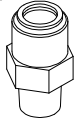
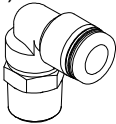
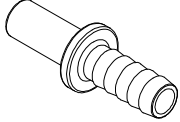
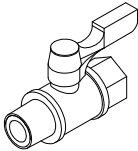
Product Name	Product code	Description	Contents
L-type circulation nozzle 	281476	Used to connect the circulation ports IN/OUT and flexible hoses. Select a fitting according to the inner diameter of the circulation hose to be used. * When connecting with hoses, be sure to secure the hose with a hose clamp (sold separately).	Standard: $\phi 8$ mm R3/8 Material: Stainless steel 1 pc
	221396		Standard: $\phi 10.5$ mm R3/8 Material: Stainless steel 1 pc
	221397		Standard: $\phi 13$ mm R3/8 Material: Stainless steel 1 pc
	221398		Standard: $\phi 16$ mm R3/8 Material: Stainless steel 1 pc
One-touch connector (straight) 	281480	Usable liquid temperature range: -20 to 60 °C * No freezing of circulating water Usable pressure: 1.0 MPa or less	Standard: 10 mm O.D. R3/8 For rigid hoses 1 pc
One-touch connector (L-type) 	281481	Usable liquid temperature range: -20 to 60 °C * No freezing of circulating water Usable pressure: 1.0 MPa or less	Standard: 10 mm O.D. R3/8 For rigid hoses Swivel type 1 pc
Hose nozzle 	281483	Usable liquid temperature range: -20 to 65 °C * No freezing of circulating water Usable pressure: 1.0 MPa or less (below 20 °C) 0.7 MPa or less (20 to 65 °C)	Standard: 9 mm I.D. For flexible hoses Connector receptacle 10 mm O.D. Material: Polyacetal 1 pc
Flow rate valve 	281477	Usable liquid temperature range: -20 to 80 °C * No freezing of circulating water Usable pressure: 0.98 MPa or less	Standard: R3/8 × Rc3/8 1 pc



# 13. OPTIONAL ACCESSORIES

## List of Options

### Circulation connection components (hoses)

Product Name	Product code	Description	Contents
Thermal insulation hose	221581	Usable temperature range: -20 to 80 °C * No freezing of circulating water Usable pressure: 0.2 MPa or less (below 40 °C) 0.1 MPa or less (40 to 80 °C)	Standard: $\phi 9$ mm $\times$ $\phi 13$ mm $\times$ 2 m (insulation: 28 mm O.D.) 2 pc Hose clamp 4 pc Thermal insulation tape 1 m Material (wetted part): Ethylene propylene
Thermal insulation hose	221599	Usable temperature range: -20 to 80 °C * No freezing of circulating water Usable pressure: 0.2 MPa or less (below 40 °C) 0.1 MPa or less (40 to 80 °C)	Standard: $\phi 9$ mm $\times$ $\phi 14$ mm $\times$ 2 m (insulation: 41 mm O.D.) 2 pc Hose clamp 4 pc Thermal insulation tape 1 m Material (wetted part): Silicon
Thermal insulation hose	281475	Usable temperature range: -20 to 60 °C * No freezing of circulating water Usable pressure: 0.6 MPa or less (below 20 °C) 0.5 MPa or less (20 to 40 °C) 0.4 MPa or less (40 to 60 °C)	Standard: Rigid hose with 10 mm O.D. $\times$ 2 m (insulation: 22 mm O.D.) 2 pc Inner collar Thermal insulation tape 2 pc Insulation hose piece 1 m Material (wetted part): 0.5 m polyurethane.

- ◆ Cut the thermal insulation tape and the insulation hose piece to the required length, and apply them to the connection.

### Circulation connection components (strainers)

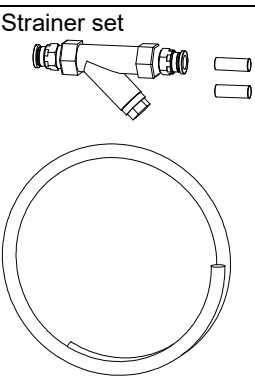
Product Name	Product code	Description	Contents
Strainer set 	281482	Removes dust in circulating water. Install right behind the outlet of unit. Usable liquid temperature range: 10 to 60 °C * No freezing of circulating water Usable pressure: 0.6 MPa or less (below 20 °C) 0.5 MPa or less (20 to 40 °C) 0.4 MPa or less (40 to 60 °C)	Standard: 20 mesh Y-strainer R3/8 1 pc Connection port: Straight one-touch connector 2 pc 10 mm O.D. 2 pc Inner collar 1 pc Polyurethane tube

# 13. OPTIONAL ACCESSORIES

## List of Options

### External interlock input terminal

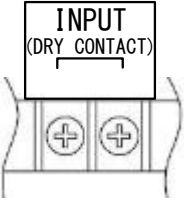
Product Name	Product code	Description
External interlock input terminal 	281484	Unit will be shipped with the terminal block (2P) attached to the rear of unit. This function is to start and stop cooling operation + circulation operation, or only circulation operation of unit by external control input (no-voltage a contact input). Control contact open: operation stop Control contact short circuited: operation start



Refer to the Instruction manual for each option for details such as operation and connection procedures.

# 14. WIRING DIAGRAM

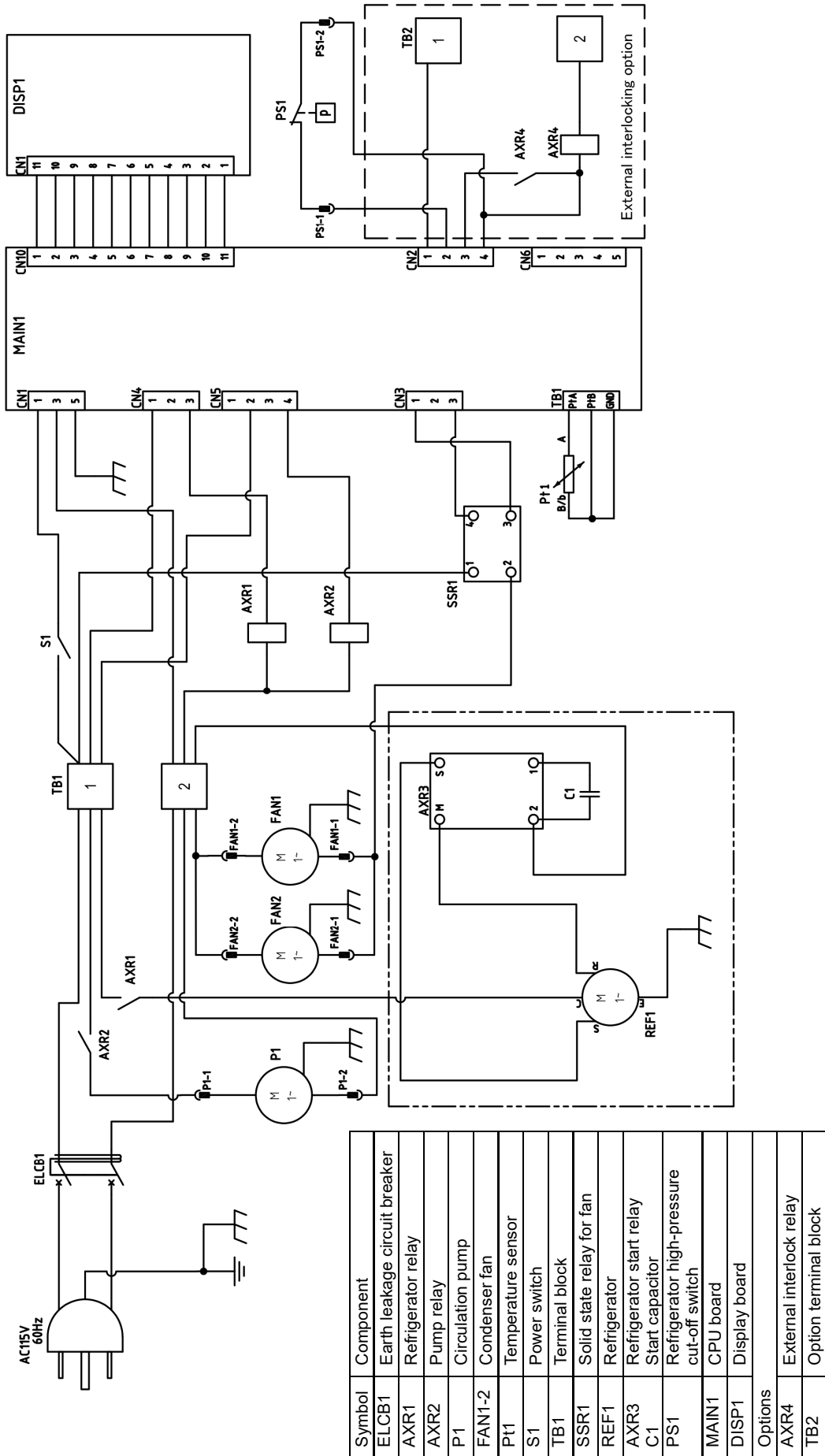

CF302L-A

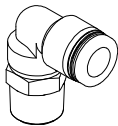
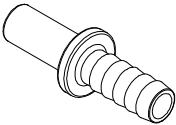
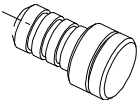

## 15. REPLACEMENT PARTS LIST

Part name		Part code	Standard	Manufacturer
One-touch connector (L-type)		LT00039314	R3/8	Yamato Scientific
Hose nozzle		LT00039316	10 mm O.D. connectors for flexible hose with 9 mm I.D.	Yamato Scientific
Intake dust filter		CF30243000	Front air intake	Yamato Scientific
Drain plug		CF30241060	For 12 mm I.D. hose	Yamato Scientific
Silicon hose		LT00007489	φ12 × φ16 mm 1.0 m Condensate drain hose (Included)	Yamato Scientific

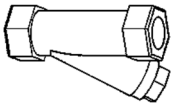
### Options

<b>【Strainer set】</b>				
Strainer		LT00036771	20 mesh	Yamato Scientific
Inner collar		LT00039454	Applicable hose: φ6.5 × φ10 mm	Yamato Scientific

## 16. LIST OF HAZARDOUS SUBSTANCES



Never attempt to process explosives, flammables or any items which contain explosives or flammables.

Explosive substances	①Nitroglycol, Glycerine trinitrate, Cellulose Nitrate and other explosive nitrate esters
	②Trinitrobenzen, Trinitrotoluene, Picric Acid and other explosive nitro compounds
	③Acetyl Hydroperoxide, Methyl Ethyl Ketone Peroxide, Benzoyl Peroxide and other organic peroxides
	④Metallic Azide, including Sodium Azide, etc.
Combustible substances	①Metal "Lithium" ②Metal "Potassium" ③Metal "Natrium" ④Yellow Phosphorus ⑤Phosphorus Sulfide ⑥Red Phosphorus ⑦Phosphorus Sulfide ⑧Celluloids, Calcium Carbide (a.k.a, Carbide) ⑨Lime Phosphide ⑩Magnesium Powder ⑪Aluminum Powder ⑫Metal Powder other than Magnesium and Aluminum Powder ⑬Sodium Dithionous Acid (a.k.a., Hydrosulphite)
	①Potassium Chlorate, Sodium Chlorate, Ammonium Chlorate, and other chlorates
	②Potassium Perchlorate, Sodium Perchlorate, Ammonium Perchlorate, and other perchlorates
	③Potassium Peroxide, Sodium Peroxide, Barium Peroxide, and other inorganic peroxides
	④Potassium Nitrate, Sodium Nitrate, Ammonium Nitrate, and other nitrates
Oxidizing substances	⑤Sodium Chlorite and other chlorites
	⑥Calcium Hypochlorite and other hypochlorites
Flammable substances	①Ethyl Ether, Gasoline, Acetaldehyde, Propylene Chloride, Carbon Disulfide, and other substances having ignition point of 30 or more degrees below zero.
	②n-hexane, Ethylene Oxide, Acetone, Benzene, Methyl Ethyl Ketone and other substances with ignition point between 30 degrees below zero and less than zero.
	③Methanol, Ethanol, Xylene, Pentyl n-acetate, (a.k.a. amyl n-acetate) and other substances having ignition point of between zero and less than 30 degrees.
	④Kerosene, Light Oil, Terebinth Oil, Isopenthyll Alcohol (a.k.a. Isoamyl Alcohol), Acetic Acid and other substances having ignition point of between 30 degrees and less than 65 degrees.
Combustible gas	Hydrogen, Acetylene, Ethylene, Methane, Ethane, Propane, Butane and other gases combustible at 15°C, ambient air pressure.

# 17. STANDARD INSTALLATION MANUAL

\* Install this equipment according to following format (check options and special specifications separately).

Model	Serial Number	Installation Date	Charged Personnel or Company Name for Installation	Installation proved by	Judgment

№	Item	Implementation method	Chapter № & Reference page of instruction manual	Judgment
<b>Specifications</b>				
1	Accessories	Quantity check according to the accessories column	11. SPECIFICATION P.33	
2	Installation	- Visual check of surrounding conditions Caution: Take care for environment - Securing a space	3. PRE-OPERATION PROCEDURES -Choose an appropriate... P.13	
		- Fill water reservoir with circulating water.	4. INSTALLATION PROCEDURES -Installation Procedure P.16-18	
<b>Operation-related matters</b>				
1	Power supply voltage	- Measure line voltage (power distribution board of facilities, outlet etc.) with a tester. - Measure line voltage during operation (must meet required voltage). Caution: Use a compliant device to install	3. PRE-OPERATION PROCEDURES -Ground wire MUST ... P.3 -Always connect power cable to... P.14 11. SPECIFICATIONS -Standard-Power Supply P.33	
2	Starting operation	- Start operation. Check that circulating water is flowing properly. Set at 10 °C and check the stabilization state. Caution: No water leakage	4. INSTALLATION PROCEDURES -Installation Procedure P.16-18 5. OPERATION PROCEDURES P.19-24	
<b>Description</b>				
1	Operational descriptions	Explain operations of each component and handling precautions according to instruction manual.	1. SAFETY PRECAUTIONS P.1-41 - 16 LIST OF HAZARDOUS SUBSTANCES	
2	Error Codes	Explain about error codes and procedures for reset according to instruction manual.	9. TROUBLESHOOTING P.30-32 -10. SERVICE & REPAIR	
3	Maintenance and inspection	Explain about maintenance of equipment and each component according to instruction manual	6. HANDLING PRECAUTIONS P.25-28 7. MAINTENANCE PROCEDURES	
4	Completion of installation  Matters to be stated	- Enter the date of installation and name of the charged personnel in the main unit nameplate. - Write necessary information on warranty card and hand it over to customer - Explain how to contact with service personnel	10. SERVICE & REPAIR P.32	

## Limited Liability

**Always operate equipment in strict compliance to the handling and operation procedures set forth by this instruction manual.**

**Yamato Scientific Co., Ltd. assumes no responsibility for malfunction, damage, injury or death, resulting from negligent equipment use.**

**Never attempt to disassemble, repair or perform any procedure on CF302L-A Neocool® Circulator which are not expressly mandated by this manual. Doing so may result in equipment malfunction, serious personal injury or death.**

## Notice

- **Instruction manual descriptions and specifications are subject to change without notice.**
- **Yamato Scientific Co., Ltd. will replace flawed instruction manuals (pages missing, pages out of order, etc.) upon request.**

Instruction Manual  
Neocool® circulator  
model CF302L-A

First Edition: May 29, 2019

Revised: July 11, 2019

---

### **Manufacturer**

**Yamato Scientific Co., Ltd.  
Harumi Triton Square Office Tower Y (36F)  
1-8-11 Harumi, Chuo-ku, Tokyo 104-6136, JAPAN**

**Yamato Scientific America Inc.  
925 Walsh Avenue, Santa Clara,  
CA 95050, U.S.A**

**<http://www.yamato-usa.com>  
Toll Free: 1-800-2-YAMATO (1-800-292-6286)**