

INSTALLATION INSTRUCTIONS

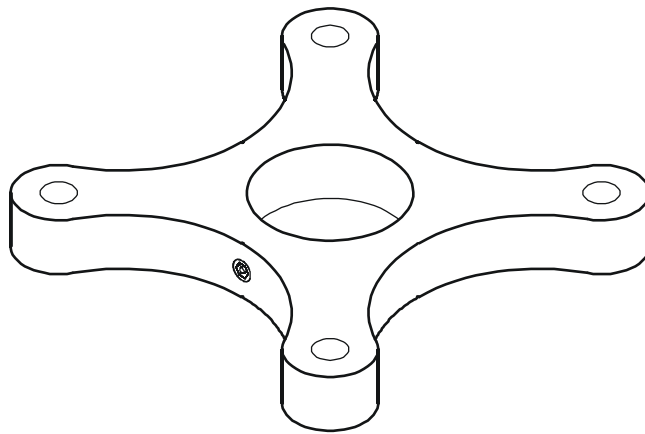

Ceiling Plate

DISCLAIMER

Milestone AV Technologies and its affiliated corporations and subsidiaries (collectively "Milestone"), intend to make this manual accurate and complete. However, Milestone makes no claim that the information contained herein covers all details, conditions or variations, nor does it provide for every possible contingency in connection with the installation or use of this product. The information contained in this document is subject to change without notice or obligation of any kind. Milestone makes no representation of warranty, expressed or implied, regarding the information contained herein. Milestone assumes no responsibility for accuracy, completeness or sufficiency of the information contained in this document.

Chief® is a registered trademark of Milestone AV Technologies. All rights reserved.



IMPORTANT SAFETY INSTRUCTIONS!



WARNING: A WARNING alerts you to the possibility of serious injury or death if you do not follow the instructions.



CAUTION: A CAUTION alerts you to the possibility of damage or destruction of equipment if you do not follow the corresponding instructions.



WARNING: Failure to read, thoroughly understand, and follow all instructions can result in serious personal injury, damage to equipment, or voiding of factory warranty! It is the installer's responsibility to make sure all components are properly assembled and installed using the instructions provided.



WARNING: Failure to provide adequate structural strength for this component can result in serious personal injury or damage to equipment! It is the installer's responsibility to make sure the structure to which this component is attached can support five times the combined weight of all equipment. Reinforce the structure as required before installing the component.



WARNING: Exceeding the weight capacity can result in serious personal injury or damage to equipment! It is the installer's responsibility to make sure the combined weight of all components attached to the CMA101 mount does not exceed 500 lbs (226.8 kg).

NOTE: The weight capacity of the CMA101 mount may be LIMITED to the lowest weight capacity of any other component located within the mounting system.



WARNING: Use this mounting system only for its intended use as described in these instructions. Do not use attachments not recommended by the manufacturer.



WARNING: Never operate this mounting system if it is damaged. Return the mounting system to a service center for examination and repair.



WARNING: Do not use this product outdoors.



WARNING: Do NOT attach to vertical mounting surfaces such as walls or angled ceilings!

IMPORTANT ! : The CMA101 mount is designed to be:

- mounted to double 2" x 4" wood stud cross bracing between two 2" x 4" ceiling joists using 5/16" x 3-1/2" Grade 2 lag bolts (not included); or
- mounted to a concrete ceiling with a minimum thickness of 8" and a maximum drywall covering of 5/8" using 5/16" x 3-1/2" Grade 2 lag bolts (not included) with UX10 **OR** AF8 anchors (not included); or
- suspended from four 5/16-18 Grade ASTM A307 or better threaded rods (not included) which are secured to Unistrut® (with a maximum span of 48") by 5/16" Grade 2 or better nuts (not included). Threaded rods must have 18 threads per square inch.

--SAVE THESE INSTRUCTIONS--

TOOLS REQUIRED FOR INSTALLATION

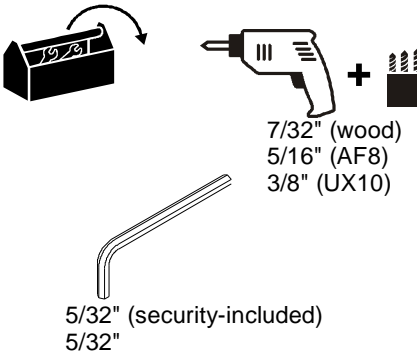

7/32" (wood)
5/16" (AF8)
3/8" (UX10)

5/32" (security-included)
5/32"



Hardware required - not included
(dependent on installation method)

- 1. Install to wood ceiling joists**
 - 5/16" x 3-1/2" (minimum length) Grade 2 lag bolts (Qty. 4)
- 2. Install to concrete**
 - 5/16" x 3-1/2" (minimum length) Grade 2 lag bolts (Qty. 4)
 - Fischer UX10 concrete anchors **OR** Toggler AF8 concrete anchors (Qty. 4)
- 3. Install to Unistrut**
 - 5/16-18 threaded rod (Qty. 4)
 - 5/16" Grade 2 nuts (Qty. 8)
 - 5/16" Grade 2 washers (Qty. 8)

PARTS



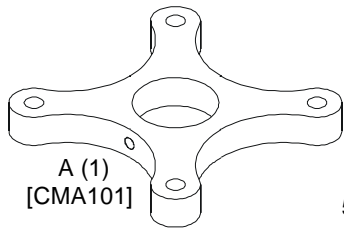

A (1)
[CMA101]

B (1)
5/16-18 x 3/8"



C (1)
5/16-18 x 5/16"
(security)



D (1)
5/32" (security)

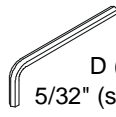

DIMENSIONS

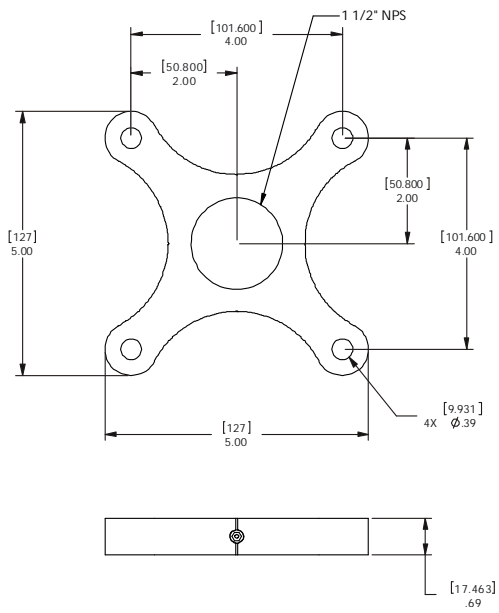

1 1/2" NPS

[101.600] 4.00

[50.800] 2.00

[127] 5.00

[50.800] 2.00

[101.600] 4.00

[127] 5.00





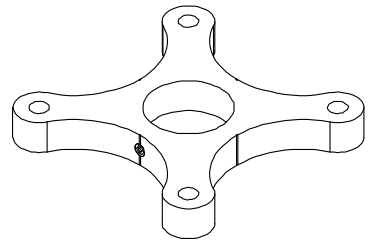





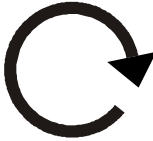

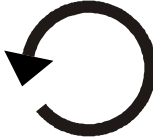
[9.931] 4X Ø.39

[17.463] .69



DIMENSIONS: [MILLIMETERS]
INCHES

LEGEND

	Tighten Fastener Apretar elemento de fijación Befestigungsteil festziehen Apertar fixador Serrare il fissaggio Bevestiging vastdraaien Serrez les fixations		Pencil Mark Marcar con lápiz Stiftmarkierung Marcar com lápis Segno a matita Potloodmerkteken Marquage au crayon
	Loosen Fastener Aflojar elemento de fijación Befestigungsteil lösen Desapertar fixador Allentare il fissaggio Bevestiging losdraaien Desserrez les fixations		Drill Hole Perforar Bohrloch Fazer furo Praticare un foro Gat boren Percez un trou
	Phillips Screwdriver Destornillador Phillips Kreuzschlitzschraubendreher Chave de fendas Phillips Cacciavite a stella Kruiskopschroevendraaier Tournevis à pointe cruciforme		Adjust Ajustar Einstellen Ajustar Regolare Afstellen Ajuster
	Open-Ended Wrench Llave de boca Gabelschlüssel Chave de bocas Chiave a punte aperte Steeksleutel Clé à fourche		Remove Quitar Entfernen Remover Rimuovere Verwijderen Retirez
	By Hand A mano Von Hand Com a mão A mano Met de hand À la main		Optional Opcional Optional Opcional Opzionale Optie En option
	Hex-Head Wrench Llave de cabeza hexagonal Sechskantschlüssel Chave de cabeça sextavada Chiave esagonale Zeskantsleutel Clé à tête hexagonale		Security Wrench Llave de seguridad Sicherheitsschlüssel Chave de segurança Chiave di sicurezza Veiligheidsleutel Clé de sécurité

INSTALLATION



WARNING: Do NOT attach to vertical mounting surfaces such as walls or angled ceilings!



WARNING: IMPROPER INSTALLATION CAN LEAD TO MOUNT FALLING CAUSING SEVERE PERSONAL INJURY OR DAMAGE TO EQUIPMENT! It is the installer's responsibility to make certain the structure to which the mount is being attached is capable of supporting five times the weight of the CMA mount and all attached equipment. Reinforce the structure as required before installing the mount.

NOTE: The following instructions assume a suitable mounting structure and surface exists prior to installation.

NOTE: Proceed to **Wood Stud Installation** section, **Solid Concrete Installation** section, or **Threaded Rod Installation** section.

Wood Stud Installation

1. Carefully determine required mounting location.

IMPORTANT ! : This will require knowing the lens to screen distance. See projector specifications for details on determining this distance.



WARNING: IMPROPER INSTALLATION CAN RESULT IN SERIOUS PERSONAL INJURY OR DAMAGE TO EQUIPMENT! Structural members **MUST** be capable of supporting five times the combined weight of all equipment being mounted.

IMPORTANT ! : The CMA101 is designed to be mounted to double 2" x 4" wood stud cross bracing (4" on center) between two ceiling joists with a maximum drywall covering of 5/8".

2. Using the CMA101 as a guide, mark four mounting hole locations. Hole locations must be centered on 2" x 4" cross braces. (See Figure 1)

3. Drill four 7/32" diameter x 2-1/2" long pilot holes. (See Figure 1)

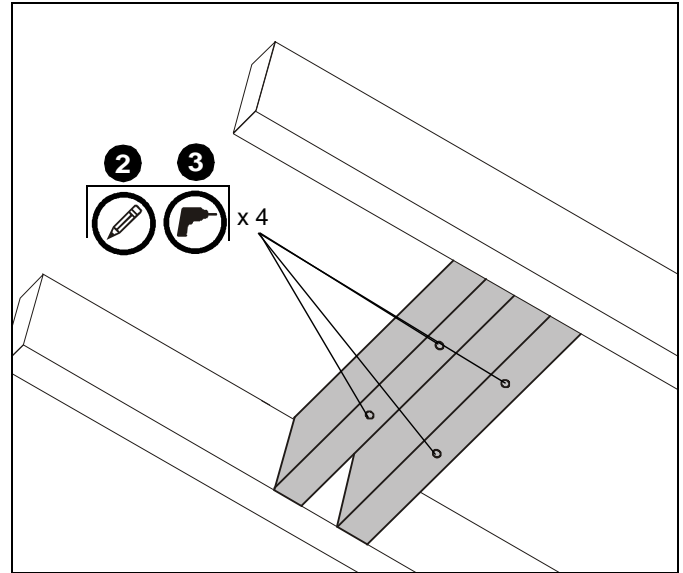

Figure 1

4. Align four mounting holes in CMA101 with four pilot holes. (See Figure 2)
5. Secure CMA101 to structure using four 5/16" x 3-1/2" Grade 2 lag bolts (not included). (See Figure 2)

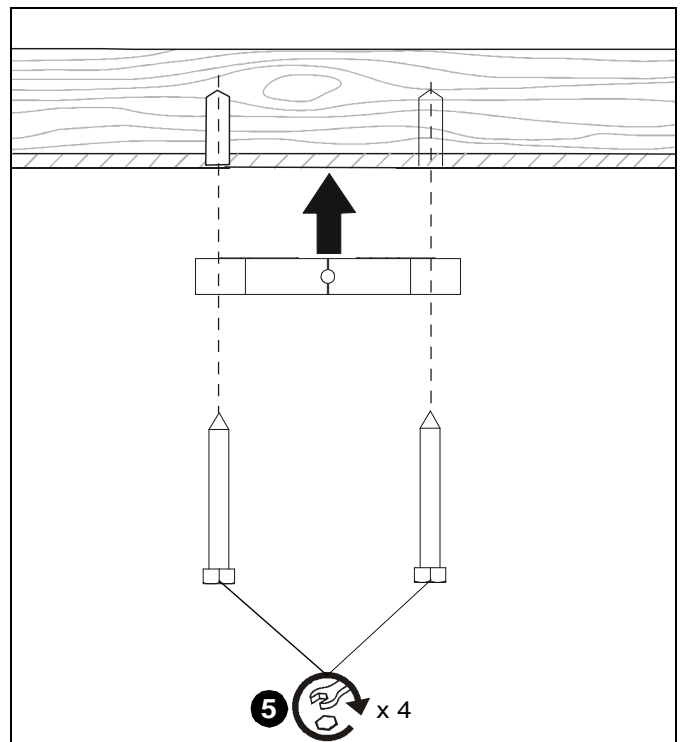

Figure 2

Solid Concrete Installation

1. Determine mounting location.

IMPORTANT ! : This will require knowing the lens to screen distance. See projector specifications for details on determining this distance.



WARNING: The CMA101 is designed to be mounted to a concrete ceiling with a minimum thickness of 8" and a maximum drywall covering of 5/8".



WARNING: IMPROPER INSTALLATION CAN RESULT IN SERIOUS PERSONAL INJURY OR DAMAGE TO EQUIPMENT! Structural members **MUST** be capable of supporting five times the combined weight of all equipment being mounted.

2. Using the CMA101 as a guide, mark four mounting hole locations on ceiling. (See Figure 3)
3. Drill four 3-1/4" deep pilot holes. (See Figure 3)
 - For Fischer UX10 anchors, use a 3/8" drill bit.
 - For Toggler AF8 anchors, use a 5/16" drill bit.
4. Align four mounting holes in CMA101 with four pilot holes.

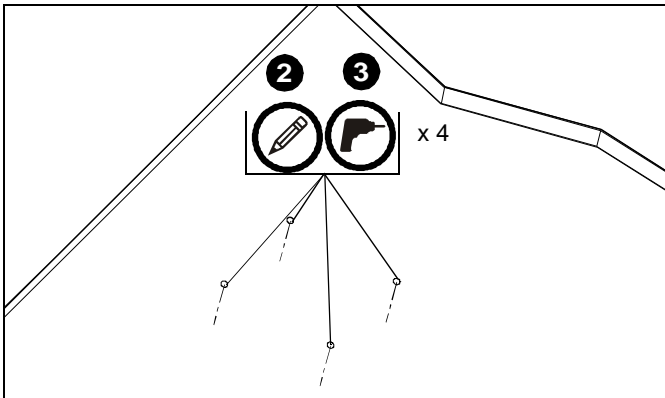

Figure 3



WARNING: Anchors (not provided) must be installed into structurally sound solid concrete. Installation into hollow concrete block, mortar, or concrete that exhibits cracking, spalling, or other defects may result in failure of anchor and serious personal injury or damage to equipment.

5. Install four Fischer UX10 or Toggler AF8 concrete anchors (not included) until flush with mounting surface. (See Figure 4)
6. Secure CMA101 to structure using four 5/16" x 3-1/2" Grade 2 lag bolts (not included). (See Figure 4)

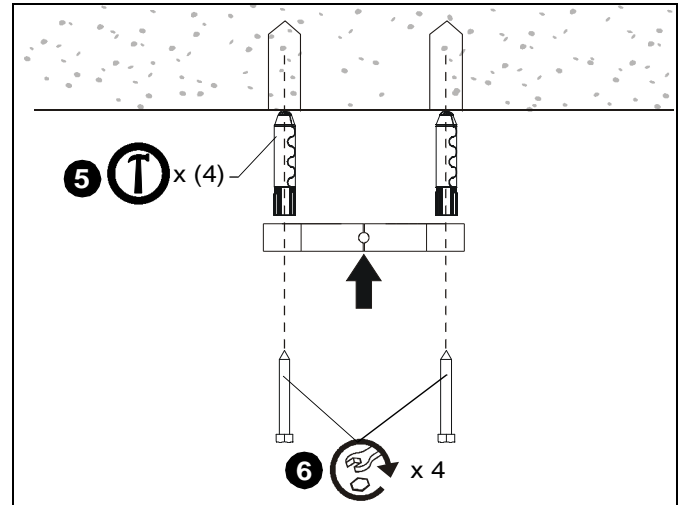

Figure 4

Threaded Rod Installation

IMPORTANT ! : The CMA101 ceiling plate may be installed via threaded rods to 1-5/8" wide Unistrut ceiling channels spanning a maximum distance of 48". The total combined weight of all components attached to the CMA101 **MUST NOT** exceed the allowable load of the channel!

NOTE: The CMA101 may be suspended from four 5/16-18 Grade ASTM A307 or better threaded rods (not included) which are secured to Unistrut by 5/16" Grade 2 or better nuts (not included). Threaded rods must have 18 threads per square inch.

1. Secure one end of each of the four threaded rods (not included) to the structural member.
2. Install one 5/16" nut (not included) and one 5/16" washer (not included) onto each threaded rod.
3. Install CMA101 onto threaded rods, inserting the rods into the four holes on top of the CMA101.
4. Secure the threaded rods to the CMA101 with one 5/16" nut (not included) and one 5/16" washer (not included) on each threaded rod. (See Figure 5)

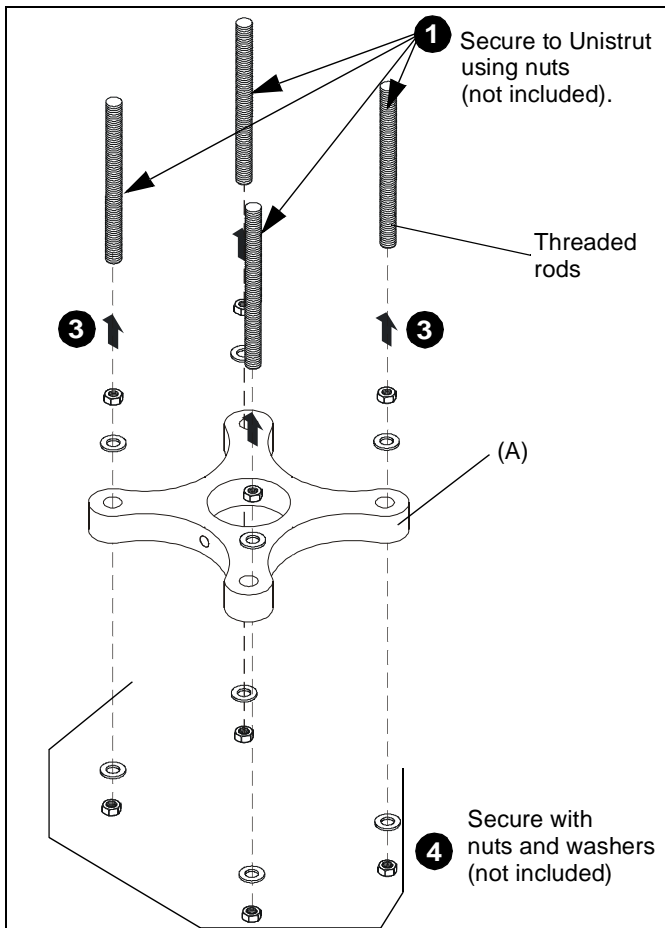

Figure 5

Attaching Column to CMA101

1. Install 1-1/2" NPT or NPSM following ANSI/ASME B1.20.1 (Schedule 40, 0.154" minimum thickness steel or aluminum - ASTM B221) threaded extension column (not included) into threaded collar of CMA101 until tight, with a minimum of four threads engaged. (See Figure 6)
2. Install 5/16-18 x 3/8" set screw (B) [**OPTIONAL:** Use one 5/16-18 x 5/16" security set screw (C) for security installation] into hole on ceiling plate (A) to secure pipe to mount. (See Figure 6)

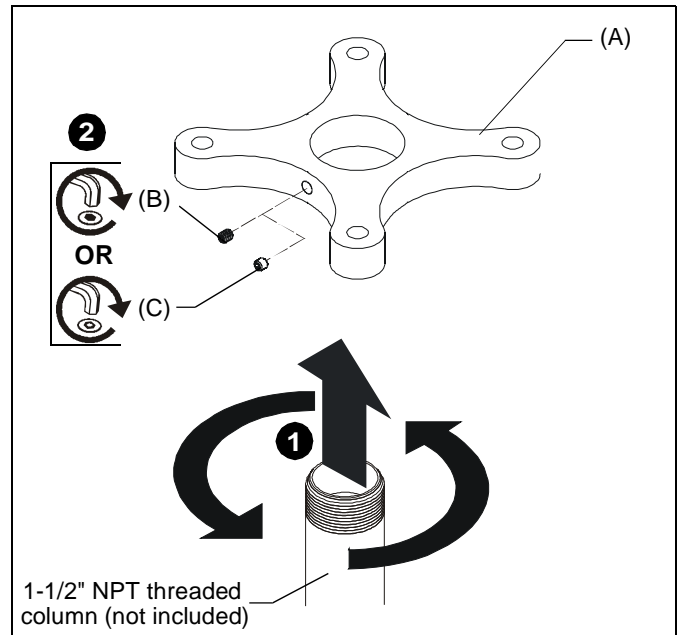

Figure 6



Our Mounts. **Your Vision.**

Chief, a products division of
Milestone AV Technologies

8800-002519 Rev00
©2014 Milestone AV Technologies
www.chiefmfg.com
03/14

USA/International	A 6436 City West Parkway, Eden Prairie, MN 55344 P 800.582.6480 / 952.225.6000 F 877.894.6918 / 952.894.6918
Europe	A Franklinstraat 14, 6003 DK Weert, Netherlands P +31 (0) 495 580 852 F +31 (0) 495 580 845
Asia Pacific	A Office No. 1 on 12/F, Shatin Galleria 18-24 Shan Mei Street Fotan, Shatin, Hong Kong P 852 2145 4099 F 852 2145 4477

