

# MaxQ 2000 CO2 Plus

## Digital CO2 Resistant Shaker

Catalog #88881101, #88881102

Operation Manual 0000847

Visit us online to register your warranty  
[www.thermoscientific.com/labwarranty](http://www.thermoscientific.com/labwarranty)

**Thermo**  
SCIENTIFIC

**MANUAL NUMBER 0000-847**

---

|            |                |             |                    |           |
|------------|----------------|-------------|--------------------|-----------|
| 0          | --             | 06/06/2017  | Original           |           |
| <b>REV</b> | <b>ECR/ECN</b> | <b>DATE</b> | <b>DESCRIPTION</b> | <b>By</b> |

---

## Do You Need Information or Assistance on Thermo Scientific Products?

If you do, please contact us 8:00 a.m. to 6:00 p.m. (Eastern Time) at:

1-740-373-4763

1-800-438-4851

1-877-213-8051

<http://www.thermoscientific.com>

[service.led.marietta@thermofisher.com](mailto:service.led.marietta@thermofisher.com)

[www.unitylabservices.com](http://www.unitylabservices.com)

Direct

Toll Free, U.S. and Canada

FAX

Internet Worldwide Web Home Page

Tech Support Email Address

Certified Service Web Page

Our **Sales Support** staff can provide information on pricing and give you quotations. We can take your order and provide delivery information on major equipment items or make arrangements to have your local sales representative contact you. Our products are listed on the Internet and we can be contacted through our Internet home page.

Our **Service Support** staff can supply technical information about proper setup, operation or troubleshooting of your equipment. We can fill your needs for spare or replacement parts or provide you with on-site service. We can also provide you with a quotation on our Extended Warranty for your Thermo Scientific products.

Whatever Thermo Scientific products you need or use, we will be happy to discuss your applications. If you are experiencing technical problems, working together, we will help you locate the problem and, chances are, correct it yourself...over the telephone without a service call.

When more extensive service is necessary, we will assist you with direct factory trained technicians or a qualified service organization for on-the-spot repair. If your service need is covered by the warranty, we will arrange for the unit to be repaired at our expense and to your satisfaction.

Regardless of your needs, our professional telephone technicians are available to assist you Monday through Friday from 8:00 a.m. to 6:00 p.m. Eastern Time. Please contact us by telephone or fax.

International customers, please contact your local Thermo Scientific distributor.

# Table of Contents







|                  |  |            |
|------------------|--|------------|
| <b>Section 1</b> | <b>Unpacking and Installation</b> .....          | <b>1-1</b> |
|                  | Universal (Aluminum) Platform Installation ..... | 1-3        |
|                  | Rubber Mat Platform Installation .....           | 1-4        |
|                  | Connections of the Instrument .....              | 1-5        |
| <b>Section 2</b> | <b>Overview</b> .....                            | <b>2-1</b> |
|                  | Specifications .....                             | 2-1        |
|                  | Safety Tips .....                                | 2-2        |
|                  | Storing the Signal Cable .....                   | 2-2        |
|                  | Maximum Shaking Speed .....                      | 2-3        |
| <b>Section 3</b> | <b>Operation</b> .....                           | <b>3-1</b> |
|                  | Operations on the Control Panel .....            | 3-1        |
|                  | Speed and Time Settings .....                    | 3-2        |
|                  | Alarm System .....                               | 3-3        |
| <b>Section 4</b> | <b>Application</b> .....                         | <b>4-1</b> |
| <b>Section 5</b> | <b>Safety Tips and Maintenance</b> .....         | <b>5-1</b> |
| <b>Section 6</b> | <b>Optional Accessories</b> .....                | <b>6-1</b> |
| <b>Section 7</b> | <b>Troubleshooting</b> .....                     | <b>7-1</b> |
| <b>Section 8</b> | <b>Warranty Information</b> .....                | <b>8-1</b> |



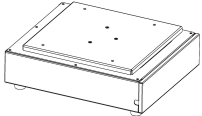

## Section 1 Unpacking and Installation

1. Inspect contents upon receipt of the instrument, if the instrument is upside down, contact the manufacturer immediately.
2. Check packing list below. If there are any damaged or missing items, contact the manufacturer.
3. Place the instrument on a level and firm surface, to avoid vibration and noise.

**Table 1-1.** Packing List

| Thermo Scientific Cat. No.     | 88881101                            | 88881102                                  | 88881103   | 88881104   | Picture   |
|--------------------------------|-------------------------------------|---|--|--|---|
| Model name on carton box label | MaxQ2000C02 Plus, 100-240V, for USA | MaxQ2000C02 Plus, 100-240V, various plugs | MaxQ2000C02 Plus Promotion Package for USA, includes CO2 resistant shaker (88881101), Universal Platform and Flask Clamp Starter Kit | MaxQ2000C02 Plus Promotion Package for EMEA & APAC, includes CO2 resistant shaker (88881102), Universal Platform & Flask Clamp Starter Kit |   |
| Main Body                      | 1                                   | 1   | 1  | 1  |  |
| Control Box                    | 1                                   | 1   | 1  | 1  |  |
| General Power Adaptor          | 1                                   | 1   | 1  | 1  |  |
| US Plug                        | 1                                   | N/A                                       | 1  | N/A  |  |
| CN Plug                        | N/A                                 | 1   | N/A  | 1  |  |
| EU Plug                        | N/A                                 | 1   | N/A  | 1  |  |

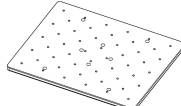
**Table 1-1.** Packing List (continued)

| Thermo Scientific Cat. No.            | 88881101                                   | 88881102   | 88881103  | 88881104  | Picture   |
|---------------------------------------|--|--|---|---|---|
| <b>Model name on carton box label</b> | <b>MaxQ2000C02 Plus, 100-240V, for USA</b> | <b>MaxQ2000C02 Plus, 100-240V, various plugs</b> | <b>MaxQ2000C02 Plus Promotion Package for USA, includes CO2 resistant shaker (88881101), Universal Platform and Flask Clamp Starter Kit</b> | <b>MaxQ2000C02 Plus Promotion Package for EMEA &amp; APAC, includes CO2 resistant shaker (88881102), Universal Platform &amp; Flask Clamp Starter Kit</b> |   |
| UK Plug                               | N/A  | 1  | N/A   | 1   |    |
| Universal Platform (AL)               | N/A  | N/A  | 1   | 1   |    |
| 100ml Flask Clamp                     | N/A  | N/A  | 2   | 2   |  |
| 250ml Flask Clamps                    | N/A  | N/A  | 4   | 4   |   |
| 500ml Flask Clamps                    | N/A  | N/A  | 4   | 4   |   |
| 1L Flask Clamps                       | N/A  | N/A  | 2   | 2   |  |
| 2L Flask Clamps                       | N/A  | N/A  | 2   | 2   |   |

## Universal (Aluminum) Platform Installation

1. Place the instrument on a level and firm surface; it must be capable of supporting the weight and load of the instrument, and the impact force generated by the motion. Prepare related parts (see Figure 1-1).

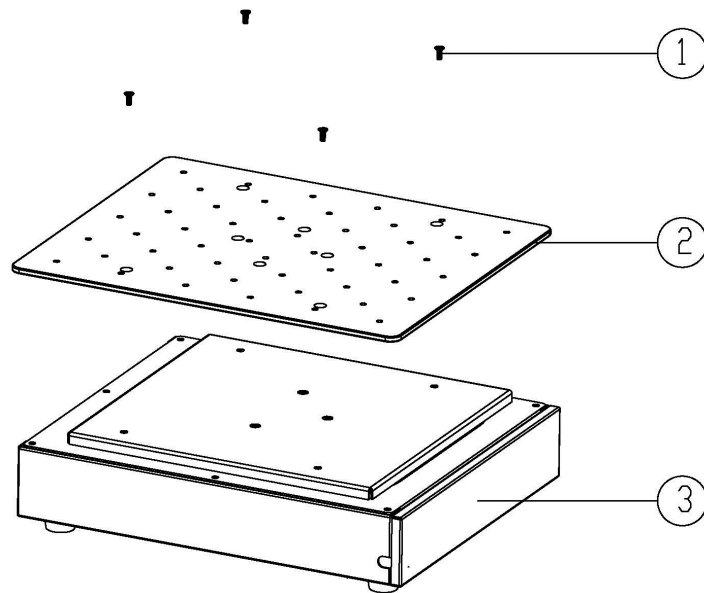

- 1) M4x10 cross recessed countersink head screws
- 2) Universal (aluminum) platform
- 3) Main body of CO<sub>2</sub> resistant shaker

**Figure 1-1.** Universal Platform Installation Diagram

2. Install the horizontal universal platform on the fixed plate of the Main body, ensure all four mounting holes in the universal platform and the four threaded mounting holes are in alignment
3. Fasten the universal platform and the fixed plate with four M4x10 cross recessed countersink head screws.



## Rubber Mat Platform Installation

1. Place the instrument on a level and firm surface; it must be capable of supporting the weight and load of the instrument and the impact force generated by the motion. Prepare related parts (see Figure 1-2).

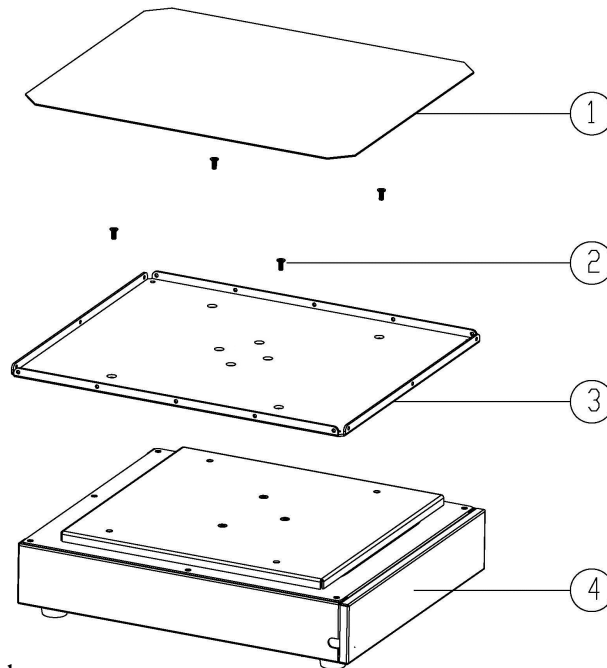

- 1) Rubber mat
- 2) M4x10 cross recessed countersunk head screws
- 3) Platform
- 4) Main body of CO2 resistant shaker

**Figure 1-2.** Rubber Mat Platform Installation Diagram

2. Install the horizontal platform on the fixed plate of the Main body; ensure all four mounting holes on the platform and the four threaded mounting holes are in alignment.
3. Fasten the platform and the fixed plate with four M4x10 cross recessed countersink head screws.
4. Place the rubber mat on the platform.

## Connections of the Instrument

Refer to Figure 1-3 when connecting the instrument.

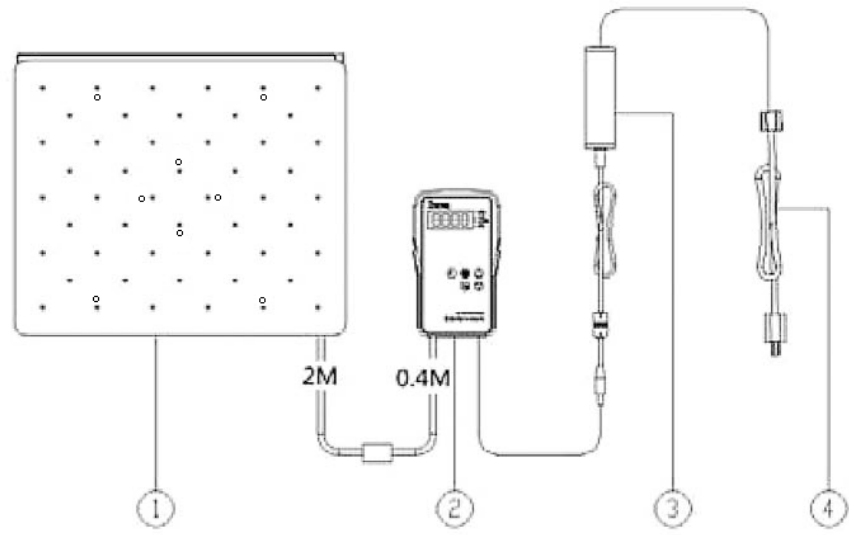

- 1) Main body of CO2 resistant shaker
- 2) Control box
- 3) Power adapter
- 4) Power cord

**Figure 1-3.** Circuit Diagram



## Section 2 Overview

### Specifications

#### Speed

|                  |            |
|------------------|------------|
| Speed Range      | 30-300 RPM |
| Speed Accuracy   | ±1 RPM     |
| Motion Type      | Orbital    |
| Orbit Diameter   | Ø19mm      |
| Display          | LED        |
| Display Accuracy | 1 RPM      |
| Maximum Load     | .6 kg      |

#### Timer

|                |              |
|----------------|--------------|
| Timer Range    | 0~99h 59min. |
| Hour Display   | LED          |
| Minute Display | LED          |

#### Dimensions (WxDxH)

|             |   |
|-------------|---|
| Main body   | 360 x 300 x 96mm (14.2 x 11.8 x 3.8 inch) |
| Control Box | 95 x 158 x 26mm (3.7 x 6.2 x 1.0 inch)    |

#### Weight

|              |                     |
|--------------|---------------------|
| Main body    |                     |
| Net Weight   | 17.5 kg (38.58 lbs) |
| Control Box  |                     |
| Net Weight   | 0.3 kg (0.66 lbs)   |
| Gross weight | 19 kg (41.9 lbs)    |

#### Ambient

|                               |             |
|-------------------------------|-------------|
| Altitude                      | <2,000 m    |
| Temperature                   | 4°C to 60°C |
| Relative Humidity             | 20% to 99%  |
| CO <sub>2</sub> Concentration | 0% to 20%   |

#### Storage Conditions

|                   |             |
|-------------------|-------------|
| Altitude          | <2,000m     |
| Temperature       | 5°C to 60°C |
| Relative Humidity | 20% to 90%  |

#### Other

|               |                             |
|---------------|-----------------------------|
| Noise level   | <60dB                       |
| Certification | RoHS, WEEE, cCSAus, CE Mark |
| Power supply  | 100-240VAC, 50Hz/60Hz       |

## Safety Tips

1. Unplug and unload before moving the unit.
2. This instrument uses a single-phase AC100-240V 50/60Hz power supply.
3. Remove the power supply when the instrument is in maintenance.
4. DO NOT clean the unit with flammable or corrosive liquid.
5. Use specified power supply.
6. Maximum load 6kg, 13.23 lbs.
7. To ensure proper operation, the unit must be free of surrounding obstructions.

## Storing the Signal Cable

To store the signal cable, simply open the side plate on the main body. Refer to Figure 2-1. The signal cable can be placed inside.

**Caution** When storing the cable, pay attention to closing the side plate door, to avoid pinching your fingers. ▲

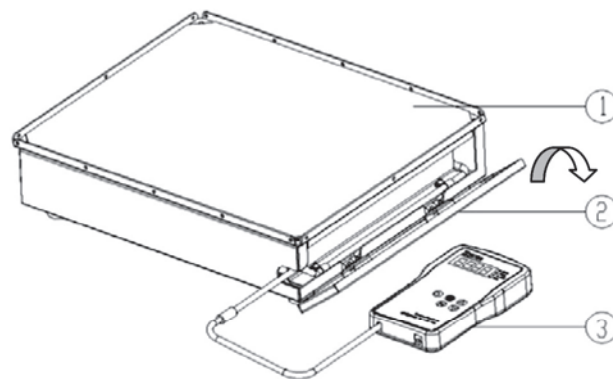

- 1) Main body of CO2 resistant shaker
- 2) Side plate
- 3) Control box

**Figure 2-1.** Storing the Signal Cable Diagram

## Maximum Shaking Speed

**Table 2-1.** Maximum Shaking Speed on Rubber Platform in Relation to Flask Size

| Flask Size | Running speed |          |
|------------|---------------|----------|
|            | 0-150rpm      | 0-200rpm |
| 50ml       |               | √        |
| 100ml      |               | √        |
| 150ml      |               | √        |
| 200ml      |               | √        |
| 250ml      |               | √        |
| 500ml      |               | √        |
| 1000ml     | √             | —        |
| 2000ml     | √             | —        |
| 3000ml     | √             | —        |
| 5000ml     | √             | —        |

**Table 2-2.** Maximum Shaking Speed and Flask Capacity on Universal Platform

| Flask clamp |               | Maximum Flask Capacity | Running speed (rpm) |       |
|-------------|---------------|------------------------|---------------------|-------|
| Size        | Liquid volume |                        | 0-200               | 0-300 |
| 50ml        | ≤50ml         | 30                     |                     | √     |
| 100ml       | ≤100ml        | 15                     |                     | √     |
| 150ml       | ≤150ml        | 15                     |                     | √     |
| 200ml       | ≤200ml        | 15                     |                     | √     |
| 250ml       | ≤250ml        | 15                     |                     | √     |
| 500ml       | ≤500ml        | 9                      |                     | √     |
| 1000ml      | ≤500ml        | 6                      |                     | √     |
|             | ≤1000ml       | 6                      | √                   | —     |
| 2000ml      | ≤1000ml       | 4                      |                     | √     |
|             | ≤2000ml       | 2                      | √                   | —     |
| 3000ml      | ≤1500ml       | 2                      |                     | √     |
|             | ≤3000ml       | 2                      | √                   | —     |
| 5000ml      | ≤2500ml       | 1                      | √                   | —     |
|             | ≤5000ml       | 1                      | √                   | —     |

**Note** The flask clamps (≤2L) can be placed anywhere on the universal (aluminum) platform, even if the load is not balanced. ▲



## Section 3 Operation

The unit has been designed with a “soft start/slowdown” providing a smooth acceleration/deceleration during operation. This feature will decrease splashing of solutions from vessels during operation.

**Warning** The microprocessor control system may take 1 minute to synchronize the actual RPM of the universal (aluminum) platform to the desired RPM setting. Make sure that all the flasks and test tubes are firmly fixed on the universal platform and the flask clamps are fasten securely with the screws. ▲

### Operations on the Control Panel

4 digit LEDs, 4 indicator lights and 5 buttons.

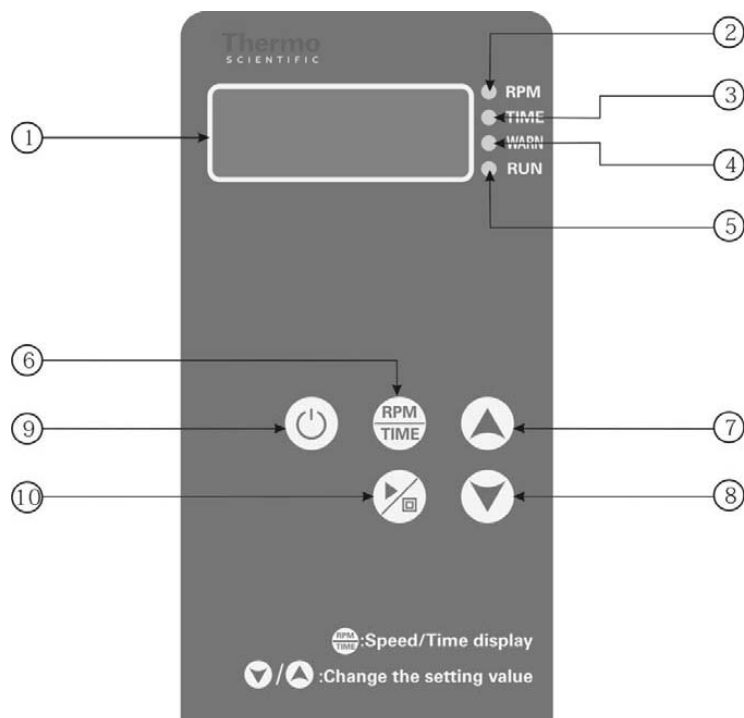

- 1) Display LED: Shows time or speed
- 2) RPM indicator light: LED shows current speed
- 3) TIME indicator light: LED shows current time.
- 4) WARN indicator light: Over-speed alarm.
- 5) RUN indicator light: The instrument is running.
- 6) RPM/TIME Key: While instrument is in operation, press to change time and speed display; when setting parameter, press to change minutes, hour or speed.

- 7) Up Arrow Key: Increases value. Hold for 3 seconds to increase rapidly.
- 8) Down Arrow Key: Decreases value. Hold for 3 seconds to decrease rapidly.
- 9) Power Key: The power is On/Off.
- 10) Square Key: The instrument is running or stopped.



## Speed and Time Settings

### Speed setting

1. Press RPM/TIME key. The speed indicator light is lit.
2. Press up and down arrow keys to access the speed setting state, speed value starts flashing.
3. Press up and down arrow keys to change the speed value. Speed increases or decreases. The minimum unit is 1rpm.
4. During settings, the unit will reset to current values if no value is input after three seconds.
5. Press  key to run or stop.

### Time setting

1. Press RPM/TIME key. The time indicator light is lit.
2. Press up and down arrow keys to access the time setting state. Speed value starts flashing;
3. Press up and down arrow keys to change the time value. Time increases or decreases. The minimum unit is 1 minute or 1 hour.
4. During settings, the unit will reset to current values if no value is input after three seconds.
5. Press  key to run or stop.

### Notes

1. When the shaker is running, the LED display will switch between the speed and timer function every 30 seconds automatically. Press RPM/TIME key to manually toggle between the speed and timer value.
2. In “timer mode” the LED display will show the remaining running time.
3. In “continuous mode” the LED display will show elapsed run time.
4. After the run is complete, the LED display will read “end”. Press any key to place the shaker in standby mode.

## **Alarm System**    Alarm System

1. During operation, the alarm will sound after 10 seconds if the unit has not begun shaking. In addition, the alarm will sound and stop for the speed over 350 rpm after 2 seconds.
2. Once the shaker begins to alarm, the RUN indicator light will not be visible and the WARN indicator light will flash, and the unit will stop running.

### **Power failure recovery**

When the power supply is cut off suddenly to the shaker, resulting in a power failure, the unit will automatically run at the previous set parameter upon power restoration.



## Section 4 Application

### Application on Lab Benches

To operate the shaker outside of a CO<sub>2</sub> incubator, refer to Specifications in Section 2.

### Application in CO<sub>2</sub> Incubator

Place the main body of the shaker in the CO<sub>2</sub> incubator, and use the signal cable to connect the control box through the access port of the CO<sub>2</sub> incubator. Refer to Figure 4-1.

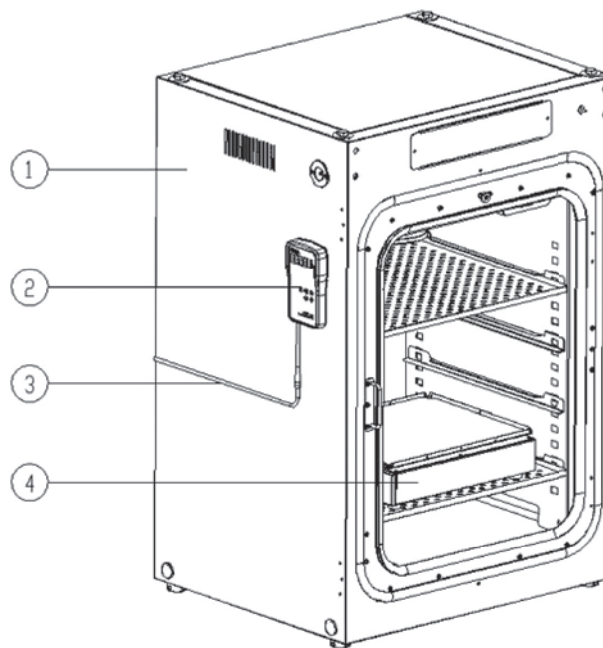

- 1) CO<sub>2</sub> Incubator
- 2) Control Box
- 3) Power Cord
- 4) Main body of CO<sub>2</sub> Resistant Shaker

**Figure 4-1.** Application in CO<sub>2</sub> incubator

**Warning**

1. Never put the control box in the CO<sub>2</sub> incubator.
2. The back of control box is magnetized, and can be attached on the surface of the CO<sub>2</sub> incubator.
3. When the main body of CO<sub>2</sub> Resistant Shaker is in operation in the CO<sub>2</sub> incubator, keep a safe distance from the inner wall of the CO<sub>2</sub> incubator to avoid collisions.
4. The main body of the shaker should be connected to the control box wire through the access port of the CO<sub>2</sub> incubator.
5. If the cells are sensitive to vibrations, do not put them in the same incubator or on the shaker.

## Section 5 **Safety Tips and Maintenance**

### Safety Tips

1. Confirm local power supply voltage before use the unit.
2. The unit must not be plugged into a power supply extension with other pieces of equipment.
3. The data cable between the main body and control box cannot be extended.
4. Never modify the supplied power cables.
5. Service should only be performed by a qualified professional
6. In the following situations, the power supply must be unplugged:
  - When the unit is moved;
  - When the control box is opened
  - When a fuse is replaced;
  - When the equipment is not functioning properly;
  - When the equipment is not in use.

### Maintenance

Surfaces can be cleaned with mild detergent and water. Liquid should not be allowed to enter inside the unit.

## Section 5

### Safety Tips and Maintenance





#### Clean spill

If accidental spillage of liquids or other materials occur on the platform, shut down the machine and clean up the liquids or other materials immediately.

**Note** If liquid has entered the unit, remove the platform and clean it. ▲

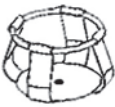

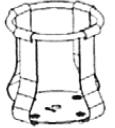

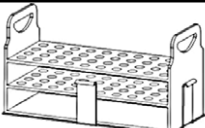

1. Turn off the machine and unplug the power cord.
2. Remove the platform (with 4 screws).
3. Remove top plate (with 7 screws).
4. Use 70% ETOH to clean the inner area.
5. All allow the unit to dry for one hour, reassemble unit, and operate normally.

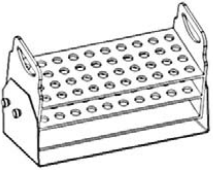
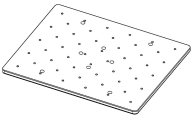
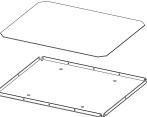

## Section 6 Optional Accessories

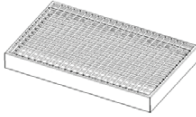
| Description                  | Cat. No. | Dimensions (WxDxH) mm | Number of screws | Figure  |
|------------------------------|----------|-----------------------|------------------|---|
| 50ml clamp                   | 88881105 | 60×60×40              | 1                |    |
| 100ml clamp                  | 88881106 | 65×65×45              | 1                |   |
| 150ml clamp                  | 88881107 | 80×80×50              | 1                |   |
| 200ml clamp                  | 88881108 | 80×80×55              | 1                |   |
| 250ml clamp                  | 88881109 | 90×90×60              | 1                |   |
| 500ml clamp                  | 88881110 | 115×115×70            | 1                |   |
| 1000ml clamp                 | 88881111 | 130×130×75            | 4                |  |
| 2000ml clamp                 | 88881112 | 170×170×100           | 4                |   |
| 3000ml clamp                 | 88881113 | 200×200×140           | 4                |   |
| 5000ml clamp                 | 88881114 | 245×245×140           | 4                |   |
| 500ml Infusion bottle clamp  | 88881115 | 100×100×95            | 4                |  |
| 1000ml Infusion bottle clamp | 88881116 | 125×125×125           | 4                |   |
| Funnel Clamp                 | 88881117 | N/A                   | 4                |  |
| Fixed Tube rack 40×Ø14mm     | 88881118 | 265×120×140           | 4                |  |
| Fixed Tube rack 40×Ø16mm     | 88881119 | 265×120×140           | 4                |   |



**Section 6**  
Optional Accessories

| Description                   | Cat. No. | Dimensions (WxDxH) mm | Number of screws | Figure  |
|-------------------------------|----------|-----------------------|------------------|---|
| Adjustable Tube rack 40xØ14mm | 88881120 | 285x125x175           | 4                |    |
| Adjustable Tube rack 40xØ16mm | 88881121 | 285x125x175           | 4                |   |
| Universal (Aluminum) platform | 88881122 | 360x300x5             | 4                |    |
| Rubber Mat platform           | 88881123 | 360x305x10            | 4                |    |
| 96-well microplate holder     | 88881124 | 130x90x15             | 4                |    |
| Spring Wire Rack              | 88881125 | 350X240X80            | 4                |   |
| Sticky Mat                    | 88881126 | 140x140               | N/A              |  |
| Control Box                   | 88881127 | 164x94x27             | N/A              |  |
| General Power Adaptor         | 88881128 | N/A                   | N/A              |  |
| US Plug                       | 88881129 | N/A                   | N/A              |  |

| Description             | Cat. No. | Dimensions<br>(WxDxH) mm | Number of screws | Figure   |
|-------------------------|----------|--------------------------|------------------|--|
| CN Plug                 | 88881130 | N/A                      | N/A              |                                     |
| EU Plug                 | 88881131 | N/A                      | N/A              |                                     |
| UK Plug                 | 88881132 | N/A                      | N/A              |                                     |
| Flask Clamp Starter Kit | 88881133 | N/A                      | N/A              | 100ml flask clamp x 2<br>250ml flask clamps x 4<br>500ml flask clamps x 4<br>1L flask clamps x 2<br>2L flask clamp x 2 |



## Section 7 Troubleshooting

To troubleshoot the unit, refer to the table below. If your problem persists, contact your local sales/service representative.

**Table 7-1.** Troubleshooting

| <b>Error</b>                 | <b>Cause</b>                               | <b>Solution</b>                             |
|------------------------------|--|---|
| Indicator off<br>No reaction | Power disconnected                         | Connect the power                           |
|                              | Power adapter failure                      | Replace power adapter                       |
|                              | Switched off                               | Switch on                                   |
| No rotating of platform      | Sensor failure                             | Contact local sales/service                 |
|                              | Main-board failure                         | Contact local sales/service                 |
| Loud noise                   | The unit has been placed on uneven surface | Place the unit on level and sturdy surface. |
|                              | Platform loose                             | Fasten platform                             |
|                              | Accessories loose                          | Fasten accessories                          |
| Other                        | Keep record for maintenance                |   |



## THERMO FISHER SCIENTIFIC STANDARD PRODUCT WARRANTY

The Warranty Period starts two weeks from the date your equipment is shipped from our facility. This allows for shipping time so the warranty will go into effect at approximately the same time your equipment is delivered. The warranty protection extends to any subsequent owner during the first year warranty period.

During the first two (2) years, component parts proven to be non-conforming in materials or workmanship will be repaired or replaced at Thermo's expense, labor included. Installation and calibration are not covered by this warranty agreement. The Technical Services Department must be contacted for warranty determination and direction prior to performance of any repairs. Expendable items, glass, filters and gaskets are excluded from this warranty.

Replacement or repair of components parts or equipment under this warranty shall not extend the warranty to either the equipment or to the component part beyond the original warranty period. The Technical Services Department must give prior approval for return of any components or equipment. At Thermo's option, all non-conforming parts must be returned to Thermo Fisher Scientific postage paid and replacement parts are shipped FOB destination.

**THIS WARRANTY IS EXCLUSIVE AND IN LIEU OF ALL OTHER WARRANTIES, WHETHER WRITTEN, ORAL OR IMPLIED. NO WARRANTIES OF MERCHANTABILITY OR FITNESS FOR A PARTICULAR PURPOSE SHALL APPLY.** Thermo shall not be liable for any indirect or consequential damages including, without limitation, damages relating to lost profits or loss of products.

Your local Thermo Sales Office is ready to help with comprehensive site preparation information before your equipment arrives. Printed instruction manuals carefully detail equipment installation, operation and preventive maintenance.

If equipment service is required, please call your Technical Services Department at 1-800-438-4851 (USA and Canada) or 1-740-373-4763. We're ready to answer your questions on equipment warranty, operation, maintenance, service and special application. Outside the USA, contact your local distributor for warranty information.

Rev. 0 9/13



**thermoscientific.com**

© 2014 Thermo Fisher Scientific Inc. All rights reserved. All trademarks are the property of Thermo Fisher Scientific and its subsidiaries. Specifications, terms and pricing are subject to change. Not all products are available in all countries. Please consult your local sales representative for details.

**Thermo**  
S C I E N T I F I C  
A Thermo Fisher Scientific Brand