

9mm Magnetic Connector, 4mm Straight Sheathed Banana Jack

CT3879-#

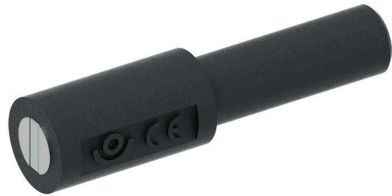

Features:

- Voltage Max - 30 Vac / 60 Vdc
- Current Max - 12 A
- Max Temperature - 80 °C (176 °F)
- Insulation Material - Polypropylene (PP)
- Magnet - N35 / 1.2 Tesla
- RoHS 2 Compliant

Measurement Drawing: (not to scale)

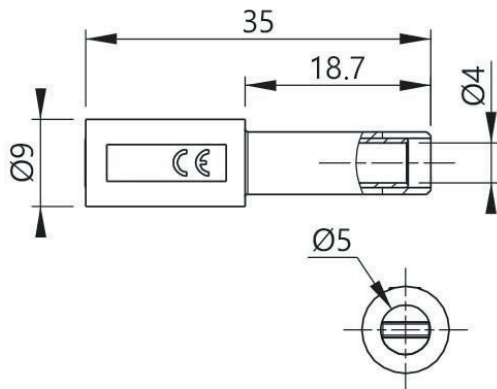

Description:

The 3800 series of Magnetic Connectors facilitates a quick and reliable way to connect to terminal block screws or any other ferromagnetic conductors. These connectors provide ample magnetic hold for hands-free operation.

Order Information:

CT3879-#

9mm Magnetic Connector, 4mm Straight Sheathed Banana Jack

- Color - replace '#' with dash number:
-0 Black, -2 Red, -4 Yellow, -5 Green, -6 Blue, -9 White

Contact Info:

Toll Free: 800-572-1028 (US Only)

Phone: 714-221-9330

Fax: 714-921-9849

22820 Savi Ranch Parkway

Yorba Linda, CA 92887-4610 USA

www.caltestelectronics.com



Copyright © 2019, Cal Test Electronics, Inc. All rights reserved. Information in this publication supersedes that in all previously published material. Trade names referenced are the service marks, trademarks or registered trademarks of their respective companies.