

DATA PROJECTOR

XJ-UT Series

XJ-UT312WN*/

XJ-UT352W/XJ-UT352WN*

XJ-F Series

XJ-F11X/XJ-F21XN*/

XJ-F101W/XJ-F211WN*

*Network Models

User's Guide

- In this manual, "XJ-UT Series" and "XJ-F Series" refer only to the specific models listed above.
- Be sure to read the "Safety Precautions" and "Operating Precautions" and make sure you use this product correctly.
- Keep this manual in a safe place for future reference.
- Visit the site below for the latest version of this manual.
<https://world.casio.com/manual/projector/>

- DLP is a registered trademark of Texas Instruments of the United States.
- Microsoft and Windows are registered trademarks or trademarks of Microsoft Corporation in the United States and other countries.
- HDMI, the HDMI Logo and High-Definition Multimedia Interface are trademarks or registered trademarks of HDMI Licensing Administrator, Inc.
- PJLink is a pending trademark or a registered trademark in Japan, the United States, and other countries and areas.
- Crestron and Crestron Connected are registered trademarks of Crestron Electronics, Inc. of the United States.
- Other company and product names may be registered trademarks or trademarks of their respective owners.
- Portions of this product are based in part on the work of the Independent JPEG Group.

- The contents of this User's Guide are subject to change without notice.
- Copying of this manual, either in part or its entirety is forbidden. You are allowed to use this manual for your own personal use. Any other use is forbidden without the permission of CASIO COMPUTER CO., LTD.
- CASIO COMPUTER CO., LTD. shall not be held liable for any lost profits or claims from third parties arising out of the use of this product or this manual.
- CASIO COMPUTER CO., LTD. shall not be held liable for any loss or lost profits due to loss of data due to malfunction or maintenance of this product, or any other reason.
- The sample screens shown in this manual are for illustrative purposes only, and may not be exactly the same as the screens actually produced by the product.

Contents

Safety Precautions	7
Operating Precautions	13
About the Light Source Unit.....	13
Projector Light Emission (XJ-UT Series)	13
Do not block light output or look directly into the lens! (XJ-F Series)	14
Laser and High Temperature Precautions (See the label on the projector)	15
Other Precautions	17
Precaution when Handling the Projector after Use	19
Getting Ready	20
Unpacking	20
Operation Flow to Projection.....	20
General Guide	22
Key and Indicator Panel	23
Back Terminals.....	24
Placing the Projector on a Desk or on the Floor	25
Adjusting the Vertical Angle of the Projector	25
Setup Precautions	26
Connecting with Another Device.....	27
Connecting a Computer	27
Connecting to a Video Device	28
Outputting Audio from the Projector to Another Device.....	30
Connecting a Microphone (XJ-UT Series, XJ-F21XN, XJ-F211WN).....	31
Connecting to a Network with a LAN Cable (Network Models Only)	31
Connecting a Wireless Adapter (Network Models Only).....	32
LOGO Terminal (Firmware Updates, User Logo Transfers)	32
Connecting a Scientific Calculator (Network Models Only).....	33
SERIAL Terminal (Projector Control Using Commands).....	33
USB Power	34

Cover Included with the YW-41 Wireless Adapter	34
Attaching and Removing the Cable Cover (XJ-UT Series)	35
Remote Controller	36
Operating the Projector	37
Turning the Projector On or Off	37
To turn on the projector	37
To turn off the projector	37
Direct Power On	37
Auto Power Off	38
Auto Projection Off	38
Selecting an Input Source (INPUT)	38
Resolution	38
Using Auto Input Search	39
Triggering an Auto Input Search Operation Manually	39
Auto Input Search Following Power On	39
Auto Input Search Sequence	40
Changing the Input Source Manually	41
Relationship Between Image Input and Audio Input	41
Using Auto Projection Off	43
Enabling and Disabling Auto Projection Off	44
Auto Projection Off Projection Light Control	44
Basic Image and Audio Operations During Projection	45
Flipping the Projected Image Horizontally (Mirror Mode)	47
Light Control	48
Digital Screen Shift	49
Projecting a Template	49
To project a template	49
To change the template type (XJ-UT352W, XJ-F11X, XJ-F101W)	50
To change the template type (Network Models)	50
Test Pattern Projection	51
Control Panel Lock	51
Configuring Remote Control ID and Projector ID Settings	52
Using the Countdown Timer (TIMER)	52
Showing and Hiding the Countdown Timer	52

Using the Presentation Timer (TIMER)	54
To display the timer	54
To display the timer function menu	54
To configure timer settings.....	54
Timer Operations	55
Using the Setup Menu (MENU)	56
Setup Menu Settings	56
Using a Password	63
Configuring Password Settings.....	63
Using the Password Feature.....	64
If you forget your password.....	64
Cleaning the Projector.....	65
Cleaning the Projector Exterior	65
Cleaning the Lens.....	65
Cleaning Vents	65
Troubleshooting	66
Normal Operation Indicators	66
Error Indicators and Messages	67
Error Messages	67
Indicator Status When an Error Occurs.....	67
Projector Troubleshooting.....	69
Checking the Serial Number and Board Number.....	71
Appendix	72
Supplying USB Power to Another Device	72
Mounting the Projector on a Wall (XJ-UT Series).....	73
Hanging the Projector from a Ceiling (XJ-F Series).....	73
Using the MONITOR OUT Terminal (XJ-UT Series)	74
Projection Distance and Screen Size	75
Aspect Ratio Setting and Projection Image	77
Supported Signals.....	79
Projector RS-232C Control	80



Specifications	83
All Series.....	83
XJ-UT Series	84
XJ-F Series	85
TCO Certified Document URL.....	86

Safety Precautions

Thank you for selecting this CASIO product. Be sure to read these “Safety Precautions” before trying to use it. After reading this User’s Guide, keep it in a safe place for future reference.

About safety symbols

Various symbols are used in this User’s Guide and on the product itself to ensure safe use, and to protect you and others against the risk of injury and against material damage. The meaning of each of the symbols is explained below.

 Danger	Indicates something that creates a major risk of death or serious personal injury.
 Warning	Indicates something that creates a risk of death or serious personal injury.
 Caution	Indicates something that creates a risk of minor personal injury or physical damage.

Icon Examples



A triangle indicates a situation against which you need to exercise caution. The example shown here indicates you should take precaution against electric shock.



A circle with a line through it indicates information about an action that you should not perform. The specific action is indicated by the figure inside the circle. The example shown here means disassembly is prohibited.



A black circle indicates information about an action that you must perform. The specific action is indicated by the figure inside the circle. The example shown here indicates you must unplug the power cord from the power outlet.

Precautions During Use

Warning

- **Adult supervision is required whenever there are young children present and especially when there is the possibility of young children coming into contact with the projector.**

Battery Precautions

- **Should fluid leaking from a battery get on your skin or clothing, immediately rinse it off with clean water.**



Battery fluid getting into the eyes creates the risk of eyesight loss, etc. Rinse the eyes and then immediately contact a physician.

Abnormalities (Smoke, Odor, Heat Generation, etc.)

- **Do not use the product if it is emitting smoke, odor, heat, or exhibiting any other abnormality. Do not use the product after it has been dropped or otherwise damaged.**



Doing so creates the risk of fire and electric shock. Immediately perform the steps below.

1. Unplug the power plug from the power outlet.
2. Contact your original retailer or a CASIO Service Center.

Do not use the product if it is malfunctioning.

● Do not continue using the product if its display is abnormal or if it is malfunctioning.



Continued use creates the risk of fire and electric shock. Immediately perform the steps below.

1. Turn off power.
2. Unplug the power plug from the power outlet.
3. Contact your original retailer or a CASIO Service Center.

Power Cord

● Observe the precautions below in order to avoid power cord fire and electric shock.



- Use only the included power cord.
- Do not plug the power cord into an outlet with the wrong voltage rating.
- Ground the power cord before plugging it into a power outlet.
- Unground the power cord after unplugging it from the power outlet.
- Should the power cord become damaged, contact your original retailer or a CASIO Service Center.



- Use the included power cord with this product only.
- Do not plug the power cord into an outlet with the wrong voltage rating.
- Do not plug into an overloaded extension cord or power outlet.
- Do not share the outlet supplying power to the product with other devices.
If you are using an extension cord, make sure that the ampere rating of the extension cord is appropriate for this product.
- Do not cover the power cord with a blanket or other material during use, and keep it away from heating devices.
- Do not place heavy objects on the power cord and do not leave it bundled during use.
- Do not locate any objects in the vicinity of the power plug and keep it easily accessible so it can be unplugged in case of an emergency.



- Do not subject a power cord to heat or attempt to modify it, and avoid damaging it.
- Do not subject the power cord to excessive bending, twisting, or pulling.
- Make sure the power cord is not pinched between the wall and the rack or table where the product is located, and never cover the power cord with a cushion or other object.

● Do not touch the plug with wet hands.



Doing so creates the risk of electric shock.

Avoiding Water and Foreign Matter

● Do not allow water, other liquids (sports drinks, seawater, animal or pet urine, etc.), or foreign objects (metal fragments, etc.) to get into the product or the AC adaptor. Should any such matter get into the product, immediately perform the steps below.



Continued use creates the risk of fire and electric shock.

1. Turn off power.
2. Unplug the power plug from the power outlet.
3. Contact your original retailer or a CASIO Service Center.

● Do not locate a flower vase or other liquid container on top of or next to the product or AC adaptor.



Liquid spilling from a container creates the risk of fire and electric shock.

Disassembly and Modification

● Do not attempt any disassembly or modification.

For any internal inspection, adjustment, or repair, contact your original retailer or a CASIO Service Center.



The product contains a large number of high-voltage components that create the risk of electric shock and burn injury.

Suffocation and Choking Risks

- **Do not allow anyone to play with the plastic bags used for product packaging.**



Plastic bags create the risk of suffocation when placed over the head, when swallowed, etc. Particular care is required in areas where young children are present.

Dropping and impact



Continued use of the projector after it has been damaged by dropping or other mistreatment creates the risk of fire and electric shock. Immediately perform the following steps.

1. Turn off the projector.
2. Unplug the projector.
3. Contact your original dealer or authorized CASIO service center.

Disposal by burning



Never try to dispose of the projector by burning it. Doing so can cause an explosion, which creates the risk of fire and personal injury.

Avoid Looking into the Light

- **Do not look directly into the lens, the intake or exhaust vents while the light is on.**



The strong light emitted by the light source creates the risk of eye damage.

Vent Blockage

- **Do not allow blocking of the intake or exhaust vents. Be sure to observe the precautions below.**



Blocked vents causes internal heat buildup, which creates the risk of fire and malfunction.

- XJ-UT Series: Maintain a distance of at least 6 cm (2.4 inches) between the front of the projector (from which light is being emitted) and the projection surface (screen). Maintain a distance of at least 30 cm (11.8 inches) between surfaces and the other sides of the projector.
- XJ-F Series: Allow at least 30 cm (11.8 inches) between the projector and walls.
- Do not insert the product into a space where air circulation is poor, and do not cover it with a blanket, etc.
- Do not use the product while it is on a carpet, blanket, towel, or other soft material, or on a seat with soft covering. Use the product on a hard, flat surface.

Keep the Cabinet Closed

- **Do not try to open the projector cabinet.**



Doing so creates the risk of electric shock.

Intake and Exhaust Vents

- **Do not touch the intake and exhaust vents during projection, and do not place any plastic or other objects or material close to intake/exhaust vents. Also, do not place the product on top of such materials.**



Doing so creates the risk of burn injury, and deformation and discoloration of the object or material.

Objects Blocking Projection

- **Make sure there are no objects that can block the light in front of the lens while projecting.**



Such conditions create the risk of fire.

Aquarium, Other Water Tank

- **Make sure there is no aquarium or any other type of water tank that can produce a lens effect in front of the lens while projecting.**



Such conditions create the risk of fire.

Lens

- **Do not touch the lens with your hand.**



Doing so creates the risk of burn injury and accident.

Storage and Operation Locations

- **Do not store or use the product in any of the locations described below.**



Doing so creates the risk of fire and electric shock.

- Areas subjected to large amounts of moisture and dust
- Food preparation areas, near a humidifier, or in areas where the product is exposed to oil smoke or water vapor
- Areas where there is strong vibration
- Other areas where there are high or low temperatures (Operating temperature range: 5°C to 35°C)

- **Do not place the product on an unsteady platform, on a high shelf, or in any other unstable location.**



Dropping and tipping over creates the risk of personal injury.

Location

- **Do not place heavy objects on the product or climb up on it.**



Doing so creates the risk of fire and electric shock.

- **Do not leave the product in a lavatory, a bathroom, or anywhere else there is the chance that it will become wet.**



Moisture creates the risk of fire and electric shock.

- **Lock the wheels. (When using the product on a handcart, etc.)**



Dropping and tipping over create the risk of personal injury.

In the case of a lightning storm, do not touch the device plugged into the power outlet



Lightning creates the risk of electric shock.

Remote controller



Never try to take the remote controller apart or modify it in any way. Doing so creates the risk of electric shock, burn injury, and other personal injury. Be sure to leave all internal inspection, adjustment, and repair up to your original dealer or authorized CASIO service center.



Never allow the remote controller to become wet. Water creates the risk of fire and electric shock.

YW-41 wireless adapter

- **Keep the wireless adaptor out of the reach of small children.**



Accidental swallowing of the wireless adaptor creates the risk of suffocation and personal injury.

- **Radio waves emitted by the YW-41 wireless adapter**



Never use this product inside of an aircraft or medical facility, or in any other location where use of such devices is prohibited. Radio waves can have an effect on the operation of electronic equipment and medical equipment, and cause accidents.



Do not use this product in the vicinity of high-precision electronic instruments or electronic devices that handle weak radio signals. Radio waves can have an effect on the operation of such equipment, and cause accidents.

- If you are using a pace maker or any other electronic medical device, be sure to consult your physician or device manufacturer before using this product.

- **Do not use flammable gas sprays nearby**



Do not spray flammable gas into or in the vicinity of the projector. The gas may ignite and create the risk of fire.

Effect on Other Electronic Devices

- **When using the product in a medical facility or aircraft, follow the instructions of local personnel and crew concerning use of such devices. Do not use the product in an area where use of such devices is prohibited.**



Electromagnetic waves and other signals emitted by this product may affect measuring instruments and create the risk of accident.

- **Do not use the product in the vicinity of high-precision electronic equipment or any electronic equipment that handles weak signals.**



Doing so can cause misoperation and other problems in the electronic equipment, and creates the risk of accident.

- **Keep this product away from the chest area of any individual fitted with a cardiac pacemaker.**



Cardiac pacemakers and similar devices can be affected by electromagnetism. Should anyone fitted with a cardiac pacemaker or other medical device ever experience any abnormality, move the product away and contact a physician.

Caution

Power Cord

- **Observe the precautions below in order to avoid power cord fire and electric shock.**



- Insert the power plug into the outlet as far as it will go.
- At least once a year, unplug the power plug from the power outlet and use a dry cloth to wipe away any dust buildup from the area between the prongs of the plug.
- Before moving the product, turn it off and unplug from the power outlet.
- After use, unplug the power plug from the power outlet.
- If you do not plan to use the product for a long time, unplug from the power outlet.
- When unplugging the power plug, do not pull on the power cord. Grasp the plug.
- Do not use detergent when cleaning the power cord, especially the power plug and jack parts.



Backup of important data



Be sure to keep separate written records of all data stored in projector memory. Memory data can be lost due to breakdown, maintenance, etc.

Battery Precautions

● Observe the precautions below.

Failure to do so can cause a battery to rupture, creating the risk of fire, personal injury, and soiling of nearby objects by leaking fluid.



- Load a battery with its poles (plus (+) and minus (-)) facing correctly.
- If you do not plan to use the product for a long time, remove batteries.
- Replace the batteries as soon as possible after they go dead.



- Do not try to take a battery apart and never allow a battery to become shorted.
- Do not charge a non-rechargeable battery.
- Do not mix old and new batteries.
- Do not mix different battery types.
- Do not expose a battery to heat or throw it into fire.
- Use only the specified type of battery.

Magnetism



This projector has a magnet inside. Because of this, it should not be used in the vicinity of anyone wearing a pacemaker or any other electric medical device. Should any problem arise, move the projector away from the person experiencing the problem and consult a physician.



Keep the projector away from floppy disks, magnetic cards, magnetic tapes, prepaid cards, checks, and any other media that uses magnetic recording. The projector can corrupt data recorded on magnetic media.

Other

Allowing dust to build up inside the projector by not cleaning it for long periods creates the risk of fire and accident, and can cause loss of projection luminosity. Contact your original dealer or authorized CASIO service center once a year about having the interior of the projector cleaned. Note that you will be charged for cleaning.

User Maintenance

● Before cleaning the product, turn off power and unplug the AC adaptor from the power outlet.



Failure to do so creates the risk of electric shock. Leaving the AC adaptor plugged in creates the risk of damage to the power cord, fire, and electric shock.

● Once a year, request internal cleaning (charged separately) from your original retailer or a CASIO Service Center.



Long-term dust build-up creates the risk of fire and malfunction.

Operating Precautions

About the Light Source Unit

- The projector's light source unit uses a laser and LED.
- The life of the light source unit is rated at approximately 20,000 hours. The actual life will depend on use conditions, the settings configured on the setup menu, and differences between each individual light source unit.
- The light source unit is warranted for the period noted on the warranty certificate or for 6,000 hours, whichever comes first.
- The failure of the light source unit to light or a noticeable drop in light source unit brightness indicates the end of the light source unit's life. Contact your original dealer or authorized CASIO service center for replacement. Note that problems caused by unauthorized projector disassembly or modification are not covered by the warranty and are not eligible for repair by CASIO.

Projector Light Emission (XJ-UT Series)





- Never look directly into the lens while the light is on.
Particular care is required when children are present.



RISK GROUP 2

- As with any bright light source, do not stare into the beam, RG2 IEC 62471-5:2015.

Do not block light output or look directly into the lens! (XJ-F Series)

 <ul style="list-style-type: none"> • Never block light output while the light is on. 	 <ul style="list-style-type: none"> • Never look directly into the lens while the light is on. Particular care is required when children are present.
--	---

警告! WARNING! AVERTISSEMENT!

<p>投影光を塞がない! 不要遮挡投影光线! DO NOT BLOCK LIGHT OUTPUT! NE PAS BLOQUER LA SORTIE DE LA LUMIERE!</p> 	<p>光源をのぞかない! 不要窥视光源! DO NOT LOOK INTO THE LIGHT SOURCE! NE PAS REGARDER DIRECTEMENT VERS LA SOURCE LUMINEUSE!</p> 
---	---

**RISK GROUP 2
RISIKOGRUPPE 2**

CAUTION: Possibly hazardous optical radiation emitted from this product. Do not stare at operating lamp. May be harmful to the eye.

VORSICHT: Dieses Produkt gibt potentiell gefährliche optische Strahlung ab. Starren Sie nicht auf die Betriebslampe. Dies könnte die Augen schädigen.

Projection Lamp Caution

This label is a “RISK GROUP 2” caution label required under the IEC62471 standard.

RISK GROUP 2 (Moderate Risk) lamps exceed the limits of Exempt Group (No Hazard) standards. Do not stare at the operating lamp during projection. Doing so may be harmful to the eyes.

Avoid looking into the projection lens on the front of the projector when turning on power, which creates the risk of looking directly at the operating lamp.

Laser and High Temperature Precautions (See the label on the projector)

Laser Precautions (Label ①, Label ②)

Non- U.S. Label ①: This projector is a Class 1 laser device that conforms to IEC 60825-1: 2014.

U.S. Label ②: This projector is a Class 2 laser device that conforms to IEC 60825-1: 2007.

- This projector has a built-in laser module. Disassembly or modification is very dangerous and should never be attempted.
- Any operation or adjustment not specifically instructed by the user's guide creates the risk of hazardous laser radiation exposure.

Vent Outlet Precautions (Label ③)

	<ul style="list-style-type: none"> • Vent outlets become very hot during projection. Never touch vents or allow them to become blocked. • Do not insert foreign objects.
--	--

■ XJ-UT Series

Except for USA
クラス 1 レーザー製品
CLASS 1 LASER PRODUCT
IEC 60825-1: 2014

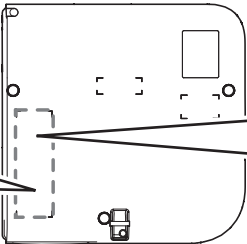

Bottom

⚠ 高温注意 CAUTION HOT
⚠ 注意高温 ATTENTION CHAUD
⚠ 고온주의 VORSICHT HEISS

⚠ 注意
• 내부에異物をいれなくてください。・投映中は、排気口が高温になります。排気口に触れたりふさがないでください。

⚠ Caution
• Do not insert foreign objects. •Vent outlets become very hot during projection. Never touch vents or allow them to become blocked.

⚠ 주의
• 내부에 이물질을 넣지 마십시오. • 투영중에는 배기구가 고온이 됩니다. 질대로 배기구를 만지거나 막지 마십시오.

⚠ Attention
• Ne pas laisser pénétrer des matières étrangères l'intérieur. • Les sorties d'air deviennent très chaudes pendant la projection. Ne jamais les toucher ni les obstruer.

⚠ 注意
• 不要に異物混入。• 使用中投影机の通风口会非常热。切勿触摸通风口或使其被挡住。

⚠ VORSICHT
• Stecken Sie keine Fremdkörper in das Gerät. • Die Entlüftungsoffnungen werden bei der Projektion sehr heiß. Berühren oder blockieren Sie die Öffnungen nicht.

XJ-○○○ XXXXXXXXXXX-XXXXXX
Production Date: YYYY/MM

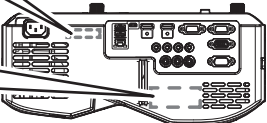

Side

⚠ 注意
• 不要に異物混入。• 使用中投影机の通风口会非常热。切勿触摸通风口或使其被挡住。

⚠ VORSICHT
• Stecken Sie keine Fremdkörper in das Gerät. • Die Entlüftungsoffnungen werden bei der Projektion sehr heiß. Berühren oder blockieren Sie die Öffnungen nicht.

For USA
LASER RADIATION IEC60825-1:2007
DO NOT LOOK INTO THE LIGHT SOURCE
CLASS 2 LASER PRODUCT
MAXIMUM OUTPUT POWER: <36mW
WAVELENGTH: 635nm
Complies with 21 CFR Parts 1040.10 and 1040.11 except for deviations pursuant to Laser Notice No.20 dated June 29, 2007.

Label ③

Label ①

Label ②

■ XJ-F Series

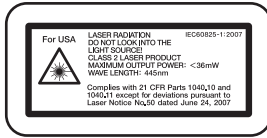

Label ②



Label ①

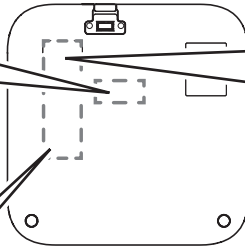
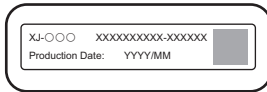

Bottom

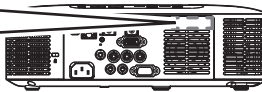

Rear

高温注意 CAUTION HOT
注意高温 ATTENTION CHAUD
고온주의 VORSICHT HEISS

注意
 ・内部に異物をいれしないでください。・投映中は、排気口が高温になります。排気口に触れたりあざがないでください。

Caution
 ・Do not insert foreign objects.・Vent outlets become very hot during projection. Never touch vents or allow them to become blocked.

주의
 ・내부에 이물질을 넣지 마십시오.・투영중에는 배기구가 고온이 됩니다. 질대로 배기구를 만지거나 막지 마십시오.

Attention
 ・Ne pas laisser pénétrer des matières étrangères l'intérieur.
 ・Les sorties d'air deviennent très chaudes pendant la projection. Ne jamais les toucher ni les obstruer.

注意
 ・不要让异物混入。・使用过程中投影机通风口会非常热。切勿触摸通风口或使其被挡住。

VORSICHT
 ・Stecken Sie keine Fremdkörper in das Gerät.
 ・Die Entlüftungsöffnungen werden bei der Projektion sehr heiß. Berühren oder blockieren Sie die Öffnungen nicht.

Label ③

Other Precautions

This projector is made of precision components. Failure to observe the following precautions can result in inability to correctly save data and malfunction.

● **Never use or store the projector in the following locations. Doing so creates the risk of malfunction of and damage to the projector.**

- Locations subjected to electrostatic charge
- Locations subjected to temperature extremes
- Locations where there is extreme moisture
- Locations subjected to sudden temperature changes
- Locations where there is a lot of dust
- On a shaky, slanted, or otherwise unstable surface
- Locations where there is the danger of getting wet
- Locations where there are large amounts of oil smoke or other smoke
- Locations where there is the risk of salt damage
- Locations where corrosive gas (such as the sulfur gas at hot springs) is generated

● **Never use the projector in an environment where large amounts of oil smoke are present. In particular, ceiling or wall mounting the projector in an environment where large amounts of oil smoke are present can result in the projector falling from its mounting.**

● **Ensure that the remote control signal receiver is not exposed fluorescent light, sunlight, or other strong light. Strong light can cause malfunction.**

● **Avoid using the projector under the following conditions. Such conditions create the risk of malfunction of and damage to the projector.**

- Avoid areas subject to temperature extremes (operating temperature range is 5°C to 35°C (41°F to 95°F)).
- Never place heavy objects on the projector or climb on top of the projector.
- Never insert or allow foreign objects to drop into the projector.
- Never place a vase or any other container of water on top of the projector.

● **Whenever setting the projector down or performing any operation that involves moving or reorienting it, take care that you do not pinch your fingers under the projector.**

● **To avoid running down the batteries, store the remote control unit so its keys are not pressed inadvertently.**

● **Never leave dead batteries inside the remote controller for a long time.**

Dead batteries can leak, which leads to malfunction of and damage to the remote controller. Be sure to replace the batteries at least once every one year, no matter how much you use the remote controller during that time.

● **Clean with a soft, dry cloth.**

When very dirty, use a soft cloth that has been dampened in a weak solution of water and a mild neutral detergent. Wring all excess water from the cloth before wiping. Never use thinner, benzine, or any other volatile agent to clean the projector. Doing so can remove its markings and cause staining of the case.

● **Missing Screen Dots**

Though this projector is manufactured using the most advanced digital technology available today, some of the dots on the screen may be missing. This is normal, and does not indicate malfunction.

- **Never subject the projector to strong impact while it is projecting.**

If the projector is accidentally subjected to strong impact, the projection image will momentarily go blank. The image will reappear after some time, but it may be the wrong color or it may be accompanied by an error message.

If the projected image is the wrong color, re-select the current input source. If this does not return the projected image to its proper color, turn projector power off and then back on again.

If the image reappears with an error message, correct the problem in accordance with the indicator explanations under “Error Indicators and Messages” (page 67).

- **Use a power outlet near the projector. Always use the projector so that the power cord can be easily unplugged.**

- **The YW-41 Wireless Adapter (included or purchased separately) supports the 2.4GHz band only.**

- **Keystone Correction and Image Quality**

Performing keystone correction causes the image to be compressed before it is projected. This can result distortion of the image or a loss of image quality. If this happens, change orientation of the projector and/or screen so it conforms as much as possible to the illustration under “Placing the Projector on a Desk or on the Floor” (page 25).

If image quality is the highest priority, turn off keystone correction and position the projector so it is pointed straight at the screen.

- Even if your projector is still within the warranty period, you will be charged for repair if a problem is due to running the projector non-stop for very long periods (like 24 hours) or if the projector was set up and used without following the “Setup Precautions” (page 26).
- Use under high ambient temperature or in environments subjected to large amounts of dust, oil smoke, tobacco smoke, or other types of smoke can shorten the replacement cycles and require more frequent replacement of the optical engine and other components. Note that you are charged for such replacement. For details about replacement cycles and fees, contact an authorized CASIO service center.

- **Condensation**

Moving the projector from a cold room to a heated room, turning on a heater in a cold room, and other similar conditions can cause condensation (fogging) to form on the projector lens and/or inside the projector, which will make the projected image appear out of focus and can lead to malfunction and other trouble. If this happens, turn off the projector and wait for a while until the condensation clears naturally. When it does, you will be able to project images normally.

- **Power Supply to External Equipment**

Turning off projector power also cuts power being supplied to external equipment. Note that power being supplied is also cut when the projector is turned off due to restarting by its self-check function or Auto Power Off, due to some error, or for any other reason. Depending on the external equipment being used, cut off of the power supply may cause data that is being edited to be lost or corrupted. Make it a habit to frequently save data on external equipment being powered by the projector. Note that CASIO COMPUTER CO., LTD. shall be held in no way liable for any loss or corruption of data.

- **Disposing of batteries**

Make sure that you dispose of used batteries in accordance with the rules and regulations in your local area.

- **Be sure to follow all applicable local laws and regulations, and do not dismantle the projector when disposing of it.**

Precaution when Handling the Projector after Use

The projector's exhaust vents and the area around the vents become very hot during operation, and will still be hot immediately after turning off the projector. When moving the projector, be sure to first turn off power and unplug its power cord from the power outlet. Hold the projector as shown in the illustration below.

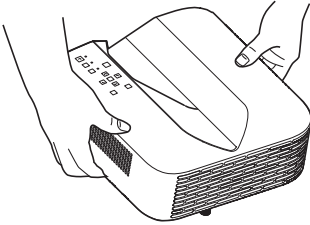

XJ-UT Series

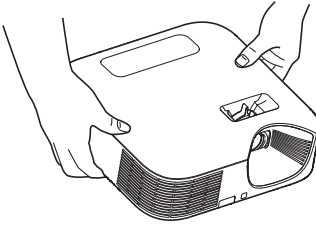

XJ-F Series

Getting Ready

Unpacking

As you unpack the projector, check to make sure that all of the items listed below are present.

- Projector
- Wireless remote controller YT-161
- Test Batteries (AAA-size × 2)
- AC Power Cord
- Cable cover (XJ-UT Series only)
- Wireless adapter YW-41 (XJ-UT312WN only)
- “Where to find the User’s Guide” sheet
- Warranty

Operation Flow to Projection

This section explains the operational flow up to the point that projection is started.

1. Load the test batteries that come with the projector into the remote controller.

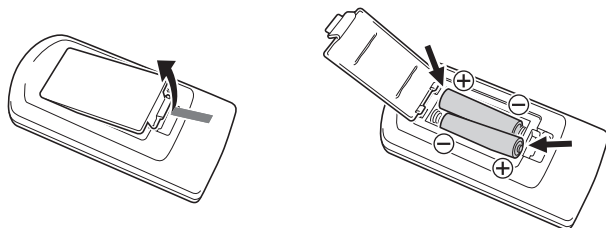

- Use only alkaline batteries to power the remote controller.

2. Place the projector onto a table, desk, or stand that is level and firm, making sure that you allow enough room around it.

- “Safety Precautions” (page 7), “Operating Precautions” (page 13)
- “Placing the Projector on a Desk or on the Floor” (page 25), “Setup Precautions” (page 26)

You will need to purchase special hardware to mount this projector on a wall. For details, contact the retailer where you purchased the projector.

3. Adjust the vertical angle of the projector.

- “Adjusting the Vertical Angle of the Projector” (page 25)

4. Use the supplied power cord to plug the projector into a power outlet.

5. Connect the projector to an image output device and/or audio output device, and then turn on each device.

- “Connecting with Another Device” (page 27)

6. Press the [⏻] key to turn on the projector.

- The first time you turn on the projector, a “Language” window will appear in the center of the projection screen. Select the language you want.

- 7. Use the [INPUT] key to select the input source.**
 - “Selecting an Input Source (INPUT)” (page 38)
- 8. To adjust the projected image size, rotate the zoom ring (XJ-F Series).**
- 9. Focus the image.**
 - **XJ-UT Series:**
Slide the focus lever (page 22) upwards or downwards.
 - **XJ-F Series:**
Rotate the focus ring (page 22).
- 10. Perform keystone correction and adjust brightness as required.**
 - **XJ-UT Series:**
“Correct vertical and horizontal keystone manually (KEYSTONE)” (page 45), “Light Control” (page 48).
 - **XJ-F Series:**
“Correct vertical keystone manually (KEYSTONE)” (page 45), “Light Control” (page 48).
- 11. After you finish projecting, press the [⏻] key to turn off the projector.**



Note

- This product is also designed for IT power distribution system with phase-to-phase voltage 230V.

General Guide

XJ-UT Series

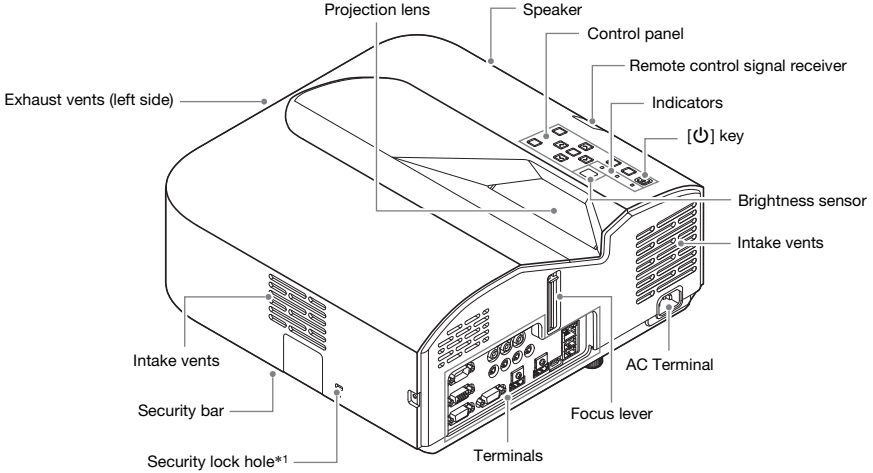

XJ-F Series

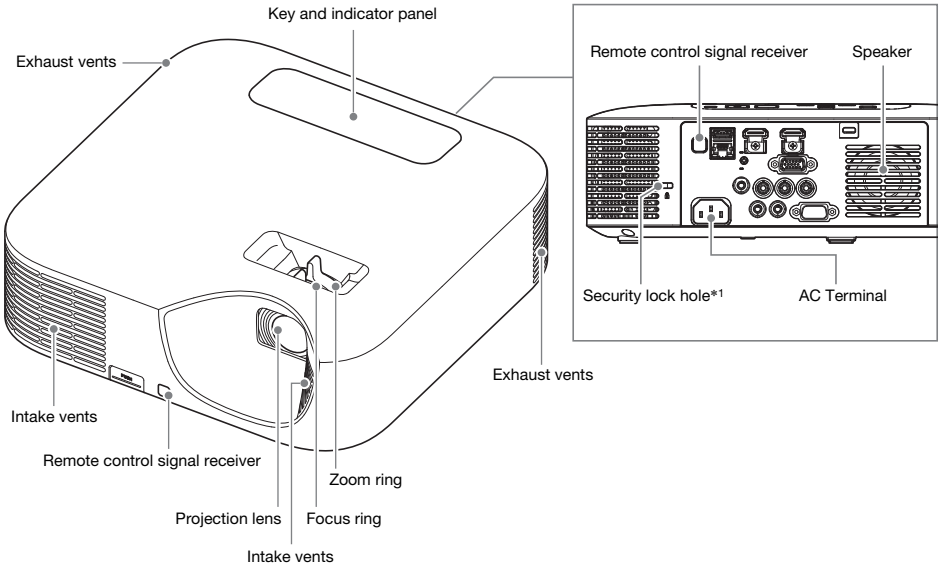

*1 The anti-theft lock hole is provided for connection of an anti-theft chain. Visit the Kensington Lock Website at <https://www.kensington.com/> for more information.

Key and Indicator Panel

XJ-UT Series

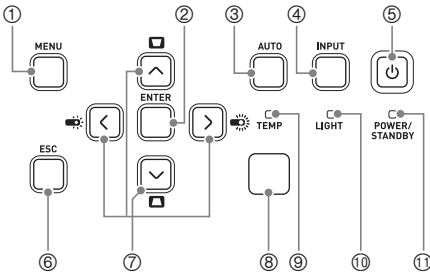

- ①[MENU] key
- ②[ENTER] key
- ③[AUTO] key (XJ-UT Series)
- ④[INPUT] key
- ⑤[ON/Stand-by ⏻] key
- ⑥[ESC] key
- ⑦ Cursor keys (⤴/⤵/⤶/⤷)
- ⑧ Brightness sensor
- ⑨ TEMP indicator (XJ-UT Series)
- ⑩ LIGHT indicator (XJ-UT Series)
- ⑪ POWER/STANDBY indicator
- ⑫ STATUS indicator (XJ-F Series)

XJ-F Series

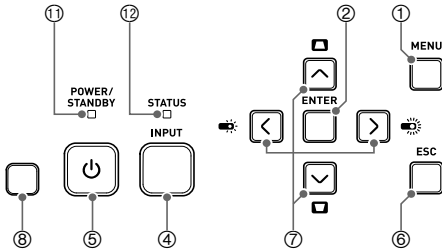

Back Terminals

XJ-UT Series

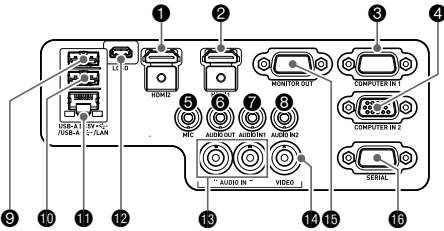

1	HDMI 2 terminal (XJ-UT352W / XJ-UT352WN)
2	HDMI 1 terminal (XJ-UT352W / XJ-UT352WN) HDMI terminal (XJ-UT312WN)
3	COMPUTER IN 1 terminal
4	COMPUTER IN 2 terminal
5	MIC terminal
6	AUDIO OUT terminal
7	AUDIO IN 1 terminal
8	AUDIO IN 2 terminal
9	USB-A/DC 5V port (XJ-UT312WN / XJ-UT352WN) DC 5V port (XJ-UT352W)
10	USB-A port (XJ-UT312WN / XJ-UT352WN)
11	LAN terminal (XJ-UT312WN / XJ-UT352WN)
12	LOGO terminal
13	AUDIO IN R/L terminals
14	VIDEO terminal
15	MONITOR OUT terminal
16	SERIAL terminal

XJ-F Series

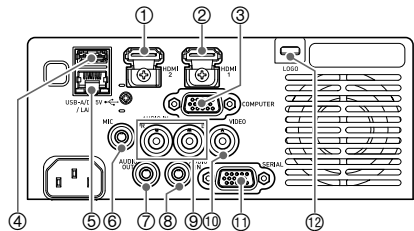

1	HDMI 2 terminal
2	HDMI 1 terminal
3	COMPUTER IN terminal
4	USB-A/DC 5V port (XJ-F21XN / XJ-F211WN) DC 5V terminal (XJ-F11X / XJ-F101W)
5	LAN terminal (XJ-F21XN / XJ-F211WN)
6	MIC terminal (XJ-F21XN / XJ-F211WN)
7	AUDIO OUT terminal
8	AUDIO IN terminal
9	AUDIO IN R/L terminals
10	VIDEO terminal
11	SERIAL terminal
12	LOGO terminal

Placing the Projector on a Desk or on the Floor

Locate the projector on a desk, table, or stand that is firm and level. Make sure that you allow sufficient space around the sides and back of the projector for proper ventilation. The illustrations below show how the projector should be oriented relative to the screen for optimum projection.

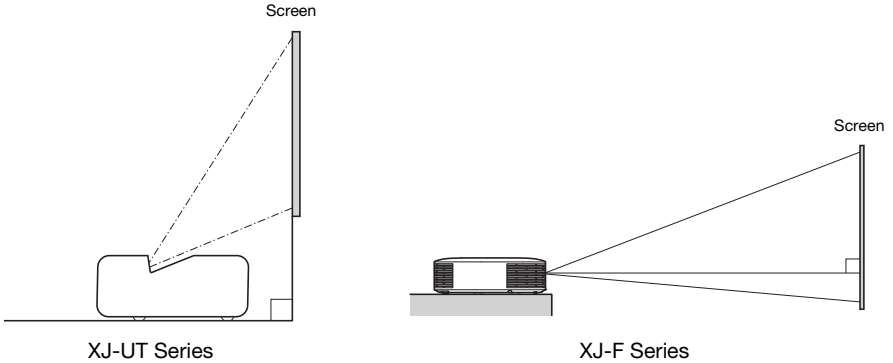

Test Pattern

You can project a test pattern when setting up the projector to help determine the proper image size, projector orientation, etc. For details, see “Test Pattern Projection” on page 51.

Adjusting the Vertical Angle of the Projector

XJ-UT Series

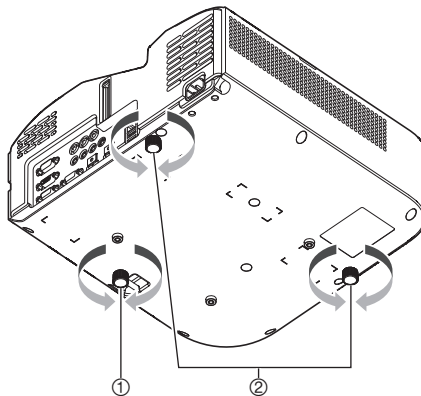

- ① Rotate the single foot on the bottom front of the projector to fine adjust the projector's vertical angle.
- ② Rotate the two feet on the bottom back of the projector to fine adjust the projector's horizontal angle.

XJ-F Series

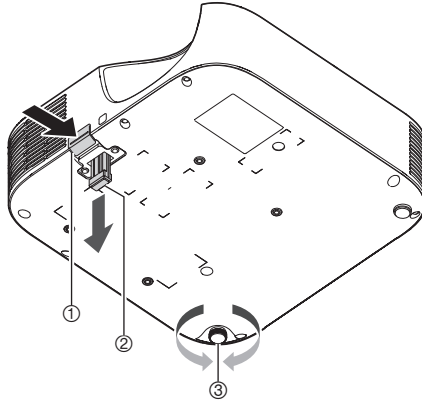

- ① Lift up the front of the projector and press the release button. This causes the front foot to drop from the bottom of the projector.
- ② While holding down the release button, raise and lower the front of the projector. When the front foot is the height you want, release the release button. The front foot will lock at that position.
- ③ Make fine adjustments to the horizontal tilt of the projector by rotating the rear foot. Only one of the rear feet is adjustable to a height of ± 3 mm. The adjustable rear foot has a click position, which indicates the setting where its height is the same as that of the other rear foot.

Setup Precautions

- Use a conveniently located power outlet that you can reach easily when you need to unplug the projector.
- Airflow from air conditioning equipment can blow the heat being exhausted from the area around the projector's lens in a way that causes heat ripples to appear in the projected image. If this happens, adjust the airflow of the air conditioning equipment or move the projector.

XJ-UT Series

- Maintain a distance of at least 6 cm (2.4 inches) between the front of the projector (from which light is being emitted) and the projection surface (screen). Maintain a distance of at least 30 cm (11.8 inches) between surfaces and the other sides of the projector. There should be no other objects within the above distances from the projector. Particular care is required to keep objects away from projector air intake and exhaust openings.

XJ-F Series

- Do not located any objected within 30 cm (11.8 inches) around the projector. Particular care is required to keep objects away from projector air intake and exhaust openings.

Connecting with Another Device

Before starting projection, you first need to connect a computer, video device, and/or other devices to the projector. When selecting a cable, make sure that the shapes of its connectors match the shapes of the terminals on the projector and the devices being connected.

Connecting a Computer

Connect to the HDMI terminal or analog RGB terminal (VGA terminal) of the computer.

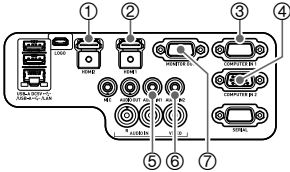

XJ-UT Series

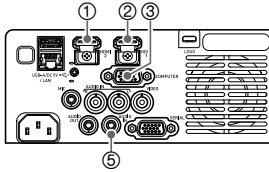

XJ-F Series

HDMI Connection

With this type of connection, the video signal and audio signal from a computer are input simultaneously using a single cable.

Projector Terminal	Connection Cable	Computer Terminal
① HDMI 2 or ② HDMI 1*1	HDMI cable  HDMI Type A	HDMI Out terminal

*1 An XJ-UT312WN model has a ②HDMI terminal only.

Analog RGB Connection

With this type of connection, the RGB cable inputs only the image signal of the computer. If you also want to output audio from the computer, you will need to connect an audio cable.

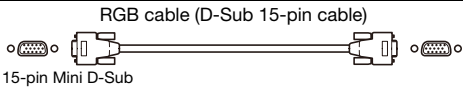
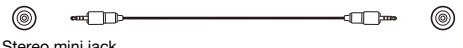
Projector Terminal	Connection Cable	Computer Terminal
③COMPUTER IN 1*2 or ④COMPUTER IN 2	 <p>RGB cable (D-Sub 15-pin cable) 15-pin Mini D-Sub</p>	Analog RGB Out (VGA) terminal
⑤AUDIO IN 1*3 or ⑥AUDIO IN 2	 <p>Audio cable Stereo mini jack</p>	Headphones jack or other audio output jack.

*2 An XJ-F Series model has a COMPUTER IN terminal only.

*3 An XJ-F Series model has an AUDIO IN terminal only.



Note

- An XJ-UT Series model has a ⑦MONITOR OUT terminal that lets you directly output the signal being input to the ③COMPUTER IN 1 terminal or ④COMPUTER IN 2 terminal to an external display. For details, see “Using the MONITOR OUT Terminal (XJ-UT Series)” (page 74).
- The relationship between the image output terminal and audio output terminal can be changed as required. Note that the combinations shown in the table are initial default settings. For details, see “Relationship Between Image Input and Audio Input” (page 41).

Connecting to a Video Device

With this type of connection, connect to the HDMI, component video, or composite video terminal of the video device.

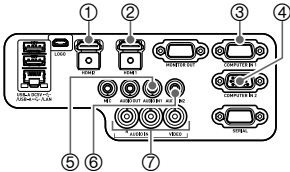

XJ-UT Series

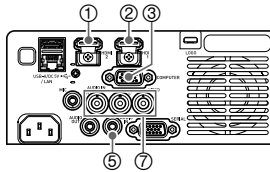

XJ-F Series

HDMI Connection





With this type of connection, the video signal and audio signal from the video device are input simultaneously using a single cable.

Projector Terminal	Connection Cable	Video Device Terminal
①HDMI 2 or ②HDMI 1*1	 <p>HDMI cable HDMI Type A</p>	HDMI Out terminal

*1 An XJ-UT312WN model has a ②HDMI terminal only.

Component Video Connection

Video device component video output terminals are grouped as a set of three: Y, Cb, Cr or Y, Pb, Pr. Connect the component video cable so the colors of its three plugs match the colors of the terminals (green for Y, blue for Cb or Pb, red for Cr or Pr). If you want to output the audio of the video device through the projector's speaker, you also will need to connect an audio cable.



Projector Terminal	Connection Cable	Video Device Terminal
③ COMPUTER IN 1*2 or ④ COMPUTER IN 2	Component video cable  15-pin Mini D-Sub	Component Video Out terminals 
⑤ AUDIO IN 1*3 or ⑥ AUDIO IN 2	Audio cable  Stereo mini jack	Audio Out terminals 

*2 An XJ-F Series model has a COMPUTER IN terminal only.

*3 An XJ-F Series model has an AUDIO IN terminal only.

Composite Video Connection

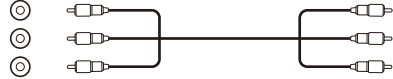
Video device composite video output terminals are grouped as a set of three: video (yellow) and audio (white and red). Use a video and audio RCA cable to connect to the like-colored terminals of the projector.

Projector Terminal	Connection Cable	Video Device Terminal
⑦ VIDEO, AUDIO IN R/L	RCA audio video cable  RCA jacks	Composite Video Out/ Audio Out terminals 



Note

- The relationship between the image output terminal and audio output terminal can be changed as required. Note that the combinations shown in the table are initial default settings. For details, see "Relationship Between Image Input and Audio Input" (page 41).

Outputting Audio from the Projector to Another Device

You can output audio to an amp speaker or another device instead of using the projector’s built-in speaker.

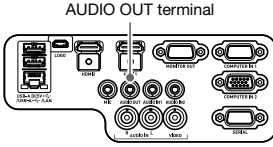

XJ-UT Series

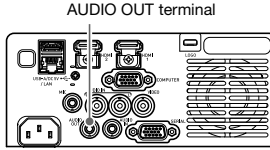

XJ-F Series

Under initial projector default settings, audio is output from the projector’s built-in speaker. To output audio using another device, connect as shown below and then change the Setup Menu “Option Settings 2 → Audio Out” setting to “Line”.

Projector Terminal	Connection Cable	Other Device Terminal
AUDIO OUT	<p>Audio cable</p> <p>Stereo mini jack</p>	Audio In terminal



Note

- You can also configure settings so that audio input to the projector continues to be output from the AUDIO OUT terminal even while the projector is in standby (projector turned off, but being supplied with power) (XJ-UT Series only). See “Option Settings 2 → Standby RGB/Audio” (page 61).

Connecting a Microphone (XJ-UT Series, XJ-F21XN, XJ-F211WN)

Connecting a microphone to the projector's MIC terminal makes it possible to output microphone input through the projector's speaker.

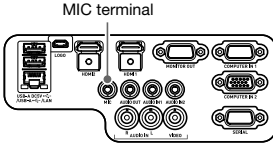

XJ-UT Series

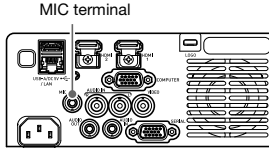

XJ-F21XN, XJ-F211WN

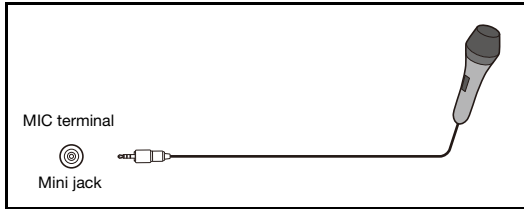

- Use this terminal to connect a dynamic microphone.
- Plug-in power type microphones are not supported.

Connecting to a Network with a LAN Cable (Network Models Only)

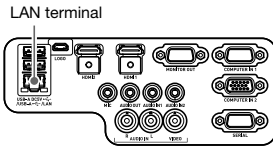

If you have a network model projector, you can use a LAN cable to connect it to the network hub or another device of an existing network. Use a 100BASE-TX or 10BASE-T standard Category 5 or higher LAN cable for connection. Use of a shielded (STP) cable is recommended.

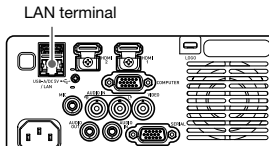

XJ-UT312WN, XJ-UT352WN

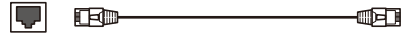

XJ-F21XN, XJ-F211WN

Projector Terminal	Connection Cable	Other Device Terminal
LAN	LAN cable  RJ-45	LAN terminal (RJ-45) 

After connecting the projector to a network, you will be able to project the screen of any computer on the network. You also will be able to control the projector and configure its settings from a computer. For details, see the separate "Network Function Guide".

Connecting a Wireless Adapter (Network Models Only)

Connecting the projector's wireless adapter* enables wireless connection to a computer or a smart device, or to an existing wireless access point.

* The YW-41 wireless adapter may have been provided with your projector or may be available separately. See "Unpacking" (page 20).

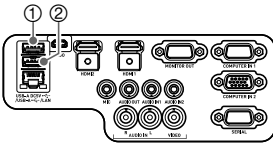

XJ-UT312WN, XJ-UT352WN

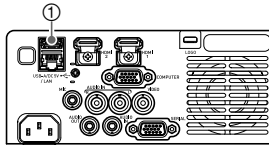

XJ-F211XN, XJ-F211WN

■ XJ-UT312WN, XJ-UT352WN

Plug into the ① USB-A/DC 5V port or the ② USB-A port.

■ XJ-F211XN, XJ-F211WN

Plug into the ① USB-A/DC 5V port.

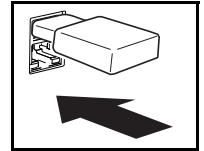

For details about operations to use for wireless connection of the projector to a computer or a wireless access point, and about operations after a connection is established, refer to the separate "Network Function Guide".

LOGO Terminal (Firmware Updates, User Logo Transfers)

You can update the projector's firmware (software in the projector's flash ROM) using a computer connected to the projector's LOGO terminal. You can also transfer user logo images from the computer to the projector.

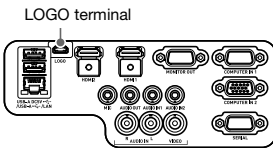

XJ-UT Series

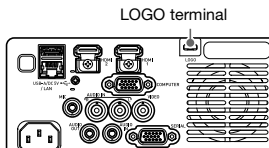

XJ-F Series

Projector Terminal	Connection Cable	Computer Terminal
LOGO	<p>USB cable</p> <p>USB Micro B</p>	USB port

For information about operations after connection, refer to the documentation below, which is available from the CASIO website.

Firmware updates : Projector Firmware Update Guide

User logo transfers: User Logo Transfer Guide

Connecting a Scientific Calculator (Network Models Only)

After connecting a scientific calculator to the projector, you will be able to project the calculator's screen image. For information about connectable calculators, go to the CASIO website.

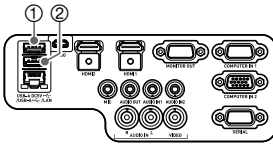

XJ-UT312WN, XJ-UT352WN

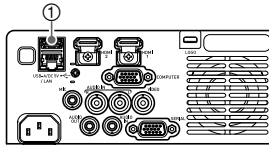

XJ-F21XN, XJ-F211WN

Projector Terminal	Connection Cable	Calculator Terminal
① USB-A/DC 5V or ② USB-A	USB cable USB Type A Type B mini	USB port



Important!

- To project the screen image of a scientific calculator, select “CASIO USB Tool” as the projector’s input source. For information about how to do this, see “Changing the Input Source Manually” (page 41).
- If you experience problems after connecting a scientific calculator to the projector, disconnect the USB cable from both devices. Next, use the cable to re-connect them.
- For information about scientific calculator operation, refer to its user documentation.

SERIAL Terminal (Projector Control Using Commands)

You can control the projector by sending it commands from a device (computer, other RS-232C controller device) connected to the projector’s SERIAL terminal.

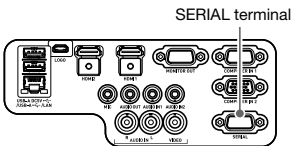

XJ-UT Series

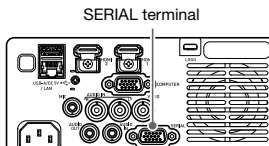

XJ-F Series

Projector Terminal	Connection Cable	Other Device Terminal
SERIAL	Serial cable (cross) D-Sub9 pin	RS-232C terminal

For details about control commands, see “Projector RS-232C Control” (page 80).

USB Power

You can use the projector to supply USB power to another device. See “Supplying USB Power to Another Device” (page 72).

Cover Included with the YW-41 Wireless Adapter

The YW-41* wireless adapter comes with an anti-theft cover that can be installed on an XJ-F Series model.

* The YW-41 wireless adapter may have been provided with your projector or may be available separately. See “Unpacking” (page 20).



Caution

Keep the wireless adapter and the wireless adapter cover out of the reach of small children. Accidental swallowing of the adapter can interfere with proper breathing and create a life-threatening situation.

XJ-F Series

After plugging the wireless adapter into the projector, install the wireless adapter cover as required. Cover the wireless adapter with the wireless adapter cover and then secure it with the screw.

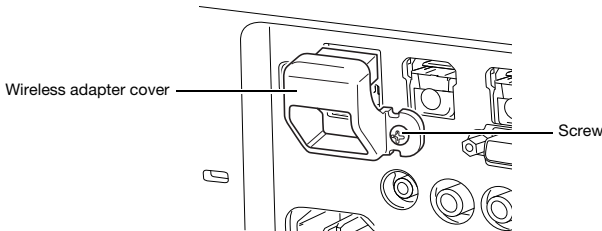

XJ-UT Series

The cover that comes with the wireless adapter cannot be installed on an XJ-UT Series model. To protect against theft of the wireless adapter while it is connected to the projector, use the cable cover (page 35) that comes with the projector.

Attaching and Removing the Cable Cover (XJ-UT Series)

Before attaching or removing the cable cover, turn off the projector and unplug its power plug from the power outlet. After turning off the projector, wait for a while to allow it to cool.

To attach the cable cover

1. Turn the projector over and insert the cable cover hook into the hole provided on the projector (Figure 1).
2. Rotate the cable cover in the direction indicated by the arrow in Figure 2 to attach it to the projector.
3. Aligning the cable cover screw with the screw hole on the projector (Figure 3), use a Phillips head screw driver to tighten the screw (Figure 4).

To remove the cable cover

1. Use a Phillips head screw driver to loosen the cable cover screw until it disengages from the projector (without detaching it from the cover).
2. Remove the screw side of the cable cover from the projector and then unhook the cover hook from the projector.

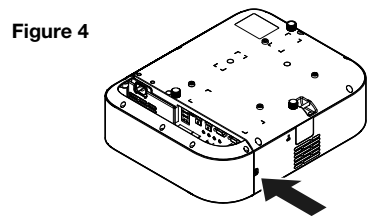
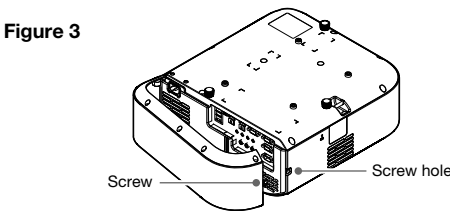
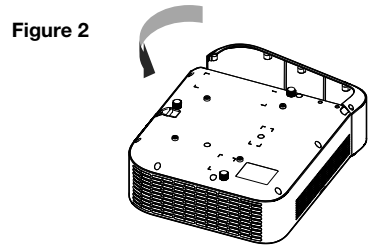
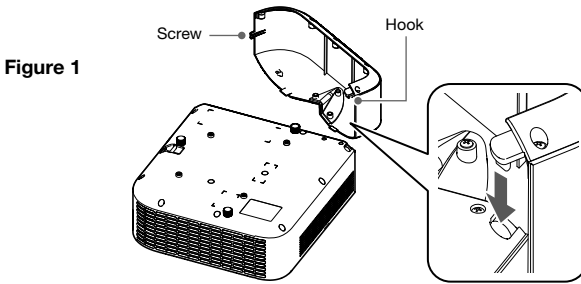

Remote Controller

Projector operations are performed using the remote controller that comes with it. Point the remote controller signal emitter at one of the signal receivers on the projector as you perform remote controller key operations. The maximum range of the remote controller signal is approximately 5 meters (16.4 feet) (between signal emitter and receiver).

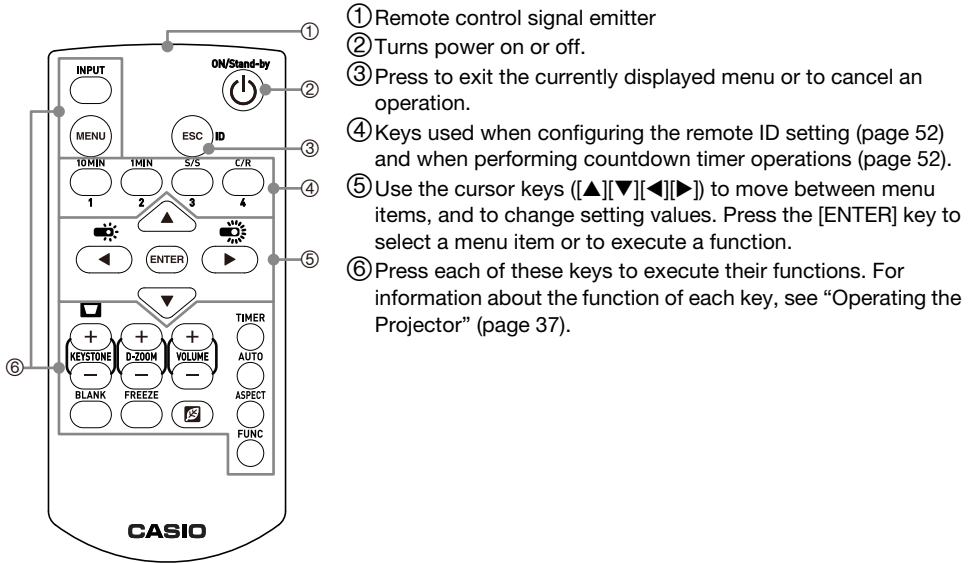

Important!

- To avoid running down the batteries, store the remote control unit so its keys are not pressed inadvertently.



Note

- Specifications are subject to change without notice.

Operating the Projector

Unless specifically noted otherwise, the operations in this section are performed using the remote controller. If both the projector and the remote controller have the same key, either one can be used to perform the corresponding operation.

Turning the Projector On or Off

This section explains how to turn projector power on and off, and provides information about power-related settings.

For information about the general procedure that is required before turning on the projector, see “Operation Flow to Projection” (page 20).

To turn on the projector

- 1. Connect the provided power cord to the projector’s AC terminal and plug in to a power outlet.**
 - Wait until the POWER/STANDBY indicator lights red.
- 2. Press the [⏻] key to turn on the projector.**
 - This will cause the POWER/STANDBY indicator (green) to flash for a few seconds, and then stop flashing and remain lit.
 - The projector will perform an auto input search operation at this time. If it finds an input signal, it will start projecting its image. For details, see “Using Auto Input Search” (page 39).



Note

- For details about what indicators show, see “Normal Operation Indicators” (page 66).

To turn off the projector

- 1. Press the [⏻] key.**
 - This will cause the POWER/STANDBY indicator (red) to flash for a few seconds, and then stop flashing and remain lit.
- 2. Unplug the power cord from the power outlet and then disconnect it from the projector.**

Direct Power On

When “On” is selected for the “Option Settings 1 → Direct Power On” setting (page 60), the projector will turn on automatically whenever you plug its power cord into a power outlet. (Initial default setting: “Off”).

Auto Power Off

Under initial default settings, Auto Power Off is enabled and will automatically turn off the projector after about 10 minutes of non-operation (no key operation or input signal). You can use “Option Settings 1 → Auto Power Off” (page 60) to change the Auto Power Off trigger time or to disable Auto Power Off.

Auto Projection Off

Auto Projection Off automatically turns off the projection light whenever the input signal from an input source is lost during projection. The light will turn back on if the input signal from the original input source is restored within 20 minutes after the light is turned off. This function comes in handy when multiple computers are alternately connect to the projector.

For details, see “Using Auto Projection Off” (page 43).

Selecting an Input Source (INPUT)

Your projector can project images from input sources described below.

Input Source	Description
Computer (1/2)*1	Projects the RGB signal of a computer or the component video signal of a video device connected to a projector COMPUTER IN (1/2) terminal.*1
Video	Projects the composite video signal of a video device connected to the projector's VIDEO terminal.
HDMI (1/2)*1	Projects the HDMI(PC) signal of a computer or HDMI(DTV) of a video device connected to a projector HDMI(1/2) terminal.*1
CASIO USB Tool*2	Projects the screen image of a scientific calculator (page 33).
Network*2	Projects the image a computer connected to the projector over a network. For details, see the separate “Network Function Guide”.
Templates	Projects the image of one of the projector's built-in templates*3 (page 49).

*1 The number of inputs (input terminals) depends on your projector model.

*2 Network models only

*3 With a network model, you can add template images. For details, see the separate “Network Function Guide”.

Resolution

Depending on the projector model, its projection resolution will be fixed at XGA (1024 × 768 pixels) or WXGA (1280 × 800 pixels). Images may appear coarse, text and other figures may be difficult to read or a moire pattern may appear when the input signal from a computer does not match the projector's projection resolution. If this happens, try doing the following.

- Change the computer's output resolution setting so it matches the projector's projection resolution. For information about the projection resolution of your projector, see “Specifications” (page 83). See the user documentation that comes with your computer for details about changing its settings.
- Change the “Aspect Ratio” setting to “True” (Applies only to models that support WXGA projection resolution). With the “True” setting, the projector projects the input signal at its actual size (1 input source dot equal to one projector output pixel dot). For information about configuring the Aspect Ratio setting, see “Change the aspect ratio of the projected image (ASPECT)” (page 46).

Using Auto Input Search

After the projector is turned on, it starts an auto input search operation. It sequentially checks its image input terminals and, when it finds an input signal, it automatically starts projection of the signal's image.



Note

- Auto input search is not performed if “Test Pattern” is selected for “Screen Settings → No Signal Screen” (page 58).

Triggering an Auto Input Search Operation Manually

1. Hold down the [INPUT] key until the message “Searching...” appears on the display.

- While an auto input search operation is in progress, the name of the input source the projector is currently checking along with the message “Searching...” will be shown on the display.
- When an input signal is detected, the auto input search operation stops, the “Searching...” message disappears, and the input signal's image starts to be projected. To trigger an auto input search operation manually, hold down the [INPUT] key until the “Searching...” message appears on the display.
- To stop an ongoing auto input search operation, press the [INPUT] or [ESC] key.
- If the projector is unable to detect an input signal it repeats the detect operation a second time in the sequence shown under “Auto Input Search Sequence” (page 40). If the projector is ultimately unable to detect an input signal, the message “No signal input” will appear.

Auto Input Search Following Power On

When the projector is turned on, it will perform an auto input search operation when either of the conditions described below exists.

- When the input source being projected the last time the projector was turned off was CASIO USB Tool, Network, or Templates.
- When the input source being projected the last time the projector was turned off was not one of those above and there is no input signal from the last projected input source. If there is an input signal from the last input source, projection of that input source will resume.



Note

- The following input sources are not detected immediate after the projector is turned on: CASIO USB Tool, Network, Templates.

Auto Input Search Sequence

Auto input search is performed in a particular sequence, depending on the projector series.

XJ-UT Series

■ XJ-UT352W



■ XJ-UT352WN

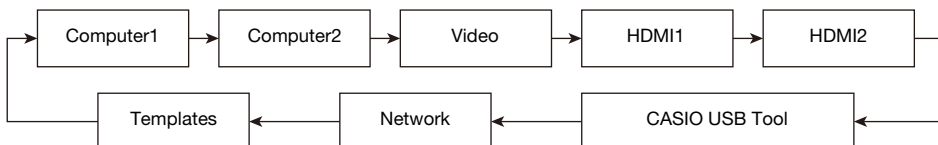

■ XJ-UT312WN

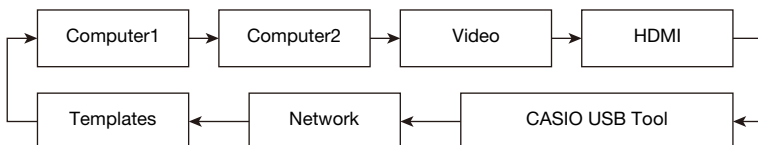

XJ-F Series

■ XJ-F11X, XJ-F101W

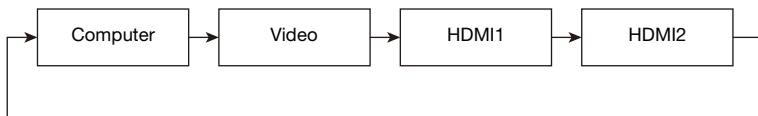

■ XJ-F21XN, XJ-F211WN

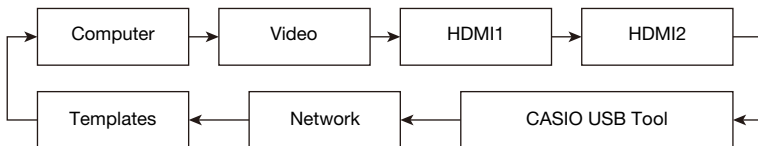

Note

- When the projector is turned on, it automatically performs an auto input search operation starting from the input source that was selected when power was last turned off.
- You can configure settings to control whether or not an auto input search operation is triggered by turning on the projector or by holding down the [INPUT] key. See “Input Settings → Auto Input Search” (page 59).

Changing the Input Source Manually

Use the procedure below to change the input source manually.

1. Press the [INPUT] key to display the input menu.
2. Use the [INPUT], [▲], and [▼] keys to select the name of the input source you want, and then press the [ENTER] key.
 - Note that even if you do not press the [ENTER] key, the projector will automatically switch to the input source you selected after about three seconds.
 - The name of the input source you selected will appear in the upper right corner of the projection screen for a few seconds.
 - The message “No signal input” will appear if an input source cannot be found.

Relationship Between Image Input and Audio Input

Selecting an input source causes the projector to output the image from the image input terminal that corresponds to the input source, and the audio from the audio input terminal. The relationship between input sources and terminals is shown in the table below.

Input Source	Image Input Terminal (Fixed)	Audio Input Terminal (Initial Default)
Computer (1/2)*1	COMPUTER IN (1/2)*1	AUDIO IN (1/2)*1
Video	VIDEO	AUDIO IN R/L
HDMI (1/2)*1	HDMI (1/2)*1	HDMI (1/2)*1
CASIO USB Tool*2	USB-A (1/2)*1	AUDIO IN 1 (May be AUDIO IN, depending on the model.)
Network*2	USB-A (1/2)*1*3 or LAN	USB-A (1/2)*1*3 or LAN (Network AUDIO)
Templates	(Projects a projector built-in image.)	AUDIO IN 1 (May be AUDIO IN, depending on the model.)

*1 The number of inputs (input terminals) depends on your projector model.

*2 Network models only

*3 YW-41 wireless adapter connection is required. See “Connecting a Wireless Adapter” (page 32).

Changing the Audio Input

Though the image input terminal of each input source is fixed, audio input terminal assignments can be changed by you as desired.

To do this:	Perform this operation:
Change the audio input for a particular input source	<ol style="list-style-type: none">1. Press the [MENU] key to display the Setup Menu.2. Select "Option Settings 2 → Audio Input" and then press the [ENTER] key.3. Use the [▲] and [▼] keys to select the input source whose audio input setting you want to change.4. Use the [◀] and [▶] keys to select the audio input you want to assign to the selected input source.5. Repeat steps 3 and 4 as required.6. After the settings are the way you want, press the [MENU] key to exit the Setup Menu.
Return audio inputs for all the input sources to their initial default settings	<p>On the Setup Menu, perform the following operation: Option Settings 2 → Initialize Projector Options 2.</p> <ul style="list-style-type: none">● Note that this returns all items included on the "Option Settings 2" menu (not just audio input settings) to their initial default settings.

Using Auto Projection Off

Auto Projection Off automatically turns off the projection light approximately 10 seconds*1 after the input signal from an input source is lost during projection. The light will turn back on if the input signal from the original input source is restored within 20 minutes*2 after the light is turned off.

*1 A message first appears about five seconds after the input signal is lost, and then the light is turned off five seconds after that.

*2 The projector automatically turns off if the input source is not restored within 20 minutes.

Auto Projection Off Operation Example

The example below shows an image of how Auto Projection Off works when multiple users alternately connect to the projector.

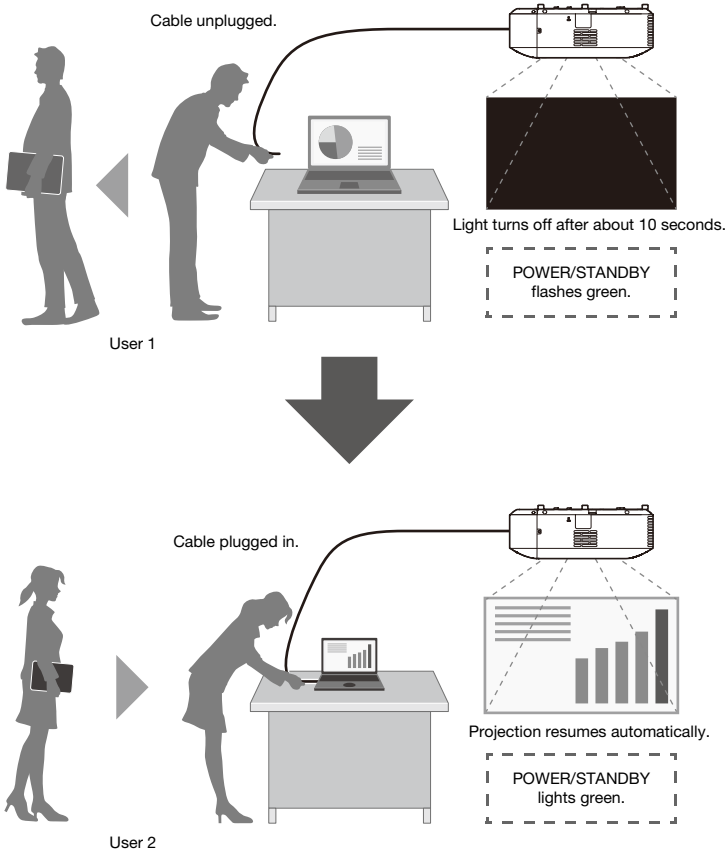

Though the above example shows a cable connection, the same also applies to wireless LAN connection.

Enabling and Disabling Auto Projection Off

Auto Projection Off is disabled (Off) under initial projector default settings. To enable Auto Projection Off, change “Screen Settings → Auto Projection Off” (page 58) on the Setup Menu to “Enable”.

Auto Projection Off Projection Light Control

Projection Light Off Conditions

If the image input signal from the input source device to the projector is lost for some reason while projection is being performed, the no signal screen (page 58) or the network standby screen* appears first. If no operation is performed for about 10 seconds, the projection light turns off and audio becomes muted.

The following message will be displayed for about five seconds before the light turns off: “Auto Projection Off is enabled. The projector will stop projecting.”

Auto Projection Off operation is not affected by whether audio is being input.

* The network standby screen appears when the source setting is “Network”. It indicates that the projector is standing by for a network connection (wired LAN or wireless LAN). For details about projection using a network connection, refer to the separate “Network Function Guide”.

Auto Projection Off is not triggered while any one of the following conditions exists.

- If there has been no projection from any input source since the projector was turned on.
- While a template (page 49), the countdown timer (page 52), or a test pattern (page 51) is being projected.
- While an auto input search operation is in progress (page 39).

Projection Light Restoration Conditions

The projection light will turn back on when the currently selected input source resumes signal input (or, in the case of the “Network” input source, a network connection starts projection), or when a key operation is performed on the projector or its remote controller.

Auto Power Off Following Projection Light Off

If the “Auto Projection Off” setting is “Enable”, the Auto Power Off trigger time is fixed at 20 minutes after the projection light is turned off. This is true regardless of the current Auto Power Off setting (page 60).

Projector Operation While the Projection Light is Off

- The POWER/STANDBY indicator (green) flashes slowly while the projection light is turned off by the Projection Light Off function.
- Auto Power Off will be triggered if no projector key operation is performed for approximately 20 minutes after the projection light turns off.

Basic Image and Audio Operations During Projection

To end the operations below, press the [ESC] key.

To do this:	Perform this operation:
■ XJ-UT Series Correct vertical and horizontal keystoneing manually (KEYSTONE)	<ol style="list-style-type: none"> While there is no menu or dialog box displayed on the projection screen, press the projector [▲] or [▼] key, or the remote controller [KEYSTONE +] or [KEYSTONE -] key. Use the [▲] and [▼] keys to correct vertical keystoneing, and the [◀] and [▶] keys to correct horizontal keystoneing. <ul style="list-style-type: none"> Both vertical and horizontal keystoneing can be corrected within a range of $\pm 5^\circ$.
■ XJ-F Series Correct vertical keystoneing manually (KEYSTONE)	<p>Using Projector Keys</p> <ol style="list-style-type: none"> After confirming that a menu or dialog box is not on the projection screen, press the projector's [▲] or [▼] key. Use the [▲] and [▼] keys to correct vertical keystoneing. <p>Using Remote Controller Keys</p> <ol style="list-style-type: none"> Use the [KEYSTONE +] and [KEYSTONE -] keys to correct vertical keystoneing. <p> Note</p> <ul style="list-style-type: none"> You can correct this image within a range of $\pm 30^\circ$. If "On" is selected for "Option Settings 1 → Auto Keystone Correction" (page 59), the projector will detect its vertical tilt and perform keystone correction automatically.
Zoom an image (D-ZOOM)	<ol style="list-style-type: none"> Press the [D-ZOOM +] key to enlarge at the center of the projected image. To zoom in on the center of the projected image more, press the [D-ZOOM +] key again. To zoom out, press the [D-ZOOM -] key. While an image is zoomed, use the [▲], [▼], [◀], and [▶] keys to scroll the view to other parts of the image.
Momentarily blank the image and mute the audio (BLANK)	<ol style="list-style-type: none"> Press the [BLANK] key. <ul style="list-style-type: none"> This cuts off the image and audio from the input source, and projects the screen specified by the Setup Menu "Screen Settings → Blank Screen" setting (page 58). If "Projection Off" is specified for the "Blank Screen" setting, the projection light will turn off at this time. To restore the image and audio, press the [BLANK], [ESC], or [⏻] key. <ul style="list-style-type: none"> Note that the [⏻] key can be used only when "Projection Off" is selected for the "Blank Screen" setting.
Freeze an image (FREEZE)	<ol style="list-style-type: none"> Press the [FREEZE] key. <ul style="list-style-type: none"> This freezes the current input source image. To return to the real-time input source image, press the [FREEZE] key again or press the [ESC] key.
Auto adjust an image (AUTO)	<ol style="list-style-type: none"> Press the [AUTO] key. <ul style="list-style-type: none"> This automatically adjusts the frequency and phase in accordance with the input signal, which can reduce flickering and other projected image problems. This operation is supported while the input source is Computer (RGB).

To do this:	Perform this operation:								
Change the aspect ratio of the projected image (ASPECT)	<ol style="list-style-type: none"> Press the [ASPECT] key. <ul style="list-style-type: none"> Each press of the [ASPECT] key cycles between the aspect ratio settings as shown below. For the meaning of each setting, see “Aspect Ratio Setting Details” (page 47). <p>● Input source: RGB, HDMI(PC), CASIO USB Tool, Network or Templates</p> <table border="1" data-bbox="351 209 1012 272"> <tr> <td>WXGA models</td> <td>“Normal” → “Full” → “16:9” → “4:3” → “True”</td> </tr> <tr> <td>XGA models</td> <td>“Normal” → “Full” → “16:9” → “16:10”</td> </tr> </table> <p>● Input source: Video, Component or HDMI(DTV)</p> <table border="1" data-bbox="351 320 1012 384"> <tr> <td>WXGA models</td> <td>“Normal” → “16:9” → “16:10” → “4:3” → “Letter Box”</td> </tr> <tr> <td>XGA models</td> <td>“Normal” → “16:9” → “16:10” → “4:3”</td> </tr> </table> <p> Important!</p> <ul style="list-style-type: none"> Note that enlarging or reducing the size of an image using the [ASPECT] key for commercial purposes or public presentation may infringe on the legally protected copyright of the copyright holder of the original material. 	WXGA models	“Normal” → “Full” → “16:9” → “4:3” → “True”	XGA models	“Normal” → “Full” → “16:9” → “16:10”	WXGA models	“Normal” → “16:9” → “16:10” → “4:3” → “Letter Box”	XGA models	“Normal” → “16:9” → “16:10” → “4:3”
WXGA models	“Normal” → “Full” → “16:9” → “4:3” → “True”								
XGA models	“Normal” → “Full” → “16:9” → “16:10”								
WXGA models	“Normal” → “16:9” → “16:10” → “4:3” → “Letter Box”								
XGA models	“Normal” → “16:9” → “16:10” → “4:3”								
Change the color mode (FUNC)	<ol style="list-style-type: none"> Press the [FUNC] key. On the menu that appears, select “Color Mode” and then press the [ENTER] key. Use the [▲] and [▼] keys to move the highlighting to the color mode you want to select, and then press the [ENTER] key. <ul style="list-style-type: none"> For details on what each color mode does, see “Image Adjustment 1 → Color Mode” (page 56). The color mode cannot be selected when “Off” is selected for the “Light Control” setting (page 48). 								
Adjust the volume level (VOLUME)	<ol style="list-style-type: none"> Press the [VOLUME +] or [VOLUME -] key to display the “Volume” dialog box. Press the [VOLUME +] key to increase the volume, or the [VOLUME -] key to lower the volume. 								
Mute the audio (VOLUME)	<ol style="list-style-type: none"> Press the [VOLUME +] or [VOLUME -] key to display the “Volume” dialog box. Press the [ENTER] key to mute the audio. To restore the audio, press the [VOLUME +] or [VOLUME -] key. 								

Aspect Ratio Setting Details

Normal	Projects at the projector's maximum possible size while maintaining the input signal aspect ratio.
Full	Projects at the projector's maximum possible size by enlarging or reducing the input signal.
16:9	This setting specifies a 16:9 aspect ratio, which is the same as a movie screen, high-definition TV, etc. Using this setting when the input signal is a 16:9 image that has been squeezed to a 4:3 image causes the image to be displayed with its normal 16:9 aspect ratio.
16:10	This setting specifies a 16:10 aspect ratio. Use this setting to adjust the image for projection onto a 16:10 aspect ratio screen.
4:3	Regardless of the input signal aspect ratio, the image is always resized to an aspect ratio of 4:3 for projection.
True	Projects each input source dot as a projector output pixel dot. If the input signal resolution exceeds the projector's output resolution, the excess is cut off. When projecting while "True" is selected as the aspect ratio setting for an RGB signal with a resolution that is less than SVGA, the image is enlarged to SVGA and projected.
Letter Box	This will resize the image horizontally to 1280 dots and project 800 vertical dots of the center of the image, maintaining the aspect ratio of the input signal.

For details about how the aspect ratio setting affects the projected image, see "Aspect Ratio Setting and Projection Image" (page 77).

Flipping the Projected Image Horizontally (Mirror Mode)

You can use the procedure below to enter the Mirror Mode, which flips the projected image horizontally.

- 1. While projection from an input source is being performed, press the [INPUT] key.**
 - This displays the input menu. The input source that is currently being projected will be selected on the menu.
- 2. Press the [◀] or [▶] key to enter the Mirror Mode.**
 - This exits the input menu and flips the image.
 - A Mirror Mode icon will be in the upper right corner of the projection screen while the projector is in the Mirror Mode.
- 3. To exit the Mirror Mode, press the [ESC] key.**
 - Pressing any key other than [BLANK], [FREEZE], [D-ZOOM +], [D-ZOOM -], [VOLUME +], or [VOLUME -] will also exit the Mirror Mode.



Note

- Operation of the keys below is enabled while in the Mirror Mode.
[⏻], [BLANK], [FREEZE], [D-ZOOM +], [D-ZOOM -], [VOLUME +], [VOLUME -]
The [VOLUME +] and [VOLUME -] keys can be used to adjust the volume level, but not to mute the audio.

Light Control

Light Control lets you adjust the light being output (light source brightness) by the projector. When “On” is selected for “Option Settings 1 → Light Control → Light Control” (page 60) on the Setup Menu (initial default setting), light output can be adjusted to one of seven levels.

To do this:	Perform this operation:
Adjust light output	<ol style="list-style-type: none">1. While there is no menu or dialog box displayed on the projection screen, press the [◀] or [▶] key.<ul style="list-style-type: none">● This displays the current light output level as a value from 1 to 7.2. Use the [◀] and [▶] key to adjust light output.3. To end the operation, press the [ESC] key.
Have light output adjusted automatically	<ol style="list-style-type: none">1. Press the [MENU] key to display the Setup Menu.2. Perform the following menu operation: Option Settings 1 → Light Control → Light Sensor.3. Use the [◀] and [▶] keys to change “Light Sensor” to “On”.4. After the settings are the way you want, press the [MENU] key to exit the Setup Menu.

Light Control Off Mode (Maximum Brightness)

If you want the projection light to be at maximum brightness, change “Option Settings 1 → Light Control → Light Control” (page 60) on the Setup Menu to “Off”, and “Light Control Off Mode” (page 56) to “Bright”.



Note

- Selecting “Off” for “Light Control” disables light output adjustment and the brightness sensor.

Digital Screen Shift

You can use the procedures in this section to reduce the size of the projected image while maintaining its aspect ratio and to shift the projection image vertically or horizontally, without physically moving the projector.

To do this:	Perform this operation:
Adjust the projection image size and position	<ol style="list-style-type: none">1. Press the [MENU] key to display the setup menu.2. Select the following in sequence, and then press the [ENTER] key: “Screen Settings”, “Digital Screen Shift”, “Reposition Digital Screen Shift”.<ul style="list-style-type: none">● This displays the “Digital Screen Shift” dialog box.3. Use the [D-ZOOM -] and [D-ZOOM +] keys to adjust the size of the projected image within the range of 84% to 100%.<ul style="list-style-type: none">● If a zoom factor that is less than 100% is specified, you can also perform the step 4 and 5 below to reposition the projection image. If 100% is specified, jump to step 5 of this procedure.4. Use the [▲] and [▼] keys to move the projection image vertically, and the [◀] and [▶] keys to move it horizontally.5. When everything is the way you want, press the [ESC] key to close the dialog box. Next press [MENU] to close the setup menu.
Return the projection image size and position to their initial defaults	<ol style="list-style-type: none">1. Press the [MENU] key to display the setup menu.2. Select the following in sequence, and then press the [ENTER] key: “Screen Settings”, “Digital Screen Shift”, “Restore Default Digital Screen Shift”.3. Press the [▲] key, select “Yes”, and then press the [ENTER] key.

Projecting a Template

Your projector comes with nine built-in templates that let you project horizontal lines, gridlines, and other images onto a whiteboard or blackboard.

- With a network model, you can increase the number of available templates by transferring template images from a computer to projector memory. For details, see the separate “Network Function Guide”.

To project a template

- 1. Press the [INPUT] key to display the input menu.**
- 2. Use the [INPUT], [▲], and [▼] keys to select “Templates”, and then press the [ENTER] key.**
 - This projects the template that was previously last projected.
- 3. Use the [◀] and [▶] keys to change to another template type.**
 - Use the procedure under “To change the template type (XJ-UT352W, XJ-F11X, XJ-F101W)” (page 50) to change to another template.
 - With a network model, you can also adjust projection brightness (page 56).

4. To stop template projection, change to another input source or turn off the projector.

- If you turn off the projector while a template is being projected, the same template will be projected again when you turn power back on.



Note

- Note that an image input signal being input to the projector cannot be projected while a template is being projected.
- Auto Projection Off (page 43) and Auto Power Off (page 60) are both disabled while a template is being projected.
- With an XJ-UT352W, XJ-F11X, and XJ-F101W model, the following settings cannot be adjusted while a template is being projected: “Brightness” (page 56), “Contrast” (page 56).

To change the template type (XJ-UT352W, XJ-F11X, XJ-F101W)

1. While a template is being projected, press the [FUNC] key and then the [ENTER] key.
 - This displays the “Template Type” menu.
2. Use the [▲] and [▼] keys to select the template you want to project, and then press the [ENTER] key.

To change the template type (Network Models)

1. While a template is being projected, press the [FUNC] key and then the [ENTER] key.
 - This displays the template selection screen.
2. Use the cursor keys to move the focus to the template you want to project.
 - To project a template that is located in a folder that is different from the currently displayed folder, perform the steps below.
 - (1) While the focus is located at any template on the far left, press the [◀] key.
 - This moves the focus to the folder selection area.
 - (2) Use the [▲] and [▼] keys to move the focus to the folder that contains the template you want to project.
 - (3) Press the [▶] key.
 - This moves the focus back to the template selection area.
 - (4) Use the cursor keys to move the focus to the template you want to project.
3. Press the [ENTER] key.



Note

- Under network model initial default settings, only the top folder contains templates. All of the other folders are empty. For information about the procedure to add a template, refer to the separate “Network Function Guide”.

Test Pattern Projection

You can use the operations below to have the projector project a “No Signal Screen” (page 58) or a “Blank Screen” (page 58) as a test pattern. Use the test pattern when adjusting the parameters of the projection screen (position, size, keystone correction, focus, aspect ratio, Digital Screen Shift, etc.) The test pattern also comes in handy when making fine adjustments after mounting the projector on a wall.

To do this:	Perform this operation:
Specify use of the No Signal Screen for test pattern projection	<ol style="list-style-type: none"> 1. Press the [MENU] key to display the setup menu. 2. Select “Screen Settings”, “No Signal Screen”, and then use the [◀] and [▶] keys to select “Test Pattern”. 3. Press the [MENU] key to close the setup menu.
Specify use of the Blank Screen for test pattern projection	<ol style="list-style-type: none"> 1. Press the [MENU] key to display the setup menu. 2. Select “Screen Settings”, “Blank Screen”, and then use the [◀] and [▶] keys to select “Test Pattern”. 3. Press the [MENU] key to close the setup menu.
Project the Test Pattern	<ul style="list-style-type: none"> ● If settings are configured to project the test pattern when there is no signal, use the [INPUT] key to select an input source that is not sending an input signal to the projector. ● If settings are configured for output of the test pattern when the image is blanked, press the [BLANK] key.



Important!

- Auto Power Off (page 60), Auto Projection Off (page 43), and Auto Input Search (page 59) are disabled while a test pattern is being projected.

Control Panel Lock

Control panel lock disables (locks) all of the projectors keys, except for the [⏻] key. This limits projector operation to the remote controller, which protects against inadvertent mis-operation.

To do this:	Perform this operation:
Lock the control panel	<ol style="list-style-type: none"> 1. Press the [MENU] key to display the setup menu. 2. Select “Option Settings 2”, “Control Panel Lock”. 3. Use the [◀] key to select “On”. When the confirmation dialog box appears, press the [ENTER] key. <ul style="list-style-type: none"> ● This disables (locks) all projector keys except for the [⏻] key. 4. After you are finished, press the [MENU] key to exit the setup menu.
Unlock the control panel	<p>Perform either of the following operations.</p> <ul style="list-style-type: none"> ● While there is no menu or dialog box displayed on the projection screen, hold down the projector’s [▼] key until the message “Control panel was unlocked.” appears. ● To use the remote controller to unlock the control panel, perform the procedure under “Lock the control panel” above. In step 3, press the [▶] key of the remote controller to select “Off” and then press the [MENU] key.

Configuring Remote Control ID and Projector ID Settings

The remote control ID and projector ID are numbers from 1 to 4. If the two IDs match, you will be able to perform all projector operations from the remote controller. This function helps to avoid remote control conflicts when there are multiple projectors (up to four) in the same area.

The initial factory default setting of both the remote control ID and projector ID is “All”, which means that the remote controller signal can be sent and received regardless of the ID of the sending/receiving device.

The “Specify a remote control ID” operation in the table below can be performed on the remote control unit only. This operation can be performed even if the projector is turned off. For the other operations, first start image projection operation and then perform the operation.

To do this:	Perform this operation:
Specify a remote control ID	While holding down the remote controller [ESC] key, press one of the keys below. <ul style="list-style-type: none">● [1], [2], [3], or [4]: Sets the number of the key you press as the remote control ID.● [MENU]: Changes the remote control ID to “All”.
Specify a projector ID	<ol style="list-style-type: none">1. Press the [MENU] key to display the setup menu.2. Select “Option Settings 1”, “Projector ID”, and then press the [ENTER] key.3. Use the [▲] and [▼] keys to select a number from 1 to 4 or select “All”, and then press the [ENTER] key.
Check the current remote control ID and projector ID settings	While holding down the remote controller [ESC] key, press the [INPUT] key. This will project the remote control ID and projector ID for about 10 seconds. The remote control ID and projector ID shown by this operation may not match each other.

Using the Countdown Timer (TIMER)

The countdown timer displays a large timer in the center of the projected image.



Important!

- To use the countdown timer, change “Option Settings 2 → Timer Type” (page 61) on the Setup Menu to “Countdown”. (The projector’s initial default setting is “Countdown”).
- The following functions are disabled while the countdown timer is being projected: Auto Projection Off (page 43), Auto Power Off (page 60).

Showing and Hiding the Countdown Timer

- 1. To show the countdown timer, press the [TIMER] key.**
 - This will display the countdown timer on top of the current projected image.
- 2. To hide the countdown timer, press the [TIMER] key again.**

Countdown Timer and Remote Controller Keys

The four buttons underneath the countdown timer correspond to remote controller buttons as shown below.

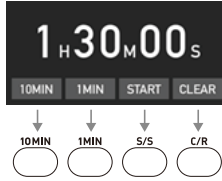

Countdown Timer Operations

The operations below can be performed while the countdown timer is shown.

To do this:	Perform this operation:
Specify the countdown start time	<ol style="list-style-type: none"> While the countdown is stopped, press the [FUNC] key. <ul style="list-style-type: none"> This displays the countdown time setting screen. Use the [◀] and [▶] keys to move the cursor to the digit you want to change. Use the [▲] and [▼] keys to change the value at the current cursor position. <ul style="list-style-type: none"> You can set a countdown start time in the range of 0H00M00S to 9H59M59S. To apply the countdown time setting and exit the setting screen, press the [ENTER] key. <ul style="list-style-type: none"> To discard your changes and exit the setting screen, press the [ESC] key.
Add one minute or 10 minutes to the countdown time	While the countdown is stopped, press the [1MIN] key to add one minute, or the [10MIN] key to add 10 minutes.
Start the countdown	While the countdown is stopped, press the [S/S] key.
Pause the countdown	While a countdown is in progress, press the [S/S] key.
Resume the countdown	While the countdown is paused, press the [S/S] key.
Reset the countdown time	While the countdown is paused or stopped, press the [C/R] key. <ul style="list-style-type: none"> This resets to the countdown start time.

Using the Presentation Timer (TIMER)

The presentation time shows the time remaining for a presentation. Under initial default settings, the presentation timer is displayed discreetly in the lower right corner of the projection screen.



Important!

- To use the presentation timer, change “Option Settings 2 → Timer Type” (page 61) on the Setup Menu to “Presentation”.

To display the timer

When the timer is not displayed on the projected image, press the [TIMER] key once.

The timer will appear for about five seconds and then disappear automatically if the “Off” is selected for the “Continuous Display” setting on the timer function menu.

To display the timer function menu

When the timer is not displayed on the projected image, press the [TIMER] key twice. If the timer is displayed, press the [TIMER] key once.

To configure timer settings

1. Use the [TIMER] key to display the timer function menu.
2. Use the [▼] and [▲] keys to select the “Position”, “Continuous Display”, or “Start Time” setting and then change the settings as described in the table below.

To do this:	Perform this operation:
Reposition the timer on the projected image	Select “Position”, and then use the [◀] and [▶] keys to select one of the following settings: “Lower Right”, “Upper Right”, “Upper Left”, “Lower Left” (Initial default: Lower Right).
Enable or disable continuous display of the timer	Select “Continuous Display”, and then use the [◀] and [▶] keys to select either “On” or “Off” (Initial default: Off). On: Once the timer is displayed, it remains displayed until you display a different dialog box or you press the [ESC] key. Off: The timer automatically disappears about five seconds after it is displayed.
Specify the timer countdown start time	Select “Start Time”, and then use the [◀] and [▶] keys to specify the countdown start time you want. You can set a start time from five to 60 minutes, in five-minute steps (Initial default: 20 minutes).

3. To save your settings and close the timer function menu, press [ESC].
 - To start the timer immediately after changing its settings, use [▼] and [▲] to select “Start Timer” on the timer function menu and then press the [ENTER] key before pressing [ESC] in the step above.

Timer Operations

Perform all of the operations below while the timer function menu (page 54) is displayed.

To do this:	Perform this operation:
Start a countdown timer operation	Select "Start Timer" and then press the [ENTER] key. <ul style="list-style-type: none">● This will close the timer function menu and start the timer countdown.● After the countdown reaches 00:00, it will start a 60-minute count up operation (from -00:01 to -60:00). The numerals of the timer display are red (indicating that the presentation is over time) during a count up operation.
Pause the timer countdown	Select "Pause Timer" and then press the [ENTER] key.
Resume a paused timer countdown	Select "Restart Timer" and then press the [ENTER] key.
Reset the timer to its start time	Select "Reset Timer" and then press the [ENTER] key. <ul style="list-style-type: none">● This will reset the time to the "Start Time" setting.

Using the Setup Menu (MENU)

Pressing the [MENU] key displays the Setup Menu on the projection screen. You can use this menu to adjust projected image brightness, contrast, and other settings, and to change projector settings.



Setup Menu Settings

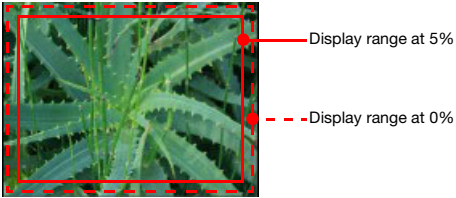

- One or more letters (such as RCV) after the menu item name indicates an item that is available only when one or more particular input source is selected. The letters indicate the input source(s) where the menu item is available.
R: RGB input, **C:** Component input, **V:** Video input, **H:** HDMI (PC) input,
D: HDMI (DTV) input, **T:** CASIO USB Tool*¹, **N:** Network*¹
¹ Network model projectors only
- A menu item that does not have any letter after it will be available regardless of the input source.
- The meanings of the symbols that appear after the menu items are shown below.
F XJ-F Series models only **UT** XJ-UT Series models only
N Network models only
- The initial default setting is indicated by an asterisk (*).

Use this menu item:	To do this:
Image Adjustment 1 → Brightness	Adjust projected image brightness.
Image Adjustment 1 → Contrast	Adjust projected image contrast.
Image Adjustment 1 → Sharpness (V)	Adjust the sharpness of the outlines in the projected image. A larger value makes the image sharper, while a smaller value makes it softer.
Image Adjustment 1 → Saturation (V)	Adjust the color saturation of the projected image. A larger value increases color saturation.
Image Adjustment 1 → Tint (V)	Adjust the tint of the projected image. A larger value makes the overall image more bluish, while a smaller value makes the overall image more reddish. This setting is supported only when the signal is NTSC or NTSC4.43.
Image Adjustment 1 → Color Mode	Select one of the following projected image color modes: "Standard"* ¹ , "Graphics", "Theater"* ¹ , "Blackboard", "Natural".  Note <ul style="list-style-type: none"> ● Initial default setting: "Theater" when the input source is Video, Component, or HDMI (DTV). "Standard" any other time.
Image Adjustment 1 → Color Balance	Select one of the following color balance presets: "Warm", "Normal"* ¹ , "Cold". Also can be used to separately adjust red, green, and blue.
Image Adjustment 1 → Light Control Off Mode	Specify either "Bright" (brightness priority) or "Normal"* ¹ (hue priority) as the image quality setting when "Off" is selected for "Option Settings 1 → Light Control → Light Control".
Image Adjustment 1 → Restore Menu Defaults	Return all of the items in the "Image Adjustment 1" main menu to their initial defaults for the currently projecting image source.

Use this menu item:	To do this:
Image Adjustment 2 → Vertical Position (RCV) Image Adjustment 2 → Horizontal Position (RCV)	Adjust the vertical and horizontal positions of the input source image in relation to the target screen.
Image Adjustment 2 → Frequency (R)	Adjust the frequency setting manually. Adjust manually when vertical bands appear in the projected image while RGB is selected as the input source, which means that the frequency setting is not correct. If, for some reason, your manual frequency settings cause the image input from the computer to disappear from the projection, you can press the [AUTO] key to perform an auto adjust operation, which should restore the image.
Image Adjustment 2 → Phase (R)	Adjust the phase of the RGB input signal when the image flickers because the projector phase and RGB input signal phase do not match.
Image Adjustment 2 → Overscan (CVD)	Adjust the overscan amount for an input video signal within the range of 0% to 5%*. The size of the border area displayed on the projection screen depends on the setting value. A smaller value results in a wider border area as shown below. 
Image Adjustment 2 → Restore Menu Defaults (RCVD)	Return all of the items in the “Image Adjustment 2” main menu to their initial defaults for the currently projecting image source.
Volume Adjustment → Volume	Adjust the volume level. For details, see “Adjust the volume level (VOLUME)” (page 46).
Volume Adjustment → Restore Menu Defaults	Return the Volume setting to its initial default for the currently projecting image source.
Screen Settings → Vertical Keystone Correction UT	Correct vertical keystone of the projected image.
Screen Settings → Horizontal Keystone Correction UT	Correct horizontal keystone of the projected image.
Screen Settings → Correction Priority UT	Enable or disable keystone corrected projection image distortion reduction. Shape: Reduces projected image distortion when keystone correction is performed. The resulting projection area will be slightly smaller than normal. Size*: With this setting, the normal projection area size is maintained for a keystone corrected image, but there may be some projected image distortion.
Screen Settings → Keystone Correction F	Correct vertical keystone of the projected image.
Screen Settings → Aspect Ratio	Select an aspect ratio setting for the projected image. See “Change the aspect ratio of the projected image (ASPECT)” (page 46) for more information.

Use this menu item:	To do this:
Screen Settings → Projection Mode	Specify whether projection will be from the front of the screen or the back of the screen. Front*: Select this option to project from the front of the screen. Rear: Select this option to project from the back of the screen. This setting flips the front projected image horizontally.
Screen Settings → Ceiling Mount	Set up the projector to be positioned upside down for mounting on a wall. On: Select when the projector is positioned upside down for mounting on a wall. Since the bottom of the projector is upwards, the projected image is flipped both horizontally and vertically. Off*: Select when the projector is used on a desktop. This projects the image assuming that the top of the projector is upwards.
Screen Settings → No Signal Screen	Select one of the following as the projection image whenever there is no input signal being input to the projector: "Blue"* (blue screen), "Black" (black screen), "Logo" (projector built-in logo, or user logo, page 32), "Test Pattern". Also note that selecting "Test Pattern" for this item will cause Auto Power Off (page 60), Auto Projection Off (page 43), and Auto Input Search (page 59) to be disabled while a test pattern is being projected when there is no signal.
Screen Settings → Blank Screen	Select one of the following as the projection image whenever the [BLANK] key is pressed: "Blue" (blue screen), "Projection Off"* (light off), "Logo" (projector built-in logo, or user logo, page 32), "Test Pattern".
Screen Settings → Auto Projection Off	Specify whether or not to turn off the projection light automatically when the input signal from the input source device is lost during projection. Enable: Auto Projection Off enabled. Disable*: Auto Projection Off disabled. For details about the Auto Projection Off operation see "Using Auto Projection Off" (page 43).
Screen Settings → Digital Screen Shift	Shift the digital screen. For details, see "Digital Screen Shift" (page 49).
Screen Settings → Restore Menu Defaults	Return all of the items in the "Screen Settings" main menu to their initial defaults for the currently projecting image source.
Input Settings → COMPUTER1 Terminal/ COMPUTER2 Terminal (RC) UT	Specify the method to be used to identify the COMPUTER IN 1/COMPUTER IN 2 terminal input signal. Auto*: Projector automatically identifies the COMPUTER IN 1/COMPUTER IN 2 terminal input signal. RGB: Always assumes the COMPUTER IN 1/COMPUTER IN 2 terminal input signal is an RGB signal. Component: Always assumes the COMPUTER IN 1/COMPUTER IN 2 terminal input signal is a component video signal.
Input Settings → RGB1 Level Adjust/RGB2 Level Adjust (R) UT	Enable (On*) or disable (Off) level adjustment of the input RGB signal. "RGB1 Level Adjust" corresponds to the RGB signal input from the COMPUTER IN 1 terminal, while "RGB2 Level Adjust" corresponds to the RGB signal input from the COMPUTER IN 2 terminal. Though you should use the "On" setting for most normal projection, this setting may produce distorted images for some input signals. If this happens, try changing this setting to "Off".

Use this menu item:	To do this:
Input Settings → COMPUTER Terminal F	Specify the method to be used to identify the COMPUTER IN terminal input signal. Auto*: Signal input to the COMPUTER IN terminal is identified automatically. RGB: Signal input to the COMPUTER IN terminal is always assumed to be an RGB signal. Component: Signal input to the COMPUTER IN terminal is always assumed to be a component video signal.
Input Settings → RGB Level Adjust F	Enable (On*) or disable (Off) level adjustment of the RGB signal being input from the COMPUTER IN terminal. Though you should use the “On” setting for most normal projection, this setting may produce abnormal images for some input signals. If this happens, try changing this setting to “Off”.
Input Settings → Video Signal (V)	Specify the method to be used to identify the VIDEO terminal input signal. Auto*: Projector automatically identifies the video input signal. NTSC, NTSC4.43, PAL, PAL-M, PAL-N, PAL60, SECAM: Always assumes the video input signal is the specified video signal type.
Input Settings → Signal Name Indicator	Specify whether the newly selected input signal type should be displayed (On*) or not displayed (Off) when the [INPUT] key is pressed to change the input signal.
Input Settings → Auto Input Search	Specify whether or not to search for an input source when the projector is turned on or when then [INPUT] key is pressed. On*: Auto Input Search enabled. Off: Auto Input Search disabled. For details about the Auto Input Search operation, see “Using Auto Input Search” (page 39).
Input Settings → Restore Menu Defaults	Return all of the items in the “Input Settings” main menu to their initial defaults for the currently projecting image source.
Option Settings 1 → Auto Keystone Correction F	Enable (On*) or disable (Off) keystone correction in accordance with the angle of the projector.  Note _____ <ul style="list-style-type: none"> ● This setting item cannot be selected and auto keystone correction is disabled while the “On” is selected for “Screen Settings → Ceiling Mount”.
Option Settings 1 → Auto Adjust (R)	Specify whether the projector should detect the RGB input signal type (resolution, frequency) and adjust the projection image accordingly. On*: Auto Adjust enabled. Off: Auto Adjust disabled.  Note _____ <ul style="list-style-type: none"> ● If you want to retain the following “Image Adjustment 2” menu settings when power is turned off, select “Off” for this setting: “Vertical Position”, “Horizontal Position”, “Frequency”, “Phase”.
Option Settings 1 → Light Control → Light Output	Adjust light output. For details, see “Light Control” (page 48).

Use this menu item:	To do this:
Option Settings 1 → Light Control → Light Sensor	Enable or disable the light sensor. On: Enables automatic adjustment of light output in accordance with surrounding light. Off*: Disables automatic adjustment of light output.
Option Settings 1 → Light Control → Light Control	Enable or disable projector light output (light source brightness). On*: Enables light output adjustment. Off: Disables light output adjustment and “Light Sensor” (above). This setting must be selected when you want the light source to output at maximum brightness.
Option Settings 1 → Auto Power Off	Specify the amount of time of projector operation and input signal inactivity to be allowed before Auto Power Off is triggered to turn off projector power automatically. Auto Power Off can be disabled, if you want. 5 min, 10 min*, 15 min, 20 min, 30 min: Time until Auto Power off is triggered. Off: Disables Auto Power Off.
Option Settings 1 → Password	Configure password settings. For details, see “Using a Password” (page 63).
Option Settings 1 → Direct Power On	Enable (On) and disable (Off*) projector auto power on as soon as the projector’s AC power cord is plugged into a power outlet.
Option Settings 1 → Projector ID	Configure projector ID settings. For details, see “Configuring Remote Control ID and Projector ID Settings” (page 52).
Option Settings 1 → Language	Specify the display language. English, French, German, Italian, Spanish, Swedish, Portuguese, Dutch, Norwegian, Polish, Finnish, Czech, Turkish, Russian, Lithuanian, Vietnamese, Thai, Malay, Indonesian, Arabic, Chinese (Simplified), Chinese (Traditional), Korean, Japanese  Important! ● Network Model Users When using certain Network model functions, some menus and messages may be displayed in English, regardless of the language selected here.
Option Settings 1 → Restore Menu Defaults	Return all of the items in the “Option Settings 1” main menu to their initial defaults for the currently projecting image source.
Option Settings 2 → Audio Out	Specify whether audio input from the input sources should be output to the projector’s speaker (Speaker*) or output to an external destination from the projector’s AUDIO OUT terminal (Line).
Option Settings 2 → Audio Input	Change the audio input. For details, see “Changing the Audio Input” (page 42).
Option Settings 2 → High Altitude	Turn the high-altitude fan speed setting on or off in accordance with the altitude of the area where you are using the projector. On: Select this setting when using the projector in a high altitude (1,500 to 3,000 meters / 5,000 to 10,000 feet above sea level) area where air is thin. This setting increases cooling efficiency. Off*: Select this setting at normal altitudes (up to 1,500 meters / 5,000 feet).  Important! ● Do not use this projector at altitudes greater than 3,000 meters (10,000 feet) above sea level.

Use this menu item:	To do this:
Option Settings 2 → Control Panel Lock	Disable projector unit key operations. See “Control Panel Lock” (page 51) for more information.
Option Settings 2 → Standby RGB/Audio UT	Specify output of projector image input to the MONITOR OUT terminal and input audio to the AUDIO OUT terminal while the projector is in standby (projector off with power being supplied). The output image is fixed as the video signal from the projector COMPUTER IN 1 terminal. The output audio is the audio signal from the audio input terminal assigned to “Computer1” of the input source, and the audio signal from the MIC terminal. Output: Select this setting to output video and audio signals while the projector is in standby. No Output*: Select this setting not to output video and audio signals while the projector is in standby.  Note <ul style="list-style-type: none"> ● When “Output” is selected for this setting, audio is output from the AUDIO OUT terminal during standby, regardless of the projector’s current “Option Settings 2 → Audio Out” setting. ● The video signal input to the projector’s COMPUTER IN 2 terminal cannot be output from the MONITOR OUT terminal.
Option Settings 2 → Closed Caption (V)	Specify whether to display closed captions when projecting a video signal that includes them. Off*: Closed captions not displayed. CC1, CC2, CC3, CC4: Indicates the current closed caption output setting (CC1, CC2, CC3, and CC4).
Option Settings 2 → Timer Type	Select the type of timer to be projected when the [TIMER] key is pressed. Countdown*: Projects a countdown timer (page 52). Presentation: Projects a presentation timer (page 54).
Option Settings 2 → Timer Function	Display the countdown time setting screen (page 53) when “Countdown” is selected for “Option Settings 2 → Timer Type”. If “Presentation” is selected, this menu item shows the timer function menu (page 54).
Option Settings 2 → Microphone Input Level (XJ-UT Series/XJ-F21XN/ XJ-F211WN)	Adjust the volume level of audio input from the MIC terminal within the range of 0* (mute) to 3 (maximum).
Option Settings 2 → Restore Menu Defaults	Return all of the items in the “Option Settings 2” main menu to their initial defaults for the currently projecting image source.
Network Settings*1 → Wired LAN info N	View information about the current wired LAN connection status.
Network Settings*1 → Wireless LAN Info N	View information about the current wireless LAN connection.
Network Settings*1 → Network Settings → IP Setting(LAN1) N	Specifies how an IP address is specified when the projector is connected to a network. Auto*: IP address is obtained automatically from a network DHCP server. Manual: Manual IP address input. When “Manual” is selected, settings for the following items can also be specified manually: “IP Address”, “Subnet Mask”, “Default Gateway”.

Use this menu item:	To do this:
Network Settings*1 → Network Settings → Wireless LAN Function N	Toggle the projector's wireless LAN function between "Enable"* and "Disable".
Network Settings*1 → Network Settings → Remote On N	Specify whether the projector can be turned on via wired LAN while the projector is in standby (projector off with power being supplied). Enable: Remote on enabled. Disable*: Remote on disabled. Projector standby power consumption depends on whether or not "Remote On" is enabled. For information about power consumption in each standby state, see "Specifications" (page 83).
Network Settings*1 → Network Settings → PJLink Authentication N	Enable or disable PJLink connection authentication. Initial default setting: Enable.
Network Settings*1 → Network Settings → Update Network Settings N	Apply changes to the "Network Settings → Network Settings" menu items to projector settings.
Network Settings*1 → Network Settings → Initialize Network Settings N	Return network settings to their initial factory defaults.
Operational Info	Display the projector information below. Input Signal, Signal Name, Resolution, Horizontal Frequency, Vertical Frequency, Scan System, Audio Input, Projector ID, Light Time, Version (projector ROM version), Board Number (unique board number of each product)
Restore All Defaults → Unit Operating Time	Display the cumulative operating time of this unit. This time cannot be initialized.
Restore All Defaults → Restore All Defaults	Initialize all Setup Menu item settings, except for those below. Language, Power On Password, Network Setting Password, Network Settings, Light Time, Unit Operating Time  Note ● A user logo image that has been transferred to the projector (page 32) is not deleted by a "Restore All Defaults" operation.

*1 For details about how to configure the settings of the "Network Settings" menu items, refer to the separate "Network Function Guide".

Using a Password

You can use the procedure in this section to password protect projector operations. You can have only one password assigned to the projector at any time, and the same password is used for operations.

- **Power On Password Protection**

Turning on the projector will display a dialog box prompting input of the password.

- **Network Setting Password Protection (Network Models Only)**

Attempting to access “Network Settings → Network Settings” (page 61) with the Setup Menu will cause a password input dialog box to appear.

Configuring Password Settings

To do this:	Perform this operation:
Change the password	<ol style="list-style-type: none"> 1. Press the [MENU] key to display the setup menu. 2. Select “Option Settings 1”, “Password”, and then press the [ENTER] key. 3. Enter the current password, and then press the [ENTER] key. <ul style="list-style-type: none"> ● The password of your projector is a sequence of remote controller key inputs. If the projector is still protected by the factory default password, perform the key operation shown below to enter it. <div style="border: 1px solid black; padding: 5px; text-align: center; margin: 10px 0;"> [▲] [▼] [◀] [▶] [▲] [▼] [◀] [▶] </div> 4. Use the [▼] key to select “Change Password”, and then press the [ENTER] key. 5. Enter a key sequence up to eight key operations long, and then press the [ENTER] key. <ul style="list-style-type: none"> ● You can use any of the following keys as part of your password key sequence. [INPUT], [MENU], [BLANK], [FREEZE], [⏻], [VOLUME +], [VOLUME -], [D-ZOOM +], [D-ZOOM -], [KEYSTONE +], [KEYSTONE -], [▲], [▼], [◀], [▶], [TIMER], [AUTO], [ASPECT], [FUNC] 6. Re-enter the same password key sequence you entered in step 5 and then press the [ENTER] key. <ul style="list-style-type: none"> ● The message “Your new password has been registered.” indicates that the password has been changed. Press the [ESC] key. ● If the password you entered in this step is different from the one you entered in step 5, the message “The password you input is wrong.” appears. Press the [ESC] key to return to step 5.
Change the power on password protection setting	<ol style="list-style-type: none"> 1. Perform steps 1 through 3 of the procedure under “Change Password” to display the password function setting screen. 2. After confirming that “Power On Password” is selected, use the [◀] and [▶] keys to switch between “On” and “Off”. <ul style="list-style-type: none"> ● Changing this setting from “Off” to “On” will cause the “Prompt for password when power is turned on?” dialog box to appear. To select “On” for this setting press the [ENTER] key. To exit without changing the settings, press the [ESC] key. 3. After you are finished, press the [MENU] key to exit the setup menu.
Change the network setting password protection setting (Network models only)	<ol style="list-style-type: none"> 1. Perform steps 1 through 3 of the procedure under “Change Password”. 2. Use the [▼] key to select “Network Setting Password”. 3. Use the [◀] and [▶] keys to switch between “On” and “Off”. <ul style="list-style-type: none"> ● Changing this setting from “Off” to “On” will cause the “Prompt for password when a network setting operation is performed?” dialog box to appear. To select “On” for this setting press the [ENTER] key. To exit without changing the settings, press the [ESC] key. 4. After you are finished, press the [MENU] key to exit the setup menu.

Using the Password Feature

Note the following precautions whenever you use the password feature.

- The password feature protects against unauthorized use of the projector. Note that it is not an anti-theft measure.
- You will need to enter the initial factory default password the first time you use the projector after turning on the password feature. Change the initial factory default password to a different one of your choice as soon as possible after turning on the password feature.
- The remote controller is required to input the password. Take care to avoid misplacing the remote controller. Replace the remote controller batteries as soon as possible after they start to go low.
- When inputting the password, the remote controller ID and the projector ID must be the same, or either the remote controller ID or projector ID must be set to “All”. For more information, see “Configuring Remote Control ID and Projector ID Settings” (page 52).
- You will not be able to use the projector if you forget its password. We strongly suggest that you keep a written or other type of record of the password so you can look it up when necessary.

If you forget your password...

You will need to bring the projector and valid identification (original or copy of your employee I.D., driver’s license, etc.) to a specified repair service provider. Note that you will be charged to have the password cleared. Having your password cleared using the procedure described above will return all of the settings of your projector, except for the Light Time, to their initial factory defaults.

Cleaning the Projector

Make it a habit to clean the projector at regular intervals as described in this section. Before cleaning the projector, be sure to unplug it from the power outlet and make sure it is cooled down completely.

Cleaning the Projector Exterior

Wipe the exterior of the projector with a soft cloth that has been moistened in a weak solution of water and a mild neutral detergent. Be sure to wring all excess moisture from the cloth before wiping. Never use benzene, alcohol, thinner, or any other volatile agent for cleaning.

Cleaning the Lens

Carefully wipe the lens with a commercially available lens cloth or optical lens paper, like those for eyeglasses or camera lenses. When cleaning the lens, do not apply undue force and take care to avoid damaging the lens.

Cleaning Vents

Dust and dirt tend to collect around the intake vents. Because of this, you should use a vacuum cleaner to clean away accumulated dust and dirt periodically (about once a month) as shown below.

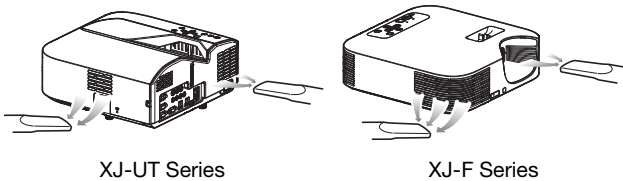

XJ-UT Series

XJ-F Series



Important!

- Continued use of the projector after dust has accumulated around the intake vents can cause overheating of internal components and lead to malfunction.
- Certain operating conditions also can cause dirt and dust to accumulate around the projector's exhaust vents. If this happens, use the same procedure as that described above to clean the exhaust vents.

Troubleshooting

Normal Operation Indicators

The color and on/off/flashing status of the indicators let you know the current operational status of the projector. The table below shows what the indicators look like when operation is normal.

■ : Lit ★ : Flashing

When the indicators appear like this:					It means this:
XJ-UT Series			XJ-F Series		
POWER/ STANDBY ■ Red	LIGHT ■ Amber	TEMP ■ Amber	POWER/ STANDBY ■ Amber	STATUS ■ Amber	The projector has just been plugged into a power outlet. Wait until the projector enters the standby state (see below) before trying to turn on power.
■ Red			■ Red		Standby state: The AC power cord is plugged in and the projector is in standby.
XJ-UT312WN/XJ-UT352WN ★ ■ ■ Green Amber Amber			XJ-F21XN/XJ-F211WN ★ ■ Green Amber		Projector is warming up after being turned on.
XJ-UT352W ★ ■ Green Green			XJ-F11X/XJ-F101W ★ ■ Green Green		
■ ■ Green Green		■ ■ Green Green			Projector is on and standing by for use. "On" is selected for the projector's "Light Control" setting.
■ Green		■ Green			Projector is on and standing by for use. "Off" is selected for the projector's "Light Control" setting.
★ → ■ ■ ■ Green Amber Amber	■ ■ Amber Amber		★ → ■ ■ ■ Green Amber		Projector is performing an internal process to prepare for network system startup (network models only).
★ Red			★ Red		Projector is performing internal power down processes.



Note

- The POWER/STANDBY indicator will flash green if the projector is turned on but the projection light has been turned off by Auto Projection Off (page 43).

Error Indicators and Messages



Important!

- If you turn off power or if power turns off automatically after an error occurs, first confirm that the projector's fan is stopped. After the fan stops, unplug the power cord. An error will not be cleared if you unplug the power cord while the fan is running.

Error Messages

Error Messages	Description and Required Action
Internal temperature is too high. Check projector air vents for blockage. (POWER/STANDBY indicator lights green.)	<p>The projector's internal temperature is very high. Perform the following steps.</p> <ul style="list-style-type: none"> ● Check for any blocking of the projector's intake vents and exhaust vents, and make sure that there is sufficient space around the projector. See "Setup Precautions" (page 26). ● If there is dust accumulated around the intake vents and/or exhaust vents, turn off the projector and remove it. See "Cleaning the Projector" (page 65).
Internal temperature is too high. The projector will turn off. (POWER/STANDBY indicator light changes from green to red.)	<p>Power has turned off automatically due to internal overheating. Perform the following steps.</p> <ul style="list-style-type: none"> ● Check for any blocking of the projector's intake vents and exhaust vents, and make sure that there is sufficient space around the projector. See "Setup Precautions" (page 26). ● If there is dust accumulated around the intake vents and/or exhaust vents, remove it. See "Cleaning the Projector" (page 65). <p>If there is no problem with the projector's vents, confirm that the POWER/STANDBY indicator is lit red (without flashing), and then turn power back on again. If the error occurs again when you turn power back on, contact your retailer or nearest authorized CASIO Service Center.</p>

Indicator Status When an Error Occurs

Fan error

XJ-UT Series	XJ-F Series
POWER : Lit red	POWER : Lit red
LIGHT : Lit red	STATUS : Flashes amber (Approximately 0.5-second intervals)
TEMP : Lit red	

Power has turned off automatically due to a fan problem. Confirm that the POWER/STANDBY indicator is lit red (without flashing) and that the fan has stopped. After checking the POWER/STANDBY indicator, disconnect the power cord from the projector and wait for all of the projector's indicators to go out. Next, reconnect the power cord and turn projector power back on. If the error occurs again when you turn power back on, contact your retailer or nearest authorized CASIO Service Center.

System Errors and Other Operation Problems

XJ-UT Series	XJ-F Series
POWER : Lit red	POWER : Lit red
LIGHT : –	STATUS : Lit red
TEMP : Lit red	

The projector was automatically turned off because of a system problem or because of an operational problem caused by external noise. After confirming that the POWER/STANDBY indicator is lit red (without flashing), disconnect the power cord from the projector and wait for all of the projector's indicators to go out. Next, reconnect the power cord and turn the projector back on. If the error occurs again when you turn power back on, contact your retailer or nearest authorized CASIO Service Center.

Light Source Unit Problems

XJ-UT Series	XJ-F Series
POWER : Lit red	POWER : Lit red
LIGHT : Flashes red (at approximately 1-second intervals)	STATUS : Flashes red (at approximately 1-second intervals)
TEMP : Flashes red (at approximately 1-second intervals)	

The projector was turned off automatically because the light source unit turned off or did not turn on. After confirming that the POWER/STANDBY indicator is lit red (without flashing), unplug the power cord. Wait for a short while and then plug it back in and turn on the projector again. If the error occurs again when you turn power back on, contact your retailer or nearest authorized CASIO Service Center.

Memory Error

XJ-UT Series	XJ-F Series
POWER : Lit red	POWER : Lit red
LIGHT : Unlit or flashes red	STATUS : Flashes red (at approximately 2-second or 1-second intervals)
TEMP : Flashes red (at approximately 2-second intervals)	

Power has turned off automatically due to a projector memory error. Confirm that the POWER/STANDBY indicator is lit red (without flashing). After checking the POWER/STANDBY indicator, disconnect the power cord from the projector and wait for all of the projector's indicators to go out. Next, reconnect the power cord and turn projector power back on. If the error occurs again when you turn power back on, contact your retailer or nearest authorized CASIO Service Center.

Projector Troubleshooting

Check the following items whenever you experience any problem with the projector.

Problem	Cause and Recommended Action
Power does not turn on.	<ul style="list-style-type: none"> ● If the POWER/STANDBY indicator is not lit, the AC power cord is not connected correctly. Connect the AC power cord correctly. ● If the TEMP or LIGHT indicator (XJ-UT Series models), or the STATUS indicator (XJ-F Series models) remains flashing or lit, it means that some type of error has occurred. See “Indicator Status When an Error Occurs” (page 67).
No image is projected or the projected image is abnormal.	<ul style="list-style-type: none"> ● The computer or video device connected to the projector is not turned on or it is not outputting a video signal. Make sure the connected computer or video device is turned on, and perform the required operation on it to output a video signal. ● The correct output source is not selected on the projector. On the projector, select the correct input source that corresponds to the connected device. ● If the input signal you are trying to project is a component video signal, the image may not project correctly due to the type of video device connected to the projector. If this is the case try projecting with the video device’s composite video output terminal connected to the projector’s VIDEO terminal.
Image color or display is very abnormal. (When projecting a computer RGB signal or a video device component video signal)	<p>This may be due to a signal setting that does not match the input signal. Check one of the settings described below and select “RGB” or “Component” to match the input signal, or select the “Auto” setting.</p> <p>XJ-UT Series Models Depending on the terminal where the input source device is connected, check the current setting of “Input Settings → COMPUTER1 Terminal” or “Input Settings → COMPUTER2 Terminal”. Change the setting if required.</p> <p>XJ-F Series Models Check the current setting of “Input Settings → COMPUTER Terminal”, and change the setting if required.</p>
I can’t understand messages or menus because they are the wrong language.	<p>Perform the following operation to select the language you want.</p> <ol style="list-style-type: none"> 1. Press the [MENU] key to display the setup menu. 2. If the input signal is HDMI (PC), press [▼] four times and then press the [ENTER] key. If the input signal is not HDMI (PC), press [▼] five times and then press the [ENTER] key. 3. Press [▲] twice and then press the [ENTER] key to display the language selection menu. 4. Use the [▼] and [▲] keys to move the highlighting to the language you want to select and then press the [ENTER] key. 5. Press the [MENU] key to exit the setup menu.
No sound	<ul style="list-style-type: none"> ● The projector’s volume level setting may be too low or muted. Use the remote controller [VOLUME +] and [VOLUME -] keys to adjust the volume level. ● The volume level setting of the device connected to the projector is too low or the other device is not outputting audio. Adjust the volume level of the connected device. ● Audio output of the audio device connected to the audio input terminal assigned to the currently projecting input source may not be connected correctly. For more information, see “Relationship Between Image Input and Audio Input” (page 41). ● “Line” may be selected for the “Option Settings 2 → Audio Out” setting on the setup menu. Change the “Audio Out” setting to “Speaker”.
Strange color	<p>The input signal may not match projector settings. Try doing the following.</p> <ul style="list-style-type: none"> – Press the [FUNC] key and then select “Brightness” to adjust image brightness. – Press the [FUNC] key and then select “Color Mode” to change the color mode. – On the setup menu, use “Image Adjustment 1 → Color Balance” to adjust the projection image color balance.

Problem	Cause and Recommended Action
Text is blurry.	<ul style="list-style-type: none"> ● The image may be out of focus. Adjust image focus. ● The current frequency and/or phase setting do not match the input signal. (Applies only when the input source is an RGB signal.) Press the [AUTO] key to execute an automatic adjustment operation. ● On the setup menu, perform the “Image Adjustment 2 → Frequency” and “Image Adjustment 2 → Phase” adjustments. (Applies only when the input source is an RGB signal.)
Turning on projector power causes the following message to appear “Please input the password.” and the projector stands by for password input.	The “Option Settings 1 → Password → Power On Password” setting on the setup menu is turned on, so the projector is password protected. Input the correct password, and then press the [ENTER] key. See page 63. If you are unable to input the password with the remote controller keys, see “The remote controller does not work.” below.
The remote controller does not work.	<ul style="list-style-type: none"> ● The remote controller batteries may be dead. Replace the batteries. ● The remote controller may be too far from the projector. Make sure the remote controller is within about five meters from the projector when performing operations. ● The remote control ID and projector ID may not match. Change the two IDs so they are the same, or change one of the IDs to “All”. For more information, see “Configuring Remote Control ID and Projector ID Settings” (page 52).
The TEMP or LIGHT indicator (XJ-UT Series models), or the STATUS indicator (XJ-F Series models) is flashing or lit.	Some error may have occurred. See “Indicator Status When an Error Occurs” (page 67).
The light source unit does not light.	<ul style="list-style-type: none"> ● The light source has been temporarily shut off by pressing the [BLANK] key. Press the [BLANK] or [ESC] key. ● The light source unit has reached the end of its service life or it is malfunctioning. Contact your original dealer or authorized CASIO service center for replacement.
Power suddenly turns off and the projector restarts.	The projector periodically performs a self-check operation. In rare cases, the result of a self-check may cause the projector to restart automatically. This normally does not indicate malfunction, so you can continue using the projector. However, malfunction may be indicated if successive restarts keep occurring. If this happens contact your original dealer or authorized CASIO service center.



Important!

- **Try performing the following steps, which may or may not return the projector to normal operation.**
 - 1. Unplug the AC power cord and wait for at least 10 minutes.**
 - 2. Plug the power cord back in and turn the projector back on again.**
- **If normal operation does not resume after you perform the above steps, take the projector to your retailer or authorized CASIO service center.**

Checking the Serial Number and Board Number

Each projector is assigned a unique serial number and board (circuit board) number to identify it. You can find these numbers at the locations shown below.

Serial Number

The serial number is shown on label affixed to the projector.

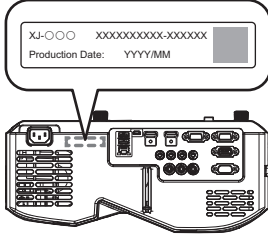

XJ-UT Series

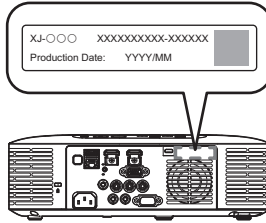

XJ-F Series

Board Number

You can use the procedure below to display the Setup Menu “Operational Info”, which shows the board number.

- 1. Press the [MENU] key to display the setup menu.**
- 2. Use the [▲] and [▼] keys to select “Operational Info”.**
 - Check the “Board Number” line.
- 3. Press the [MENU] key to close the setup menu.**

Supplying USB Power to Another Device

The terminals in the table below can be used to supply USB power to another device.

Model Name	Terminal Name	Power/Current
XJ-UT312WN, XJ-UT352WN	USB-A/DC 5V terminal USB-A terminal	DC 5V/1.5A DC 5V/0.5A
XJ-F21XN, XJ-F211WN	USB-A/DC 5V terminal	DC 5V/2A
XJ-UT352W, XJ-F11X, XJ-F101W	DC 5V terminal	DC 5V/2A



Important!

- Turning off projector power also cuts power being supplied to external equipment. Note that power being supplied is also cut when the projector is turned off due to restarting by its self-check function or Auto Power Off, due to some error, or for any other reason. Depending on the external equipment being used, cut off of the power supply may cause data that is being edited to be lost or corrupted. Make it a habit to frequently save data on external equipment being powered by the projector.
- Projector power being turned off by Auto Power Off (page 60) also causes power to external equipment to be cut off. Before starting power supply to external equipment, be sure to select “Off” for the setting “Option Settings 1 → Auto Power Off” to disable Auto Power Off.
- For a list of external equipment whose operation has been confirmed while being powered by the projector, visit the CASIO projector website (<https://world.casio.com/faq/projector/>). Proper operation is not guaranteed for any external device that is not included in the list at the CASIO projector website.
- Though voltage and current power may be able to be supplied to devices other than those listed on the CASIO website, note that doing so may result in some functions becoming unavailable on some devices. Before using output from this port to power another device, be sure to check the user documentation of the device and make sure you connect it correctly. Particular care is required when connecting a chargeable battery to this projector’s USB port power supply. Incorrect connection creates the risk of explosion, fire, and smoke.
- Note that CASIO COMPUTER CO., LTD. shall be held in no way liable for any loss or corruption of data stored on an external device connected to this projector’s USB port power supply, or for any damage, smoke generation, or fire occurring on the connected device.



Note

- To temporarily blank projection while maintaining power supply from the projector to external equipment, press the [BLANK] key. For more information, see “Momentarily blank the image and mute the audio (BLANK)” (page 45).
- Even if the projection light has been turned off by Auto Projection Off (page 43), USB power will continue to be supplied as long as the projector is turned on.

Mounting the Projector on a Wall (XJ-UT Series)

You can use special wall mounting hardware to mount the projector on a wall. In this configuration, the projector should be mounted with the top of the projector downwards.

For full details, contact the retailer where you purchased the projector.



Important!

- When mounting the projector on a wall, make sure that it is at least one meter away from fire detectors, fire alarms, and other fire protection devices. Locating the projector too close to a fire protection device creates the risk of mis-operation of the device due to warm air exhausted from the projector. Also, avoid locating the projector close to fluorescent lights or other strong light sources. Bright light can shorten the operating range of the remote controller or even make remote control impossible. When selecting a location for the projector, be sure to test for proper operation of the remote controller.
- The vertical and horizontal orientation of the projected image is reversed from normal when the projector is positioned upside down for mounting on a wall. You need to change the setup of the projector in order to correct for this. For details, see “Screen Settings → Ceiling Mount” (page 58) under “Setup Menu Settings”.

Hanging the Projector from a Ceiling (XJ-F Series)

The projector can be hung from a ceiling. When hanging a projector from the ceiling, you can orient it upside down or with the projection lens facing straight downwards.

For full details, contact the retailer where you purchased the projector.



Important!

- When hanging the projector from a ceiling, make sure that it is at least one meter away from fire detectors, fire alarms, and other fire protection devices. Locating the projector too close to a fire protection device creates the risk of mis-operation of the device due to warm air exhausted from the projector. Also, avoid locating the projector close to fluorescent lights or other strong light sources. Bright light can shorten the operating range of the remote controller or even make remote control impossible. When selecting a location for the projector, be sure to test for proper operation of the remote controller.
- The vertical and horizontal orientation of the projected image is reversed from normal when the projector is positioned upside down for hanging from a ceiling. You need to change the setup of the projector in order to correct for this. For details, see “Screen Settings → Ceiling Mount” (page 58) under “Setup Menu Settings”.

Using the MONITOR OUT Terminal (XJ-UT Series)

The MONITOR OUT terminal of the projector outputs the video signal being input via the COMPUTER IN 1 terminal or COMPUTER IN 2 terminal as-is. This makes it possible to simultaneously output the projection image to another display.



Note

- The signals output from the MONITOR OUT terminal when the projector is turned on depends on the selected input source as shown in the table below.

When this input source is selected:	The video input signal from this terminal is output to the MONITOR OUT terminal:
Computer1	COMPUTER IN 1
Computer2	COMPUTER IN 2
Video, HDMI1, HDMI2, CASIO USB Tool, Network	The video input signal is output from either Computer1 or Computer2, in accordance with the last selected input source (COMPUTER IN 1 terminal or COMPUTER IN 2 terminal).*1

*1 For example, even if the input source is switched from Computer1 to Video, the MONITOR OUT terminal continues output the video input signal from COMPUTER IN 1.

- The projector can be configured to output, from the MONITOR OUT terminal, the video signal input from the COMPUTER IN 1 terminal while the projector is in the standby state. For details, see “Option Settings 2 → Standby RGB/Audio” (page 61).

Projection Distance and Screen Size

The projection distance values below are for reference when setting up the projector.

XJ-UT Series

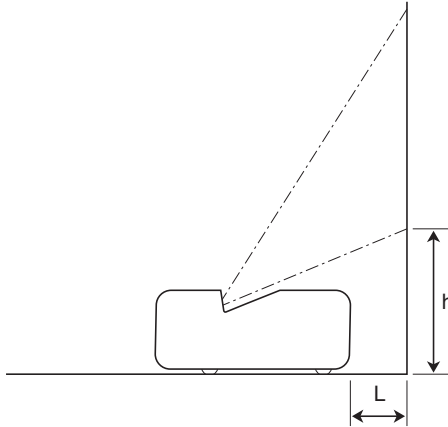

Projection Size		Projection Distance (Distance to projector front): L (cm / inch)	Height from Projector Bottom to Screen Bottom: h (cm / inch)
Screen Size	Diagonal (cm)		
50	127	6 / 2.4	24 / 9.4
60	152	13 / 5.1	27 / 10.6
80	203	27 / 10.6	32 / 12.6
100	254	40 / 15.7	38 / 15
110	279	47 / 18.5	40 / 15.7

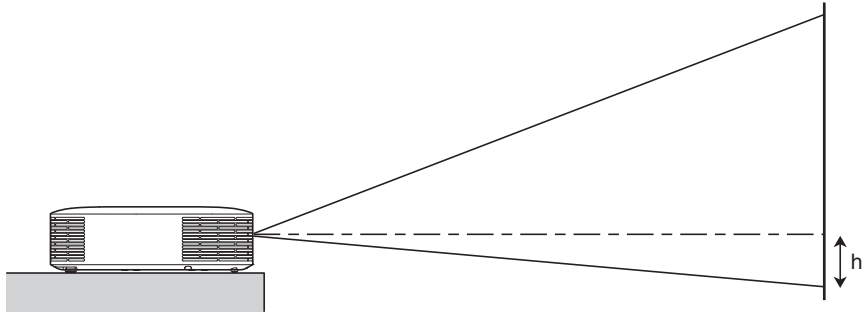











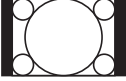

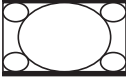

Projection Size		Approximate Projection Distance					
		XJ-F11X/XJ-F21XN			XJ-F101W/XJ-F211WN		
Screen Size	Diagonal (cm)	Minimum Distance (m / feet)	Maximum Distance (m / feet)	h	Minimum Distance (m / feet)	Maximum Distance (m / feet)	h (cm / inch)
30	76	0.93 / 3.05	1.38 / 4.53	0	-	-	-
35	89	-	-	-	0.92 / 3.02	1.37 / 4.49	8 / 3.15
40	102	1.27 / 4.17	1.88 / 6.17	0	1.06 / 3.48	1.58 / 5.18	9 / 3.54
60	152	1.95 / 6.4	2.87 / 9.42	0	1.64 / 5.38	2.42 / 7.94	13 / 5.12
77	196	2.54 / 8.33	3.72 / 12.2	0	2.14 / 7.02	3.14 / 10.3	17 / 6.69
80	203	2.64 / 8.66	3.86 / 12.66	0	2.22 / 7.28	3.26 / 10.7	18 / 7.09
100	254	3.33 / 10.93	4.85 / 15.91	0	2.81 / 9.22	4.11 / 13.48	22 / 8.66
150	381	5.04 / 16.54	7.33 / 24.05	0	4.26 / 13.98	6.22 / 20.41	34 / 13.39
200	508	6.76 / 22.18	9.82 / 32.22	0	5.72 / 18.77	8.32 / 27.3	45 / 17.72
300	762	10.18 / 33.4	14.78 / 48.49	0	8.63 / 28.31	12.54 / 41.14	67 / 26.38

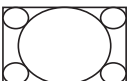
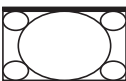
Aspect Ratio Setting and Projection Image



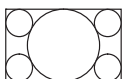
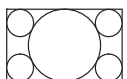

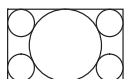
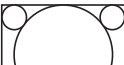
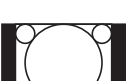
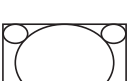

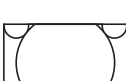



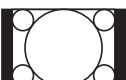

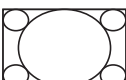
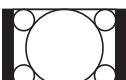



The following shows how images are projected in accordance with the type of the input signal and the aspect ratio setting of the projector.

WXGA models (1280 × 800)

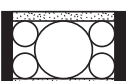
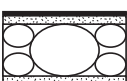
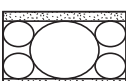
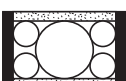
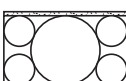
Input source: RGB, HDMI(PC), CASIO USB Tool, Network or Templates







Input Signal	Normal	Full	16:9	4:3	True
 SVGA (800 × 600)					
 XGA (1024 × 768)					
 WXGA (1280 × 800)					
 SXGA (1280 × 1024)					

Input source: Video, Component or HDMI(DTV)

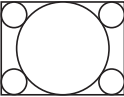
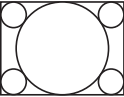
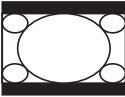

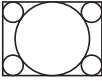
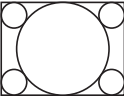
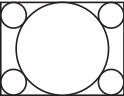
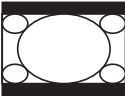

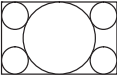
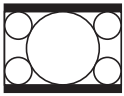
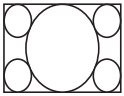
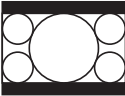
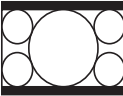
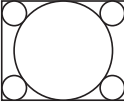
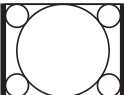
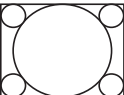

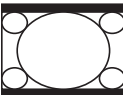
Input Signal	Normal	16:9	16:10	4:3	Letter Box
 4:3 Aspect Image					
 Squeezed Image					
 Letter Box Image					
 16:9 Aspect Image					

XGA models (1024 × 768)

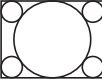
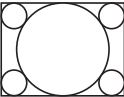
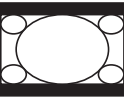
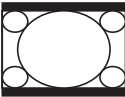
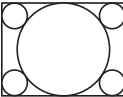
Input source: RGB, HDMI(PC), CASIO USB Tool, Network or Templates

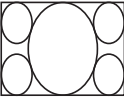
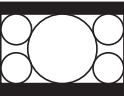
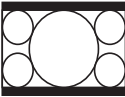
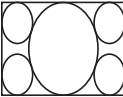
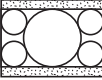
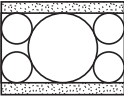
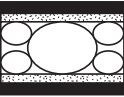
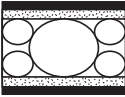
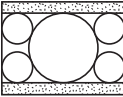
Input Signal	Normal	Full	16:9	16:10
 SVGA (800 × 600)				
 XGA (1024 × 768)				
 WXGA (1280 × 800)				
 SXGA (1280 × 1024)				

Input source: Video, Component or HDMI(DTV)

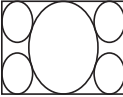
Input Signal	Normal	16:9	16:10	4:3
 4:3 Aspect Image				
 Squeezed Image				
 Letter Box Image				
 16:9 Aspect Image				

Supported Signals

RGB (VESA)	640 × 480/60
	640 × 480/72
	640 × 480/75
	640 × 480/85
	800 × 600/56
	800 × 600/60
	800 × 600/72
	800 × 600/75
	800 × 600/85
	1024 × 768/60
	1024 × 768/70
	1024 × 768/75
	1024 × 768/85
	1152 × 864/75
	1280 × 720/60
	1280 × 768/60
	1280 × 800/60
	1280 × 960/60
	1280 × 1024/60
	1280 × 1024/75
	1280 × 1024/85
	1366 × 768/60
	1400 × 1050/60
	1440 × 900/60
1600 × 1200/60	
1680 × 1050/60	
1920 × 1080/60	
1920 × 1200RB/60	
Video	NTSC, NTSC4.43, PAL, PAL-M, PAL-N, PAL60, SECAM

Component (HDTV)	1080p/50
	1080p/60
	720p/50
	720p/60
	1080i/50
	1080i/60
Component (SDTV)	576p/50
	576i/50
	480p/60
	480i/60
HDMI	640 × 480/60
	800 × 600/60
	1024 × 768/60
	1280 × 720/60
	1280 × 768/60
	1280 × 800/60
	1280 × 960/60
	1280 × 1024/60
	1400 × 1050/60
	1920 × 1080/60
	1920 × 1200RB/60
	SDTV (480p)
	SDTV (576p)
	HDTV (720p) (50)
	HDTV (720p) (60)
	HDTV (1080i) (50)
	HDTV (1080i) (60)
	HDTV (1080p) (50)
HDTV (1080p) (60)	

Projector RS-232C Control

To control the projector using RS-232C commands from a computer, you need to connect the projector and computer using a commercially available serial cable (cross).

Command Send Format

Communication Protocol	Data Rate: 19200 bps, Data Bit: 8 bit, Parity: None, Stop Bit: 1 bit, Flow Control: None	
Read Command	Send Format	(<command name>?)
	Receive Format	(<applicable command setting range>,<current setting>)
	Command Send Example	<p>[[V O L ?]] sent from the computer to the projector.</p> <p style="text-align: center;">↓</p> <p>[[0 -3 0 , 1 5]] returned from the projector to the computer.</p>
Write Command	Send Format	(<command name><setting value>)
	Command Send Example	<p>[[V O L 0]] sent from the computer to the projector.</p> <p style="text-align: center;">↓</p> <p>Projector volume setting becomes 0.</p>

- All commands use ASCII characters and decimal format integers.
- The projector will return a question mark (?) when it is sent a command it cannot recognize. Any setting value that cannot be recognized by the projector will be ignored.
- If the projector is performing a process initiated by a previously sent command, a projector key operation, or a remote controller key operation, send of the next command must wait until the projector completes the previous process.

Command List

- While the projector is turned off, it can receive only following commands: check power on/off state (PWR?), read light time (LMP?), and write power on (PWR1). Do not try to send any other commands to the projector while it is turned off.
- Input of a valid signal must be in progress in order to use a command to turn on blank screen or change the aspect ratio.
- You can use only the commands and settings that are equipped on your projector model.
- Entries in the “Function” column of the table below indicate that a command is read-only (**R**) or write only (**W**).

Command Name	Function	Settings
PWR	Power On/Off	0: Off, 1: On
SRC	Selecting the Input Source:	0: RGB1, 1: Component 1, 2: Video, 3: RGB2, 4: Component 2 6: Auto1 (RGB/Component), 7: HDMI1, 8: Network 10: Auto2 (RGB/Component), 13: CASIO USB Tool, 14: HDMI2 15: Templates
AIS	Selecting the Audio Input	0: AUDIO IN, 1: AUDIO IN 1, 2: AUDIO IN 2, 3: AUDIO IN R L 4: HDMI AUDIO IN, 5: HDMI1 AUDIO IN, 6: HDMI2 AUDIO IN 8: Network AUDIO
BLK	Blank Screen	0: Off, 1: On
VOL	Volume*1	0 (mute) to 30 (maximum volume)
VLP	W VLP specifies, as a numeric value, how much volume should be increased. VLM specifies how much it should be decreased. For example, to change volume by a factor of 5, send “VLP5” to increase it or “VLM5” to decrease it.	
VLM		
MUT	Mute	0: Off, 1: On
PST	Color Mode	1: Graphics, 2: Theater, 3: Standard, 4: Blackboard, 5: Natural
ARZ	Aspect Ratio	0: Normal*2, 1: 16:9, 2: Normal*2, 3: Letter Box, 4: Full, 5: True 6: 4:3, 7: 16:10
LMP	R Reads the cumulative light time (Returns the number of hours as an integer value.)	
PMD	Light Control	0: Bright*3, 1: Normal*3, 2: Light Sensor On, 3: Light Output 7 4: Light Output 6, 5: Light Output 5, 6: Light Output 4 7: Light Output 3, 8: Light Output 2, 9: Light Output 1
FRZ	Freeze	0: Off, 1: On
KST	Vertical Keystone Correction	0 to 120*4
KSP	W KSP specifies, as a numeric value, how much vertical keystone correction should be increased. KSM specifies how much it should be decreased. For example, to change vertical keystone correction by a factor of 5, send “KSP5” to increase it or “KSM5” to decrease it.	
KSM		
HKS*5	Horizontal Keystone Correction	0 to 120*4
HKP*5	W HKP specifies, as a numeric value, how much horizontal keystone correction should be increased. HKM specifies how much it should be decreased. For example, to change horizontal keystone correction by a factor of 5, send “HKP5” to increase it or “HKM5” to decrease it.	
HKM*5		
KEY	W Executes key press operation.*6	1: ▲, 2: ▼, 3: ◀, 4: ▶, 5: ENTER, 6: ESC, 10: FUNC, 11: MENU 12: POWER, 13: AUTO, 14: INPUT, 15: TIMER, 16: ASPECT 17: BLANK, 18: FREEZE, 19:  , 20: KEYSTONE + 21: KEYSTONE -, 22: D-ZOOM +, 23: D-ZOOM -, 24: VOLUME + 25: VOLUME -, 31: ID2, 32: ID1, 33: ID4, 34: ID3

Command Name	Function	Settings
POS	Setup Type*7	0: Projection with top of projector upwards, screen in front 1: Projection with top of projector downwards, screen in back 2: Projection with top of projector upwards, screen in back 3: Projection with top of projector downwards, screen in front
APO	Auto Power Off	0: Off, 1: 5 minutes, 2: 10 minutes, 3: 15 minutes, 4: 20 minutes 5: 30 minutes
STS	R Reads the projector error status.	0: Normal, 1: Fan error, 2: Temperature error, 7: Light error 16: Other error
MIC	Microphone Input Level	0 to 3
IDS	Projector ID	0: All, 1: ID1, 2: ID2, 3: ID3, 4: ID4
ALC	RGB1 Level Adjust	0: Off, 1: On
AL2	RGB2 Level Adjust	0: Off, 1: On
ASO	Auto Projection Off	0: Disable, 1: Enable
ASS	Auto Input Search	0: Off, 1: On
TIM	Timer Type	0: Presentation, 1: Countdown
TIT	Countdown Timer Time	0 (0H00M00S) - 35999 (9H59M59S)
TMP*8	Template Type	0: Lines (Large), 1: Lines (Medium), 2: Lines (Small), 3: Grid (Large), 4: Grid (Medium), 5: Grid (Small), 6: Dot Grid (Large), 7: Dot Grid (Small), 8: 2 x 2 Area
MIR	Mirror Mode	0: Off, 1: On
BSN	Board Number R	Shows the board number (page 71).

*1 This setting is applied to the input source signal that is currently being projected by the projector.

*2 Setting 0 is the "Normal" setting when the input source is RGB or HDMI(PC), while setting 2 is the "Normal" setting when the input source is component, HDMI(DTV), or Video.

*3 Light Control Off Mode settings.

*4 The setting range on the projector setup menu is -60 to 60.

*5 XJ-UT Series only

*6 Each KEY command setting corresponds to a remote controller key. The projector operation that is performed in response to a KEY command is identical to the corresponding remote controller key operation. When sending KEY commands to the projector from an external device, make sure they are sent in the same sequence that the corresponding key operations are performed on the remote controller.

*7 Specifies how the projector is set up relative to screen for projection. Corresponds to the projector setup menu "Projection Mode" and "Ceiling Mount" commands.

*8 XJ-UT352W, XJ-F11X, XJ-F101W models only

Specifications

All Series

Display system		DLP® chip × 1, DLP® system
Light Source		Laser and LED
Gamut		Full color (up to 1.07 billion colors)
Contrast Ratio (Full White / Black) *1 *2		20000:1
Scanning Frequencies	Horizontal	15 to 91 kHz
	Vertical	50 to 85 Hz
Display Resolution	Component Signal	Maximum: 1920 × 1080 (HDTV 1080P)
	HDMI Signal	Maximum: 1920 × 1200 resizing
	Video Signal	NTSC, PAL, PAL-N, PAL-M, PAL60, SECAM
Terminals	Digital Video Input	HDMI terminal: HDCP support, audio signal support HDMI type A×1 (XJ-UT312WN) HDMI type A×2 (XJ-UT352W, XJ-UT352WN, XJ-F Series models)
	Analog Video Input	Composite (RCA) terminal × 1
	Audio Input	RCA R/L terminals 3.5 mm stereo mini jack × 2 (XJ-UT Series) 3.5 mm stereo mini jack × 1 (XJ-F Series)
	Audio Output	3.5 mm stereo mini jack × 1
	USB Host	USB type A×2 (XJ-UT312WN, XJ-UT352WN) USB type A×1 (XJ-F211XN, XJ-F211WN)
	USB Device	Micro-USB type B × 1: For firmware update and logo data registration
	Control Terminal	RS-232C (D-sub 9 pin) × 1
	LAN Terminal	RJ-45 × 1 (Network models only)
Wireless Support		IEEE 802.11b/g/n compatible (YW-41 wireless adapter connection is supported by network models only.)
Speaker		16W × 1, Monaural
Operating Temperature		5 to 35°C (41 to 95°F)
Operating Humidity		20 to 80% (non-condensation)
Operating Altitude		0 to 3,000 meters (0 to 10,000 feet) above sea level
Power Requirements		100 to 240V~(AC), 50/60Hz

XJ-UT Series

Model Name		XJ-UT312WN	XJ-UT352W	XJ-UT352WN
Display Chip	Chip Size	WXGA 0.65 inches (Aspect ratio: 16:10)		
	Number of Pixels	1,024,000 (1280 × 800)		
Projection Lens		Fixed zoom, manual focus		
		F 2.3 / f 4.2		
Projected Image Size		50 to 110 inches		
Projection Distance	60 inches	0.13 meters (0.4 feet)		
	100 inches	0.40 meters (1.3 feet)		
	Minimum Projection Distance	0.06 meters (0.2 feet)		
Brightness *1 *2		3100 lumens	3500 lumens	
RGB Signal Display Resolution		Native: 1280 × 800 Maximum: 1920 × 1200 resizing		
Terminals	RGB Input	COMPUTER terminal: RGB 15-pin mini D-Sub × 2 Used for both RGB input and component (YCbCr/YPbPr) input.		
	Component Input			
	RGB Output	MONITOR OUT terminal: RGB 15-pin mini D-Sub × 1		
	Mic Input *3	3.5 mm monaural mini jack × 1		
	USB-A Power Supply Port *4	DC 5V × 1	DC 5V × 1	DC 5V × 1
	USB-A Port	1	-	1
Power Consumption (100 to 240V)				
Light Output 7 when "Light Control" is "On"		160W	185W	
Light Output 1 when "Light Control" is "On"		90W	105W	
When "Bright" is selected for "Light Control Off Mode"		195W	225W	
When "Normal" is selected for "Light Control Off Mode"		170W	200W	
Standby Power Consumption (100 to 120V)				
When "Disable" is specified for "Remote On" *5		0.12W		
When "Enable" is specified for "Remote On" *5		0.6W (Network models only)		
Standby Power Consumption (220 to 240V)				
When "Disable" is specified for "Remote On" *5		0.23W		
When "Enable" is specified for "Remote On" *5		0.8W (Network models only)		
Approximate Dimensions *6		338 (W) × 333 (D) × 153 (H) mm (13.3" × 13.1" × 6") (Including projections)		
Approximate Weight *6		5.8kg (12.8lbs)		

XJ-F Series

Model Name		XJ-F11X	XJ-F21XN	XJ-F101W	XJ-F211WN
Display Chip	Chip Size	XGA 0.55 inches (Aspect ratio: 4:3)		WXGA 0.65 inches (Aspect ratio: 16:10)	
	Number of Pixels	786,432 (1024 × 768)		1,024,000 (1280 × 800)	
Projection Lens		1.5X manual zoom, manual focus			
		F 2.31 to 2.73 / f 18.9 to 27.2			
Projected Image Size		30 to 300 inches		35 to 300 inches	
Projection Distance	60 inches	1.95 to 2.87 meters (6.4 to 9.4 feet)		1.64 to 2.42 meters (5.4 to 7.9 feet)	
	100 inches	3.33 to 4.85 meters (10.9 to 15.9 feet)		2.81 to 4.11 meters (9.2 to 13.5 feet)	
	Minimum Projection Distance	0.93 meters (3.1 feet)		0.92 meters (3.0 feet)	
Brightness *1 *2		3300 lumens		3500 lumens	
RGB Signal Display Resolution		Native: 1024 × 768		Native: 1280 × 800	
		Maximum: 1920 × 1200 resizing			
Terminals	RGB Input	COMPUTER terminal: RGB 15-pin mini D-Sub × 1 Used for both RGB input and component (YCbCr/YPbPr) input.			
	Component Input				
	Mic Input *3	3.5 mm monaural mini jack × 1 (Network models only)			
	USB-A Power Supply Port *4	DC 5V × 1	DC 5V × 1	DC 5V × 1	DC 5V × 1
	USB-A Port	–	1	–	1
Power Consumption (100 to 240V)					
Light Output 7 when “Light Control” is “On”		160W		165W	
Light Output 1 when “Light Control” is “On”		80W		85W	
When “Bright” is selected for “Light Control Off Mode”		195W		205W	
When “Normal” is selected for “Light Control Off Mode”		170W		175W	
Standby Power Consumption (100 to 120V)					
When “Disable” is specified for “Remote On” *5		0.12W			
When “Enable” is specified for “Remote On” *5		0.6W (Network models only)			

Model Name	XJ-F11X	XJ-F21XN	XJ-F101W	XJ-F211WN
Standby Power Consumption (220 to 240V)				
When "Disable" is specified for "Remote On" *5	0.23W			
When "Enable" is specified for "Remote On" *5	0.8W (Network models only)			
Approximate Dimensions	299 (W) × 299 (D) × 97 (H) mm (11.8" × 11.8" × 3.8") (Including projections)			
Approximate Weight	3.8kg (8.4lbs)			

*1 When the "Light Control Off Mode" setting is "Bright". ISO 21118:2012 standard.

*2 Shows overall average value when the projector is shipped from the factory. This type of entry is governed by ISO 21118:2012 data projector specifications. Measurement methods and conditions are based on Appendix B.

*3 Plug-in power type microphones are not supported.

*4 With a network model, the USB Host port also serves as a USB power supply port.

*5 For information about configuring the Remote On setting, see "Network Settings → Network Settings → Remote On" (page 62).

*6 Excluding cable cover.

Specifications are subject to change without notice.

TCO Certified Document URL

<https://world.casio.com/projector/tco/>

GUIDELINES LAID DOWN BY FCC RULES FOR USE OF THIS UNIT IN THE U.S.A. (not applicable to other areas).

NOTICE

This equipment has been tested and found to comply with the limits for a Class B digital device, pursuant to Part 15 of the FCC Rules. These limits are designed to provide reasonable protection against harmful interference in a residential installation. This equipment generates uses and can radiate radio frequency energy and, if not installed and used in accordance with the instructions, may cause harmful interference to radio communication. However, there is no guarantee that interference will not occur in a particular installation. If this equipment does cause harmful interference to radio or television reception, which can be determined by turning the equipment off and on, the user is encouraged to try to correct the interference by one or more of the following measures:

- Reorient or relocate the receiving antenna.
- Increase the separation between the equipment and receiver.
- Connect the equipment into an outlet on a circuit different from that to which the receiver is connected.
- Consult the dealer or an experienced radio/TV technician for help.

FCC CAUTION

Changes or modifications not expressly approved by the party responsible for compliance could void the user's authority to operate the equipment.

Proper connectors must be used for connection to host computer and/or peripherals in order to meet FCC emission limits.

Connector cable....XJ-UT312WN/XJ-UT352W/XJ-UT352WN/XJ-F11X/XJ-F21XN/XJ-F101W/XJ-F211WN
unit to PC

Declaration of Conformity

Model Number: XJ-UT312WN/XJ-UT352W/XJ-UT352WN/XJ-F11X/XJ-F21XN/XJ-F101W/XJ-F211WN

Trade Name: CASIO COMPUTER CO., LTD.

Responsible party: CASIO AMERICA, INC.

Address: 570 MT. PLEASANT AVENUE, DOVER, NEW JERSEY 07801

Telephone number: 973-361-5400

This device complies with Part 15 of the FCC Rules, Operation is subject to the following two conditions:

(1) This device may not cause harmful interference, and (2) this device must accept any interference received, including interference that may cause undesired operation.



CASIO COMPUTER CO., LTD.

XJ-UT312WN/XJ-UT352W/

XJ-UT352WN/XJ-F11X/XJ-F21XN/

XJ-F101W/XJ-F211WN

FOR CALIFORNIA USA ONLY

Perchlorate Material – special handling may apply.

See www.dtsc.ca.gov/hazardouswaste/perchlorate.

This Class B digital apparatus complies with Canadian ICES-003.

Cet appareil numérique de la classe B est conforme à la norme NMB-003 du Canada.

GPL and LGPL

- (1) This product uses software (This Software) that comes under the GNU General Public License (GPL) and GNU Lesser General Public License (LGPL). In accordance with the GPL and LGPL, the source code of This Software is open source code. Anyone who wishes to view the open source code can do so by downloading it from the CASIO Projector download site. Whenever copying, modifying, or distributing This Software, be sure to do so in accordance with the terms and conditions of the GPL and LGPL.
- (2) This Software is provided “as is” without expressed or implied warranty of any kind. However, this disclaimer does not affect the terms and conditions of the warranty of the product itself (including malfunctions due to This Software).
- (3) For details about the GPL and LGPL that This Software comes under, visit the CASIO website.

HDMI™
HIGH-DEFINITION MULTIMEDIA INTERFACE



Manufacturer:
CASIO COMPUTER CO., LTD.
6-2, Hon-machi 1-chome, Shibuya-ku, Tokyo 151-8543, Japan
Responsible within the European Union:
Casio Europe GmbH
Casio-Platz 1, 22848 Norderstedt, Germany
www.casio-europe.com

CASIO®

CASIO COMPUTER CO., LTD.
6-2, Hon-machi 1-chome
Shibuya-ku, Tokyo 151-8543, Japan

MA1901-A

© 2019 CASIO COMPUTER CO., LTD.