

LABORATORY EQUIPMENT

Product catalogue

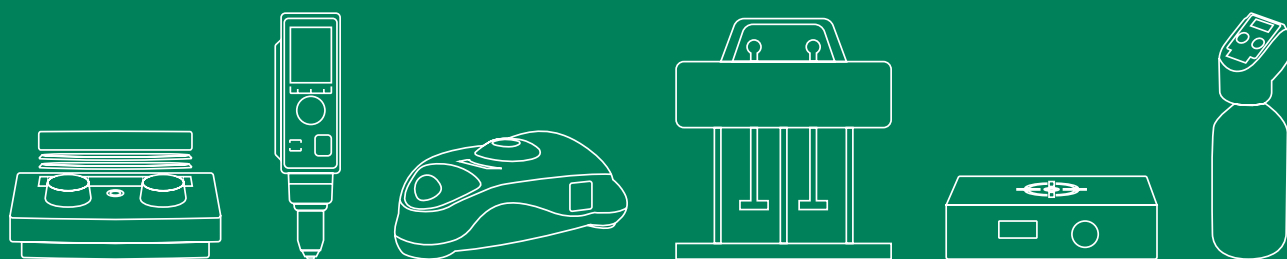

VELP Scientifica

Established in 1983, VELP Scientifica is today one of the world's leading manufacturers of analytical instruments and laboratory equipment that has made an impact on the world-wide market with Italian products renowned for innovation, design and premium connectivity.

We owe our success to a rich patrimony of ideas, significant investments in R&D and technological development aiming at maximizing productivity as well as reducing time-to-market.

VELP is a pioneer of smart lab technology. Our analytical instruments and laboratory equipment are accelerating scientific work every day giving scientists the possibility to monitor and control VELP technology from a virtual dashboard accessible from any device, everywhere and anytime!

VELP is today a global company with an expanding local focus. Our internationalization process has led us to open local subsidiaries that provide service to our customers in different parts of the world:

- **VELP Scientific, Inc.** in Long Island (USA) offering sales and technical support for the United States, Canada, and Mexico.
- **VELP China Co. LTD** in Shanghai guarantees a local presence in China through commercial and technical support.

VELP has always generated value for its customers through close cooperation with its qualified distribution network which today counts more than 300 distributors in 130 countries.

Product Overview

VELP Ermes

- SMART LAB CLOUD PLATFORM 7
- VELP ERMES SUBSCRIPTIONS 7

Magnetic Stirrers

- MSL 50 Digital 8
- MSL 25 Digital 8
- MSL 8 Digital 9
- MSL 8 9
- MST Digital 10
- MST 10
- MICROSTIRRER 11
- ESP 11
- MULTISTIRRER 15 Digital 12
- MULTISTIRRER 6 Digital 12
- MULTISTIRRER 15 13
- MULTISTIRRER 6 13
- AMI 14
- AMI 4 14

Heating Magnetic Stirrers

- AREX-6 Connect PRO 16
- AREX-6 Digital PRO 17
- AREX-6 18
- ARE-6 19
- AREX Digital PRO 20
- AREX 21
- ARE 22
- AM4 Digital PRO 23
- AM4 24
- AREC Connect 27
- AREC.X 28
- AREC 29
- HSC 29
- MULTI-HS 15 Digital 31
- MULTI-HS 6 Digital 32
- VTF 33

Heating Plates

▪ RC	34
▪ RC2	34
▪ REC	35

Overhead Stirrers

▪ OHS 200 Advance	37
▪ OHS 100 Advance	37
▪ OHS 60 Advance	38
▪ OHS 200 Digital	38
▪ OHS 100 Digital	39
▪ OHS 60 Digital	39
▪ OHS 40 Digital	40
▪ OHS 20 Digital	40
▪ DLH	41
▪ DLS	41
▪ PW	42
▪ LH	42
▪ LS	43
▪ ES	43
▪ CONTROLLER Advance	46
▪ CONTROLLER Digital	46

Vortex Mixers

▪ Wizard IR	47
▪ Classic	47
▪ TX4	48
▪ ZX4	48
▪ ZX3	49
▪ RX3	49
▪ MULTI-TX5	51

Homogenizer

▪ OV5	52
-------	----

COD Thermoreactors

▪ ECO 16	54
▪ ECO 6	54
▪ ECO 25	55
▪ ECO 8	55

BOD and Respirometers

▪ RESPIROMETRIC Sensor System 6 BOD	57
▪ RESPIROMETRIC Sensor System 6 Maxi BMP	57
▪ RESPIROMETRIC Sensor System 6 for Soil Analysis	58
▪ RESPIROMETRIC Sensor System 6 for Plastic Biodegradability	58
▪ BOD Sensor	59
▪ BOD Sensor System 6	59
▪ BOD Sensor System 10	60

Cooled Incubators

▪ FOC 200IL Connect	61
▪ FOC 200I Connect	61
▪ FOC 200E Connect	62
▪ FOC 120I Connect	62
▪ FOC 120E Connect	63
▪ FTC 120	63

Flocculators

▪ JLT 6	65
▪ JLT 4	65
▪ FC6S	66
▪ FC4S	66
▪ FP4	67

Other Solutions

▪ ROTAX 6.8 Overhead Mixer	68
▪ OCB Open Circulating Baths	68
▪ Radiation Detector	69
▪ SP 311 Peristaltic Pumps	69
▪ TB1 Turbidimeter	70
▪ JPV Recirculating Water Vacuum Pump	70

VELP Ermes

■ SMART LAB CLOUD PLATFORM

VELP Ermes creates a connected ecosystem of devices, people and data that transmit information between each other cutting down distances and expanding your scientific potential.

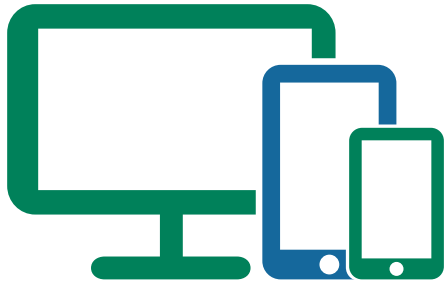

Monitor and Control your instruments

Monitor and manage multiple instruments 24/7 from your internet devices. Real-time visualization of your analysis and of the instruments working conditions and get immediate notifications and alerts.



Remote Service Support

Thanks to the direct contact with VELP specialists and official partners, VELP Ermes can guide you to get the maximum from your instruments.

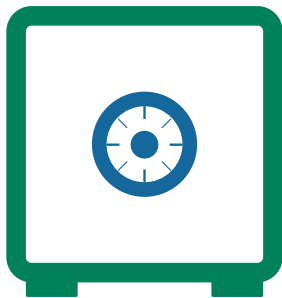

Safely Manage your Data

Collect and store your data with the maximum level of encryption and cyber-security standards. Generate and share reports of your analysis in multiple formats.

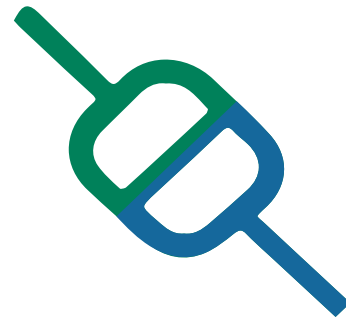

Your Instruments are Always Updated

Effortlessly connect your instrument via secure Wi-Fi or cable and update the software immediately free of charge.

■ VELP ERMES SUBSCRIPTIONS

Configure your account and your instruments and start enjoying all the services and capabilities of VELP Ermes for free for 3 months. Decide later whether to extend your subscription with an Ermes Card for 1 or 3 years. Each Ermes Card allows you to connect up to 10 instruments in your company.



3
MONTHS
FREE TRIAL

FREE TRIAL
3 MONTHS PER INSTRUMENT

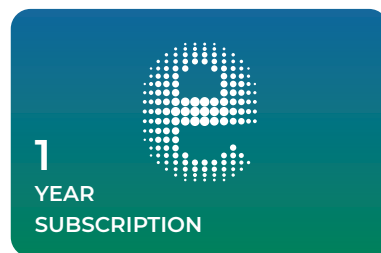

1
YEAR
SUBSCRIPTION

1 YEAR / 10 INSTRUMENTS
Code E00010012

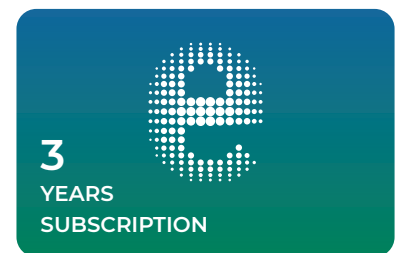

3
YEARS
SUBSCRIPTION

3 YEARS / 10 INSTRUMENTS
Code E00010036

Magnetic Stirrers

■ MSL 50 Digital

High volume magnetic stirrer with digital display to accurately set the working conditions. Programmable operations with the integrated timer and auto-reverse. Main applications of MSL 50 Digital are high volumes preparations, cell cultures and tissue cultures, buffer solution preparations.

PRECISE AND PROGRAMMABLE

SpeedServo™ technology maintains constant speed. Unattended stirring from 1 minute to 99 h 59 minutes.

ROBUST AND VERSATILE

The brushless motor provides continuous operation for high volumes at any speed. Robust stainless steel top for easy visualization of color changes and particles.



Volume (H₂O)
50 L



Stirring speed
From 20 to 1000 rpm



Timer &
Auto-reverse



Safety Lock

INSTRUMENT - CODE

MSL 50 Digital

100±240 V / 50-60 Hz

F203A0512



■ MSL 25 Digital

High volume magnetic stirrer with digital display to accurately set the working conditions. Programmable operations with the integrated timer and auto-reverse. Main applications of MSL 25 Digital are high volumes preparations, cell cultures and tissue cultures, buffer solution preparations.

PRECISE AND PROGRAMMABLE

SpeedServo™ technology maintains constant speed. Unattended stirring from 1 minute to 99 h 59 minutes.

ROBUST AND VERSATILE

The brushless motor provides continuous operation for high volumes at any speed. Robust stainless steel top for easy visualization of color changes and particles.



Volume (H₂O)
25 L



Stirring speed
From 40 to 1500 rpm



Timer &
Auto-reverse



Safety Lock

INSTRUMENT - CODE

MSL 25 Digital

100±240 V / 50-60 Hz

F203A0511



■ MSL 8 Digital

High volume magnetic stirrer with digital display to accurately set the working conditions. Programmable operations with the integrated timer and auto-reverse. Main applications of MSL 8 Digital are high volumes preparations, cell cultures and tissue cultures, buffer solution preparations.

PRECISE AND PROGRAMMABLE

SpeedServo™ technology maintains constant speed. Unattended stirring from 1 minute to 99 h 59 minutes.

ROBUST AND VERSATILE

The brushless motor provides continuous operation for high volumes at any speed. Robust stainless steel top for easy visualization of color changes and particles.



Volume (H₂O)
8 L



Stirring speed
From 40 to 1500 rpm



Timer &
Auto-reverse



Safety Lock

INSTRUMENT - CODE

MSL 8 Digital

100÷240 V / 50-60 Hz

F203A0510



■ MSL 8

Magnetic stirrer guaranteeing continuous operations at any speed ensuring safety and resistance to chemical agents. MSL 8 has a gentle start in order to protect the sample. The control panel is protected from liquid spills.

PRECISE

SpeedServo™ technology maintains constant speed.

ROBUST AND VERSATILE

The brushless motor provides continuous operation for high volumes at any speed. Robust stainless steel top for easy visualization of color changes and particles.



Volume (H₂O)
8 L



Stirring speed
From 40 to 1500 rpm

INSTRUMENT - CODE

MSL 8

100÷240 V / 50-60 Hz

F203A0513



MST Digital

Compact magnetic stirrer with digital display with accurate speed setting, timer and auto-reverse. The white surface is designed to facilitate the visualization of particles and color change. MST Digital allows continuous operation and remains cold even after days of continuous use. Main applications in microbiology, biochemistry and chemistry.

PRECISE AND PROGRAMMABLE

SpeedServo™ technology maintains constant speed. Unattended stirring from 1 to 900 minutes.

POWERFUL

Equipped with a powerful brushless motor.



Volume (H₂O)
5 L



Stirring speed
Up to 1500 rpm



Timer &
Auto-reverse



Safety Lock



INSTRUMENT - CODE

MST Digital

100±240 V / 50-60 Hz

F203A0450



MST

Powerful and compact magnetic stirrer with a low profile. The white surface is designed to facilitate the visualization of particles and color change. MST Digital allows continuous operation and remains cold even after days of continuous use. Main applications in microbiology, biochemistry and chemistry.

RESISTANT

The technopolymer structure ensures maximum resistance to chemicals.



Volume (H₂O)
5 L



Stirring speed
Up to 1100 rpm



INSTRUMENT - CODE

MST

100±240 V / 50-60 Hz

F203A0440



■ MICROSTIRRER

Compact and light weight magnetic stirrer with metal structure for visualization of particles and color changes. Specially designed for microtitrations.

RELIABLE

It remains cold, even after days of continuous use and guarantees excellent speed control, even at low speed.



Volume (H₂O)
5 L



Stirring speed
Up to 1100 rpm

INSTRUMENT - CODE

MICROSTIRRER

100÷240 V / 50-60 Hz

F203A0161



■ ESP

Flat and light weight magnetic stirrer with no moving mechanical components: it is therefore maintenance-free. The clear surface is ideal for visualization of particles and color changes.

RESISTANT

The control panel is protected from liquid spills with run-off groove and the technopolymer casing resists chemicals.



Volume (H₂O)
5 L



Stirring speed
Up to 1100 rpm

INSTRUMENT - CODE

ESP

100÷240 V / 50-60 Hz

F206A0179



MULTISTIRRER 15 Digital

Multi position magnetic stirrer with stainless steel top for the simultaneous stirring of 15 positions. A bright digital display to accurately set the stirring speed, timer, and auto-reverse. Ideal for chemistry, microbiology, biochemistry applications.

PRECISE AND PROGRAMMABLE

SpeedServo™ technology maintains constant speed. Unattended stirring from 1 to 900 minutes.

RESISTANT

Stainless steel top plate. The control panel is shielded from liquid spills.



Volume (H₂O)
250 ml (x15)



Stirring speed
From 80 to 1500 rpm



Timer &
Auto-reverse



Safety Lock

INSTRUMENT - CODE

MULTISTIRRER 15 Digital

100±240 V / 50-60 Hz

F203A0180



MULTISTIRRER 6 Digital

Multi position magnetic stirrer with stainless steel top for the simultaneous stirring of 6 positions. A bright digital display to accurately set the stirring speed, timer, and auto-reverse. Ideal for chemistry, microbiology, biochemistry applications.

PRECISE AND PROGRAMMABLE

SpeedServo™ technology maintains constant speed. Unattended stirring from 1 to 900 minutes.

RESISTANT

Stainless steel top plate. The control panel is shielded from liquid spills.



Volume (H₂O)
400 ml (x6)



Stirring speed
From 80 to 1500 rpm



Timer &
Auto-reverse



Safety Lock

INSTRUMENT - CODE

MULTISTIRRER 6 Digital

100±240 V / 50-60 Hz

F203A0179



MULTISTIRRER 15

Multi position magnetic stirrer with stainless steel top for the simultaneous stirring of 15 positions. Pale surface for visualization of particles and color changes. Remains cold, even after days of continuous use. Ideal for chemistry, microbiology, biochemistry applications.

PRECISE

SpeedServo™ technology maintains constant speed.

RESISTANT

Stainless steel top plate. The control panel is shielded from liquid spills.



Volume (H₂O)
250 ml (x15)



Stirring speed
From 80 to 1500 rpm

INSTRUMENT - CODE

MULTISTIRRER 15

100÷240 V / 50-60 Hz

F203A0178



MULTISTIRRER 6

Multi position magnetic stirrer with stainless steel top for the simultaneous stirring of 6 positions. Pale surface for visualization of particles and color changes. Remains cold, even after days of continuous use. Ideal for chemistry, microbiology, biochemistry applications.

PRECISE

SpeedServo™ technology maintains constant speed.

RESISTANT

Stainless steel top plate. The control panel is shielded from liquid spills.



Volume (H₂O)
400 ml (x6)



Stirring speed
From 80 to 1500 rpm

INSTRUMENT - CODE

MULTISTIRRER 6

100÷240 V / 50-60 Hz

F203A0177



■ AMI

Illuminated magnetic stirrer particularly useful for titrations. The illuminated surface facilitates the visualization of particles and color changes. It guarantees excellent speed control (electronic), even at low speed.

RESISTANT

Epoxy-coated tough steel casing and stainless steel cover. The control panel is shielded from liquid spills

RELIABLE

It remains cold, even after days of continuous use and is equipped with a pale surface for visualization of particles and color changes.

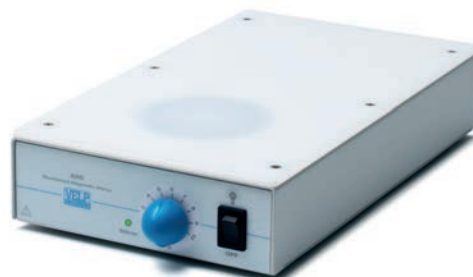

Volume (H₂O)
5 L



Stirring speed
Up to 1100 rpm



LED

INSTRUMENT - CODE

AMI

100÷240 V / 50-60 Hz

F204A0167



■ AMI 4

Illuminated multi-position magnetic stirrer particularly useful for titrations. The illuminated surface facilitates the visualization of particles and color changes. It guarantees excellent speed control (electronic), even at low speed.

RESISTANT

Epoxy-coated tough steel casing and stainless steel cover. The control panel is shielded from liquid spills

RELIABLE

It remains cold, even after days of continuous use and is equipped with a pale surface for visualization of particles and color changes.

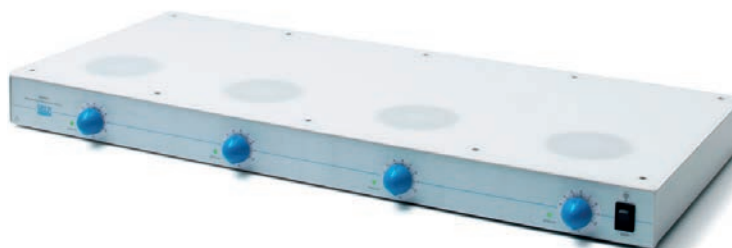

Volume (H₂O)
5 L (x4)



Stirring speed
Up to 1100 rpm



LED

INSTRUMENT - CODE

AMI 4

100÷240 V / 50-60 Hz

F204A0168



ACCESSORIES - MAGNETIC STIRRERS

	MST	MST Digital	MICRO-STIRRER	ESP	MSL 8	MSL 8 Digital	MSL 25 Digital	MSL 50 Digital	AMI	AMI 4	MULTI-STIRRER	MULTI-STIRRER Digital
A00001057 Magnetic stir bar, Ø 6x20 mm	•	•	•						•	•	•	•
A00001056 Magnetic stir bar, Ø 6x35 mm	•	•	•		•	•			•	•	•	•
A00001061 Magnetic stir bar, Ø 9,5x60mm								•				
A00000356 Magnetic stir bar, Ø 8x40 mm				•	•	•						
A00000387 Magnetic stir bar, Ø 8x50 mm							•					
A00001055 Thermostatic bath for samples, 280x180x410 mm											•	•
10003083 Plug USA for power supply	•	•	•	•	•	•	•	•	•	•	•	•
10003084 Plug UK for power supply	•	•	•	•	•	•	•	•	•	•	•	•
10003085 Plug AU for power supply	•	•	•	•	•	•	•	•	•	•	•	•



Heating Magnetic Stirrers

■ AREX-6 Connect PRO

Digital hot plate stirrer that connects effortlessly to the VELP Ermes cloud platform via secure Wi-Fi allowing monitoring and control of the reactions at any time. The white LED display and a set of icons provide precise settings and clear readout of the working conditions. The fast heating, 135 mm diameter CerAlTop™ plate protects from chemicals, scratches and enhances the lifetime of the unit.

SAFETY AND DURABILITY

Two independent safety circuits protect the instrument in case of over-temperature, switching-off the heating. IP42 certified.

STATE-OF-THE-ART THERMOREGULATION

Extremely stable and fast thermoregulation with minimal overshoot thanks to the PID thermoregulation software.

SUPERIOR PERFORMANCES

Brushless motor and Alnico Magnet provide state-of-the-art stirring performance.



ermes enabled



Volume (H₂O)
20 L



Stirring speed
From 30 to 1700 rpm



Temperature range
From room temperature
to 370 °C



Timer &
Auto-reverse



Safety Lock



External connection
Pt 100 Probe

CONFIGURATIONS - AREX-6 Connect PRO



AREX-6 Connect PRO System
with Temperature Probe

AREX-6 Connect PRO System with
Temperature Probe, Rod and Clamp

INSTRUMENT - CODE

AREX-6 Connect PRO with Temperature Probe	230 V / 50-60 Hz	SA20500465
AREX-6 Connect PRO with Temperature Probe	115 V / 60 Hz	SA20510465
AREX-6 Connect PRO with Temperature Probe, Rod and Clamp	230 V / 50-60 Hz	SB20500465
AREX-6 Connect PRO with Temperature Probe, Rod and Clamp	115 V / 60 Hz	SB20510465



■ AREX-6 Digital PRO

Digital hot plate stirrer with white LED display and a set of icons providing precise settings and clear readout of the working conditions. The fast heating, 135 mm diameter CerAlTop™ plate protects from chemicals, scratches and enhances the lifetime of the unit. Enhanced kinetics and programmable operations thanks to to integrated timer and auto-reverse.

SAFETY AND DURABILITY

Two independent safety circuits protect the instrument in case of over-temperature, switching-off the heating. IP42 certified.







STATE-OF-THE-ART THERMOREGULATION

Extremely stable and fast thermoregulation with minimal overshoot thanks to the PID thermoregulation software.

SUPERIOR PERFORMANCES

Brushless motor and Alnico Magnet provide state-of-the-art stirring performance.



			
Volume (H ₂ O) 20 L	Stirring speed From 30 to 1700 rpm	Temperature range From room temperature to 370 °C	
			
Timer & Auto-reverse	Safety Lock	External connection Pt 100 Probe	External connection VTF

CONFIGURATIONS - AREX-6 Digital PRO

		
AREX-6 Digital PRO System with Temperature Probe	AREX-6 Digital PRO System with Temperature Probe, Rod and clamp	AREX-6 Digital PRO System with VTF Thermoregulator

INSTRUMENT - CODE

AREX-6 Digital PRO with Temperature Probe	230 V / 50-60 Hz	SA20500460
AREX-6 Digital PRO with Temperature Probe	115 V / 60 Hz	SA20510460
AREX-6 Digital PRO with Temperature Probe, Rod and Clamp	230 V / 50-60 Hz	SD20500460
AREX-6 Digital PRO with Temperature Probe, Rod and Clamp	115 V / 60 Hz	SD20510460
AREX-6 Digital PRO with VTF	230 V / 50-60 Hz	SB20500460
AREX-6 Digital PRO with VTF	115 V / 60 Hz	SB20510460



■ AREX-6

Safe and powerful hot plate stirrer with 135 mm diameter CerAlTop™ plate that protects from chemicals, scratches and enhances the lifetime of the unit. Combinable with VTF for accurate thermoregulation of the sample $\pm 0.5^\circ\text{C}$.

SAFETY AND DURABILITY

The illuminated heating switch on/off prevents unintentional heat up and the illuminated heat icon informs the operator when the top plate temperature is above 50°C .

SUPERIOR PERFORMANCES

Brushless motor and Alnico Magnet provide state-of-the-art stirring performance.



Volume (H₂O)
20 L



Stirring speed
From 30 to 1700 rpm



Temperature range
From room temperature
to 370°C



External connection
VTF

CONFIGURATIONS - AREX-6



AREX-6

AREX-6 System with
VTF Thermoregulator

INSTRUMENT - CODE

AREX-6	230 V / 50-60 Hz	F20500463
AREX-6	115 V / 60 Hz	F20510463
AREX-6 with VTF	230 V / 50-60 Hz	SA20500463
AREX-6 with VTF	115 V / 60 Hz	SA20510463



■ ARE-6

Safe and powerful hot plate stirrer with 135 mm diameter aluminium plate. Precise analog knobs to control speed and plate temperature with the maximum ease-of-use.

SAFETY AND DURABILITY

The illuminated heating switch on/off prevents unintentional heat up and the illuminated heat icon informs the operator when the top plate temperature is above 50 °C.

SUPERIOR PERFORMANCES

Brushless motor and Alnico Magnet provide state-of-the-art stirring performance.



Volume (H₂O)
20 L



Stirring speed
From 30 to 1700 rpm



Temperature range
From room temperature
to 370 °C

INSTRUMENT - CODE

ARE-6	230 V / 50-60 Hz	F20500462
ARE-6	115 V / 60 Hz	F20510462

ACCESSORIES - ARE/AREX-6 Series



	AREX-6 CONNECT PRO	AREX-6 Digital PRO	AREX-6	ARE-6
A00001062 Magnetic stir bar, Ø 3x6 mm	•	•	•	•
A00001063 Magnetic stir bar, Ø 4,5x12 mm	•	•	•	•
A00001057 Magnetic stir bar, Ø 6x20 mm	•	•	•	•
A00001056 Magnetic stir bar, Ø 6x35 mm	•	•	•	•
A00000356 Magnetic stir bar, Ø 8x40 mm	•	•	•	•
A00001061 Magnetic stir bar, Ø 10x60 mm	•	•	•	•
A00000336 Magnetic cross shape stir bar, Ø 10x5 mm	•	•	•	•
A00000352 Magnetic cross shape stir bar, Ø 20x8 mm	•	•	•	•
A00000354 Magnetic disc stir bar, Ø 10x6 mm	•	•	•	•
A00000355 Magnetic disc stir bar, Ø 20x10 mm	•	•	•	•
A00000357 Magnetic octagonal stir bar, Ø 10x13 mm	•	•	•	•
A00000268 Temperature Probe AISI 316 Ti Ø 3 mm	•	•		
A00000349 Temperature probe glass-coated Ø 5 mm	•	•		
F208B0063 VTF Digital Thermoregulator		•	•	
A00000382 Extension for support rod	•	•	•	•
A00000280 Clamp for the probe	•	•		
A00000351 Handle for AluBlock removal	•	•	•	•
A00001069 Support rod	•	•	•	•
E00010012 VELP Ermes 1 years Connection	•			
E00010036 VELP Ermes 3 years Connection	•			

■ AREX Digital PRO

Digital hot plate stirrer ensuring precise settings and clear readout of the working conditions. The fast heating, 135 mm diameter CerAlTop™ plate protects from chemicals, scratches and enhances the lifetime of the unit.

SAFETY AND DURABILITY

The control panel is protected against possible damage caused by liquid spills thanks to a dedicated run-off groove. IP 42 certified.

PRECISE THERMOREGULATION

Excellent thermoregulation performance with Pt100 Probe and VTF.



Volume (H₂O)
20 L



Stirring speed
Up to 1500 rpm



Temperature range
From room temperature
to 370 °C



Timer



External connection
Pt 100 Probe



External connection
VTF

CONFIGURATIONS - AREX Digital PRO



AREX Digital PRO System with
Temperature Probe

AREX Digital PRO System with
Temperature Probe, Rod and clamp

AREX Digital PRO System with
VTF Thermoregulator

INSTRUMENT - CODE

AREX Digital PRO with Temperature Probe	230 V / 50-60 Hz	SA20500410
AREX Digital PRO with Temperature Probe	115 V / 60 Hz	SA20510410
AREX Digital PRO with Temperature Probe, Rod and Clamp	230 V / 50-60 Hz	SC20500410
AREX Digital PRO with Temperature Probe, Rod and Clamp	115 V / 60 Hz	SC20510410
AREX Digital PRO with VTF	230 V / 50-60 Hz	SB20500410
AREX Digital PRO with VTF	115 V / 60 Hz	SB20510410



■ AREX

Reliable hot plate stirrer with 135 mm diameter CerAlTop™ plate that protects from chemicals, scratches and enhances the lifetime of the unit. Combinable with VTF for accurate thermoregulation of the sample ± 0.5 °C.

SAFETY AND DURABILITY

The control panel is protected against possible damage caused by liquid spills thanks to a dedicated run-off groove. IP 42 certified.

PRECISE THERMOREGULATION

Excellent thermoregulation performance with VTF.



Volume (H₂O)
20 L



Stirring speed
Up to 1500 rpm



Temperature range
From room temperature
to 370 °C



External connection
VTF

CONFIGURATIONS - AREX



AREX

AREX System with
VTF Thermoregulator

INSTRUMENT - CODE

AREX	230 V / 50-60 Hz	F20500413
AREX	115 V / 60 Hz	F20510413
AREX with VTF	230 V / 50-60 Hz	SA20500413
AREX with VTF	115 V / 60 Hz	SA20510413



■ ARE

Hot plate stirrer with SpeedServo™ that ensures constant speed even when the viscosity changes. ARE guarantees an excellent speed control and it is widely used in research and development, industrial and university laboratories worldwide.

DURABLE

The ARE is IP42 certified and thanks to the resistant die-cast housing and the run-off groove all the internal parts of the instrument are protected from potential damages.

RELIABLE

Aluminum alloy top plate (135 mm diameter) ensures a great temperature homogeneity and optimum heat transfer across the entire surface.



Volume (H₂O)
15 L



Stirring speed
Up to 1500 rpm



Temperature range
From room temperature
to 370 °C

INSTRUMENT - CODE

ARE	230 V / 50-60 Hz	F20500162
ARE	115 V / 60 Hz	F20510162



ACCESSORIES - ARE-AREX Series

	AREX Digital PRO	AREX	ARE
A00001062 Magnetic stir bar, Ø 3x6 mm	•	•	•
A00001063 Magnetic stir bar, Ø 4,5x12 mm	•	•	•
A00001057 Magnetic stir bar, Ø 6x20 mm	•	•	•
A00001056 Magnetic stir bar, Ø 6x35 mm	•	•	•
A00000356 Magnetic stir bar, Ø 8x40 mm	•	•	•
A00001061 Magnetic stir bar, Ø 10x60 mm	•	•	•
A00000336 Magnetic cross shape stir bar, Ø 10x5 mm	•	•	•
A00000352 Magnetic cross shape stir bar, Ø 20x8 mm	•	•	•
A00000354 Magnetic disc stir bar, Ø 10x6 mm	•	•	•
A00000268 Temperature Probe AISI 316 Ti Ø 3 mm	•		
A00000349 Temperature probe glass-coated Ø 5 mm	•		
F208B0063 VTF Digital Thermoregulator	•	•	
A00000382 Extension for support rod	•	•	•
A00000280 Clamp for the probe	•	•	
A00000351 Handle for AluBlock removal	•	•	•
A00001069 Support rod	•	•	•

■ AM4 Digital PRO

AM4 Digital Pro multi-position digital magnetic stirrer to manage in parallel four heating plates independently, up to a volume of 20 L each. SpeedServo™ system ensures constant speed even when the viscosity changes. The 135 mm diameter CerAlTop™ plates, made of aluminum alloy coated with ceramic, ensures an outstanding temperature homogeneity over the entire surface, optimum resistance to chemical agents and easy cleaning.

SAFETY AND DURABILITY

The control panel is protected against possible damage caused by liquid spills.

PRECISE THERMOREGULATION

Excellent thermoregulation performance with Pt100 Probe and VTF.



Volume (H₂O)
20 L (x4)



Stirring speed
From 50 to 1500 rpm



Temperature range
From room temperature
to 370 °C



External connection
Pt 100 Probe



External connection
VTF

CONFIGURATIONS - AM4 Digital PRO

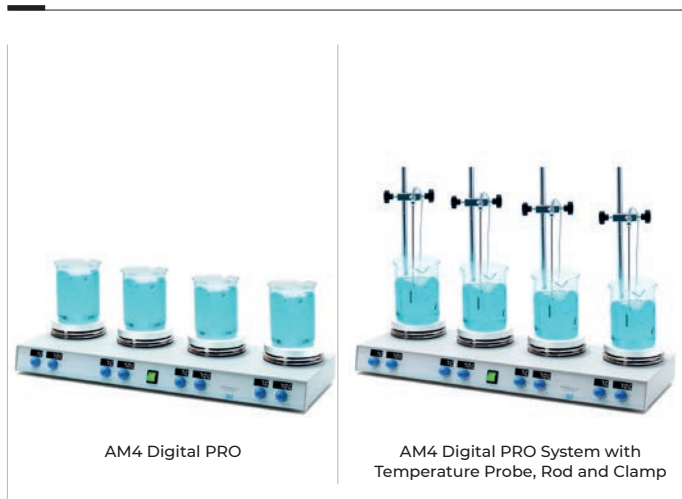

AM4 Digital PRO

AM4 Digital PRO System with
Temperature Probe, Rod and Clamp

INSTRUMENT - CODE

AM4 Digital PRO	230 V / 50-60 Hz	F20500425
AM4 Digital PRO with Temperature Probe, Rod and Clamp	230 V / 50-60 Hz	SA20500425



AM4

AM4 multi-position hot plate stirrer with four separately controlled stirring plates (186 mm between them) that guarantees excellent speed control and resistance to chemicals. SpeedServo™ technology ensures constant speed even when the viscosity changes.

RELIABLE

Aluminum alloy top plate (135 mm diameter) ensures a great temperature homogeneity and optimum heat transfer across the entire surface.



Volume (H₂O)
15 L (x4)



Stirring speed
Up to 1500 rpm



Temperature range
From room temperature
to 370 °C

INSTRUMENT - CODE

AM4

230 V / 50-60 Hz

F20500420



ACCESSORIES - AM4 Series

	AM4 Digital PRO	AM4
A00001062 Magnetic stir bar, Ø 3x6 mm	•	•
A00001063 Magnetic stir bar, Ø 4,5x12 mm	•	•
A00001057 Magnetic stir bar, Ø 6x20 mm	•	•
A00001056 Magnetic stir bar, Ø 6x35 mm	•	•
A00000356 Magnetic stir bar, Ø 8x40 mm	•	•
A00001061 Magnetic stir bar, Ø 10x60 mm	•	•
A00000336 Magnetic cross shape stir bar, Ø 10x5 mm	•	•
A00000352 Magnetic cross shape stir bar, Ø 20x8 mm	•	•
A00000354 Magnetic disc stir bar, Ø 10x6 mm	•	•
A00000355 Magnetic disc stir bar, Ø 20x10 mm	•	•
A00000268 Temperature Probe AISI 316 Ti Ø 3 mm	•	•
A00000349 Temperature probe glass-coated Ø 5 mm	•	•
F208B0063 VTF Digital Thermoregulator	•	•
A00000382 Extension for support rod	•	•
A00000280 Clamp for the probe	•	•
A00000351 Handle for AluBlock removal	•	•
A00001069 Support rod	•	•

PTFE SAFETY COVER - ACCESSORIES

PTFE safety cover are designed to increase protection and reduce heat loss when working with round bottom flasks and VELP hemispheric bowls.

PTFE Safety Cover Hemispheric Bowl 50 ml	A00000342*	PTFE Safety Cover Hemispheric Bowl 500 ml	A00000345*
PTFE Safety Cover Hemispheric Bowl 100 ml	A00000343*	PTFE Safety Cover Hemispheric Bowl 100 ml	A00000346*
PTFE Safety Cover Hemispheric Bowl 250 ml	A00000344*		

* not available in USA, Mexico and Canada

HEMISPHERIC BOWLS™ - ACCESSORIES

The Hemispheric Bowls are the most suitable solution to replace oil baths and mantles in order to perform clean and safe analysis with round bottom flasks. VELP Hemispheric Bowl precisely fit the 135 mm diameter plate and the flask surface, ensuring the fastest heat transfer

	VOLUME		VOLUME		
	A00000373	25 ml		A00000333	500 ml
	A00000330	50 ml		A00000334	1 L
	A00000331	100 ml		A00000374	3 L
	A00000332	250 ml		A00000375	5 L



ALUBLOCK™ - ACCESSORIES

The new MonoAluBlock™ and MultiAluBlock™ permits to perform numerous reactions, reducing time and bench space also achieving the highest stirring and heating performances.

MonoAluBlock™ are the ideal solution for all the application that require to stir multiple vials of the same dimensions. MultiAluBlock™ consist of small combinable segments in order to accommodate different sizes of vials at the same time. The user can select the most suitable mix for his application

■ MonoAluBlock™		NUMBER OF PLACES	VOLUME (ml)	VIAL DIAMETER (mm)	HOLE DEPTH (mm)
	A00000340	17	40	28	43
	A00000339	17	30	28	30
	A00000338	17	20	28	24
	A00000341	40	2	12	14
■ MultiAluBlock™		NUMBER OF PLACES	VOLUME (ml)	VIAL DIAMETER (mm)	HOLE DEPTH (mm)
	A00000324	4	40	28	43
	A00000325	4	30	28	30
	A00000326	4	20	28	24
	A00000327	4	16	21	31
	A00000328	8	8	17	26
	A00000329	11	4	15	20
	A00000337	11	2	12	14
	A00000323	1	-	-	-

■ AREC Connect

Innovative, safe and accurate Ceramic Hot Plate Stirrer with embedded Wi-Fi technology to monitor and control laboratory reactions through VELP Ermes cloud platform. Precise thermoregulation and powerful stirring for microbiological, pharmaceutical, chemical and cosmetic laboratories requiring accuracy and efficiency.

OUTSTANDING PERFORMANCE

The brushless motors ensure longevity and guarantee powerful stirring. The cutting-edge heating plate technology ensures temperature homogeneity and stability up to 550 °C. The stirring volume of up to 20 L (H₂O) with excellent coupling.

PRECISE THERMOREGULATION

Excellent thermoregulation performance with Pt100 probe. Thermoregulation range from room temperature to 300 °C with 0.5 °C accuracy.

SAFE AND RESISTANT

The high-quality ceramic top and technopolymer structure ensure premium resistance to chemicals. Safe hot plate warnings when the plate temperature is above 50 °C. The Lock button to prevent unintentional changes

INTUITIVE AND EASY-TO-USE

Easy to operate digital interface with icons.



ermes enabled



Volume (H₂O)
20 L



Stirring speed
From 30 to 1700 rpm



Temperature range
From room temperature
to 550 °C



External connection
Pt 100 Probe

CONFIGURATIONS - AREC Connect

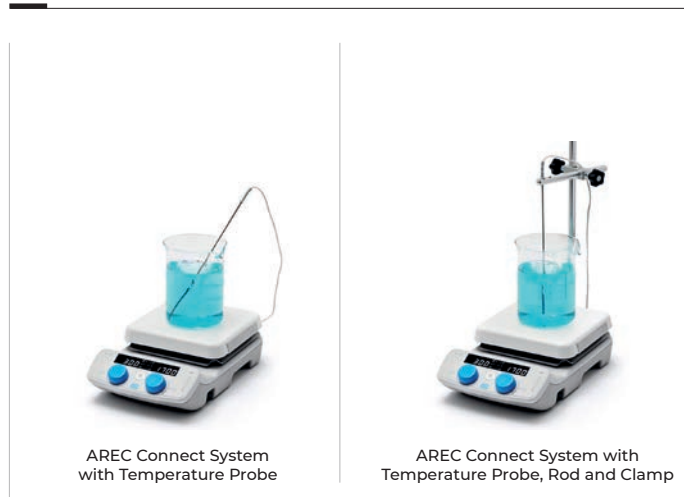

AREC Connect System
with Temperature Probe

AREC Connect System with
Temperature Probe, Rod and Clamp

INSTRUMENT - CODE

AREC Connect with Temperature Probe	230 V / 50-60 Hz	SA20500550
AREC Connect with Temperature Probe	115 V / 60 Hz	SA20510550
AREC Connect with Temperature Probe, Rod and Clamp	230 V / 50-60 Hz	SB20500550
AREC Connect with Temperature Probe, Rod and Clamp	115 V / 60 Hz	SB20510550

Included: Magnetic stir bar Ø 8x40 mm.



■ AREC.X

The AREC.X is designed for accurate thermoregulation offering state-of-the-art stirring and heating performance, superior safety features and ease-of-use. The ideal solution for laboratories requiring precise control of the medium's temperature.

EXCELLENT PERFORMANCE

The cutting-edge heating plate technology that ensures temperature homogeneity and stability from room temperature up to 550 °C. Stirring volume of up to 15 L (H₂O).

PRECISE THERMOREGULATION

Optimum thermoregulation of the medium with Pt100 probe (± 1 °C) and VTF Digital Thermoregulator (± 0.5 °C). Thermoregulation range from room temperature to 250 °C.

SAFE AND RESISTANT

The high-quality ceramic top and technopolymer structure ensure premium resistance to chemicals. Safe hot plate warnings when the plate temperature is above 50 °C. The Run-off groove is designed to protect the electronics.



Volume (H₂O)
15 L



Stirring speed
Up to 1500 rpm



Temperature range
From room temperature
to 550 °C



External connection
Pt 100 Probe



External connection
VTF

CONFIGURATIONS - AREC.X

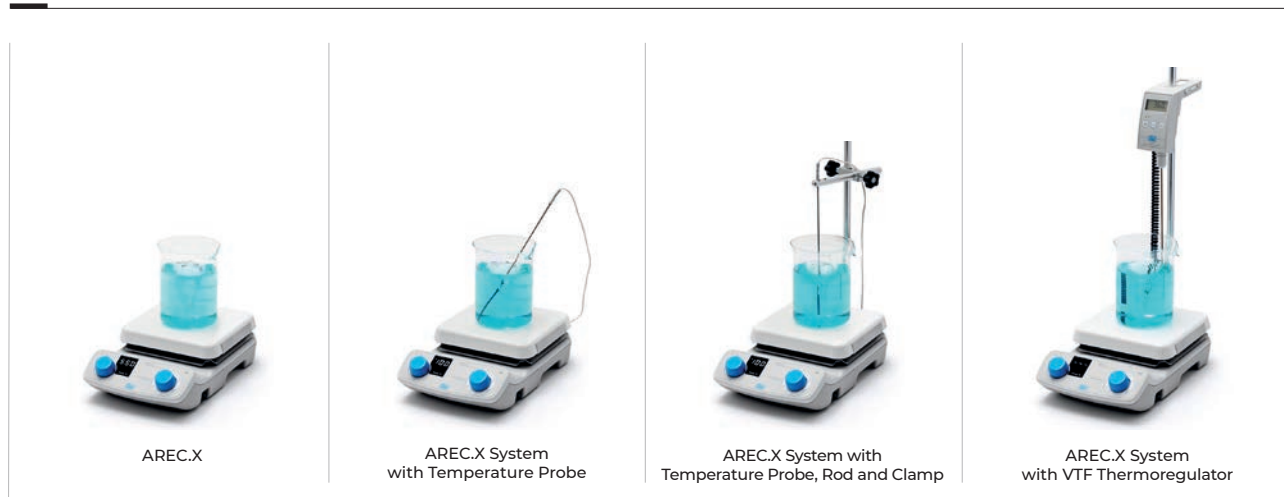

AREC.X

AREC.X System
with Temperature Probe

AREC.X System with
Temperature Probe, Rod and Clamp

AREC.X System
with VTF Thermoregulator

INSTRUMENT - CODE

AREC.X	230 V / 50-60 Hz	F20500554
AREC.X	115 V / 60 Hz	F20510554
AREC.X with Temperature Probe	230 V / 50-60 Hz	SA20500554
AREC.X with Temperature Probe	115 V / 60 Hz	SA20510554
AREC.X with Temperature Probe, Rod and Clamp	230 V / 50-60 Hz	SB20500554
AREC.X with Temperature Probe, Rod and Clamp	115 V / 60 Hz	SB20510554
AREC.X with VTF	230 V / 50-60 Hz	SC20500554
AREC.X with VTF	115 V / 60 Hz	SC20510554

Included: Magnetic stir bar Ø 8x40 mm.



■ AREC

The AREC is the safe and reliable hot plate stirrer with ceramic top guaranteeing excellent heat transfer and stirring performance for basic laboratory applications not requiring thermoregulation of the medium.

EXCELLENT PERFORMANCE

The cutting-edge heating plate technology that ensures temperature homogeneity and stability from room temperature up to 550 °C. Stirring volume of up to 15 L (H₂O).

SAFE AND RESISTANT

The high-quality ceramic top and technopolymer structure ensure premium resistance to chemicals. Safe hot plate warnings when the plate temperature is above 50°C. The Run-off groove is designed to protect the electronics.



Volume (H₂O)
15 L



Stirring speed
Up to 1500 rpm



Temperature range
From room temperature
to 550 °C

INSTRUMENT - CODE

AREC	230 V / 50-60 Hz	F20500551
AREC	115 V / 60 Hz	F20510551

Included: Magnetic stir bar Ø 8x40 mm.



■ HSC

The HSC is the safe and powerful analog hot plate stirrer for applications that do not require accurate temperature control of the medium. The ideal solution for academia's chemistry and biology laboratories.

ENTRY LEVEL SOLUTION

The cutting-edge heating plate technology that ensures temperature homogeneity and stability from room temperature up to 400 °C. Stirring volume of up to 15 L (H₂O).

SAFE AND RESISTANT

The high-quality ceramic top and technopolymer structure ensure premium resistance to chemicals. The Run-off groove is designed to protect the electronics.



Volume (H₂O)
15 L



Stirring speed
Up to 1300 rpm



Temperature range
From room temperature
to 400 °C

INSTRUMENT - CODE

HSC	230 V / 50-60 Hz	F20500552
HSC	115 V / 60 Hz	F20510552



ACCESSORIES - AREC & HSC

	AREC Connect	AREC.X	AREC	HSC
A00000273 Hemispheric bowl for 50 ml flasks	•	•	•	•
A00000258 Hemispheric bowl for 100 ml flasks	•	•	•	•
A00001071 Hemispheric bowl for 250 ml flasks	•	•	•	•
A00001072 Hemispheric bowl for 500 ml flasks	•	•	•	•
A00001073 Hemispheric bowl for 1000 ml flasks	•	•	•	•
A00001056 Magnetic stir bar, Ø 6x35 mm	•	•	•	•
A00000356 Magnetic stir bar, Ø 8x40 mm	•	•	•	•
A00000387 Magnetic stir bar, Ø 8x50 mm	•	•	•	•
A00001061 Magnetic stir bar, Ø 10x60 mm	•	•	•	•
A00000355 Magnetic disc stir bar Ø 20x10mm	•	•	•	•
A00001069 Support rod	•	•	•	•
A00000382 Extension for support rod	•	•	•	•
A00000280 Clamp for PT100 probe	•	•		
A00000268 Temperature Probe AISI 316 Ti Ø 3 mm	•	•		
A00000349 Temperature Probe glass coated Ø 5 mm	•	•		
F208B0063 VTF Digital Thermoregulator		•		
A00000421 IQ/OQ AREC Connect Manual	•			
E00010012 VELP Ermes 1 Year Connection	•			
E00010036 VELP Ermes 3 Years Connection	•			



■ MULTI-HS 15 Digital

Digital multi-position magnetic stirrer with heating designed to guarantee excellent stirring and heating performance for application with 15 positions working under identical conditions. The MULTI-HS presents exclusive features such as timer, autoreverse, safety lock, SpeedServo™ technology and CerAlTop™ plate.

EXCELLENT PERFORMANCE

The brushless motors ensure longevity and guarantee constant speed in all positions.

SAFE AND PROGRAMMABLE

Safe hot plate warnings when the plate temperature is above 50 °C. Lock feature to prevent unintentional modifications. Unattended stirring from 1 minute to 99 h : 59 minutes.

EASY TO USE

Easy to operate digital interface with icons. An acoustic signal/sound informs you when the countdown is over.



Volume (H₂O)
250 ml (x15)



Stirring speed
From 100 to 1000 rpm



Temperature range
From room temperature
to 120 °C



Timer &
Auto-reverse



Safety Lock

INSTRUMENT - CODE

MULTI-HS 15 Digital	230 V / 50-60 Hz	F20500531
MULTI-HS 15 Digital	115 V / 60 Hz	F20510531



MULTI-HS 6 Digital

Digital multi-position magnetic stirrer with heating designed to guarantee excellent stirring and heating performance for application with 6 positions working under identical conditions. The MULTI-HS presents exclusive features such as timer, autoreverse, safety lock, SpeedServo™ technology and CerAlTop™ plate.

EXCELLENT PERFORMANCE

The brushless motors ensure longevity and guarantee constant speed in all positions.

SAFE AND PROGRAMMABLE

Safe hot plate warnings when the plate temperature is above 50 °C.
Lock feature to prevent unintentional modifications.
Unattended stirring from 1 minute to 99 h : 59 minutes.

EASY TO USE

Easy to operate digital interface with icons. An acoustic signal/sound informs you when the countdown is over.



Volume (H₂O)
400 ml (x6)



Stirring speed
From 100 to 1000 rpm



Temperature range
From room temperature
to 120 °C



Timer &
Auto-reverse



Safety Lock

INSTRUMENT - CODE

MULTI-HS 6 Digital	230 V / 50-60 Hz	F20500530
MULTI-HS 6 Digital	115 V / 60 Hz	F20510530



ACCESSORIES - MULTI-HS Series

	MULTI_HS 6 Digital	MULTI_HS 15 Digital
A00001056 Magnetic stir bar Ø6x35 mm	•	•
A00001057 Magnetic stir bar Ø6x20 mm	•	•



VTF

The VTF thermoregulator guarantees premium performance in terms of temperature control with an accuracy of ± 0.5 °C. It automatically adjusts the thermoregulation to different factors such as power, load and thermal dispersion.

EASY TO USE

The VTF is equipped with a unique and innovative integrated system to simplify installation on the support rod.



Temperature range
From -10 °C to 300 °C



Timer
From 0 minute
to 24:59 hours

INSTRUMENT - CODE

VTF	12 V dc	F208B0063
		 

ACCESSORIES - VTF

	VTF
A00000002 Probe extension cable, 1 m	•
A00000003 Glass probe	•
A00000280 Clamp for Pt100 Probe	•
A00001069 Support rod	•

Heating Plates

■ RC

Single-position heating plate with aluminum top and temperature regulation. It is designed for the longest lifespan and guarantees excellent resistance to chemicals. It accepts different combinations of AluBlocks™ that can maximize temperature control and save handling time.

SAFETY AND RESISTANCE

Control panel is protected from liquid spills with run-off groove. IP 42 Certified.

EASY TO USE AND UNIVERSAL

Inclined control panel for easy access and visibility. Choice of mains voltage/frequency model.



Volume (H₂O)
15 L



Temperature range
From room temperature
to 370 °C



INSTRUMENT - CODE

RC	230 V / 50-60 Hz	F20700431
RC	115 V / 60 Hz	F20710431

■ RC2

Two-position heating plate with aluminum top and temperature regulation. It is designed for the longest lifespan and guarantees excellent resistance to chemicals. It accepts different combinations of AluBlocks™ that can maximize temperature control and save handling time.

SAFETY AND RESISTANCE

Control panel shielded against spillage.



Volume (H₂O)
15 L (x2)



Temperature range
From room temperature
to 370 °C



INSTRUMENT - CODE

RC2	230 V / 50-60 Hz	F20700430
RC2	115 V / 60 Hz	F20710430

■ REC

The VELP REC is the laboratory digital heating plate with ceramic top ensuring high resistance to corrosion, and precise temperature setting.

SAFETY AND RESISTANCE

The high-quality ceramic top and technopolymer structure ensure premium resistance to chemicals. The Ceramic heating plate guarantees optimum heat transfer on the entire surface and resistance to chemicals.

EASY TO USE

The bright digital display guarantees a precise temperature setting and showing actual and setpoint temperature. The Hot Surface Safety message displayed when the temperature is above 50 °C.



Volume (H₂O)
15 L



Temperature range
From room temperature
to 550 °C

INSTRUMENT - CODE

REC	230 V / 50-60 Hz	F20700553
REC	115 V / 60 Hz	F20710553



ACCESSORIES - HEATING PLATES

	RC	RC2	REC
A00000373 Hemispheric bowl for 25 ml flasks	•	•	
A00000330 Hemispheric bowl for 50 ml flasks	•	•	
A00000273 Hemispheric bowl for 50 ml flasks			•
A00000331 Hemispheric bowl for 100 ml flasks	•	•	
A00000258 Hemispheric bowl for 100 ml flasks			•
A00000332 Hemispheric bowl for 250 ml flasks	•	•	
A00001071 Hemispheric bowl for 250 ml flasks			•
A00000333 Hemispheric bowl for 500 ml flasks	•	•	
A00001072 Hemispheric bowl for 500 ml flasks			•
A00001073 Hemispheric bowl for 1000 ml flasks			•
A00000334 Hemispheric bowl for 1000 ml flasks	•	•	
A00000374 Hemispheric bowl for 3 L flasks	•	•	
A00000375 Hemispheric bowl for 5 L flasks	•	•	
A00000323 MultiAluBlock™ Base Ø135 mm	•	•	
A00000324 MultiAluBlock™, 4 pos. Ø 28 x h 43 mm	•	•	
A00000325 MultiAluBlock™, 4 pos. Ø 28 x h 30 mm	•	•	
A00000326 MultiAluBlock™, 4 pos. Ø 28 x h 24 mm	•	•	
A00000327 MultiAluBlock™, 4 pos. Ø 21 x h 31 mm	•	•	
A00000328 MultiAluBlock™, 8 pos. Ø 17 x h 26 mm	•	•	
A00000329 MultiAluBlock™, 11 pos. Ø 15 x h 20 mm	•	•	
A00000337 MultiAluBlock™, 11 pos. Ø 12 x h 14 mm	•	•	
A00000340 MonoAluBlock, 17 pos. Ø 28 x h 43 mm	•	•	
A00000339 MonoAluBlock, 17 pos. Ø 28 x h 30 mm	•	•	
A00000338 MonoAluBlock, 17 pos. Ø 28 x h 24 mm	•	•	
A00000341 MonoAluBlock, 40 pos. Ø 12 x h 14 mm	•	•	
A00000342 PTFE Safety cover for bowl 50 ml	•	•	
A00000343 PTFE Safety cover for bowl 100 ml	•	•	
A00000344 PTFE Safety cover for bowl 250 ml	•	•	
A00000345 PTFE Safety cover for bowl 500 ml	•	•	
A00000346 PTFE Safety cover for bowl 1000 ml	•	•	
A00001069 Support rod	•	•	•
A00000382 Extension for support rod			•
A00000351 Handle for AluBlock removal	•	•	

Overhead Stirrers

■ OHS 200 Advance

Powerful Wi-Fi Enabled Laboratory overhead stirrer with a TFT 3.5" Display that shows all setting information at a glance. Wi-Fi Connection to VELP Ermes Platform allows remote monitoring and control of operations in real-time. USB interface for use with optional PC software to data log, monitor, turn off/on. Pt100 probe included allowing real-time temperature monitoring.

CONSTANT TORQUE AT ANY SPEED







The powerful brushless motor and electronic control guarantee 200 Ncm torque (speed gear 1) at any speed. Double speed gear for an excellent performance for high volumes and high viscosities.

EASY TO USE

Smartchuck™ system simplifies the shaft accommodation without tools and with one hand only.

SAFE AND RESISTANT

The resistant sealed housing guarantees durability in the most aggressive environments. IP 54 certified.

					
Volume (H ₂ O) 100 L	Viscosity Up to 100.000 mPa*s	Torque GEAR 1: 200 Ncm	Stirring speed GEAR 1: 6-400 rpm GEAR 2: 30-2000 rpm	Timer and programmable methods	Safety Lock



ermes enabled

INSTRUMENT - CODE

OHS 200 Advance	230 V / 50-60 Hz	F20100480
OHS 200 Advance	115 V / 60 Hz	F20110480



■ OHS 100 Advance

Powerful Wi-Fi Enabled Laboratory overhead stirrer with a TFT 3.5" Display that shows all setting information at a glance. Wi-Fi Connection to VELP Ermes Platform allows remote monitoring and control of operations in real-time. USB interface for use with optional PC software to data log, monitor, turn off/on. Pt100 probe included allowing real-time temperature monitoring.

CONSTANT TORQUE AT ANY SPEED







The powerful brushless motor and electronic control guarantee 100 Ncm torque at any speed.

EASY TO USE

Smartchuck™ system simplifies the shaft accommodation without tools and with one hand only.

SAFE AND RESISTANT

The resistant sealed housing guarantees durability in the most aggressive environments. IP 54 certified.

					
Volume (H ₂ O) 100 L	Viscosity Up to 70.000 mPa*s	Torque 100 Ncm	Stirring speed From 30 to 1300 rpm	Timer and programmable methods	Safety Lock



ermes enabled

INSTRUMENT - CODE

OHS 100 Advance	230 V / 50-60 Hz	F20100481
OHS 100 Advance	115 V / 60 Hz	F20110481



■ OHS 60 Advance

Powerful Wi-Fi Enabled Laboratory overhead stirrer with a TFT 3.5" Display that shows all setting information at a glance. Wi-Fi Connection to VELP Ermes Platform allows remote monitoring and control of operations in real-time. USB interface for use with optional PC software to data log, monitor, turn off/on. Pt100 probe included allowing real-time temperature monitoring.

CONSTANT TORQUE AT ANY SPEED

The powerful brushless motor and electronic control guarantee 60 Ncm torque at any speed.

EASY TO USE

Smartchuck™ system simplifies the shaft accommodation without tools and with one hand only.

SAFE AND RESISTANT

The resistant sealed housing guarantees durability in the most aggressive environments. IP 54 certified.





ermes enabled

- 

Volume (H₂O)
40 L
- 

Viscosity
Up to 50.000 mPa*s
- 

Torque
60 Ncm
- 

Stirring speed
From 30 to 2000 rpm
- 

Timer and programmable methods
- 

Safety Lock

INSTRUMENT - CODE

OHS 60 Advance	230 V / 50-60 Hz	F20100482
OHS 60 Advance	115 V / 60 Hz	F20110482



■ OHS 200 Digital

Powerful overhead stirrer with digital display to precisely set stirring speed and timer. Dedicated 4 segment LED display showing the torque trend. Intuitive knob to navigate the menu and start stop operations.

CONSTANT TORQUE AT ANY SPEED

The powerful brushless motor and electronic control guarantee 200 Ncm torque (speed gear 1) at any speed. Double speed gear for an excellent performance for high volumes and high viscosities.

EASY TO USE

Smartchuck™ system simplifies the shaft accommodation without tools and with one hand only.

SAFE AND RESISTANT

The resistant sealed housing guarantees durability in the most aggressive environments. IP 54 certified.



- 

Volume (H₂O)
100 L
- 

Viscosity
Up to 100.000 mPa*s
- 

Torque
GEAR 1: 200 Ncm
- 

Stirring speed
GEAR 1: 6-400 rpm
GEAR 2: 30-2000 rpm
- 

Timer
- 

Safety Lock

INSTRUMENT - CODE

OHS 200 Digital	230 V / 50-60 Hz	F20100490
OHS 200 Digital	115 V / 60 Hz	F20110490



■ OHS 100 Digital

Powerful overhead stirrer with digital display to precisely set stirring speed and timer. Dedicated 4 segment LED display showing the torque trend. Intuitive knob to navigate the menu and start stop operations.

CONSTANT TORQUE AT ANY SPEED

The powerful brushless motor and electronic control guarantee 100 Ncm torque at any speed.







EASY TO USE

Smartchuck™ system simplifies the shaft accommodation without tools and with one hand only.

SAFE AND RESISTANT

The resistant sealed housing guarantees durability in the most aggressive environments. IP 54 certified.



					
Volume (H ₂ O) 100 L	Viscosity Up to 70.000 mPa*s	Torque 100 Ncm	Stirring speed From 30 to 1300 rpm	Timer	Safety Lock

INSTRUMENT - CODE

OHS 100 Digital	230 V / 50-60 Hz	F20100491
OHS 100 Digital	115 V / 60 Hz	F20110491



■ OHS 60 Digital

Powerful overhead stirrer with digital display to precisely set stirring speed and timer. Dedicated 4 segment LED display showing the torque trend. Intuitive knob to navigate the menu and start stop operations.

CONSTANT TORQUE AT ANY SPEED

The powerful brushless motor and electronic control guarantee 60 Ncm torque at any speed.







EASY TO USE

Smartchuck™ system simplifies the shaft accommodation without tools and with one hand only.

SAFE AND RESISTANT

The resistant sealed housing guarantees durability in the most aggressive environments. IP 54 certified.



					
Volume (H ₂ O) 40 L	Viscosity Up to 50.000 mPa*s	Torque 60 Ncm	Stirring speed From 30 to 2000 rpm	Timer	Safety Lock

INSTRUMENT - CODE

OHS 60 Digital	230 V / 50-60 Hz	F20100492
OHS 60 Digital	115 V / 60 Hz	F20110492



■ OHS 40 Digital

Powerful overhead stirrer with digital display to precisely set stirring speed and timer. Dedicated 4 segment LED display showing the torque trend. Intuitive knob to navigate the menu and start stop operations.

CONSTANT TORQUE AT ANY SPEED

The powerful brushless motor and electronic control guarantee 40 Ncm torque at any speed.

EASY TO USE

Smartchuck™ system simplifies the shaft accommodation without tools and with one hand only.

SAFE AND RESISTANT

The resistant sealed housing guarantees durability in the most aggressive environments. IP 54 certified.



Volume (H₂O)
25 L



Viscosity
Up to 25.000 mPa*s



Torque
40 Ncm



Stirring speed
From 30 to 2000 rpm



Timer



Safety Lock

INSTRUMENT - CODE

OHS 40 Digital	230 V / 50-60 Hz	F20100493
OHS 40 Digital	115 V / 60 Hz	F20110493



■ OHS 20 Digital

Powerful overhead stirrer with digital display to precisely set stirring speed and timer. Dedicated 4 segment LED display showing the torque trend. Intuitive knob to navigate the menu and start stop operations.

CONSTANT TORQUE AT ANY SPEED

The powerful brushless motor and electronic control guarantee 20 Ncm torque at any speed.

EASY TO USE

Smartchuck™ system simplifies the shaft accommodation without tools and with one hand only.

SAFE AND RESISTANT

The resistant sealed housing guarantees durability in the most aggressive environments. IP 54 certified.



Volume (H₂O)
25 L



Viscosity
Up to 10.000 mPa*s



Torque
20 Ncm



Stirring speed
From 30 to 2000 rpm



Timer



Safety Lock

INSTRUMENT - CODE

OHS 20 Digital	230 V / 50-60 Hz	F20100494
OHS 20 Digital	115 V / 60 Hz	F20110494



DLH

Digital overhead stirrer suitable for all medium to high-viscosity mixing tasks. The bright display provides easy-to-read details of four important parameters: set speed, actual speed, torque and time.

SAFETY AND EASY TO USE

The DLH is an intuitive overhead stirrer ensuring safety with overload, over-current and overheating protection.

COMPACT AND LIGHTWEIGHT

The special technopolymer structure and the IP 40 Protection Rating guarantee chemical resistance and easy handling, being among the lightest overhead stirrer on the market.



				
Volume (H ₂ O) 40 L	Viscosity Up to 50.000 mPa*s	Torque 80 Ncm	Stirring speed From 50 to 2000 rpm	Timer

INSTRUMENT - CODE

DLH	110-230 V / 50-60 Hz	F201A0157
		 

DLS

Digital overhead stirrer suitable for all medium viscosity mixing tasks. The bright display provides easy-to-read details of four important parameters: set speed, actual speed, torque and time.

SAFETY AND EASY TO USE

The DLS is an intuitive overhead stirrer ensuring safety with overload, over-current and overheating protection.

COMPACT AND LIGHTWEIGHT

The special technopolymer structure and the IP 40 Protection Rating guarantee chemical resistance and easy handling, being among the lightest overhead stirrer on the market.



				
Volume (H ₂ O) 25 L	Viscosity Up to 25.000 mPa*s	Torque 40 Ncm	Stirring speed From 50 to 2000 rpm	Timer

INSTRUMENT - CODE

DLS	110-230 V / 50-60 Hz	F201A0155
DLS - System	110-230 V / 50-60 Hz	SA201A0155*

* Universal H-Stand, Double Clamp, Stirring Shaft with Propeller included.



■ PW

Laboratory overhead stirrer with analog control suitable for high viscosity mixing applications. Easy to install and to operate thanks to the hand-tightened chuck requiring no tools.

SAFETY AND EASY TO USE

The PW ensures safety with overload, over-current and overheating protection.

COMPACT AND LIGHTWEIGHT

The special technopolymer structure and the IP 40 Protection Rating guarantee chemical resistance and easy handling, being among the lightest overhead stirrer on the market.



Volume (H₂O)
70 L



Viscosity
Up to 100.000 mPa*s



Torque
120 Ncm



Stirring speed
From 20 to 1200 rpm

INSTRUMENT - CODE

PW

110-230 V / 50-60 Hz

F201A0150



■ LH

Laboratory overhead stirrer with analog control suitable for high viscosity mixing applications. Easy to install and to operate thanks to the hand-tightened chuck requiring no tools.

SAFETY AND EASY TO USE

The LH ensures safety with overload, over-current and overheating protection.

COMPACT AND LIGHTWEIGHT

The special technopolymer structure and the IP 40 Protection Rating guarantee chemical resistance and easy handling, being among the lightest overhead stirrer on the market.



Volume (H₂O)
40 L



Viscosity
Up to 50.000 mPa*s



Torque
80 Ncm



Stirring speed
From 50 to 2000 rpm

INSTRUMENT - CODE

LH

110-230 V / 50-60 Hz

F201A0156



■ LS

Laboratory overhead stirrer with analog control suitable for high viscosity mixing applications. Easy to install and to operate thanks to the hand-tightened chuck requiring no tools.

SAFETY AND EASY TO USE

The LS ensures safety with overload, over-current and overheating protection.

COMPACT AND LIGHTWEIGHT

The special technopolymer structure and the IP 40 Protection Rating guarantee chemical resistance and easy handling, being among the lightest overhead stirrer on the market.



Volume (H₂O)
25 L



Viscosity
Up to 25.000 mPa*s



Torque
40 Ncm



Stirring speed
From 50 to 2000 rpm



INSTRUMENT - CODE

LS	110-230 V / 50-60 Hz	F201A0151
LS - System	110-230 V / 50-60 Hz	SA201A0151*

* Universal H-Stand, Double Clamp, Stirring Shaft with Fixed Blade included.



■ ES

Laboratory overhead stirrer with analog control suitable for low viscosity mixing applications. Easy to install and to operate thanks to the hand-tightened chuck requiring no tools.

SAFETY AND EASY TO USE

The ES ensures safety with overload, over-current and overheating protection.

COMPACT AND LIGHTWEIGHT

The special technopolymer structure and the IP 40 Protection Rating guarantee chemical resistance and easy handling, being among the lightest overhead stirrer on the market.



Volume (H₂O)
15 L



Viscosity
Up to 1.000 mPa*s



Torque
15 Ncm



Stirring speed
From 50 to 1300 rpm



INSTRUMENT - CODE

ES	110-230 V / 50-60 Hz	F201A0152
----	----------------------	-----------



ACCESSORIES - OVERHEAD STIRRERS

	OHS Advance	OHS Digital	DLH	DLS	PW	LH	LS	ES
A00001301 Double clamp	•	•	•	•	•	•	•	•
A00001302 Ribbon clamp	•	•	•	•	•	•	•	•
A00001312 Chuck guard OHS	•	•						
A00000372 Support rod for probe	•							
A00000002 Probe extension cable, length 1 m	•							
A00000003 Glass probe for VTF	•							
TA00000394 Kit Pt100 probe XL for OHS	•							
A00000381 IQ/OQ Manual OHS Digital		•						
A00000380 IQ/OQ Manual OHS Advance	•							
A00000391 OHS/ControllerSoft	•							
E00010012 VELP Ermes 1 Year Connection	•							
E00010036 VELP Ermes 3 Year Connection	•							

STIRRING SHAFTS - ACCESSORIES

VELP H-Stands are the ideal solution when the overhead stirrer is working on laboratory benches.

We have designed our H-Stand to guarantee the maximum stability thanks to the H-shape of the base and the maximum resistance choosing premium materials such as aluminum and stainless steel, properly treated in order to resist to chemicals and corrosion.

The Telescopic H-Stand facilitates the daily operations being easy-to-use when raising and lowering the overhead stirrer from your sample.

UNIVERSAL H-STAND



Code A00000366

TELESCOPIC H-STAND



Code A00000369

STIRRING SHAFTS - ACCESSORIES

Overhead stirrers require stirring shaft for precise working. Choosing the correct stirring shaft is an important step to obtain the best stirring performance.

It is important to evaluate the characteristics and the effects on the fluid of the stirring shaft, together with the volume and viscosity:

- Desired type of flow: Axial, Tangential, Radial;
- Speed range of your application.

STIRRING SHAFT WITH FLOATING BLADES
(VL - L)

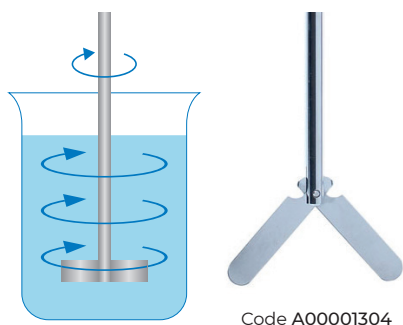

STIRRING SHAFT WITH 6-HOLE PADDLE
(L - M)

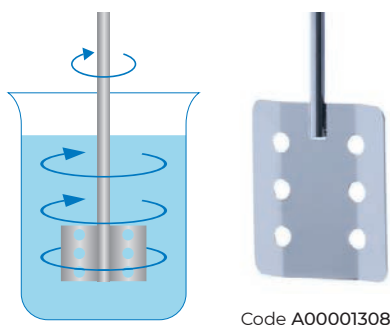

STIRRING SHAFT WITH FIXED BLADE
(VL - L - M)

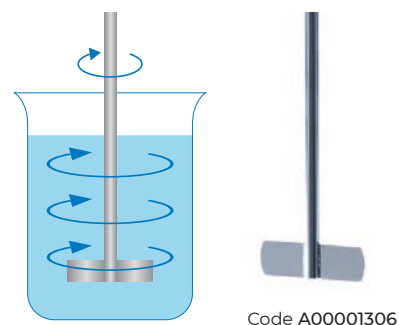

STIRRING SHAFT WITH TURBO PROPELLER
(M - H)

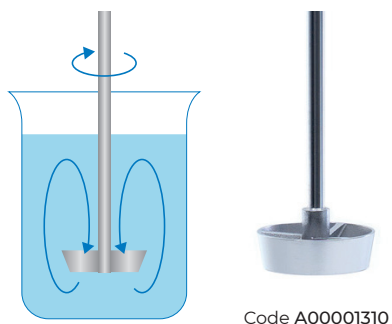

STIRRING SHAFT WITH FOLDING BLADE
(VL - L)

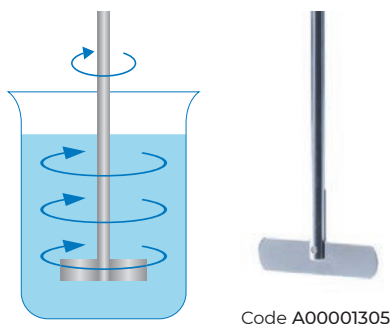

STIRRING SHAFT WITH TURBINE
(M - H)

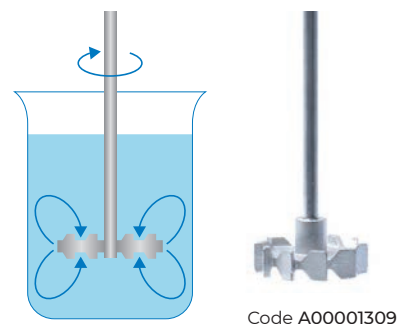

STIRRING SHAFT WITH PROPELLER
(VL - L - M)

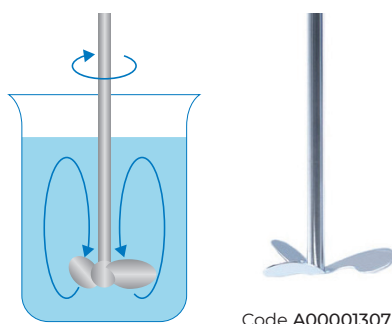

STIRRING SHAFT WITH ANCHOR
(M - H)

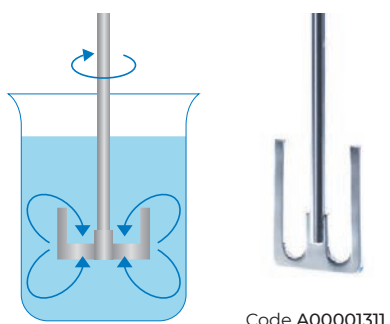

VISCOSITY RANGE

Viscosity Range	
Very Low (VL)	0 - 100
Low (L)	100 - 1,000
Medium (M)	1,000 - 10,000
High (H)	10,000 - 100,000

SAMPLE VISCOSITY

Sample	mPa*s
Water	1
Kerosene	10
Lubricating oil	100
Castrol oil, Glycerin	1,000
Shampoo	3,000
Refined honey	7,000
Body cream	8,000
Honey	10,000
Chocolate syrup	25,000
Ketchup	50,000
Toothpaste	70,000
Molasses, Asphalt	100,000

■ CONTROLLER Advance (not available in USA, Mexico and Canada)

Powerful and innovative solution designed to control brushless motors of Reaction Systems of up to 100 L volume. The Controller Advance features a TFT 3.5" Display that shows all setting information at a glance. Wi-Fi Connection to Velp Ermes Platform to monitor status and data logging on the cloud. USB interface for use with optional PC software to data log, monitor, turn off/on. USB also allow Software Updates.

- Timer for unattended operations
- Real time torque, speed and temperature graph monitoring
- Intuitive knob to navigate the menu and start stop operations
- Programmable methods to setup to 4 Time/Speed Ramps.



Timer



Safety Lock



CW/CCW
Direction Changes



ermes enabled

INSTRUMENT - CODE

Controller Advance

115-230 V / 50-60 Hz

F201A0500



■ CONTROLLER Digital (not available in USA, Mexico and Canada)

Powerful and innovative solution designed to control brushless motors of Reaction Systems of up to 100 L volume. The Controller Digital features a digital display to set the speed and a 4 segment LED display to monitor torque.

- Timer for unattended operations
- Intuitive knob to navigate the menu and start stop operations
- Clockwise and counterclockwise direction changes.



Timer



Safety Lock



CW/CCW
Direction Changes



INSTRUMENT - CODE

Controller Digital

115-230 V / 50-60 Hz

F201A0505



ACCESSORIES - CONTROLLER

	CONTROLLER ADVANCE	CONTROLLER DIGITAL
A00000391 OHS/ControllerSoft	•	
A00000394 Pt100 Probe XL Ø6 500mm	•	
A00000415 Motor 10 lb*in, 471 rpm , 1/11 HP - 24V	•	•
A00000416 Motor 28 lb*in, 500 rpm , 1/11 HP - 24V	•	•
A00000417 Motor 55 lb*in, 250 rpm , 1/11 HP - 24V	•	•
E00010012 VELP Ermes 1 year Connection	•	
E00010036 VELP Ermes 3 year Connection	•	

Vortex Mixers

■ Wizard IR

Vortex mixer featuring the highly innovative and patented IR technology to reduce repetitive strains. IR sensor and Continuous mode available. Large choice of complementary accessories to accommodate tubes, plates and flasks.

EXCLUSIVE ERGONOMICS

The VELP IR sensor uses an infrared system (IR) to detect the presence of the tube and automatically starts vibrating. No pressure is required to maintain vibration, drastically reducing arm stress.

STABLE AND ROBUST

Robust low profile design provides exceptional stability. The technopolymer housing and zinc base ensure optimum chemical resistance and excellent stability on the bench.



Stirring speed
Up to 3000 rpm



Patented
IR Sensor



INSTRUMENT - CODE

Wizard

100÷240 V / 50-60 Hz

F202A0175



■ Classic

Compact vortex mixer suitable for different mixing requirements, with touch or continuous mode. It is highly resistant to chemicals and has 3 anti-slip rubber feet for stability.

ROBUST AND CONVENIENT

The IP 42 Protection Rating and the technopolymer casing guarantee good chemical resistance against particles and liquids. It uses universal voltage/frequency.

VERSATILE

Large choice of accessories to suit tubes, plates and flasks. Accessories fit by simple pressure.



Stirring speed
Up to 3000 rpm



INSTRUMENT - CODE

Classic

100÷240 V / 50-60 Hz

F202A0173



TX4

Exclusive digital vortex mixer featuring the highly innovative and patented IR technology to reduce repetitive strains. The bright digital display ensures precision and reproducibility. The integrated timer allows programming the vortex for unattended operations. Large choice of complementary accessories to accommodate tubes, plates and flasks.

EXCLUSIVE ERGONOMICS

The VELP IR sensor uses an infrared system (IR) to detect the presence of the tube and automatically starts vibrating. No pressure is required to maintain vibration, drastically reducing arm stress.

STABLE AND ROBUST

The technopolymer housing and zinc base ensure optimum chemical resistance and excellent stability on the bench.



Stirring speed
Up to 3000 rpm



Patented
IR Sensor



Timer

INSTRUMENT - CODE

TX4

100÷240 V / 50-60 Hz

F202A0270



ZX4

ZX4 Vortex mixer is highly innovative and patented IR technology reduces repetitive strains. IR sensor and continuous mode available. Large choice of complementary accessories to accommodate tubes, plates and flasks.

EXCLUSIVE ERGONOMICS

The VELP IR sensor uses an infrared system (IR) to detect the presence of the tube and automatically starts vibrating. No pressure is required to maintain vibration, drastically reducing arm stress.

STABLE AND ROBUST

The technopolymer housing and zinc base ensure optimum chemical resistance and excellent stability on the bench.



Stirring speed
Up to 3000 rpm



Patented
IR Sensor

INSTRUMENT - CODE

ZX4

100÷240 V / 50-60 Hz

F202A0280

ZX4 and Foam Stands

80÷260 V / 50-60 Hz

SA202A0280*

* Stand for 19 microvials Eppendorf 1,5 ml, Customizable soft foam top and Small rubber supporting plate Ø 50mm included



ZX3

Reliable vortex mixer has adjustable stirring speed and touch or continuous mode. ZX3 features large, anti-slip rubber feet to ensure maximum stability. It is also highly resistant to chemicals.

ROBUST AND CONVENIENT

The IP 42 Protection Rating and the technopolymer casing guarantee good chemical resistance against particles and liquids. It uses universal voltage/frequency.

VERSATILE

Large choice of accessories to suit tubes, plates and flasks. Accessories fit by simple pressure.



Stirring speed
Up to 3000 rpm



INSTRUMENT - CODE

ZX3	100÷240 V / 50-60 Hz	F202A0176
ZX3 and Foam Stands	100÷240 V / 50-60 Hz	SA202A0176*

* Stand for 19 microvials Eppendorf 1,5 ml, Customizable soft foam top and Small rubber supporting plate Ø 50mm included



RX3

Basic vortex mixer with fixed stirring speed and touch mode. RX3 features large, anti-slip rubber feet to ensure maximum stability. It is also highly resistant to chemicals.

ROBUST AND CONVENIENT

The IP 42 Protection Rating and the technopolymer casing guarantee high-grade chemical resistance.



Stirring speed
3000 rpm



INSTRUMENT - CODE

RX3	100÷240 V / 50-60 Hz	F202A0171
-----	----------------------	-----------



ACCESSORIES - VORTEX MIXERS

	Wizard	Classic	TX4	ZX4	ZX3	RX3
A00000012 Foam stand for 19 microvials Eppendorf, 1.5 ml	•	•	•	•	•	
A00000013 Customizable soft foam top	•	•	•	•	•	
A00000014 Foam stand for 5 test tubes Ø 16 mm	•	•	•	•	•	
A00000015 Foam stand for microtiter	•	•	•	•	•	
A00000016 Small rubber supporting plate Ø 50 mm	•	•	•	•	•	•
A00000017 Rubber supporting plate Ø 94 mm		•			•	
A00000019 Foam stand for 4 tubes Ø 29 mm	•	•	•	•	•	
A00000389 Foam stand for 5 test-tubes Ø 24 mm	•	•	•	•	•	
10002021 Mixing cup head	•	•				
10005195 Mixing cup head			•	•	•	•
A000003083 Plug USA for power supply	•	•	•	•	•	•
10003084 Plug UK for power supply	•	•	•	•	•	•
10003085 Plug AU for power supply	•	•	•	•	•	•

ACCESSORIES - FOAM STAND

VELP vortex mixers can be connected to the dedicated platforms ensuring versatility for a variety of applications. VELP accessories are easy to fix on the vortex with a simple pressure and ensure excellent mixing performance of different types of tubes and containers.

CUSTOMIZABLE SOFT FOAM TOP

Code A00000013



FOAM STAND FOR 5 TEST-TUBES Ø 16 mm

Code A00000014



FOAM STAND FOR 5 TEST-TUBES Ø 24 mm

Code A00000389



FOAM STAND FOR 4 TEST-TUBES Ø 29 mm

Code A00000019



FOAM STAND FOR N° 19 MICROVIALS 1,5 ml

Code A00000012



FOAM STAND FOR MICROTITER

Code A00000015



MULTI-TX5

The MULTI-TX5 Digital is the exclusive solution for all the multi-tube mixing tasks, even the most challenging ones. The MULTI-TX5 Digital supports various foam racks for different vortexing tubes being an extremely versatile multi-tube vortex mixer to emulsify, disintegrate, mix, or homogenize samples.

SAFE AND PROGRAMMABLE

Lock feature to prevent unintentional modifications. Unattended stirring from 1 minute to 99 h : 59 minutes.

EASY TO USE

Easy to operate digital interface with icons. An acoustic signal/sound informs you when the countdown is over.

SIMPLIFIED OPERATION

With the MULTI-TX5 Digital you can perform any mixing tasks and then change the foam rack for your next application in just a few simple steps.



Stirring speed
From 100 to 2500 rpm



Timer &
Auto-reverse



Safety Lock

INSTRUMENT - CODE

MULTI-TX5 Digital Vortex

100÷240 V / 50-60 Hz

F202A0460



ACCESSORIES - SAMPLE RACK

Various foam racks for vortexing tubes with different dimensions ensure premium versatility in the lab and make the MULTI-TX5 Digital ideal for a wide variety of mixing applications.

SAMPLE RACK FOR TEST TUBE Ø 10 mm, 44 POSITIONS

Code A00000449



SAMPLE RACK FOR TEST TUBE Ø 12 mm, 44 POSITIONS

Code A00000450



SAMPLE RACK FOR TEST TUBE Ø 13 mm, 44 POSITIONS

Code A00000451



SAMPLE RACK FOR TEST TUBE Ø 16 mm, 44 POSITIONS

Code A00000452



SAMPLE RACK FOR TEST TUBE Ø 25 mm, 14 POSITIONS

Code A00000453



SAMPLE RACK FOR TEST TUBE Ø 29 mm, 14 POSITIONS

Code A00000454



Homogenizer

■ OV5

Versatile homogenizer ideal for dispersing, homogenizing and mixing biological tissues, pharmaceutical products, cosmetics and food products. Wide selection of rotors and stators to match the application.

ROBUST AND CONVENIENT

The stainless steel shafts, with PTFE seals, can be easily and quickly connected through a snap hook. OV5 has a smooth start and safety switch.

VERSATILE

OV5 has a wide selection of rotors and stators to match the application.



Volume (H₂O)
8 L



Stirring speed
Up to 3000 rpm



OPTIONAL - ACCESSORIES

Stator rotor release kit	A00000279
Double Rod Mini H-Stand Set	A00000383
Double clamp	A00001301
Strap clamp	A00000044

INSTRUMENT - CODE

OV5	230 V / 50 Hz	R20900010
OV5 - System	230 V / 50 Hz	SA20900010*

* Double Rod Mini H-Stand Set, VSS2CSR2 Dispersing tool included



CHOOSE THE MOST SUITABLE DISPERSING TOOL - COMPOSITION

HOMOGENIZER



SHAFT



STATOR



ROTOR



POSSIBLE COMBINATIONS - COMPOSITION

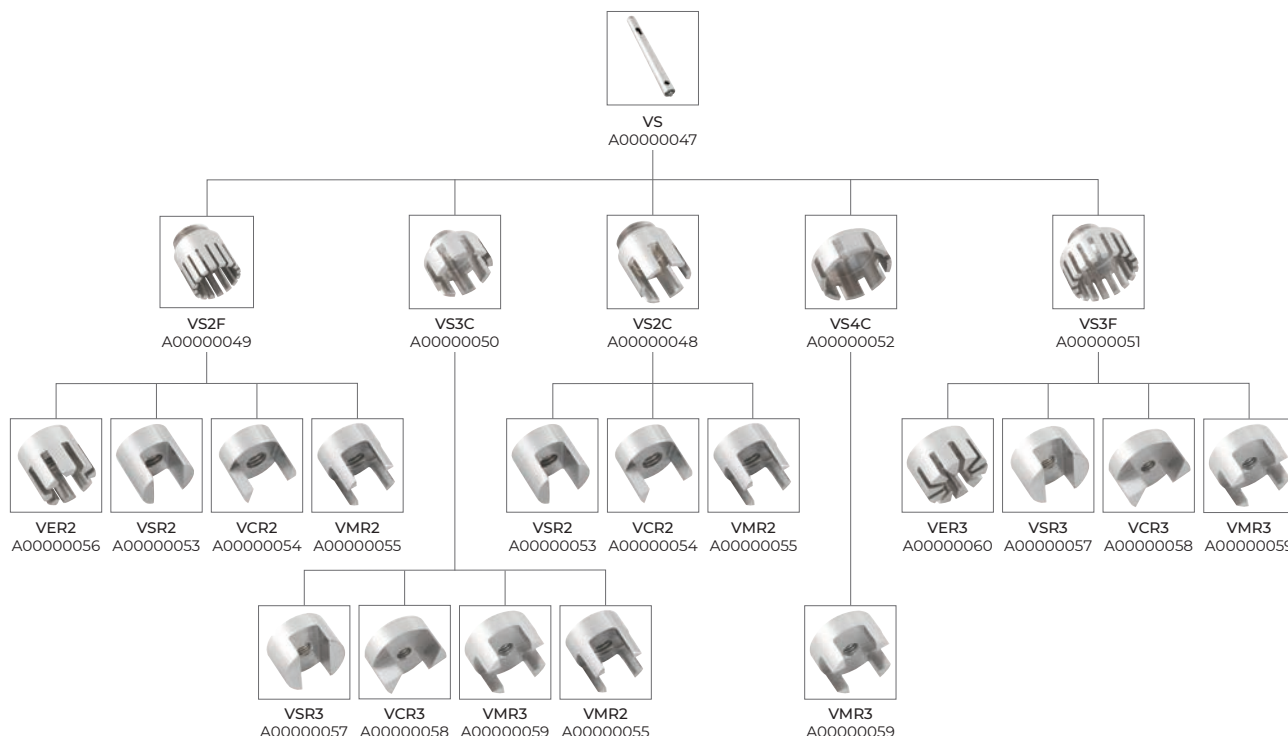

A STAND ALONE SOLUTION FOR A WIDE RANGE OF APPLICATIONS

OV5 Homogenizer is the right solution for dispersing, homogenizing and mixing biological tissue samples (cells, animal and vegetal tissues), pharmaceutical products, cosmetics and food products. The same model of shaft suitable for all the applications and configurable with different models of rotor and stator, for the specific application of the customer.

POSSIBLE COMBINATIONS - AVAILABLE CONFIGURATIONS

	Code No	Application field	Function	Treatable volume (water)	Max circum. speed	Ø Rotor	Ø Stator	Tool lenght	Min/max immersion depth	Ultimate fineness µm	Suspension emulsion
* VSS2CSR2	A00000026	CE, IF, PC, SI	A	100-5000	22,7	15 mm	20 mm	220 mm	40/175 mm	10-50	1-10
VSS2CCR2	A00000027	CT, IA, M, SI	B	100-5000	22,7	15 mm	20 mm	220 mm	40/175 mm	10-50	1-10
VSS2CMR2	A00000028	CE, VE	A	100-5000	22,7	15 mm	20 mm	220 mm	40/175 mm	10-50	1-10
*VSS2FER2	A00000029	CT, IF, SI, VE	C	100-5000	22,7	15 mm	20 mm	220 mm	40/175 mm	10-50	1-10
VSS2FCR2	A00000031	BT, CT, IA, IT, M, SI	B	100-5000	22,7	15 mm	20 mm	220 mm	40/175 mm	10-150	1-10
VSS2FMR2	A00000032	CE, CT, IA, IC, PC, VE	A	100-5000	22,7	15 mm	20 mm	220 mm	40/175 mm	10-150	1-10
*VSS3CSR3	A00000033	CT, IA, IF, M, SI	A	100-8000	34,9	23 mm	30 mm	220 mm	40/175 mm	5-25	1-5
VSS3CCR3	A00000034	CT, IA, IF, M, SI	B	100-8000	34,9	23 mm	30 mm	220 mm	40/175 mm	5-25	1-5
VSS3CMR3	A00000035	CE, VE	A	100-8000	34,9	23 mm	30 mm	220 mm	40/175 mm	5-25	1-5
VSS3CMR2	A00000036	CE, IA, SI	D	250-2000	34,9	15 mm	30 mm	220 mm	40/175 mm	High speed mixer	
*VSS3FER3	A00000037	CT, IF, SI, VE	C	100-8000	34,9	23 mm	30 mm	220 mm	40/175 mm	5-25	1-5
VSS3FSR3	A00000038	CT, IF, SI, VE	A	100-8000	34,9	23 mm	30 mm	220 mm	40/175 mm	5-25	1-5
VSS3FMR3	A00000040	CE, IA, IC, IF, IT	A	100-8000	34,9	23 mm	30 mm	220 mm	40/175 mm	5-25	1-5
*VSS4CMR3	A00000041	CE, IA, SI	D	1000-4000	34,9	23 mm	40 mm	220 mm	40/175 mm	High speed mixer	
**VSS5CSR4	A00000046	BT, M	A	0,2-50	6,3	4 mm	5 mm	128 mm	10/60 mm	10-50	1-10

* Most used model

** The dispersing tool works with Ø 4 mm rotor and Ø 5 mm stator for microbiological applications (e.g. suitable for Eppendorf, cuvettes, etc.)

*** BT = biotechnology, CE = ceramic industry, CT = paper & tissue industry, IA = food industry, IC = cosmetic industry, IF = pharmaceutical industry, IT = tobacco industry, M = medicine, PC = petrochemistry industry, SI = sewage pollution control, VE = paint industry

**** A = dispersing tool for solid/liquid media, B = dispersing tool with blades for fibrous/stringy materials, C = dispersing tool for water/oil or oil/water emulsions, D = stirring shaft

COD Thermoreactors

■ ECO 16

Thermoreactor with 16 positions (14 pos. with \varnothing 16 mm and 2 pos. \varnothing 22 mm) that provide easy and intuitive programming of both time and temperature. The unit automatically shuts down when the analysis time expires. The aluminum heating block offers optimum thermal conditions and a high level of homogeneity at all temperatures

INTUITIVE AND DIGITAL

ECO 16 ensures a simple and easy programming of time (from 1 to 199 minutes or continuous) and temperature (from ambient to 160 °C).

FAST AND SAFE

ECO 16 is suitable for performing a short time COD analysis, in only 30 minutes with a high thermoreaction temperature (160 °C). It has also the transparent test tube cover that offers a constant visual control.



Temperature range
From room temperature
to 160 °C



Timer



INSTRUMENT - CODE

ECO 16	230 V / 50-60 Hz	F10100126
ECO 16	115 V / 50-60 Hz	F10110126



■ ECO 6

Intuitive and digital 6-position thermoreactor for Chemical Oxygen Demand (COD) with settable temperature and timer (up to 199 minutes). The unit automatically shuts down when the analysis time expires. The aluminum heating block offers optimum thermal conditions and a high level of homogeneity at all temperatures

INTUITIVE AND DIGITAL

ECO 6 ensures a simple programming of time (from 1 to 199 minutes or continuous) and temperature (from ambient to 200 °C).

VERSATILE

ECO 6 COD Thermoreactor has been originally designed to support \varnothing 42 mm tubes processing up to 6 x 200 ml, but thanks to smart reducer it can be used with 18 small tubes of 16 mm or 6 x 22 mm too.



Temperature range
From room temperature
to 200 °C



Timer



INSTRUMENT - CODE

ECO 6	230 V / 50-60 Hz	F10100120
ECO 6	115 V / 50-60 Hz	F10110120



■ ECO 25

Thermoreactor with 25 positions for Ø16mm vials that provide easy and intuitive programming of both time and temperature. The unit automatically shuts down when the analysis time expires. The aluminum heating block offers optimum thermal conditions and a high level of homogeneity at all temperatures

INTUITIVE AND DIGITAL

ECO 25 ensure a simple programming of time, selectable between four different options (30, 60, 120 minutes or continuous) and five temperatures (70, 100, 120, 150 and 160 °C).

SAFE

ECO 25 have a transparent test tube cover and various temperature safety features. The test tube extractor simplifies tubes handling.



Temperature range
70, 100, 120, 150 & 160



Timer



INSTRUMENT - CODE

ECO 25

115-230 V / 50-60 Hz

F101A0125



■ ECO 8

Thermoreactor with 8 positions for Ø16mm vials (plus 1 for Ø22mm vials) providing easy and intuitive programming of both time and temperature. The unit automatically shuts down when the analysis time expires. The aluminum heating block offers optimum thermal conditions and a high level of homogeneity at all temperatures

INTUITIVE AND DIGITAL

ECO 8 ensure a simple programming of time, selectable between four different options (30, 60, 120 minutes or continuous) and five temperatures (70, 100, 120, 150 and 160 °C).

SAFE

ECO 8 have a transparent test tube cover and various temperature safety features.



Temperature range
70, 100, 120, 150 & 160



Timer



INSTRUMENT - CODE

ECO 8

115-230 V / 50-60 Hz

F101A0127



ACCESSORIES - COD THERMOREACTORS

	ECO 6	ECO 16	ECO 8	ECO 25
A0000145 COD test tubes Ø 42x200 mm, 200 ml with cone NS 29/32, 3 pcs/box	•			
A00001041 Air condenser with ground cone	•			
A00001042 PTFE sheaths for 29/32 cones	•			
A00001043 Stainless steel handle for moving 6 test tubes Ø 42 mm simultaneously	•			
A00001045 Antisplash bell	•			
A00000362 Adapter for probe Ø 3 mm	•	•	•	•
A00001044 Anticorodal reducer Ø 42 mm with 3 holes Ø 16 mm	•			
A00001046 Articorodal reducer Ø 42 mm with 1 hole Ø 22 mm	•			
A00001051 Safety shield		•		
A00001039 ECO 25 Test tube extractor				•
10000002 Absorption attachment for condenser NS 29/32 for sludge analysis		•	•	•
CA0091636 Holder for 12 round glass cells		•	•	•
CA0091666 Test tube for sample decomposition Ø 22mm, NS 19/26 cone with glass cap for sludge analysis		•	•	•
CA0091667 Condenser 200 mm type KS with 3-meter polythylene tube for sludge analysis		•	•	•
CM0091680 Set of 20 glass test tubes with internal Ø 14 mm and external Ø 16 mm		•	•	•

BOD and Respirometers

■ RESPIROMETRIC Sensor System 6 BOD

The RESPIROMETRIC Sensor System BOD is designed to be a versatile solution with minimum footprint for aerobic degradation tests for industrial and domestic water quality testing.

- Ideal for: BOD5, BOD7, BOD Ultimate, assessment of disinfection on BOD.
- Biodegradation of monomers application to study the microbial activities involved in the production of plastics.
- Results reading in pressure (millibar) and BOD (mg/l).
- Easy-to-use and powerful sensor with 4 digit LED Display.
- Unique wireless control from your PC and VELP Ermes cloud platform.



Wireless DataBox™
and RESPIROSoft™



BOD Scales
90, 250, 600, 999, 4000 ppm

ermes enabled

INSTRUMENT - CODE

RESPIROMETRIC Sensor System 6	230 V / 50-60 Hz	SA10200146
RESPIROMETRIC Sensor System 6	115 V / 60 Hz	SA10210146
RESPIROMETRIC Sensor System 6 no Databox™	230 V / 50-60 Hz	SB10200146
RESPIROMETRIC Sensor System 6 no Databox™	115 V / 60 Hz	SB10210146

Included in the system: Stirring station, 500 ml amber bottles, KOH containers, stirring bars, DataBox™ and RESPIROSoft™ software.



■ RESPIROMETRIC Sensor System 6 Maxi BMP

The RESPIROMETRIC Sensor System Maxi BMP is designed to support anaerobic respiration studies to determine the Biochemical Methane Potential (BMP) of biomass. The BMP analysis studies the production of biogas from organic wastes mainly for Waste and Wastewater treatment and for Renewable Energy Production.

- Results reading in pressure (millibar) and automatic conversion in BMP value (NmLCH₄/gSV)
- The system is suitable also for other anaerobic studies such as Denitrification Tests (Requires 6 Denitrification glass bottles A00000410).
- Easy-to-use and powerful sensor with 4 digit LED Display.
- Unique wireless control from your PC and VELP Ermes cloud platform.



Wireless DataBox™
and RESPIROSoft™

ermes enabled

INSTRUMENT - CODE

RESPIROMETRIC Sensor System 6 Maxi	230 V / 50-60 Hz	SA10200156
RESPIROMETRIC Sensor System 6 Maxi	115 V / 60 Hz	SA10210156
RESPIROMETRIC Sensor System 6 Maxi no Databox™	230 V / 50-60 Hz	SB10200156
RESPIROMETRIC Sensor System 6 Maxi no Databox™	115 V / 60 Hz	SB10210156

Included in the system: Maxi stirring station, 1000 ml bottles, KOH containers, stirring bars, DataBox™ and RESPIROSoft™ software.



RESPIROMETRIC Sensor System 6 for Soil Analysis

The RESPIROMETRIC Sensor System for soil analysis is designed to support aerobic degradation tests on soil and compost. The analysis provides microbial soil respiration results from the mineralization of organic substances. A major application of these test is related to the detection and monitoring processes during decontaminations and clean-ups.

- The analysis is carried out directly on soil/compost in the 1000ml flask.
- Results reading in Pressure values (millibar).
- Easy-to-use and powerful sensor with 4 digit LED Display.
- Unique wireless control from your PC and VELP Ermes cloud platform.



ermes enabled



Wireless DataBox™
and RESPIROSoft™

INSTRUMENT - CODE

RESPIROMETRIC Sensor System for Soil Analysis	-	SA102B0176
RESPIROMETRIC Sensor System for Soil Analysis no Databox™	-	SB102B0176

Included in the system: 6 Kits soil analysis, DataBox™ and RESPIROSoft™ software.



RESPIROMETRIC Sensor System 6 for Plastic Biodegradability

The RESPIROMETRIC Sensor System for plastic biodegradability is designed to support aerobic degradation test for the determination of the degree of aerobic biodegradability of plastic materials, including those containing formulation additives, in an aqueous medium.

- Multistirrer Digital 6-positions to precisely set stirring speed and enable the lock feature to avoid unintentional modification of the stirring speed.
- Results reading in Pressure values (millibar).
- Easy-to-use and powerful sensor with 4 digit LED Display.
- Unique wireless control from your PC and VELP Ermes cloud platform.



ermes enabled



Wireless DataBox™
and RESPIROSoft™

INSTRUMENT - CODE

RESPIROMETRIC Sensor System for Plastic Biodegradability	100-240 V / 50-60Hz	SA102A0166
RESPIROMETRIC Sensor System for Plastic Biodegradability no Databox™	100-240 V / 50-60Hz	SB102A0166

Included in the system: Multistirrer Digital 6-positions, 6 Kits plastic biodegradability analysis, stirring bars, DataBox™ and RESPIROSoft™ software.



■ BOD Sensor

Innovative, mercury-free and extremely reliable solution for BOD analysis. The 6 and 10 position systems include the BOD sensors, stirring station, stirring bars and KOH traps.

PRECISE AND EASY TO USE

It can measure on scales of 90, 250, 600 and 999 ppm BOD.

SAFE

The IP 54 Protection Rating guarantee durability even in the most aggressive environments. Class 3 IEC 1010 conformity.

COMPACT DESIGN

BOD System 6 is designed to optimize space consumption inside cooled incubators.



INSTRUMENT - CODE

BOD Sensor	-	F102B0133
BOD Sensor Set	-	F102B0134



■ BOD Sensor System 6

Innovative, mercury-free and extremely reliable solution for BOD analysis. The 6 and 10 position systems include the BOD sensors, stirring station, stirring bars and KOH traps.

PRECISE AND EASY TO USE

It can measure on scales of 90, 250, 600, 999 and 4000 ppm BOD.

SAFE

The IP 54 Protection Rating guarantee durability even in the most aggressive environments. Class 3 IEC 1010 conformity.

COMPACT DESIGN

BOD Sensor System 6 is designed to optimize space consumption inside cooled incubators.



BOD Scales
90, 250, 600, 999, 4000 ppm

INSTRUMENT - CODE

BOD Sensor System 6	230 V / 50-60 Hz	SA10200136
BOD Sensor System 6	115 V / 60 Hz	SA10210136

Included in the system: Stirring station 6 positions, BOD Sensor, 500 ml amber bottles, KOH containers, stirring bars.



■ BOD Sensor System 10

The VELP RESPIROMETRIC Sensor is designed to provide a smart and cloud-enabled solution to laboratories of water and wastewater quality control, biological waste treatment plants, renewable energy production and environmental labs studying the effects of plastic and other pollutants in water and soils.

PRECISE AND CONVENIENT

It can measure on scales of 90, 250, 600, 999 and 4000 ppm BOD.

COMPACT DESIGN

BOD Sensor System 10 is designed to optimize space consumption inside cooled incubators.



BOD Scales
90, 250, 600, 999, 4000 ppm

INSTRUMENT - CODE

BOD Sensor System 10	230 V / 50-60 Hz	SA10200137
BOD Sensor System 10	115 V / 60 Hz	SA10210137

Included in the system: Stirring station 10 positions, BOD Sensor, 500 ml amber bottles, KOH containers, stirring bars.



ACCESSORIES - BOD AND RESPIROMETERS

	RESPIROMETRIC Sensor System 6 BOD	RESPIROMETRIC Sensor System 6 Maxi BMP	RESPIROMETRIC Sensor System 6 for Soil Analysis	RESPIROMETRIC Sensor System 6 for Plastic Biodegradability	BOD Sensor System
A00000135 Sensor Check	•	•	•	•	•
A00000136 Control Test Tablets, 10 pcs/box	•	•	•	•	•
A00000221 Multi-socket extension cable EU	•	•		•	•
A00000222 Multi-socket extension cable UK	•	•		•	•
A00000223 Multi-socket extension cable AU	•	•		•	•
10003083 Plug USA for power supply	•	•		•	•
10003084 Plug UK for power supply	•	•		•	•
10003085 Plug AU for power supply	•	•		•	•
A00000410 Denitrification glass bottle		•			
E00010012 VELP Ermes 1 year Connection	•	•	•	•	
E00010036 VELP Ermes 3 year Connection	•	•	•	•	

Cooled Incubators

■ FOC 200IL Connect (not available in USA, Mexico and Canada)

FOC 200IL Connect is the cloud-enabled illuminated cooled incubator ideal for plant growth, seed germination, cultivation, breeding of plants, insects and small animals, bacteria culturing, fermentation studies.

CONVENIENT AND EFFICIENT

FOC 200IL Connect is equipped with 2 lighted shelves and an internal transparent door.

EFFICIENT THERMOREGULATION

FOC 200IL Connect guarantees a perfect thermoregulation and stability thanks to the Auto-Tuning system. The use of forced ventilation uniforms the internal temperature.

EXCLUSIVE CONNECTIVITY

Premium Wi-Fi connectivity to VELP Ermes Cloud Platform. TEMPSoft™ software with 485 cable connection to constant monitor the instrument. MODBUS communications for PLC connection.



Total volume
169 L



Temperature range
From 3 to 50 °C



Auto-Tuning
technology
± 0.5°C



Timer
Lighting Cycles



ermes enabled

INSTRUMENT - CODE

FOC 200IL Connect

230 V / 50-60 Hz

F10400544*

* The cooled incubator is supplied with 2 shelves 40002722 and 1 shelf 10008039



■ FOC 200I Connect (not available in USA, Mexico and Canada)

FOC 200I Connect is the cloud-enabled cooled incubator with internal transparent door ensuring excellent temperature stability and homogeneity.

CONVENIENT AND EFFICIENT

FOC 200I Connect is equipped with an internal transparent door allowing sample monitoring with no temperature alteration.

EFFICIENT THERMOREGULATION

FOC 200I Connect guarantees a perfect thermoregulation and stability thanks to the Auto-Tuning system. The use of forced ventilation uniforms the internal temperature.

EXCLUSIVE CONNECTIVITY

Premium Wi-Fi connectivity to VELP Ermes Cloud Platform. TEMPSoft™ software with 485 cable connection to constant monitor the instrument. MODBUS communications for PLC connection.



Total volume
169 L



Temperature range
From 3 to 50 °C



Auto-Tuning
technology
± 0.5°C



ermes enabled

INSTRUMENT - CODE

FOC 200I Connect

230 V / 50-60 Hz

F10400543*

* The cooled incubator is supplied with 3 shelves 10008039



■ FOC 200E Connect (not available in USA, Mexico and Canada)

FOC 200E Connect is the cloud-enabled cooled incubator ensuring excellent temperature stability and homogeneity.

CONVENIENT AND EFFICIENT

FOC 200E Connect is asy to use thanks to the intuitive digital interface.

EFFICIENT THERMOREGULATION

FOC 200E Connect guarantees a perfect thermoregulation and stability thanks to the Auto-Tuning system. The use of forced ventilation uniforms the internal temperature.

EXCLUSIVE CONNECTIVITY

Premium Wi-Fi connectivity to VELP Hermes Cloud Platform. TEMPSoft™ software with 485 cable connection to constant monitor the instrument. MODBUS communications for PLC connection.



ermes enabled



Total volume
169 L



Temperature range
From 3 to 50 °C



Auto-Tuning
technology
± 0.5°C

INSTRUMENT - CODE

FOC 200E Connect

230 V / 50-60 Hz

F10300542*

* The cooled incubator is supplied with 3 shelves 10008039



■ FOC 120I Connect (not available in USA, Mexico and Canada)

FOC 120I Connect is the cloud-enabled cooled incubator with internal transparent door ensuring excellent temperature stability and homogeneity.

CONVENIENT AND EFFICIENT

FOC 120I Connect is equipped with an internal transparent door allowing sample monitoring with no temperature alteration.

EFFICIENT THERMOREGULATION

FOC 120I Connect guarantees a perfect thermoregulation and stability thanks to the Auto-Tuning system. The use of forced ventilation uniforms the internal temperature.

EXCLUSIVE CONNECTIVITY

Premium Wi-Fi connectivity to VELP Hermes Cloud Platform. TEMPSoft™ software with 485 cable connection to constant monitor the instrument. MODBUS communications for PLC connection.



ermes enabled



Total volume
109 L



Temperature range
From 3 to 50 °C



Auto-Tuning
technology
± 0.5°C

INSTRUMENT - CODE

FOC 120I Connect

230 V / 50-60 Hz

F10400541

* The cooled incubator is supplied with 2 shelves



■ FOC 120E Connect (not available in USA, Mexico and Canada)

FOC 120E Connect is the cloud-enabled cooled incubator ensuring excellent temperature stability and homogeneity.

CONVENIENT AND EFFICIENT

FOC 120E Connect is easy to use thanks to the intuitive digital interface.

EFFICIENT THERMOREGULATION

FOC 120E Connect guarantees a perfect thermoregulation and stability thanks to the Auto-Tuning system. The use of forced ventilation uniforms the internal temperature.

EXCLUSIVE CONNECTIVITY

Premium Wi-Fi connectivity to VELP Ermes Cloud Platform. TEMPSoft™ software with 485 cable connection to constantly monitor the instrument. MODBUS communications for PLC connection.



Total volume
109 L



Temperature range
From 3 to 50 °C



Auto-Tuning
technology
± 0.5°C



ermes enabled

INSTRUMENT - CODE

FOC 120E Connect

230 V / 50-60 Hz

F10300540

* The cooled incubator is supplied with 2 shelves



■ FTC 120 (not available in USA, Mexico and Canada)

Compact and efficient incubator specially designed for BOD respirometric measurement ensuring a constant 20°C temperature. FTC 120 is equipped with 2 internal sockets.

EFFICIENT THERMOREGULATION

The use of forced ventilation uniforms the internal temperature.



Total volume
109 L



Temperature
20 °C



Auto-Tuning
technology
± 0.5°C



INSTRUMENT - CODE

FTC 120

230 V / 50-60 Hz

F10300305

* The cooled incubator is supplied with 2 shelves



ACCESSORIES - COOLED INCUBATORS

	FOC 200IL Connect	FOC 200I Connect	FOC 200E Connect	FOC 120I Connect	FOC 120E Connect	FTC 120
A00000404 TEMPSoft with RS485 cable	•	•	•	•	•	
A00000405 Interconnection cable FOC Connect	•	•	•	•	•	
A00000406 IQ/OQ FOC Connect and FTC 120 Manual	•	•	•	•	•	•
A00000221 Multi-socket extension cable EU	•	•	•	•	•	•
A00000222 Multi-socket extension cable UK	•	•	•	•	•	•
A00000223 Multi-socket extension cable AU	•	•	•	•	•	•
10008039 Shelf for FOC 200, FOC 120, FTC 120	•	•	•	•	•	•
10008040 Bottom Shelf FOC 120, FTC 120				•	•	•
40002722 Lighted shelf for FOC 200 IL	•					
E00010012 VELP Ermes 1 year Connection	•	•	•	•	•	
E00010036 VELP Ermes 3 year Connection	•	•	•	•	•	



Flocculators

■ JLT 6

Easy to use and reliable digital flocculators with 6 positions, timer and illuminated back panel. JLT 6 is the ideal solution for Jar Testing 6 samples with the same speed and time settings.

RELIABLE

JLT guarantees a precise speed thanks to the electronically controlled motor. It also ensures a strong resistance to chemical and mechanical corrosion.

PRACTICAL

JLT has an illuminated back panel that simplifies the observation of the samples. All the stirring rods are adjustable in height without tools.



Stirring speed
From 10 to 300 rpm



Timer
From 0 to 999 min
From 0 to 99 hours

INSTRUMENT - CODE

JLT 6

100-240 V / 50-60 Hz

F105A0109



■ JLT 4

Easy to use and reliable digital flocculators with 4 positions, timer and illuminated back panel. JLT 4 is the ideal solution for Jar Testing 4 samples with the same speed and time settings.

RELIABLE

JLT guarantees a precise speed thanks to the electronically controlled motor. It also ensures a strong resistance to chemical and mechanical corrosion.

PRACTICAL

JLT has an illuminated back panel that simplifies the observation of the samples. All the stirring rods are adjustable in height without tools.



Stirring speed
From 10 to 300 rpm



Timer
From 0 to 999 min
From 0 to 99 hours

INSTRUMENT - CODE

JLT 4

100-240 V / 50-60 Hz

F105A0108



■ FC6S

Precise and easy to use flocculators with 6 independent positions that allow standard conditions to be adopted for Jar Test. FC6S has an illuminated back panel and adjustable stirring rods.

RESISTANT

Strong resistance to chemical and mechanical corrosion. Precise speed setting with the electronically controlled motor.

VERSATILE

With the FC6S, the same product can be submitted to different conditions in parallel, while the speed can be changed during the run.



Stirring speed steps
10 - 15 - 30 - 45 - 60 - 90
120 - 150 - 200 - 300 rpm

INSTRUMENT - CODE

FC6S

100-240 V / 50-60 Hz

F105A0112



■ FC4S

Precise and easy to use flocculators with 4 independent positions that allow standard conditions to be adopted for Jar Test. FC4S has an illuminated back panel and adjustable stirring rods.

RESISTANT

Strong resistance to chemical and mechanical corrosion. Precise speed setting with the electronically controlled motor.

VERSATILE

With the FC4S, the same product can be submitted to different conditions in parallel, while the speed can be changed during the run.



Stirring speed steps
10 - 15 - 30 - 45 - 60 - 90
120 - 150 - 200 - 300 rpm

INSTRUMENT - CODE

FC4S

100-240 V / 50-60 Hz

F105A0111



■ FP4

Portable flocculator with anti-skid base for stability, that allows standard conditions to be adopted for Jar Test. FP4 allows 4 samples to be processed in parallel. FP4 can be connected to a battery or a car cigarette lighter (12V).

RELIABLE

FP4 guarantees a precise speed thanks to an electronically controlled DC gear motor. It also ensures a strong resistance to chemical and mechanical corrosion.

PRACTICAL

FP4 is designed to be used on-site for immediate results. All the stirring rods are adjustable in height without tools.



Stirring speed steps
20 - 40 - 50 - 100 - 200 rpm



Timer
From 0 to 30 min

INSTRUMENT - CODE

FP 4

100-240 V / 50-60 Hz

F105A0117



ACCESSORIES - FLOCCULATORS

	JLT 6	JLT 4	FC6S	FC4S	FP4
A00001000 Plastic beaker 1000 ml	•	•	•	•	•
A00001001 Glass beaker 1000 ml	•	•	•	•	•
A00001002 Transparent plastic Imhoff cone	•	•	•	•	
A00001003 Glass graduated Imhoff cone	•	•	•	•	
A00001004 Stand for 2 Imhoff cones	•	•	•	•	
A00001005 Carrying case					•
A00000319 IQ/OQ Manual JLT	•	•			
A00000379 IQ/OQ FC4S - FC6S Manual			•	•	
10003722 Power supply cord, US plug	•	•	•	•	
10003723 Power supply cord, UK plug	•	•	•	•	
10003724 Power supply cord, AU plug	•	•	•	•	
10003083 Plug USA for power supply					•
10003084 Plug UK for power supply					•
10003085 Plug AU for power supply					•

Other Solutions

■ ROTAX 6.8 Overhead Mixer

Overhead mixer with LCD speed display, that offers excellent performance for all the applications where rotating, shaking and mixing are required. Rotax 6.8 is resistant to chemical and mechanical corrosion.

ACCURATE AND SAFE

Rotax 6.8 is designed to automatically stop if blocked. Moreover it is compliant with UNI 10802 and DIN 38414 standards.



Stirring speed
Up to 30 rpm



INSTRUMENT - CODE

ROTAX 6.8	230 V / 50-60 Hz	F10600118
ROTAX 6.8	115 V / 50-60 Hz	F10610118

For accessories visit online www.velp.com



■ OCB Open Circulating Baths

Efficient and precise open circulating bath that ensures excellent temperature homogeneity ($\pm 1^\circ\text{C}$), accurate control and thermostating of testing materials.

EASY TO USE

LCD display ensures a precise temperature setting. A wide choice of test tube racks is available.



Temperature range
From Room Temperature to 105 °C



Timer
From 0 to 24:59 hours



INSTRUMENT - CODE

OCB	230 V / 50-60 Hz	F40300240
OCB	115 V / 50-60 Hz	F40310240

For accessories visit online www.velp.com



■ Radiation Detector (not available in USA, Mexico and Canada)

Standard model of a Geiger-Müller tube with mica output window, able to detect α , β , γ and x-rays. Results are shown by a graduated scale, flashing LED and acoustic signal

EASY TO USE AND MULTIPURPOSE

It ensures an operating time of up to 2000 hours with one set of batteries and gives results in milliroentgens/hour and counts/minute (cpm) in 3 periods.

RELIABLE

The anti-saturation circuit reaches a value equivalent to 100 times the maximum reading in the maximum range.



INSTRUMENT - CODE

Radiation detector

For accessories visit online www.velp.com

R10800340



■ SP 311 Peristaltic Pumps

An easy to use and reliable peristaltic pump, ideal for transferring gas, liquids, mixtures and emulsions in various industries, able to pump from 10 meters depth.

EASY TO USE AND RELIABLE

Tubing resists most chemicals and ensures minimum maintenance. The electronic speed control makes simple the control of the instrument.



INSTRUMENT - CODE

SP 311/2	230 V / 50-60 Hz	F40200002
SP 311/6	230 V / 50-60 Hz	F40200006
SP 311/12	230 V / 50-60 Hz	F40200012
SP 311/60	230 V / 50-60 Hz	F40200060

For accessories visit online www.velp.com



■ TB1 Turbidimeter (not available in USA, Mexico and Canada)

Waterproof, precise and easy to calibrate portable turbidimeter that measures the turbidity of aqueous samples simply and accurately with nephelometric method.

RELIABLE AND PRECISE

Tb1 is supplied with 4 calibration standards (800, 100, 20 and 0.02 NTU) and can test up to 1200 samples with one set of batteries.

RESISTANT

IP 67 protection against ingress of particles and water.



INSTRUMENT - CODE

TB 1

R109B12150

For accessories visit online www.velp.com



■ JPV Recirculating Water Vacuum Pump

JPV pump ensures constant water recirculation and reduced water consumption. JPV resists to chemical corrosion and is ideal for applications where non-pulsing suction is needed.

QUALITY AND USABILITY

JPV provides vacuum where no reliable water supply is available and guarantees the absence of noise and vibrations. ABS structure guarantees high resistance to chemical corrosion.

EASY TO USE

The instrument has inset handles to simplify lifting and the stopcock for emptying the tank.



INSTRUMENT - CODE

JPV

230 V / 50-60 Hz

F40100541

JPV

115 V / 50-60 Hz

F40110541

For accessories visit online www.velp.com





ITALY – HQ

Via Stazione 16 20865 Usmate (MB) Italy
Tel. +39 039 628811 - velpitalia@velp.com

USA

40, Burt Drive, Unit #1, Deer Park - NY 11729 - U.S.
Tel. +1 631 573 6002 - velpusa@velp.com

CHINA

Building 28, Lane 1333, Xinlong road, Minhang district, Shanghai
Tel. +8621 34500630 - velpchina@velp.com

INDIA

velpindia@velp.com

LATAM

velplatam@velp.com



We reserve the right to make technical alterations
We do not assume liability for errors in printing, typing or transmission

VELP Official Partner

DESIGNED AND MANUFACTURED IN ITALY