

Astronaut CL

Owner's Manual



Cetacea Sound

Technical Audio for the 21st Century Classroom

OWNER'S MANUAL

For use with the following Astronaut CL systems.
System No.: ASTRO-CLW001 | ASTRO-CLD001 | ASTRO-CLR001

Index

Contact Info

CETACEA SOUND CORP
2003 East Center Circle
Plymouth, Minnesota 55441

SALES
sales@cetaceasound.com

CUSTOMER SERVICE
customerservice@cetaceasound.com

PHONE
(763) 559-1019

U.S.A., Canada, and Caribbean
(800) 556-1922

FAX
(763) 559-1585

ONLINE
www.cetaceasound.com

Online Resources



NEWS CENTER
Announcements
& Events



EMAIL / RSS
News Delivered
Your Way



SUPPORT
Documentation
& Resources

A	GETTING STARTED	2-5
	Important—Read First	2
	Shipping Kit Contents	3
	Astronaut Up Close	4
	Safety Precautions	5
B	INSTALLATION	6-17
	Installer Notes	6
	Cabling Options	7
	Ceiling Mount Instructions	8-13
	Source Connections	14-15
	Power Connection	16-17
C	TECHNICAL SUPPORT	18-20
	Troubleshooting Guide	18-19
	Contact Info	20
D	LIMITED WARRANTY	21

IMPORTANT—READ FIRST

The Astronaut is an amplified speaker

Astronaut branded speaker systems are amplified and designed to plug into either mono or stereo sources of sound. Please check the model number of your speaker for input specifications.

Common Sources

Computer

Projector

Microphone

DVD / VHS

Interactive Whiteboard

CD / iPod® / iPad®

The Astronaut has a built-in amplifier. Connect to fixed or variable line level sources only.

Turn OFF special effects

When using an electronic source, turn off all equalizer or compression algorithm effects, commonly called “bass boost”, “surround sound”, “jazz”, etc. If connecting to a computer, make sure that the sound card software is properly set up for uncompressed and un-boosted stereo output. Use only the stereo output from DVD’s and personal computers. The Astronaut is not designed to plug into third party amplifiers, pre-amps, or subwoofer output jacks. Most line and variable headphone jacks are suitable sources.

iPod® and iPad® are registered trademarks of Apple Inc.

Getting Started

SHIPPING KIT CONTENTS

Please check that you have all of the following items. If any items are missing, please contact Cetacea Sound directly at (800) 556-1922.

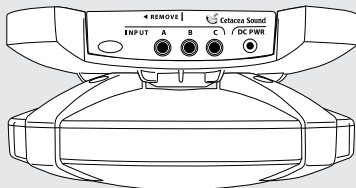
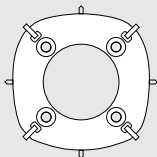
 Astronaut CL Speaker

 Ceiling Mount Kit

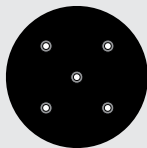
Mounting Bracket



Ceiling Plate



Eye Bolt



Aluminum Bolts (4)

Power Supply

1 of the following 3 power supply (PS) packages is included with your system. Refer to the original order documentation for system number (S/N).

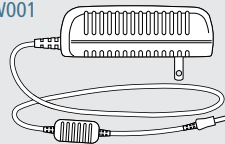
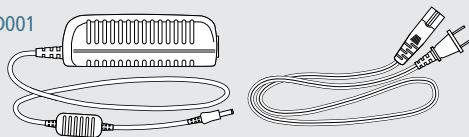
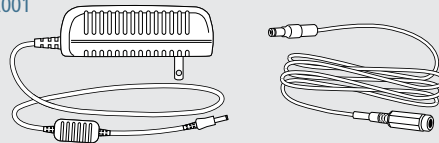
 S/N: ASTRO-CLW001
Wall Mount PS

 S/N: ASTRO-CLD001
Desktop PS

 S/N: ASTRO-CLR001
Wall Mount PS
w/ 30' Ext. Cable

Getting Started

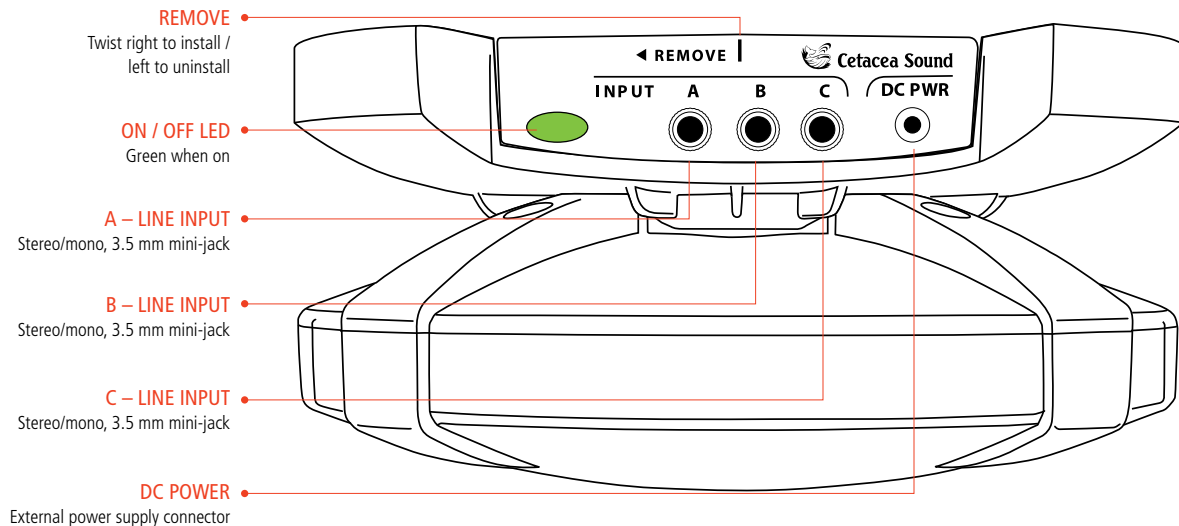
ASTRONAUT UP CLOSE

A



SAFETY PRECAUTIONS

Follow these instructions & use precautions

- Safeguard this equipment from high humidity conditions.
- Read the instructions completely prior to attaching the speaker overhead.
- Take special care to not drop the equipment while mounting to the ceiling.
- Heed to all cautions and warnings posted within this guide and on the speaker equipment.
- When not using the equipment for long periods of time, e.g. one month or longer, disconnect the power supply. The Astronaut has over-voltage and diode protection built in; however, it is best to err on the side of caution.
- Never force anything into the openings or source inputs of the speaker equipment.
- Do not use this equipment if it shows obvious signs of damage from shipping or dropping.
- Do not use this equipment if ambient temperatures exceed 120 °F (48 °C).
- Make sure equipment is properly mounted according to the Ceiling Mount Instructions found in this guide. This is the only approved method of installation; any other may cause a loss in warranty.

NOTE

All literature can be found on our website. Please download an electronic copy of this guide for your records.

Input source specifications

Stereo Sources

Maximum input voltage should not exceed 300 mV per input channel (A, B, or C). Do not use any multi-channel sources like 3-channel, Dolby Digital 5-channel, THX, or Q-Sound.

Mono Sources

Maximum input voltage should not exceed 150 mV per input channel (A, B, or C). Use microphones that offer a mono or stereo line output instead of microphone level output. Cetacea Sound microphones are compatible with the Astronaut. Use of other brands may result in unpredictable results and is not advised.

Line Level Sources

Although preamps, projector outputs, and music mixers are popular, it is possible to “overdrive” the Astronaut with these devices, leading to premature failure and a loss of warranty coverage.

Additionally, equalizers, bass boost, surround sound, QSound, spatializer, and other compression techniques are not necessary and will add nothing to the sound quality. This can also “overdrive” the Astronaut, leading to failure and a loss of warranty coverage.

Recommended assembly tools

The following tools are recommended to mount the Astronaut to a suspended ceiling tile.

- Phillips head screwdriver
- Hand drill with ¼" and ½" bits
- Measuring tape

CABLING OPTIONS

Cetacea Sound offers a variety of source and power cabling options to best support your specific installation project. Please ensure that all source and power cables are procured prior to installation. Please visit our website for ordering information.

Power Extension Cables

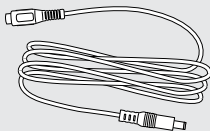

 AC Extension Cables

Lengths: 6' | 10' | 20' | 30'

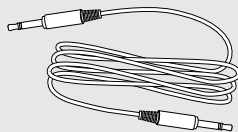

 DC Extension Cables

Lengths (non-plenum): 6' | 10' | 20' | 40'
Lengths (plenum): 20' | 40'

Source Cables

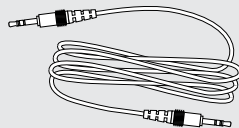

 Mono Cables, M-M

Length: 6'

 Stereo Cables, M-M

Lengths: 3' | 20'

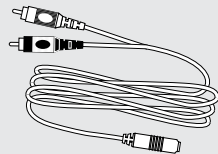
RCA Adapter

 RCA to 3.5 mm, M-F

Length: 6'

Volume Control

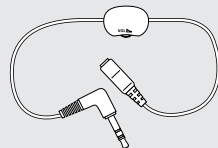

 In-line Volume Control, M-F

CEILING MOUNT INSTRUCTIONS

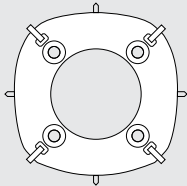
Ceiling Mount Kit

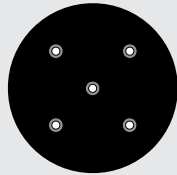

Mounting Bracket



Ceiling Plate



Eye Bolt

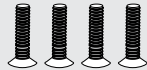

Aluminum Bolts (4)

STEP 1

Determine Speaker Location

The Astronaut is very forgiving and does not need to be in the center of the room for the best sound quality. Typically, installers choose a location near the projector in order to share the same power source in the ceiling. Try to maintain at least 4' of space from the nearest wall or vertical obstruction.

 **CAUTION**

- Install speaker away from direct heat, high humidity, and physical obstructions.
- Do not install the Astronaut speaker near a projector exhaust port or fan. The hot air from the projector can cause the Astronaut to overheat and fail.

CEILING MOUNT INSTRUCTIONS

STEP 2

Tap Holes Into Ceiling Tile

Remove a ceiling tile and set it on a firm surface. Use the ceiling plate as a guide to mark all 5 holes at locations **A** and **B**.

Drill or tap $\frac{1}{4}$ " holes at location **A** for the provided 4 aluminum bolts. Drill or tap a $\frac{1}{2}$ " hole at location **B** in the ceiling surface for the security eye bolt.

Above Ceiling Cabling *(optional)*

If cables will be routed above the ceiling, cut a 1" hole into the ceiling tile approximately 6" away from where the front of the speaker will be.

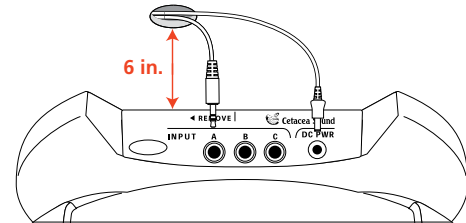
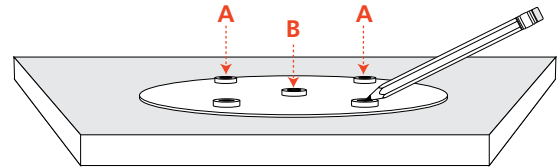
Diagrams

CEILING MOUNT INSTRUCTIONS

STEP 3

Mount Ceiling Plate and Bracket

Using the provided 4 aluminum bolts, fasten the ceiling plate **C** to the top of the ceiling tile and ceiling bracket **D** to the bottom of the ceiling tile. The bolts should be secured snugly; do not over-tighten.

For Solid Ceiling Surfaces Only *(optional)*

The Astronaut also installs to hard surface ceilings. In this case, Ceiling Plate **C** and the security eyebolt are not needed. Prior to installing the Ceiling Bracket **D**, clip off the small teeth from the ceiling side of the bracket using a pair of diagonal pliers. Fasten Ceiling Bracket **D** using the appropriate screws for the ceiling surface material, like wood or plaster screws.

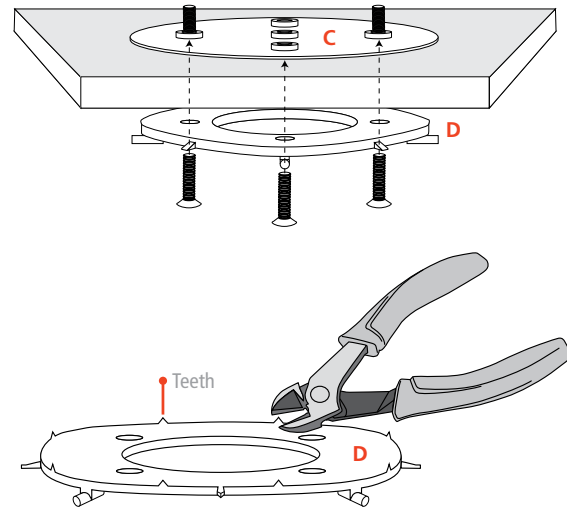
Diagrams

CEILING MOUNT INSTRUCTIONS

STEP 4

Mount Astronaut Speaker

- a. Mount the Astronaut speaker to the ceiling bracket. Use a finger to locate the first peg **E**. Align this peg with one of the four holes **F** on the speaker base. All other pegs will fall into place accordingly.

NOTE

Make sure all 4 pegs are aligned and the speaker is flush to the ceiling prior to the step below.

- b. Twist the speaker slightly to the right until you hear it lock. Once locked, the ceiling bracket pointer **G** will line up with the line-guide on the speaker lens.

HINT

It only takes light pressure to lock the speaker—no more than it would to click a pen.

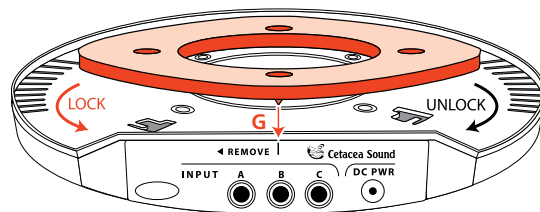
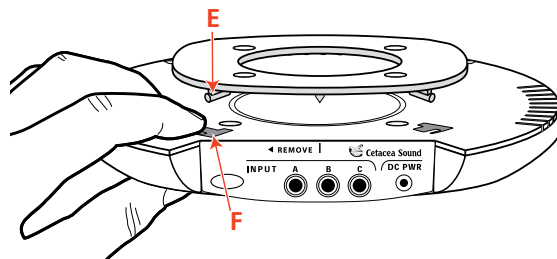
Diagrams

CEILING MOUNT INSTRUCTIONS

STEP 5

Lock Astronaut Speaker with Security Eye Bolt

Once the speaker is attached to the ceiling bracket, screw the eyebolt **H** through the top of the ceiling plate **I** and into the Astronaut base.

NOTE

The eye bolt prevents the Astronaut from being removed from below the false ceiling without first unscrewing it.

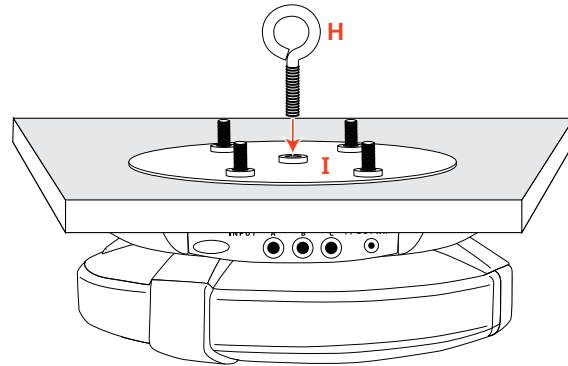
Diagram

B

Installation

CEILING MOUNT INSTRUCTIONS

STEP 6

Secure Astronaut to Ceiling Truss *(optional)*

If desired, use a suspension wire (not supplied) to attach the eye bolt to the ceiling truss.

Diagram

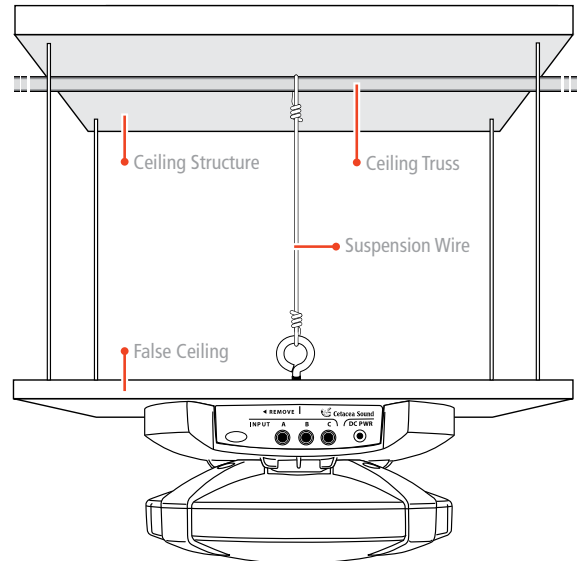

Connect A/V equipment to the Astronaut

The Astronaut can be hooked up to a variety of different A/V devices. Please use high quality stereo/mono cables (3.5 mm mini jacks) when connecting your source equipment. The Astronaut has a built-in 3-channel mixer that accepts up to 3 simultaneous devices (A, B, C).

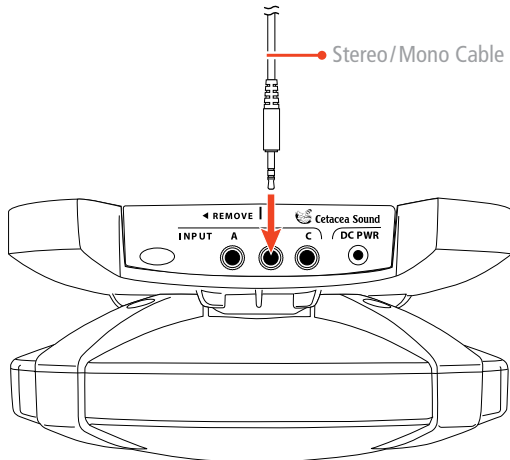

Common Sources

Projector	Microphone
DVD / VHS	Interactive Whiteboard
CD / iPod® / iPad®	Computer

Volume Control

When using a variable output, e.g., projector audio output, control the volume level at the source. When using a fixed audio output, an in-line volume control or mixer must be used to adjust the volume (sold separately).

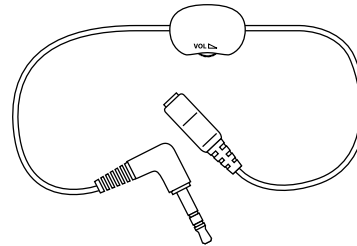

In-line Volume Control

SOURCE CONNECTIONS

Connection diagrams

Fixed Output | VCR/DVD Connections

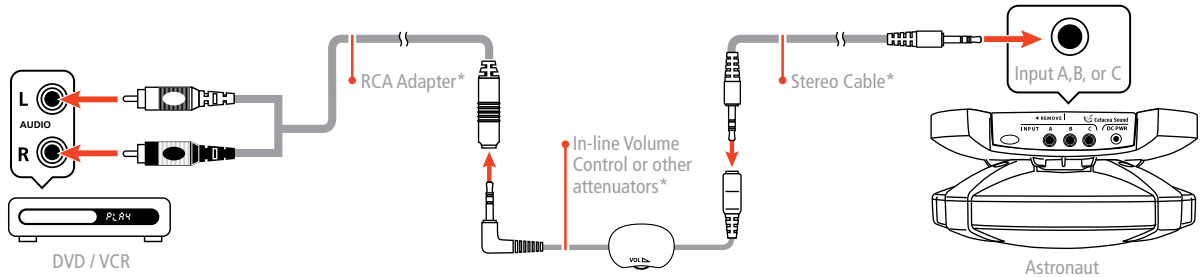

* Source cables sold separately.

Variable Output | Projector Connections

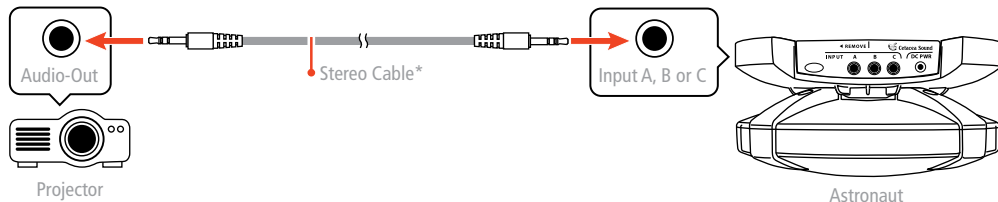

STEP 1

High Voltage Connection

CAUTION

Do not connect speaker to power until ceiling installation is completed and at least one source cable is connected.

Wall Mount Power Supply

Choose this power supply when the AC outlet is near the mounting location. Typically, the power source is shared with and located near a projector.

Desktop Power Supply

Choose this power supply when the AC outlet location requires AC power extension cables or international plugs.

NOTE

We offer optional length power cords for long-run applications and other custom installations. (See pg. 7)

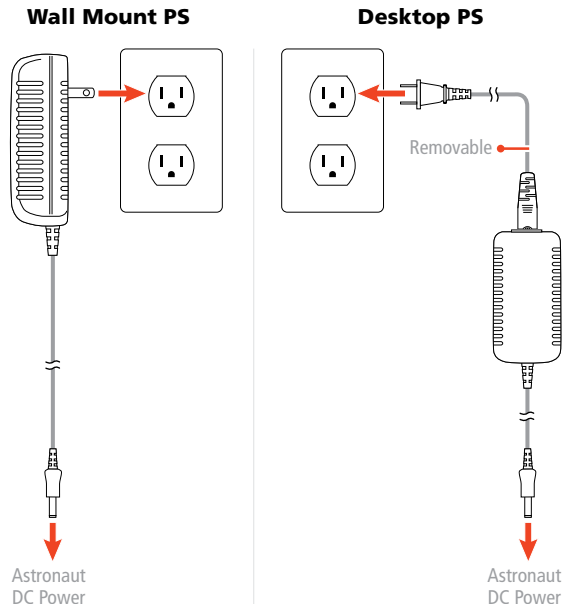

POWER CONNECTION

STEP 2

Low Voltage Connection

The low power barrel connector **J** can now be plugged into the speaker. Plugging/unplugging this connector will turn the speaker on and off.

STEP 3

Power Up

When the power supply connector barrel is plugged into the speaker the internal green light **K** will turn on, indicating the speaker is on.

Turn on your sound source and adjust the volume.

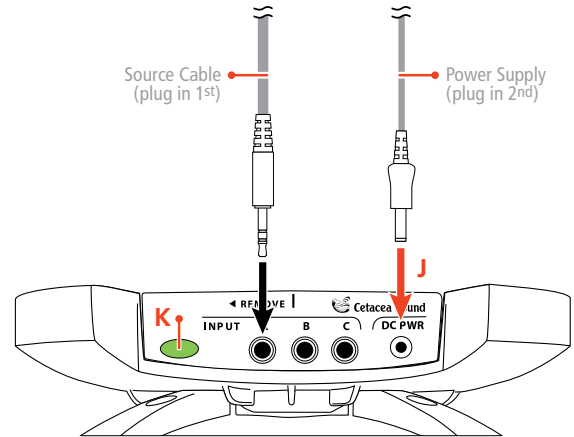
Diagram**CAUTION**

Make sure all source cables are connected before plugging in power barrel.

This guide covers the most common issues encountered with powered speakers. Perform this self-diagnostic procedure prior to contacting us; it will help us further diagnose any problem you are experiencing.

Most speaker difficulties result from:

- Poor connections
- Poor audio sources
- Incorrect or unapproved power supplies

STEP 1

Check Connections

- Make sure the power supply is fully plugged into the power outlet and correct speaker terminal.
- Make sure the audio source connections (CD, DVD, PC, microphone, etc.) are fully plugged into the correct speaker terminal.
- Make sure all connections are tight otherwise noise may occur.

STEP 2

Source Diagnostics

a. Computers and Laptops

Please refer to your computer's documentation.

- Make sure the volume set on your computer is turned up at least 50%.
- Make sure CD/DVD's or MP3 files are playing through your computer speakers before connecting Cetacea Sound speakers.

b. Other Source Devices

Test multiple audio sources to isolate a device problem.

- If you hear sound with one source device but not another, then the sound source is faulty.
- For faulty computers: the headphone or line-out jack is not set up correctly in the computer software. Refer to your computer's documentation.

STEP 3

Check Power

Verify that the green light **L** is on at the speaker input panel. Verify the sound source is "ON" and playing.

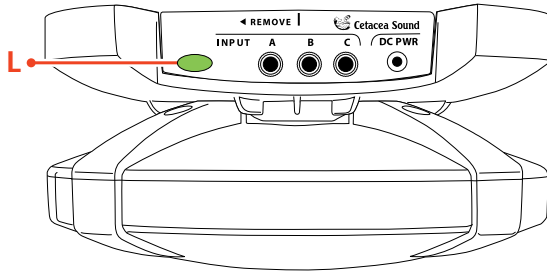
**TIP**

In the case that your power supply fails, please recycle it according to local laws. Older supplies can be returned to us for a 25% discount on a new ENERGY STAR® model.

DOs & DON'Ts

Don't use unapproved power supplies. They could permanently damage the amplifier or other components in your speaker.

Do educate all users in the proper use and handling of electronic equipment, especially wires and cables.



Technical Support Team

Troubleshoot your product by visiting the Support section of our website. Here you can troubleshoot your product and find useful installation tips. If you are still experiencing problems, please contact our Technical Support team.

Monday to Friday
8:00 a.m. – 5:00 p.m. CST

(763) 559-1019 or (800) 556-1922

customerservice@cetaceasound.com

D

Limited Warranty

FULL 2-YEARS ON ALL COMPONENTS

Cetacea Sound Corp. warrants to the original purchaser that, if the product purchased from an authorized Cetacea Sound Dealer fails in normal use due to defect in materials or workmanship within two years of the date of the original purchase, Cetacea Sound Corp. or a designated authorized partner will, at its option, repair or replace the product without charge. Products repaired or replaced are warranted for the remainder of the original warranty period.

THIS LIMITED WARRANTY DOES NOT COVER defects caused by freight damage; abuse; inappropriate use; exposure to extreme temperatures, solvents or other liquids, or foreign particles or contaminants; modification; alteration; accident or casualty; malfunction resulting from the malfunction of other audio equipment; operation of the product in a manner contrary to the instructions accompanying the product; repair or service by anyone other than Cetacea Sound Corp. or a designated authorized partner; or poor sound quality or noise due to poor cable quality, installation or routing, power fluctuations, improper grounding, or failure to follow the published installation guidelines of the International Communications Industry Assoc. (ICIA).

ANY EXPRESS WARRANTY NOT PROVIDED IN THIS LIMITED WARRANTY STATEMENT, AND ANY REMEDY FOR BREACH OF CONTRACT THAT, BUT FOR THIS PROVISION, MIGHT ARISE BY IMPLICATION OR OPERATION OF LAW, IS HEREBY EXCLUDED AND DISCLAIMED. IMPLIED WARRANTIES OF

MERCHANTABILITY AND OF FITNESS FOR ANY PARTICULAR PURPOSE ARE HEREBY DISCLAIMED. SOME STATES OR COUNTRIES DO NOT ALLOW LIMITATIONS ON HOW LONG AN IMPLIED WARRANTY LASTS, SO THIS LIMITATION MAY NOT APPLY TO YOU.

UNDER NO CIRCUMSTANCES SHALL CETACEA SOUND CORP. BE LIABLE TO PURCHASER OR ANY OTHER PERSON FOR ANY SPECIAL OR CONSEQUENTIAL DAMAGES, WHETHER ARISING OUT OF BREACH OF WARRANTY, BREACH OF CONTRACT OR OTHERWISE. SOME STATES OR COUNTRIES DO NOT ALLOW THE EXCLUSION OR LIMITATION OF INCIDENTAL OR CONSEQUENTIAL DAMAGES, SO THE ABOVE LIMITATION OR EXCLUSION MAY NOT APPLY TO YOU.

To obtain Warranty Service, the customer must contact Cetacea Sound if purchased in the USA or a designated authorized partner if purchased outside the country. For customers within the USA, follow the instructions shown on our website and return the product to us at the address shown below with the Return Material Authorization number issued by customer service. All removal, installation, and shipping expenses are the responsibility of the purchaser.

This Warranty gives you specific legal rights, and you may also have other rights which vary between states and countries outside the USA.



Cetacea Sound

© 2013 Cetacea Sound Corp. All rights reserved. Covered by multiple international patents.
All audio products are proudly made in the U.S.A. 

(7/13) 200905-017