

Elite Rack

Instruction Sheet

Thank you for purchasing a Raxxess Elite rack. After following these few short steps, you will find this to be an excellent value in a quality 19" EIA rack.

Step 1: Unpack the parts. Please be careful opening the carton. (A knife that is inserted too far may scratch the parts, and the staples are sharp!)

Content list:

2 pieces rack top and bottom (similar pieces)
2 pieces rack sides (again similar to each other, except they are left and right)

2 pieces rack rails: black metal rails as in the illustration

12 k/d studs: chrome "screw-like" studs

12 cams : cylinder shaped metal fittings

10 5/8" black wood screws

On slant racks only: 1 brace, 2-2" long wood screws & hex key

On 16, 20, and 24 space racks: 4 casters, and 16- 5/8" wood screws.

Lay the parts out on a table, or on the floor.

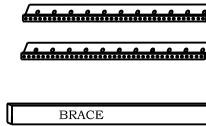
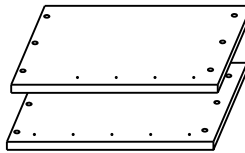
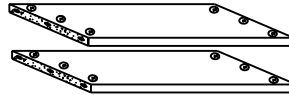

Step 2: Lay the sides near each other with the pilot holes (very small holes on what will be the insides) facing up. Screw one rack rail to each of the sides, using the short wood screws, one in each pilot hole (you may not use all of the screws, depending on the size of the rack).

Be sure to use the larger (1/4") holes in the rack rail, and that the tapped (threaded) holes are facing the front of the rack.

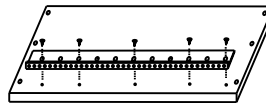
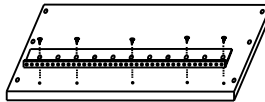

Step 3: Screw the studs into the sides, locating them in the white plastic inserts in the sides, as in Illustration 2.

Next, install the cams in the top and bottom, as shown in Illustration 3.

If you are assembling a slant-front rack, continue with Step 4. If you are assembling a straight front rack, skip to step 5.

Step 4: Install the brace on the bottom part of the rack (it has 16 small holes on its underside, where you'll attach the casters later). The brace screws onto the front edge of the bottom piece, facing the side opposite the 16 small holes, as shown in Illustration 4.

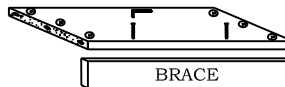
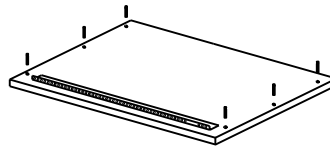

Step 5: Place one of the sides with the studs facing up as shown in Illustration 5. Drop the top and bottom parts down on it from above as shown.

Be sure to orient them correctly, so that the caster holes on the bottom piece are on the bottom, and that the top has no holes facing up. Turn the cams clockwise, so as to tighten the top and bottom in place, then add the second side to this assembly, and tighten the cams in the same manner.

Touchboards

205 Westwood Ave, Long Branch, NJ 07740

Phone: 866-94 BOARDS (26273) / (732)-222-1511

Fax: (732)-222-7088 | E-mail: sales@touchboards.com

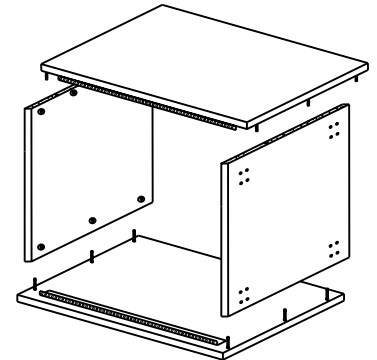

Step 6: If you have a rack that comes with casters, (16 RU and taller) stand the rack upside down, with the caster holes facing up, and screw the casters in place, using the (16) 5/8" wood screws, (4) in each caster.

Step 7: You may find it easiest to install your rack gear in your new rack with the rack on it's back, dropping the products in (carefully), and then screwing them to the rack rail, loosely at first, then tightening the screws when all of the products are properly oriented.

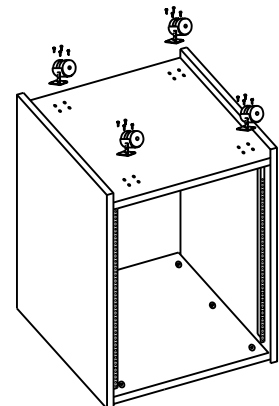

Instruction Sheet for Elite Series Racks: ERK-12-20, ERK-16-20 and ERK-20-20

Thank you for purchasing a Raxxess Elite rack.
After following these few short steps, you will find
this to be an excellent value in a quality 19" EIA rack.

Step 1: Unpack the parts. Please be careful opening the
carton. (A knife that is inserted too far may scratch the
parts, and the staples are sharp!)

Content list:

- 2 pieces rack top and bottom (similar pieces, except
the bottom has a plastic grommet for cable passage)
- 2 pieces rack sides (again similar to each other, except
they are left and right)
- 1 brace (slim wood part)
- 2 pieces rack rails: black metal rails as in the
illustration
- 14 k/d studs: chrome "screw-like" studs
- 14 cams : cylinder shaped metal fittings
- 10 5/8" black wood screws
- 4 casters, and 16- 5/8" wood screws.
- 1 plexi door (front) with 2 brass hinges
- 1 solid door (rear) with 2 chrome hinges

Lay the parts out on a table, or on the floor.

Step 2: Lay the sides near each other with the pilot
holes (very small holes on what will be the insides)
facing up.

Screw one rack rail to each of the sides, using the short
wood screws, one in each pilot hole (you may not use
all of the screws, depending on the size of the rack).
Be sure to use the larger (1/4") holes in the rack rail,
and that the tapped (threaded) holes are facing the
front of the rack.

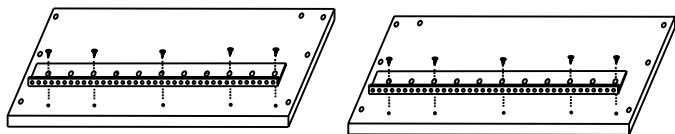
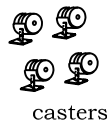
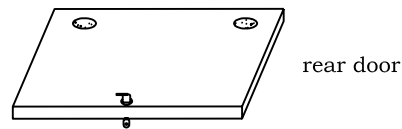
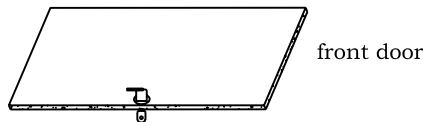
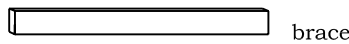
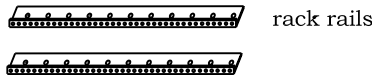
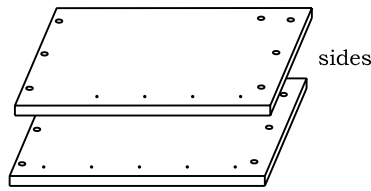
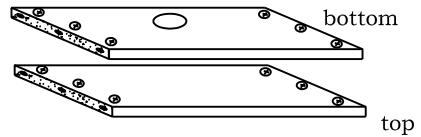

Illustration 1

Step 3: Screw the studs into the sides, locating them
in the white plastic inserts in the sides, as well as a
stud for the brace, as in Illustration 2.
Next, install the cams in the top and bottom, as shown
in Illustration 3.

Step 4: Place one of the sides with the studs facing up
as shown in Illustration 4. Drop the top and bottom
parts, as well as the brace down on it from above as
shown.

Be sure to orient them correctly, so that the caster
holes on the bottom piece are on the bottom, and that
the top has no holes facing up. Turn the cams
clockwise, so as to tighten the top, bottom and brace
in place, then add the second side to this assembly,
and tighten the cams in the same manner.

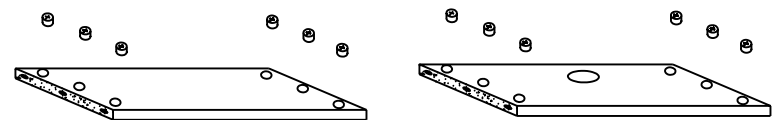
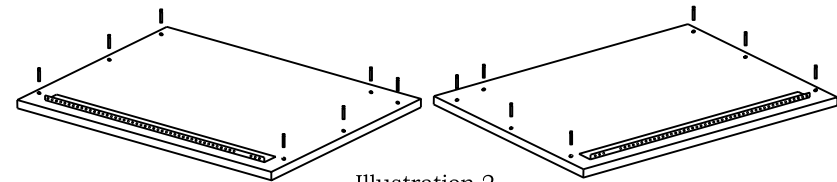

Illustration 3

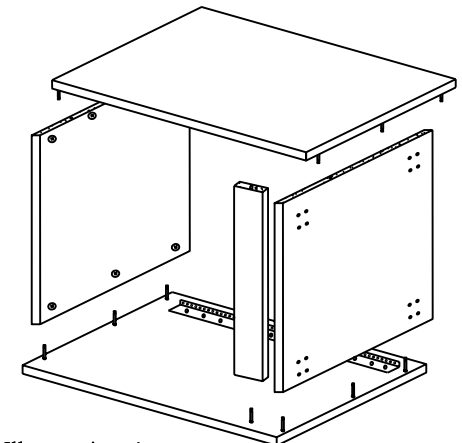

Illustration 4

C:\WINDOWS\TEMP\A\$C11AB4C8A.DIB

261 Buffalo Avenue
Paterson, N.J. 07503
Made with pride in the U.S.A.

Instruction Sheet for Elite Series Racks: ERK-12-20, ERK-16-20 and ERK-20-20

Page 2 of 2

Step 5: Now let's prep the doors. The rear door is a solid melamine door with a lock in it. It is pre-drilled for the 2 chrome hinges supplied. The "dish" (round) portion of the hinge fits in the large round hole in the rear door, and the (2) #8 x 3/8" wood screws go into the appropriate pilot holes. See Illustration 6.

The other part of the hinge attaches to the inside of the rack, at the rear. Before you attach this section, be sure to attach it to the correct side of the rack (you can install it so that the door swings either way). Locate the second hinge sections in the holes at the rear, tap them into the holes lightly (they can go in either direction), then run the attached screws in. You can put the door on later. Next, attach the "lock catch"- the small "L" shaped bracket- with 2 5/8" wood screws. See Illustration 7.

The front door is a smoked plexi-glass door, which mounts on either side (again, decide which direction works best for your location). When you know which way you'll hinge the door, mount the (2) brass door hinges on the inside of the front of the rack, on the side you've chosen. Be sure to mount them so that the openings are facing each other, so as to allow the door to fit between them. Screw them in place with the same #10 x 5/8" wood screws that you used for the rack rail, leaving the screw a bit loose, until you get the door in place. Slide the door between the hinges, then when it is all the way in, *lightly* tighten the screws on the door with a straight screwdriver, then tighten the hinge screws.

You should now stand the rack up and attach the rear door. This is done by placing the hinge section from the door on top of the section in the rack, and snapping the hinge together. To remove the door, simply pull on the release at the end of the hinge. Next, adjust the doors, so that they swing and lock correctly. The rear door has an adjustable hinge, which allows for left and right alignment, as well as in and out movement. Just turn the adjustment screws to see which screw moves the door in the correct direction. The front door should not require adjustment, but you can "tweak" it a bit of needed.

You also may need to remove the front door until you get your gear in the rack. To do this, loosen the "slotted" screw on each hinge to release the door.

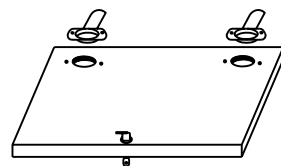

rear door

Illustration 6

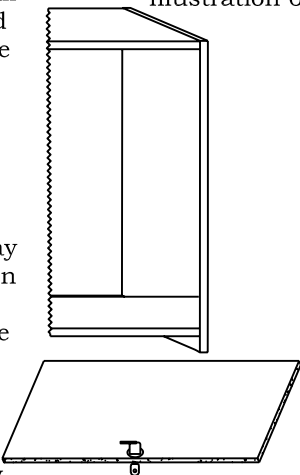

front door

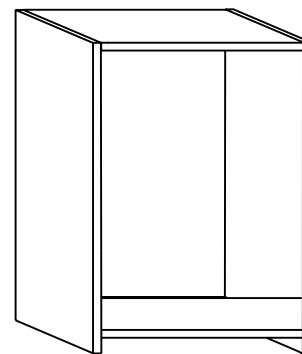

Step 6: The last thing to do is to (carefully, with carpet or something soft) stand the rack upside-down, with the bottom facing up, and screw on the casters. You will see the (16) "pilot" holes. they are merely guides as to where to place the casters, and they only serve as a starting point for the wood screws to bite into the wood.

We suggest that the easiest method for installing the gear (although it may not always be practical), is to do this with the rack on its back, with the rear door locked, and the front door removed. If you can carefully place the gear in the rack, orient the gear so that the spacing seems right, then run all of the rack screws (not supplied) into the rails, loosely at first, then tighten after one more alignment check.

Touchboards

205 Westwood Ave, Long Branch, NJ 07740
Phone: 866-94 BOARDS (26273) / (732)-222-1511
Fax: (732)-222-7088 | E-mail: sales@touchboards.com