

# INSTALLATION INSTRUCTIONS

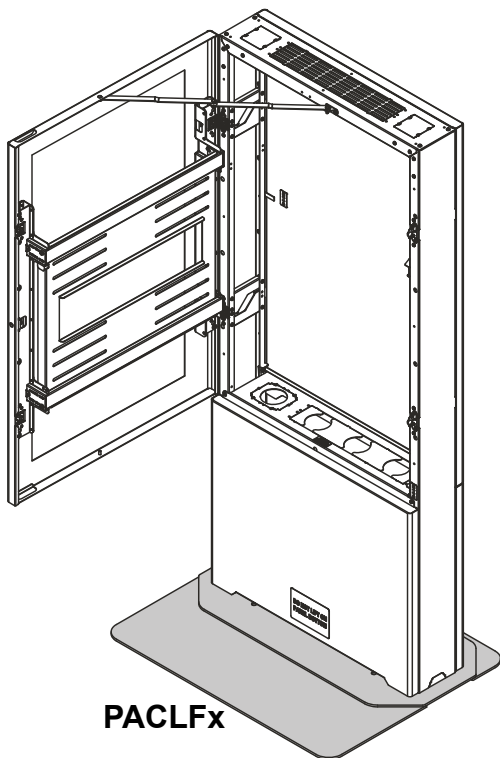

PACLFX

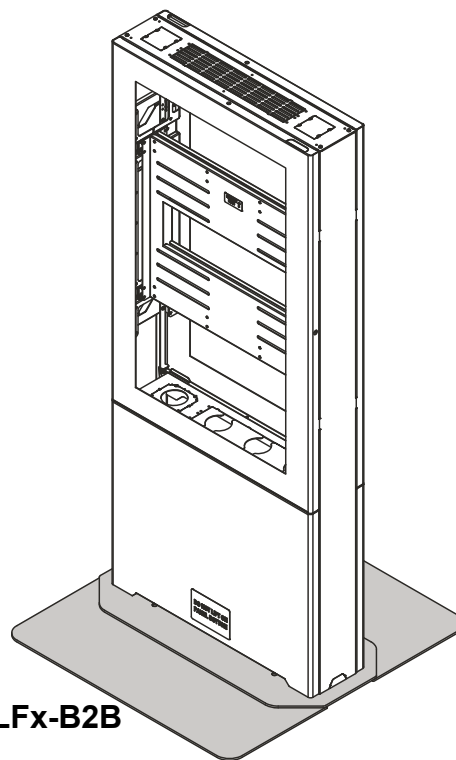

PACLFX-B2B

---

**55" to 40" Free-Standing Kiosk Base/  
55" to 40" Free-Standing Kiosk Back-to-Back Base**

---

## DISCLAIMER

Legrand | AV and its affiliated corporations and subsidiaries (collectively "Legrand | AV"), intend to make this manual accurate and complete. However, Legrand | AV makes no claim that the information contained herein covers all details, conditions or variations, nor does it provide for every possible contingency in connection with the installation or use of this product. The information contained in this document is subject to change without notice or obligation of any kind. Legrand | AV makes no representation of warranty, expressed or implied, regarding the information contained herein. Legrand | AV assumes no responsibility for accuracy, completeness or sufficiency of the information contained in this document.

Chief® is a registered trademark of Legrand AV Inc.

## DEFINITIONS

**MOUNTING SYSTEM:** A MOUNTING SYSTEM is the primary Chief product to which an accessory and/or component is attached.

**ACCESSORY:** AN ACCESSORY is the secondary Chief product which is attached to a primary Chief product, and may have a component attached or setting on it.

**COMPONENT:** A COMPONENT is an audiovisual item designed to be attached or resting on an accessory or mounting system such as a video camera, CPU, screen, display, projector, etc.



**WARNING:** A WARNING alerts you to the possibility of serious injury or death if you do not follow the instructions.



**CAUTION:** A CAUTION alerts you to the possibility of damage or destruction of equipment if you do not follow the corresponding instructions.



## IMPORTANT SAFETY INSTRUCTIONS



**WARNING:** Failure to read, thoroughly understand, and follow all instructions can result in serious personal injury, damage to equipment, or voiding of factory warranty! It is the installer's responsibility to make sure all accessories are properly assembled and installed using the instructions provided.



**WARNING:** Failure to provide adequate structural strength for this accessory can result in serious personal injury or damage to equipment! It is the installer's responsibility to make sure the structure to which this accessory is attached can support five times the combined weight of all equipment. Reinforce the structure as required before installing the accessory.



**WARNING:** Use this accessory only for its intended use as described in these instructions. Do not use attachments not recommended by the manufacturer.



**WARNING:** Never operate this accessory if it is damaged. Return the accessory to a service center for examination and repair.











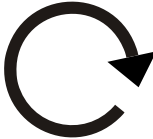

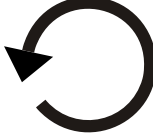
**WARNING:** Do not use this accessory outdoors.

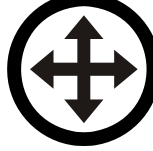
**--SAVE THESE INSTRUCTIONS--**



**LEGEND**

	<p><b>Tighten Fastener</b></p> <p>Apretar elemento de fijación</p> <p>Befestigungsteil festziehen</p> <p>Apertar fixador</p> <p>Serrare il fissaggio</p> <p>Bevestiging vastdraaien</p> <p>Serrez les fixations</p>		<p><b>Pencil Mark</b></p> <p>Marcar con lápiz</p> <p>Stiftmarkierung</p> <p>Marcar com lápis</p> <p>Segno a matita</p> <p>Potloodmerkteken</p> <p>Marquage au crayon</p>
	<p><b>Loosen Fastener</b></p> <p>Aflojar elemento de fijación</p> <p>Befestigungsteil lösen</p> <p>Desapertar fixador</p> <p>Allentare il fissaggio</p> <p>Bevestiging losdraaien</p> <p>Desserrez les fixations</p>		<p><b>Drill Hole</b></p> <p>Perforar</p> <p>Bohrloch</p> <p>Fazer furo</p> <p>Praticare un foro</p> <p>Gat boren</p> <p>Percez un trou</p>
	<p><b>Phillips Screwdriver</b></p> <p>Destornillador Phillips</p> <p>Kreuzschlitzschraubendreher</p> <p>Chave de fendas Phillips</p> <p>Cacciavite a stella</p> <p>Kruiskopschroevendraaier</p> <p>Tournevis à pointe cruciforme</p>		<p><b>Adjust</b></p> <p>Ajustar</p> <p>Einstellen</p> <p>Ajustar</p> <p>Regolare</p> <p>Afstellen</p> <p>Ajuster</p>
	<p><b>Open-Ended Wrench</b></p> <p>Llave de boca</p> <p>Gabelschlüssel</p> <p>Chave de bocas</p> <p>Chiave a punte aperte</p> <p>Steeksleutel</p> <p>Clé à fourche</p>		<p><b>Remove</b></p> <p>Quitar</p> <p>Entfernen</p> <p>Remover</p> <p>Rimuovere</p> <p>Verwijderen</p> <p>Retirez</p>
	<p><b>By Hand</b></p> <p>A mano</p> <p>Von Hand</p> <p>Com a mão</p> <p>A mano</p> <p>Met de hand</p> <p>À la main</p>		<p><b>Optional</b></p> <p>Opcional</p> <p>Optional</p> <p>Opcional</p> <p>Opzionale</p> <p>Optie</p> <p>En option</p>
	<p><b>Hex-Head Wrench</b></p> <p>Llave de cabeza hexagonal</p> <p>Sechskantschlüssel</p> <p>Chave de cabeça sextavada</p> <p>Chiave esagonale</p> <p>Zeskantsleutel</p> <p>Clé à tête hexagonale</p>		<p><b>Security Wrench</b></p> <p>Llave de seguridad</p> <p>Sicherheitsschlüssel</p> <p>Chave de segurança</p> <p>Chiave di sicurezza</p> <p>Veiligheidssleutel</p> <p>Clé de sécurité</p>

### TOOLS REQUIRED FOR INSTALLATION

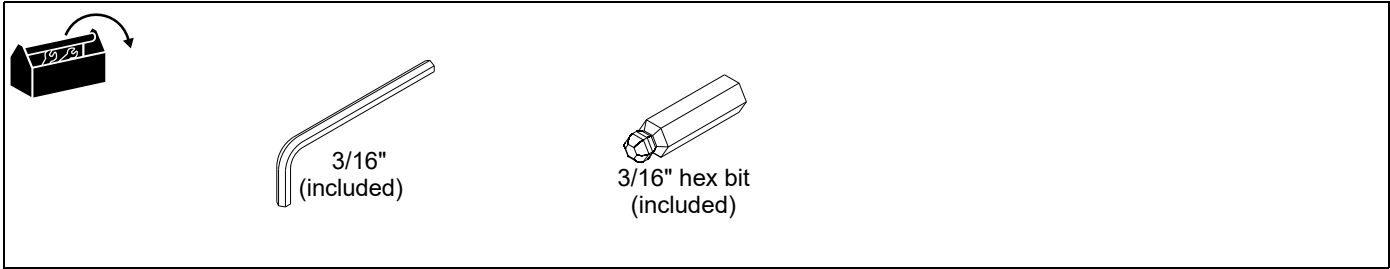

### PARTS

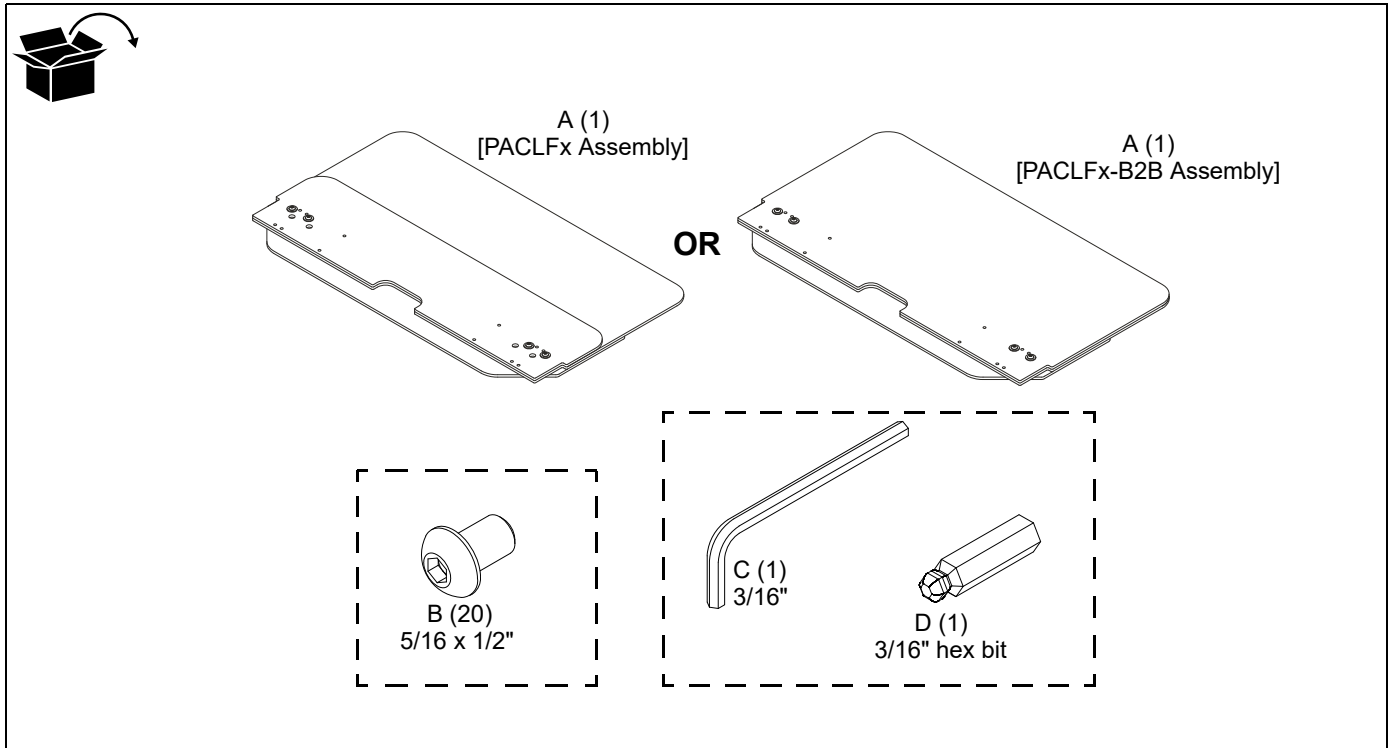

### DISASSEMBLY OF SHIPPED PARTS

1. Remove the fasteners holding the base pieces together. (See Figure 1)

**IMPORTANT !** : Save the washers, and discard the spacers and screws.

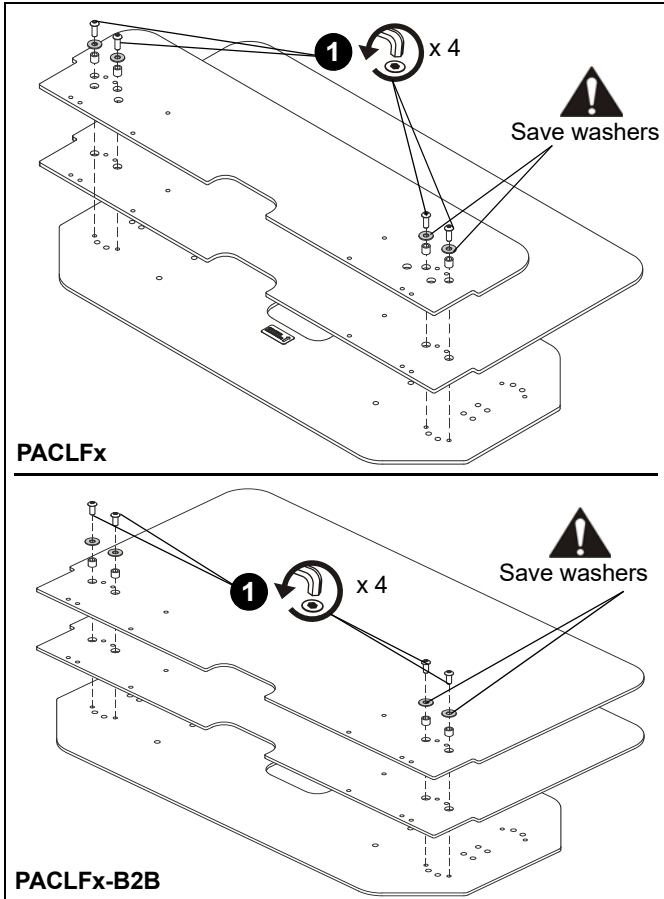

Figure 1

### ASSEMBLY OF PACLFx / PACLFx-B2B

**IMPORTANT !** : When assembling the base, the fasteners are placed in different holes depending upon whether you are using the PACLFx / PACLFx-B2B for a 48" - 40" kiosk or a 55" - 49" kiosk. (See Figure 4) and (See Figure 5)

1. Place rectangular pieces of base on floor, lining up opening area on each piece. (See Figure 2) and (See Figure 3)
2. Lower remaining section of base onto two rectangular sections, lining up screw holes and opening as shown. (See Figure 2) and (See Figure 3)
3. Insert sixteen 5/16 x 1/2" button head screws (B) into highlighted holes and tighten.

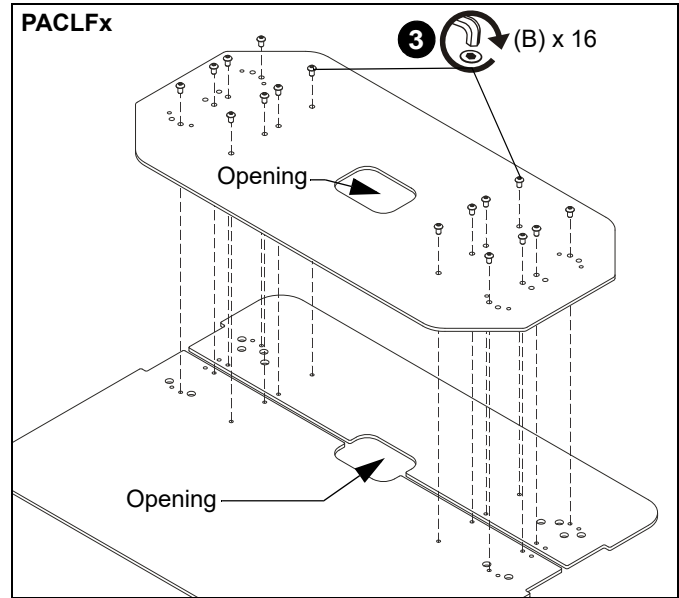

Figure 2

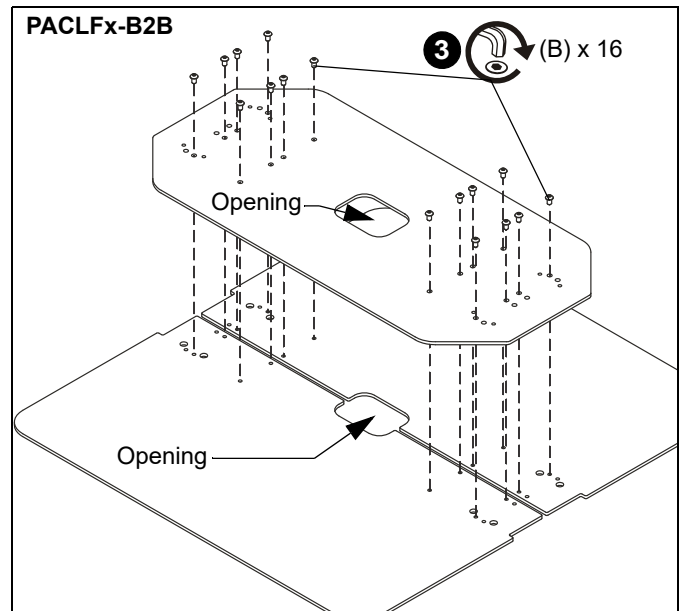

Figure 3

**IMPORTANT ! :** (See Figure 4) for 48" - 40" kiosks, and (See Figure 5) for 55" - 49" kiosks.

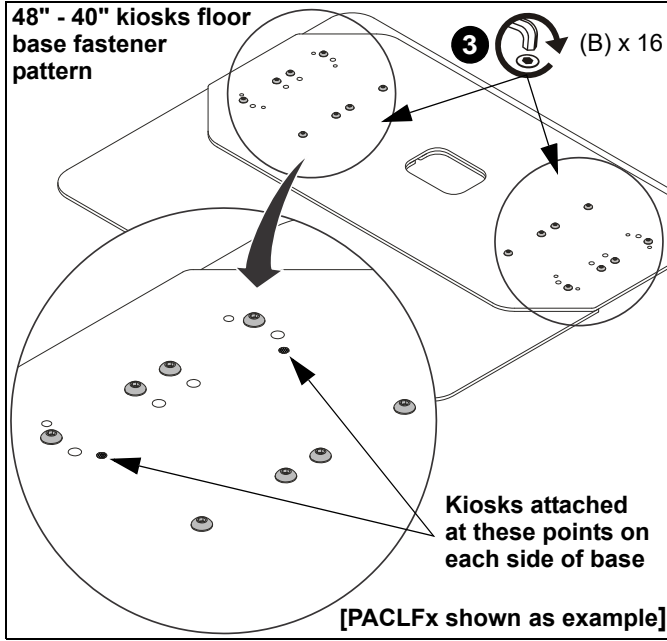

Figure 4

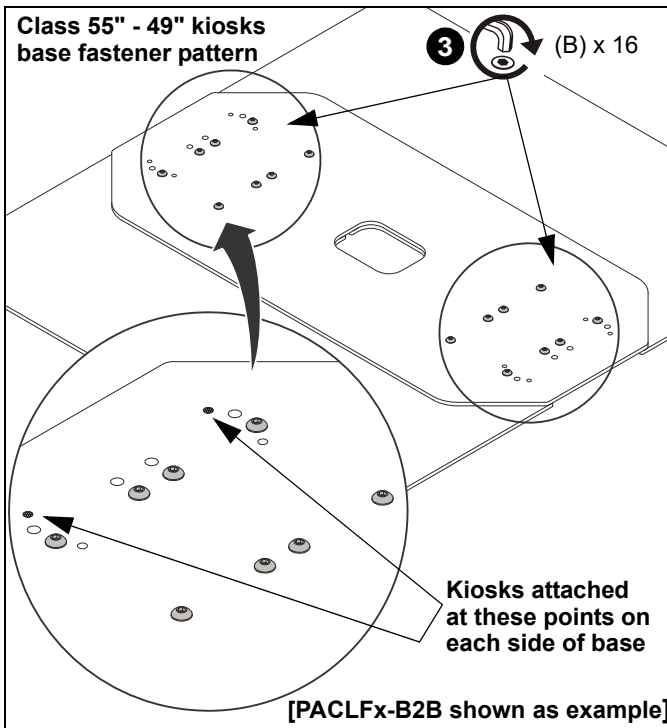

Figure 5

### Attaching Kiosk to Free-Standing Base

1. Place kiosk onto base, lining up mounting holes on kiosk and base. (See Figure 4) and (See Figure 5)

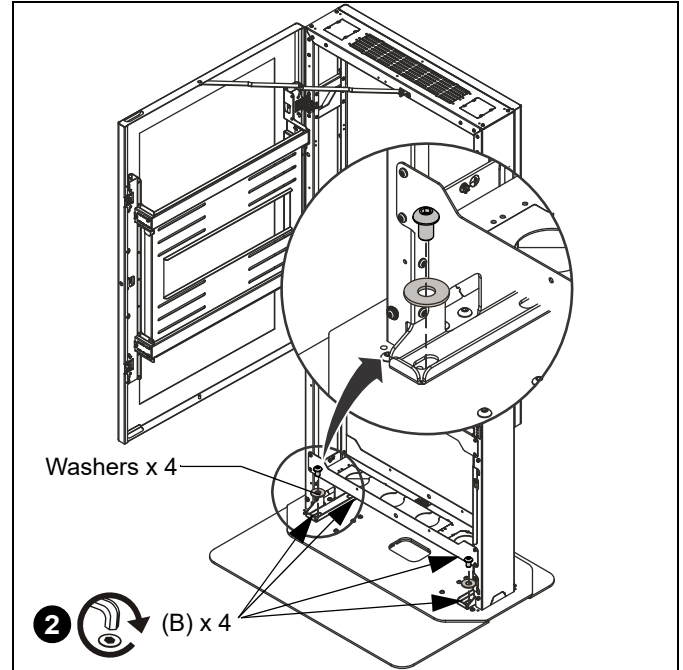

Figure 6

2. Fasten kiosk to base using four 5/16 x 1/2" button head screws (B) and washers removed in Step 1 of **Disassembly of Shipped Parts** section. (See Figure 6)



A brand of  **legrand**

8800-003195 Rev00  
 ©2020 Legrand | AV  
[www.legrandav.com](http://www.legrandav.com)  
 05/2020

<b>USA/International</b>	<p><b>A</b> 6436 City West Parkway, Eden Prairie, MN 55344  <b>P</b> 800.582.6480 / 952.225.6000  <b>F</b> 877.894.6918 / 952.894.6918</p>
<b>Europe</b>	<p><b>A</b> Franklinstraat 14, 6003 DK Weert, Netherlands  <b>P</b> +31 (0) 495 580 852  <b>F</b> +31 (0) 495 580 845</p>
<b>Asia Pacific</b>	<p><b>A</b> Office No. 918 on 9/F, Shatin Galleria          18-24 Shan Mei Street          Fotan, Shatin, Hong Kong  <b>P</b> 852 2145 4099  <b>F</b> 852 2145 4477</p>

