

---

# INSTALLATION INSTRUCTIONS

---

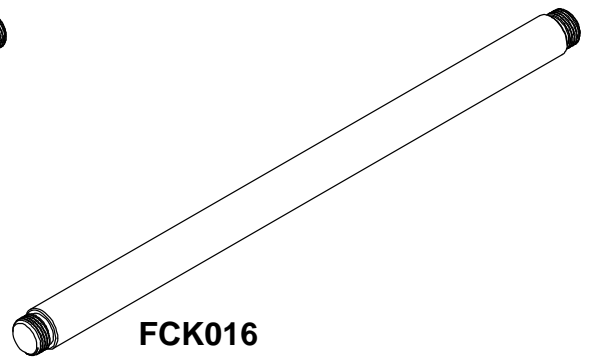
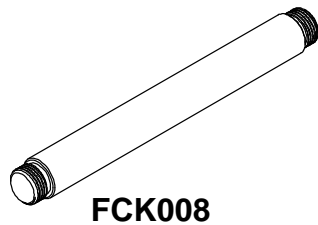
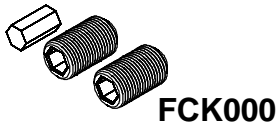

---

**Mount Connector**

---

## DISCLAIMER

Milestone AV Technologies and its affiliated corporations and subsidiaries (collectively "Milestone"), intend to make this manual accurate and complete. However, Milestone makes no claim that the information contained herein covers all details, conditions or variations, nor does it provide for every possible contingency in connection with the installation or use of this product. The information contained in this document is subject to change without notice or obligation of any kind. Milestone makes no representation of warranty, expressed or implied, regarding the information contained herein. Milestone assumes no responsibility for accuracy, completeness or sufficiency of the information contained in this document.

Chief® is a registered trademark of Milestone AV Technologies. All rights reserved.

## IMPORTANT WARNINGS AND CAUTIONS!

 **WARNING:** A WARNING alerts you to the possibility of serious injury or death if you do not follow the instructions.

 **CAUTION:** A CAUTION alerts you to the possibility of damage or destruction of equipment if you do not follow the corresponding instructions.

 **WARNING:** Failure to read, thoroughly understand, and follow all instructions can result in serious personal injury, damage to equipment, or voiding of factory warranty! It is the installer's responsibility to make sure all components are properly assembled and installed using the instructions provided.



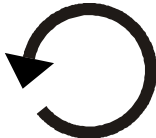

 **WARNING:** Failure to provide adequate structural strength for this component can result in serious personal injury or damage to equipment! It is the installer's responsibility to make sure the structure to which this component is attached can support five times the combined weight of all equipment. Reinforce the structure as required before installing the component.

 **WARNING:** Exceeding the weight capacity can result in serious personal injury or damage to equipment! It is the installer's responsibility to make sure the combined weight of all components located on wall mounts and accessories attached to the wall mounts, does not exceed the weight capacity specified for the wall mount.

## LEGEND

|   |                              |  |                              |
|---|------------------------------|--|------------------------------|
|  | <b>Tighten Fastener</b>      |  | <b>Loosen Fastener</b>       |
|   | Apretar elemento de fijación |  | Aflojar elemento de fijación |
|   | Befestigungsteil festziehen  |  | Befestigungsteil lösen       |
|   | Apertar fixador              |  | Desapertar fixador           |
|   | Serrare il fissaggio         |  | Allentare il fissaggio       |
|   | Bevestiging vastdraaien      |  | Bevestiging losdraaien       |
|   | Serrez les fixations         |  | Desserrez les fixations      |

## TOOLS and PARTS REQUIRED FOR INSTALLATION

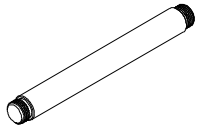
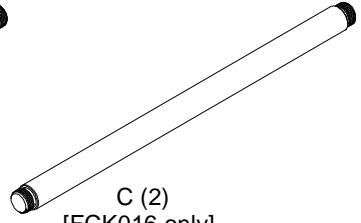
|  |  |  |   |
|--|--|--|---|
| <br><br>1/2" | <br><br>A (1 set)<br>[FCK000 only] | <br>B (2)<br>[FCK008 only] | <br>C (2)<br>[FCK016 only] |
|--|--|--|---|

### INSTALLATION

1. Remove end caps from wall mount rails. (See Figure 1)

4. Install accessories following installation instructions included with accessories.

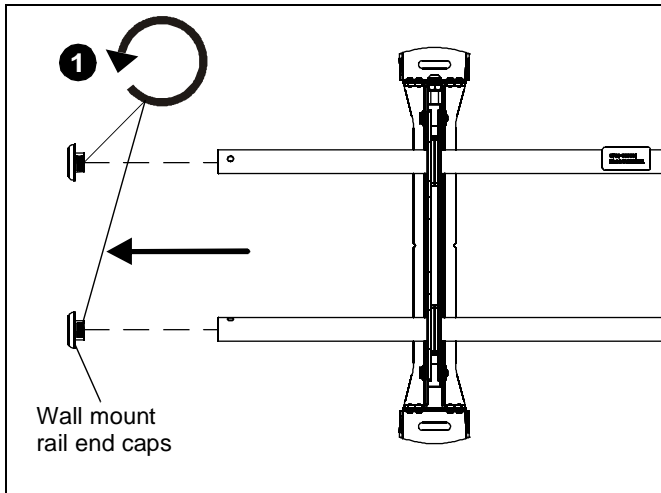

Figure 1

2. Attach FCK000, FCK008 or FCK016 (A, B or C) to the wall mount rails and tighten. (See Figure 2)

**NOTE:** When attaching the FCK000, use tool included with kit to tighten the FCK000 to the wall mount rails.

3. Attach wall mount to wall (if not already done) following installation instructions included with the wall mount.

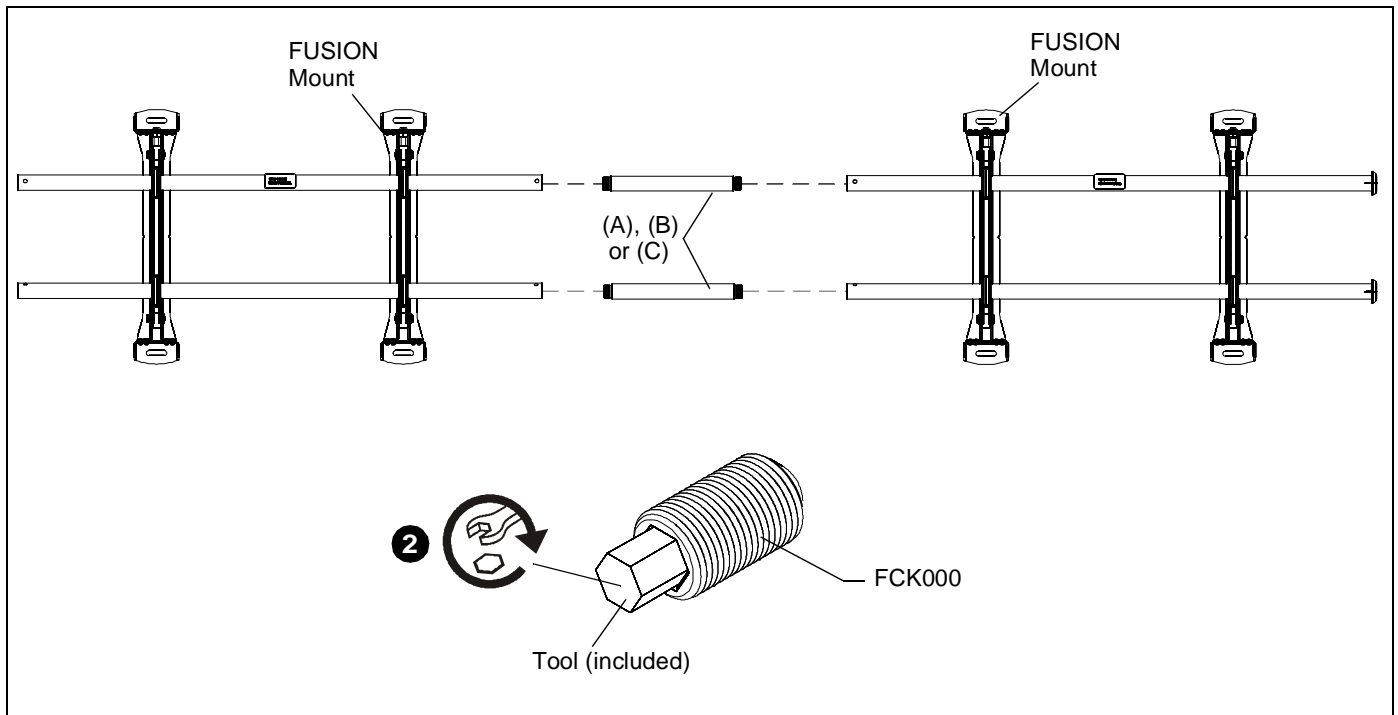

Figure 2



Our Mounts. **Your Vision.**

Chief Manufacturing, a products division  
of Milestone AV Technologies

8805-002005 Rev00  
©2009 Milestone AV Technologies, a  
Duchossois Group Company  
[www.chiefmfg.com](http://www.chiefmfg.com)  
12/09

**USA/International**

**A** 8401 Eagle Creek Parkway, Savage, MN 55378  
**P** 800.582.6480 / 952.894.6280  
**F** 877.894.6918 / 952.894.6918

**Europe**

**A** Fellenoord 130 5611 ZB EINDHOVEN, The Netherlands  
**P** +31 (0)40 2668620  
**F** +31 (0)40 2668615

**Asia Pacific**

**A** Office No. 1 on 12/F, Shatin Galleria  
18-24 Shan Mei Street  
Fotan, Shatin, Hong Kong  
**P** 852 2145 4099  
**F** 852 2145 4477

