

User's Manual (detailed)
Operating Guide

020-001057-02

LW502/LWU502/LX602



CHRISTIE®

LW502/LWU502/LX602

User's Manual (detailed) Operating Guide

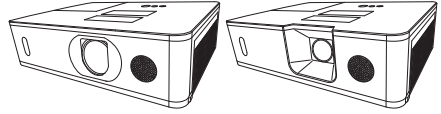

Thank you for purchasing this projector.

⚠ WARNING ▶ Before using this projector, read all the manuals for this projector. Read **Safety Guide** first. After reading the manuals, store them in a safe place for future reference.

About this manual

Various symbols are used in this manual. The meanings of these symbols are described below.

⚠ WARNING This symbol indicates information that, if ignored, could possibly result in personal injury or even death due to incorrect handling.

⚠ CAUTION This symbol indicates information that, if ignored, could possibly result in personal injury or physical damage due to incorrect handling.

NOTICE This entry notices of fear of causing trouble.



Refer to the pages written following this symbol.

- NOTE** • The information in this manual is subject to change without notice.
- The illustrations in this manual are for illustrative purposes. They may differ from your projector.
 - The manufacturer assumes no responsibility for any errors that may appear in this manual.
 - The reproduction, transfer or copy of all or any part of this document is not permitted without express written consent.

Trademark acknowledgment

- VESA and DDC are trademarks of the Video Electronics Standard Association.
 - HDMI™, the HDMI logo, and High-Definition Multimedia Interface are trademarks or registered trademarks of HDMI Licensing LLC in the United States and other countries.
 - Blu-ray Disc™ and Blu-ray™ are trademarks of Blu-ray Disc Association.
 - DICOM® is the registered trademark of the National Electrical Manufacturers Association for its standards publications relating to digital communications of medical information.
 - HDBaseT™ and the HDBaseT Alliance logo are trademarks of the HDBaseT Alliance.
- All other trademarks are the properties of their respective owners.

Contents



Introduction	3	AUDIO menu	75
Features	3	MENU PREFERENCES	76
Checking the contents of package	3	OPTION menu	82
Part names	4	NETWORK menu	95
Projector, Control panel, Ports, Remote control		SECURITY menu	96
Setting up	8	Maintenance	103
Arrangement	9	Replacing the lamp	103
Connecting with your devices	12	Cleaning and replacing the air filter ..	105
Fastening the cables	22	Replacing the internal clock battery ..	107
Fastening the adapter cover	23	Other care	108
Attaching the terminal cover	24	Troubleshooting	109
Using the security bar and slot	25	Related messages	109
Connecting power supply	26	Regarding the indicator lamps	112
Remote control	27	Resetting all settings	116
Installing the batteries	27	Phenomena that may be easy to be mistaken for machine defects ..	117
Changing the frequency of remote control signal ..	28	Specifications	124
About the remote control signal	29		
Power on/off	30		
Turning on the power	30		
Turning off the power	31		
Operating	32		
Adjusting the volume	32		
Temporarily muting the sound	32		
Selecting an input signal	33		
Selecting an aspect ratio	34		
Adjusting the projector's elevator	35		
Adjusting the zoom and focus	35		
Adjusting the lens shift	36		
Using the automatic adjustment feature ..	37		
Correcting the distortion	38		
Using the EDGE BLENDING features ..	41		
Using the magnify feature	45		
Temporarily freezing the screen	46		
Temporarily blanking the screen	46		
PbyP (Picture by Picture) / PIP (Picture in Picture)	47		
Using the menu function	51		
Indication in OSD, Containing items of each menu			
EASY MENU	54		
IMAGE SETTINGS menu	56		
SIZE AND POSITION menu	60		
INPUT menu	63		
SETUP menu	68		

Introduction

Features

The projector provides you with the broad use by the following features.

- ✓ The **HDMI™/HDBaseT™** ports can support various image equipment which have digital interface to get clearer pictures on a screen.
- ✓ The multiple I/O ports is believed to support any business scene.
- ✓ HDCR and eClarity features are original image stabilizer for a clearer image.
- ✓ A DICOM® (“Digital Imaging and Communication in Medicine”) provides simulation mode. This mode simulates the DICOM standard, which is a standard applicable to digital communications in medicine.
- ✓ The built-in 16W speaker delivers sufficient sound volume in a large space like a classroom without external speakers.
- ✓ Equipped with HDCR LiteLoc which maintains visibility by automatic image correction in accordance with lamp deterioration.

Checking the contents of package

See the **Contents of package** section in the **Setup Guide** which is a book. Your projector should come with the items shown there. Consult your dealer immediately if any items are missing.

⚠ WARNING ► Keep small parts away from children and pets. Take care not to put in the mouth. If swallowed, consult a physician immediately for emergency treatment.

NOTE • Keep the original packing materials for future shipment. Use the original packing materials when moving the projector. Use special caution for the lens.

Part names

Projector

- (1) Lamp cover (📖 103)
The lamp unit is inside.
- (2) Speaker (📖 32, 75)
- (3) Filter cover (📖 105)
The air filter and intake vent are inside.
- (4) Elevator feet (x2) (📖 35)
- (5) Elevator buttons (x2)
- (6) Remote sensor (📖 29, 89)
- (7) Lens cover
- (8) Intake vents
- (9) Control panel (📖 5)
- (10) **AC** (AC inlet) (📖 26)
- (11) Exhaust vents
- (12) Ports (📖 6)
- (13) Security bar (📖 25)
- (14) Security slot (📖 25)
- (15) Battery cover (📖 107)

LWU502

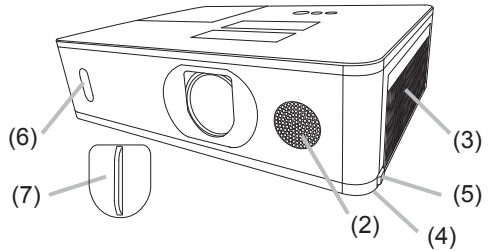

LW502/LX602

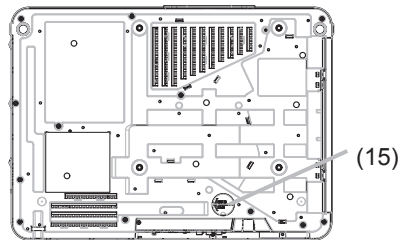
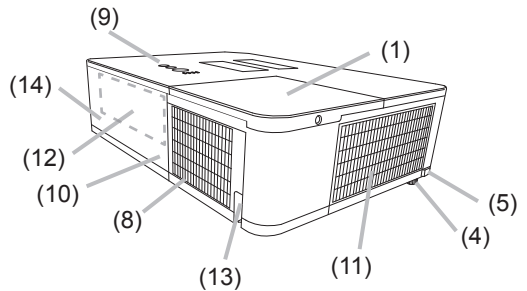
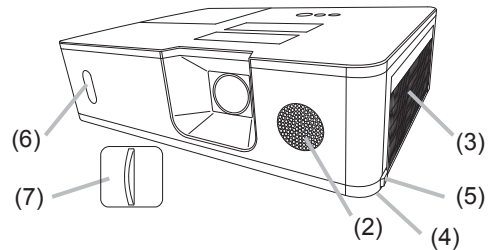

Part names (continued)

⚠ WARNING ▶ Do not open or remove any portion of the projector, unless the manuals direct it.

- ▶ Do not subject the projector to unstable conditions.
- ▶ Do not apply a shock or pressure to this projector. Remove all the attachments including the power cord and cables, from the projector when carrying the projector.
- ▶ Do not look into the lens and the openings on the projector while the lamp is on as the projection ray may cause a trouble on your eyes.
- ▶ Keep any object away from concentrated projection light beam. Blocking the beam can cause high temperatures to occur and may result in smoke or fire.

⚠ CAUTION ▶ Do not touch the lamp cover and the exhaust vents during use or just after use due to excessive heat.

- ▶ Do not attach anything onto the lens except the lens cover of this projector because it could damage the lens, such as melting the lens.



Control panel

- (1) **STANDBY/ON** button (📖 30)
- (2) **INPUT** button (📖 33, 51)
- (3) **MENU** button (📖 51)
- (4) **SECURITY** indicator (📖 102)
- (5) **LAMP** indicator (📖 112 ~ 115)
- (6) **TEMP** indicator (📖 112 ~ 115)
- (7) **POWER** indicator (📖 30, 112 ~ 115)

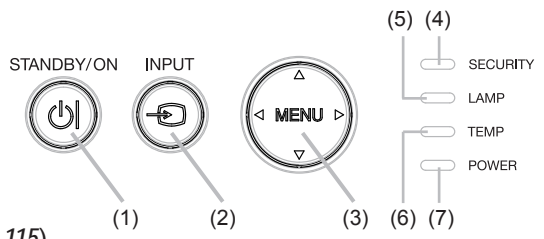

(continued on next page)

Introduction

Part names (continued)

Ports (📖 12-21)

- | | |
|-----------------------------|-------------------------------------|
| (1) COMPUTER IN port | (9) AUDIO IN1 port |
| (2) HDBaseT port * | (10) AUDIO IN2 (L, R) ports |
| (3) LAN port | (11) AUDIO OUT port |
| (4) WIRELESS port | (12) MONITOR OUT port |
| (5) HDMI 1 port | (13) REMOTE CONTROL IN port |
| (6) HDMI 2 port | (14) REMOTE CONTROL OUT port |
| (7) HDMI OUT port | (15) CONTROL port |
| (8) VIDEO port | |

* LW502/LWU502 only

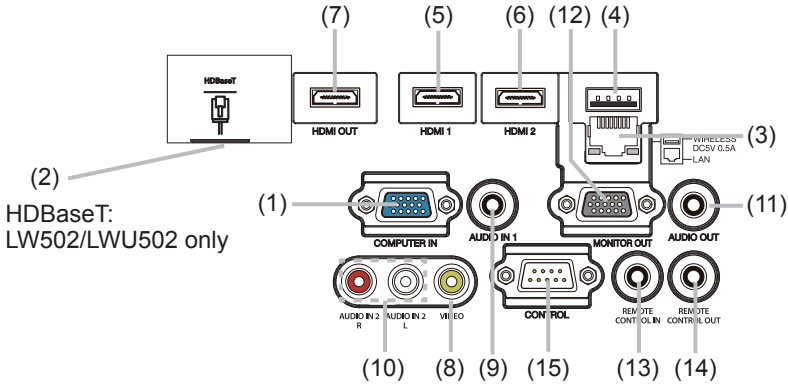

Part names (continued)

Remote control

- (1) **INPUT** button (📖33)
- (2) **MY BUTTON-1** button (📖84)
- (3) **MY BUTTON-2** button (📖84)
- (4) **STANDBY/ON** button (📖30)
- (5) **ASPECT** button (📖34)
- (6) **PbyP** button (📖47)
- (7) **AUTO** button (📖37)
- (8) **FREEZE** button (📖46)
- (9) **MAGNIFY ON** button (📖45)
- (10) **FOCUS +** button *
- (11) **ZOOM +** button *
- (12) **VOLUME +** button (📖32)
- (13) **MAGNIFY OFF** button (📖45)
- (14) **FOCUS -** button *
- (15) **ZOOM -** button *
- (16) **VOLUME -** button (📖32)
- (17) **PAGE UP** button *
- (18) **GEOMETRY** button (📖38)
- (19) **PICTURE** button
- (20) **MUTE** button (📖32)
- (21) **PAGE DOWN** button *
- (22) **INTERACTIVE** button *
- (23) **NETWORK** button
- (24) **BLANK** button (📖46)
- (25) **ESC** button (📖28)
- (26) **MENU** button (📖51)
- (27) **ENTER** button (📖51)
- (28) **OSD MSG** button (📖73)
- (29) **RESET** button (📖51)
- (30) **▲/▼/◀/▶** cursor buttons (📖51)
- (31) Battery cover (📖27)

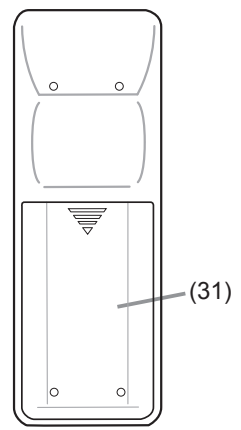
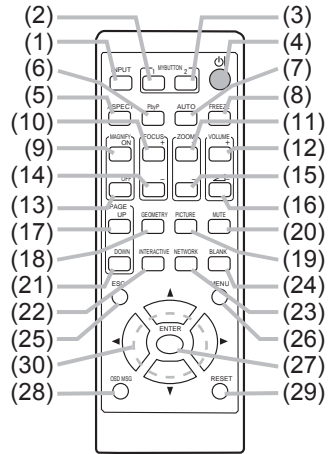

Back of the remote control

NOTE • Any button marked with * is not supported on this projector (📖111).
 • Some keys are unavailable when OSD MESSAGE is set to HIDE (📖73).

Setting up

Setting up

Install the projector according to the environment and manner the projector is used in.

For the case of installation in a special state such as ceiling mount, the specified mounting accessories and service may be required. Before installing the projector, consult your dealer about your installation.

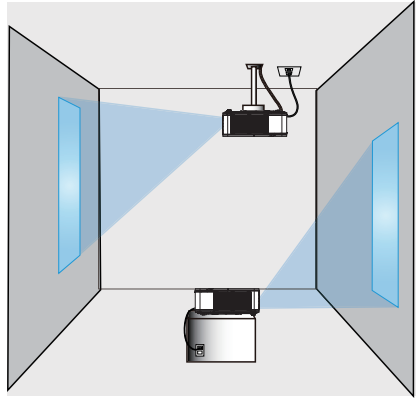

Secure a clearance of 50cm or greater between the exhaust vents and walls, and a clearance of 30cm or greater between the intake vents and walls. Assume that there is enough clearance in the front, back, and top of the projector in the figure below.

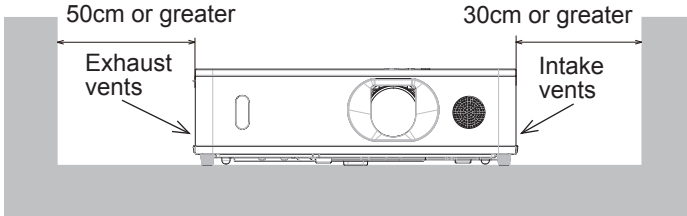

Secure a clearance of 30cm or greater between the intake vents and walls. Assume that there is enough clearance in the front, sides, and top of the projector in the figure below.

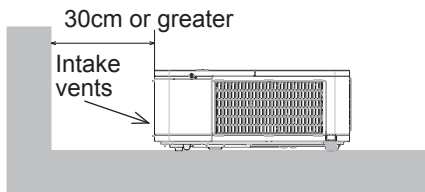

Arrangement

Refer to tables **T-1** to **T-3** at the back of **Setup Guide** as well as the following to determine the screen size and projection distance. The values shown in the table are calculated for a full size screen.

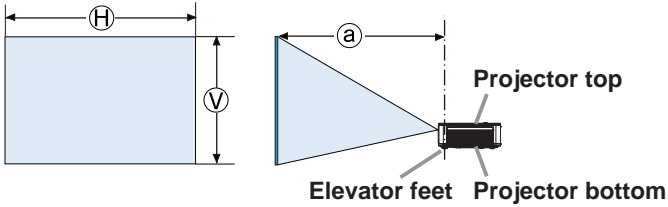

- Ⓜ × Ⓥ : Screen size
- ⓐ : Projection distance

(continued on next page)

Arrangement (continued)

⚠ WARNING ▶ Install the projector where you can access the power outlet easily. If an abnormality should occur, unplug the projector immediately. Otherwise it could cause a fire or electric shock.

▶ Do not subject the projector to unstable conditions. If the projector falls or topples over, it could result in injury or damage to the projector and the surrounding things. Using a damaged projector could result in a fire and an electric shock.

- Do not place the projector in unstable places, such as an inclined surface, places subject to vibration, on top of a wobbly table or cart, or a surface that is smaller than the projector.
- Do not put the projector on its side, front or rear position.
- Do not attach nor place anything on the projector unless otherwise specified in the manual.
- Do not use any mounting accessories except the accessories specified by the manufacturer. Read and keep the manuals of the accessories used.
- For special installation such as ceiling mounting, consult your dealer beforehand.
- Remove all the attachments including the power cord and cables, from the projector when carrying the projector.

▶ Do not install the projector near thermally conductive or flammable things. Such things when heated by the projector could result in a fire and burns.

- Do not place the projector on a metal stand.

▶ Do not place the projector where any oils, such as cooking or machine oil, are used. Oil may harm the projector, resulting in malfunction, or falling from the mounted position. Do not use adhesive such as threadlocker, lubricant and so on.

▶ Do not place the projector in a place where it may get wet. Getting the projector wet or inserting liquid into the projector could cause a fire and an electric shock, and damage the projector.

- Do not place the projector near water, such as in a bathroom, kitchen, or poolside.
- Do not place the projector outdoors or by the window.
- Do not place anything containing liquid near the projector.

▶ Do not block the intake vents and exhaust vents of the projector. If the intake vents and exhaust vents of the projector are blocked, the accumulated inside heat may cause fire.

(continued on next page)

Arrangement (continued)

⚠ CAUTION ▶ Place the projector in a cool place with sufficient ventilation. The projector may shutdown automatically or may malfunction if its internal temperature is too high.

Using a damaged projector could result in a fire and an electric shock.

- Do not place the projector in direct sunlight or near hot objects such as heaters.
- Do not place the projector where the air from an air conditioner or similar unit directly blows on it.
- Do not place the projector on carpet, cushions or bedding.
- Do not stop up, block nor cover the projector's vent holes. Do not place anything around the projector that could be sucked in or stuck to the projector's intake vents.
- Do not place the projector at places that are exposed to magnetic fields, doing so can cause the cooling fans inside the projector to malfunction.

▶ Avoid placing the projector in smoky, humid or dusty place. Placing the projector in such places could cause a fire, an electric shock and malfunction of the projector.

- Do not place the projector near humidifiers. Especially for an ultrasonic humidifier, chlorine and minerals contained in tap water are atomized and could be deposited in the projector causing image degradation or other problems.
- Do not place the projector in a smoking area, kitchen, passageway or by the window.

NOTICE • Position the projector to prevent light from directly hitting the projector's remote sensor.

- Do not place the projector in a place where radio interference may be caused.
- Set the ALTITUDE of the SERVICE item in the OPTION menu correctly. If the projector is used at an altitude of about 1600 m or higher, set ALTITUDE of the SERVICE item in the OPTION menu to HIGH (📖88). Otherwise, set it to NORMAL.
- Keep heat-sensitive things away from the projector. Otherwise, they may be damaged by the heat from the projector.

NOTE • When the temperature inside the projector rises high, it may cause the high rotation of the fan for cooling temporarily.

Connecting with your devices

Before connecting the projector to a device, consult the manual of the device to confirm that the device is suitable for connecting with this projector and prepare the required accessories, such as a cable in accord with the signal of the device. Consult your dealer when the required accessory did not come with the projector or the accessory is damaged.

After making sure that the projector and the devices are turned off, perform the connection, according to the following instructions. Refer to the figures in subsequent pages.

Before connecting the projector to a network system, read **Network Guide** too.

⚠ WARNING ▶ Use only the appropriate accessories. Otherwise it could cause a fire or damage the projector and devices.

- Use only the accessories specified or recommended by the projector's manufacturer. It may be regulated under some standard.
- Neither disassemble nor modify the projector and the accessories.
- Do not use the damaged accessory. Be careful not to damage the accessories. Route a cable so that it is neither stepped on nor pinched out.

⚠ CAUTION ▶ For a cable with a core at only one end, connect the end with the core to the projector. That may be required by EMI regulations.

NOTE • Do not turn on or off the projector while connected to a device in operation, unless directed in the manual of the device. Otherwise it may cause malfunction in the device or projector.

- The function of some input ports can be selected according to your requirements. Check the reference page indicated beside each port in the following illustration (📖 13 ~ 21).
- Be careful not to mistakenly connect a connector to a wrong port. Otherwise it may cause malfunction in the device or projector.
 - When connecting a connector to a port, make sure that the shape of the connector fits the port.
 - Tighten the screws to connect a connector equipped with screws to a port.
 - Use the cables with straight plugs, not L-shaped ones, as the input ports of the projector are recessed.

About Plug-and-Play capability

- Plug-and-Play is a system composed of a computer, its operating system and peripheral equipment (such as display devices). This projector is VESA DDC 2B compatible. Plug-and-Play can be used by connecting this projector to a computer that is VESA DDC (display data channel) compatible.
 - Take advantage of this feature by connecting a computer cable to the **COMPUTER IN** port (DDC 2B compatible). Plug-and-Play may not work properly if any other type of connection is attempted.
 - Use the standard drivers in your computer as this projector is a Plug-and-Play monitor.

(continued on next page)

Connecting with your devices (continued)

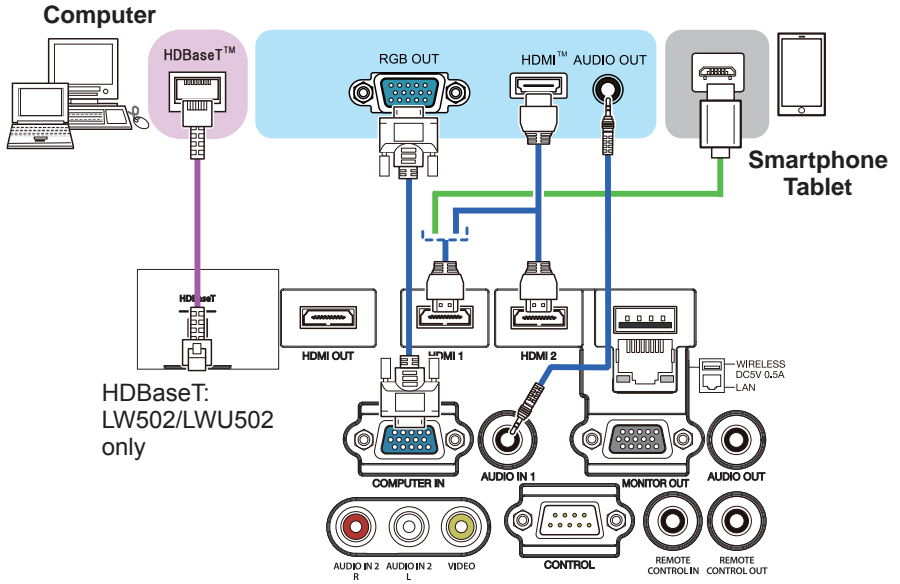

(continued on next page)

Connecting with your devices (continued)

- NOTE** • Before connecting the projector to a computer, consult the computer's manual and check the compatibility of the signal level, the synchronization methods and the display resolution output to the projector.
- Some signal may need an adapter to input this projector.
 - Some computers have multiple screen display modes that may include some signals which are not supported by this projector.
 - Although the projector can display signals with a resolution up to UXGA (1600x1200) or up to W-UXGA (1920x1200), the signal is converted to the projector's panel resolution before being displayed. The best display performance is achieved if the resolutions of the input signal and the projector panel are identical.
 - If you connect this projector and a notebook computer, you must output the display to an external monitor, or output simultaneously to the internal display and an external monitor. Consult the computer's manual for the setting.
 - Depending on the input signal, the automatic adjustment function of this projector may take some time and not function correctly.
 - A composite sync signal or sync-on-green signal may confuse the automatic adjustment function of this projector (📖 65).
 - If the automatic adjustment function does not work correctly, you may not see the dialog to set the display resolution. In such a case, use an external display device. You may see the dialog and set an appropriate display resolution.

(continued on next page)

Connecting with your devices (continued)

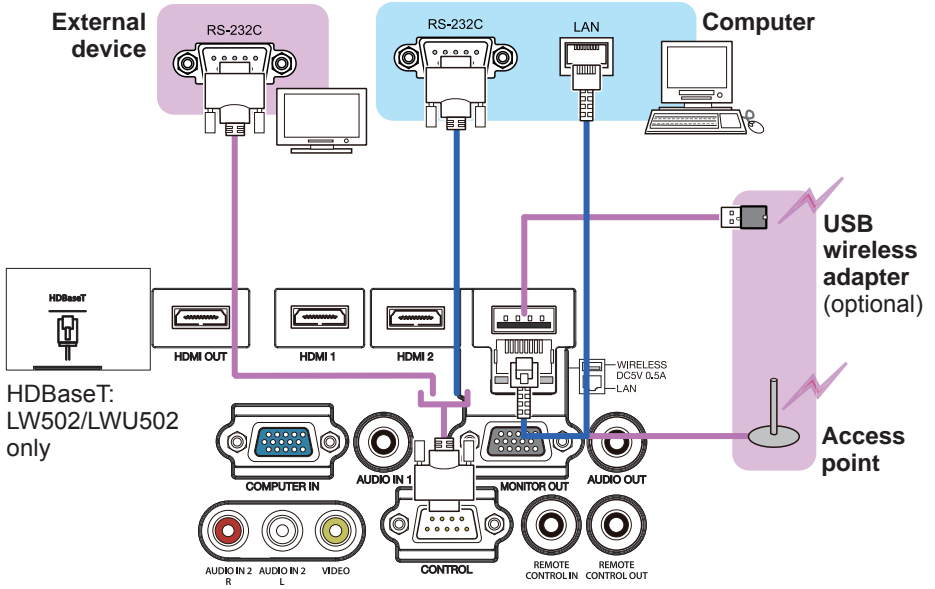

(continued on next page)

Connecting with your devices (continued)

⚠ **WARNING** ▶ Heat may build up in the USB wireless adapter, to avoid possible burns disconnect the projector power cord for 10 minutes before touching the adapter.

▶ When using the USB wireless adapter, use the supplied adapter cover (📖24).

⚠ **CAUTION** ▶ Before connecting the projector to a network system, obtain the consent of the administrator of the network.

▶ Do not connect the **LAN** port to any network that might have the excessive voltage.

▶ The designated USB wireless adapter sold as an option is required to use the wireless network function of this projector. Before connecting the USB wireless adapter, turn off the power of the projector and disconnect the power cord. Do not use any extension cable or device when connecting the adapter to the projector.

▶ To connect both the LAN cable and USB wireless adapter to the projector, use a LAN cable that is flat on the side where the plug's wire is visible. Otherwise, both of them cannot be connected correctly, or the wire may break (malfunction).

(continued on next page)

Connecting with your devices (continued)

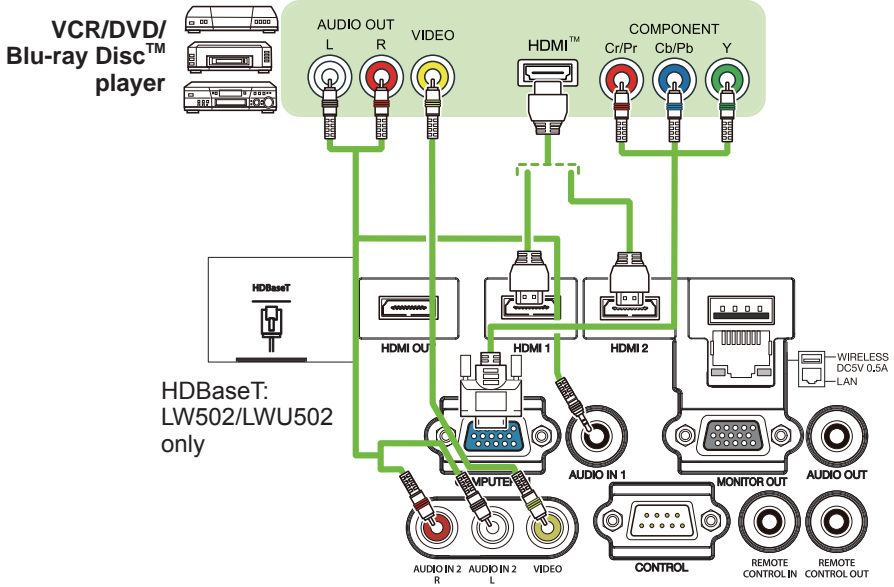

(continued on next page)

Connecting with your devices (continued)**About HDBaseT™ connection**

- HDBaseT is a technology to transmit image, sound, ethernet or serial control signal using a LAN cable.
- Go to the following URL regarding the device of other company that supports HDBaseT and has been confirmed compatible with this projector.

<http://www.christiedigital.com>

LAN or HDBaseT input port can be selected as ethernet signal input by switching in the menu.

- Use LAN cables of up to 100m long. Exceeding this length, the image and sounds are deteriorated, and even experience malfunction on LAN transmission.

NOTE • The **HDMI** ports of this model are compatible with HDCP (High-bandwidth Digital Content Protection) and therefore can display video signals from HDCP compatible DVD players.

- The **HDMI** ports support the following signals:

For Video signals, refer to User's Manual (detailed) Technical.

Audio signal : Format Linear PCM

Sampling frequency 48kHz / 44.1kHz / 32kHz

- This projector can be connected with another equipment that has HDMI™ connector, but with some equipment the projector may not work properly, something like no video.
- Qualified cable is required for HDBaseT connection.
- Use an HDMI™ cable that has the HDMI™ logo.
- Use a Category 2-certified HDMI™ cable to input 1080p@60 signal to the projector.
- When the projector is connected with a device having DVI connector, use a DVI to HDMI™ cable to connect with the HDMI™ input.
- The HDMI™ cables might come off due to the lack of a mechanical lock on the cables and connectors. Fasten the HDMI cables by using the HDMI cable holder and the Cable tie to prevent them from coming off (📖22).

(continued on next page)

Connecting with your devices (continued)

- NOTE** • This projector has HDMI input/output ports and can be connected to multiple devices such as projectors or monitors with HDMI cable.
- The projected image is output when HDMI 1 or HDBaseT is selected.
 - The resolution of the signal input to the projector and signal output from the projector may be restricted by the maximum resolution of the connected device such as projector or monitor.
 - HDMI output operation in normal standby depends on the setting of the menu (🔍74). It is not output during saving standby.
 - When outputting HDMI signal, turn on the output side connected device before inputting image signal to the projector.
 - Up to 7 devices can be connected in series for HDMI output port of this projector.
 - The number of devices that can be connected varies depending on HDCP version, the restriction of the number of devices for HDCP repetition of source device, and the quality of a cable.
 - The projected image from the projector may be interrupted when POWER OFF/ON, input switching, or HDMI cable removal/insertion is executed on the second or subsequent projector or monitor.
 - HDMI output may be interrupted when the projector is turned on/off.

(continued on next page)

Setting up

Connecting with your devices (continued)

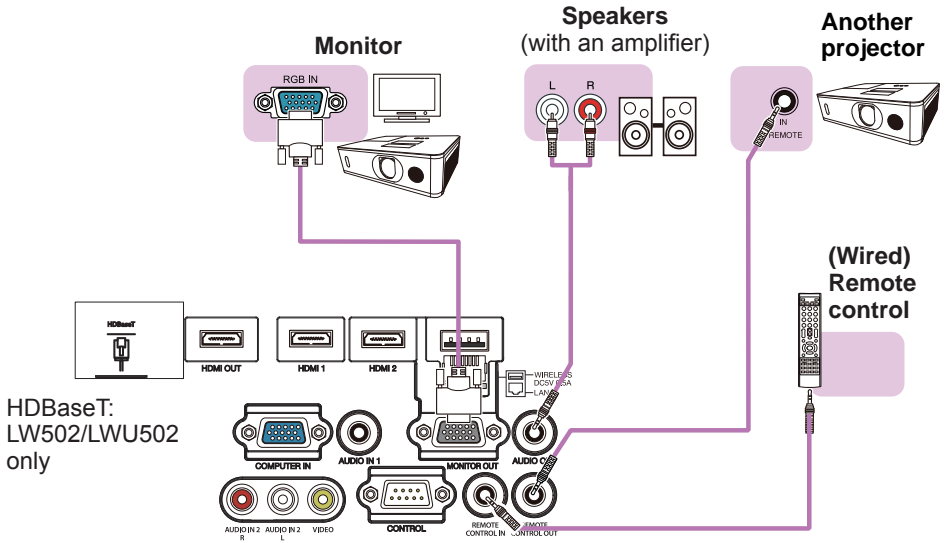

(continued on next page)

Connecting with your devices (continued)

NOTE • To use a wired remote control, connect a wired remote control to the **REMOTE CONTROL IN** port. You can also connect another projector to the **REMOTE CONTROL OUT** port to control it from the wired remote control. You can use this projector as a remote control-relay with the **REMOTE CONTROL IN** and **OUT** ports. To connect the wired remote control or another projector to the **REMOTE CONTROL IN** or **OUT** ports, use audio cables with 3.5 mm diameter stereo mini plugs. This function is useful when a wireless remote signal may not reliably reach the projector.

Setting up

Fastening the cables

Use the supplied cable tie to fasten the cables.

Remove the screw located on the lower side of HDMI connector and use it to attach the HDMI cable holder.

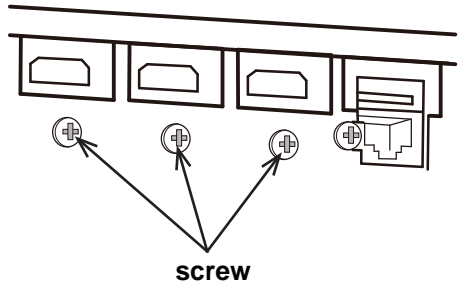
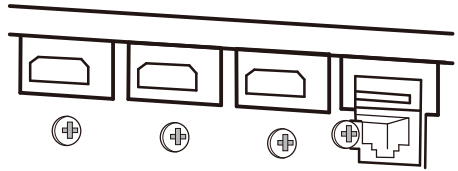

Fasten the HDMI cables by using the HDMI cable holder and the cable tie to prevent them from coming off. Use a cable tie with the size of 2.0 x 4.0mm or smaller.

No cable tie

With cable tie

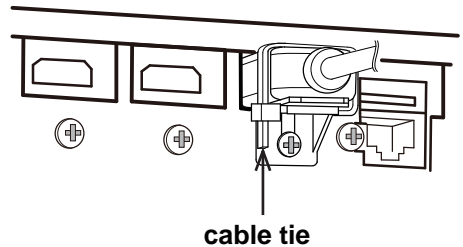
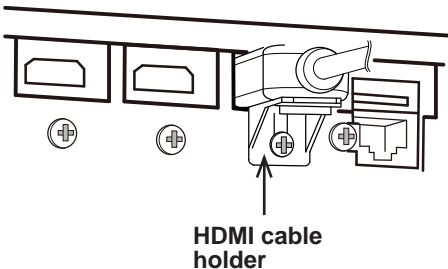

- ⚠ **WARNING** ▶ Do not fasten the cables other than HDMI.
- ⚠ **CAUTION** ▶ To fasten the cable, use a supplied cable tie or plastic tie with the size of 2.0 x 4.0mm or smaller. A metallic tie may cause damage to the cables and tie holder.
- ▶ Do not bind the cables too tightly. The cables or the hole might be damaged.

Fastening the adapter cover

When using the USB wireless adapter, use the supplied adapter cover for theft prevention.

USB wireless adapter: USB-WL-11N-NS

Temperature range: 0 ~ 40°C (operating)

1. Loosen the screw on the bottom left of the **WIRELESS** port.

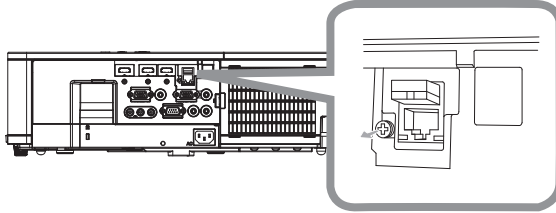

2. Insert the tab of the cover into the hole at the upper right of the **WIRELESS** port in the direction of the arrow.

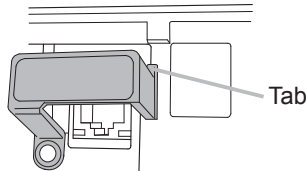

3. Align the screw holes on the projector and the cover. Then insert the screw removed from the projector into the hole and tighten the screw.

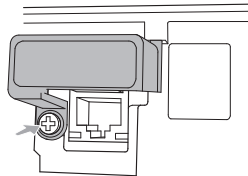

⚠ WARNING ► Keep small parts away from children and pets. Take care not to put in the mouth.

► Heat may build up in the USB wireless adapter, to avoid possible burns disconnect the projector power cord for 10 minutes before touching the adapter.

Attaching the terminal cover (LW502/LWU502 only)

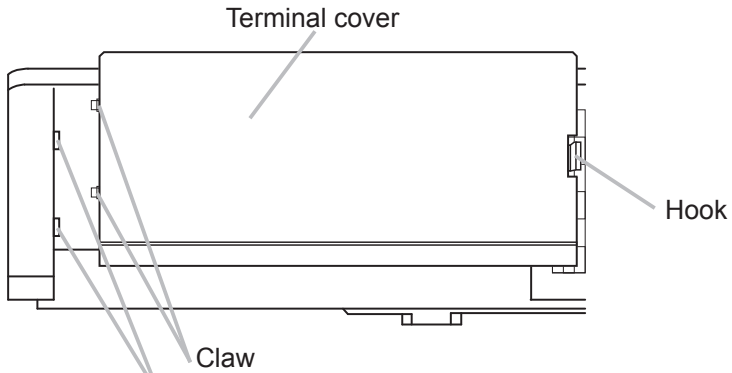

Insert the two claws of the terminal cover into the hole of the case and confirm hook is fitting into the case.

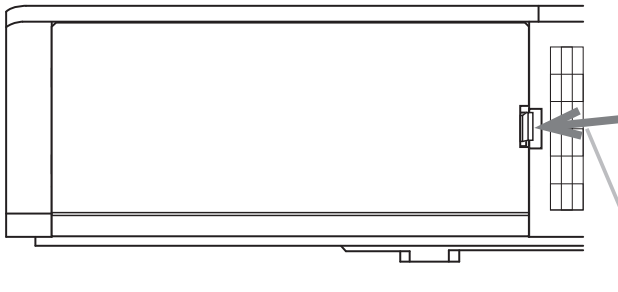

When detaching the terminal cover, push the hook in the direction of the arrow and pull it forward.

Using the security bar and slot

A commercially available anti-theft chain or wire can be attached to the security bar on the projector. Refer to the figure to choose an anti-theft chain or wire.

This projector has the security slot for the Kensington lock. For details, see the manual of the security tool.

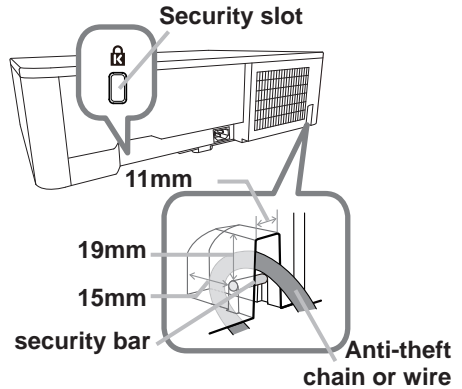

⚠ WARNING ▶ Do not use the security slot to prevent the projector from falling down, as it is not designed for it.

⚠ CAUTION ▶ Do not place anti-theft chain or wire near the exhaust vents. It may become too hot.

NOTE • The security bar and slot is not comprehensive theft prevention measures. It is intended to be used as supplemental theft prevention measure.

When using the optional suspension bracket, fix the bundled hook metal and screws securely, and attach the drop-prevention chain.

• Pass the drop-prevention chain through the hole of the optional suspension bracket and hook metal, and fix it securely with a quick link.

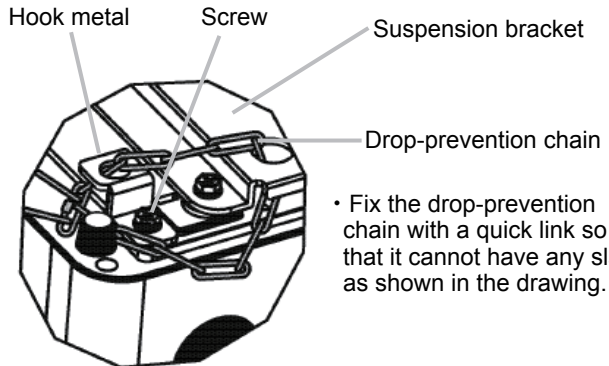

• Fix the drop-prevention chain with a quick link so that it cannot have any slack as shown in the drawing.

Setting up

Connecting power supply

1. Put the connector of the power cord into the **AC** (AC inlet) of the projector.
2. Firmly plug the power cord's plug into the outlet. In a couple of seconds after the power supply connection, the **POWER** indicator lights up in steady orange.

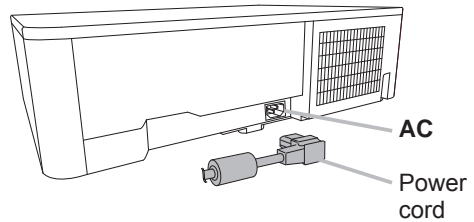

When the DIRECT POWER ON function activated, the connection of the power supply makes the projector turn on.

⚠ WARNING ► Use extra caution when connecting the power cord, as incorrect or faulty connections may result in fire and/or electrical shock.

- Do not touch the power cord with a wet hand.
- Only use the power cord that came with the projector. If it is damaged, consult your dealer to get a new one. Never modify the power cord.
- Only plug the power cord into an outlet whose voltage is matched to the power cord. The power outlet should be close to the projector and easily accessible. Remove the power cord for complete separation.
- Do not distribute the power supply to multiple devices. Doing so may overload the outlet and connectors, loosen the connection, or result in fire, electric shock or other accidents.
- Connect the ground terminal for the AC inlet of this unit to the ground terminal of the building using an appropriate power cord (bundled).

NOTICE • This projector is also designed for IT power systems with a phase-to-phase voltage of 220 to 240 V.

Remote control

Installing the batteries

Insert the batteries into the remote control before using it. If the remote control starts to malfunction, replace the batteries. If not using the remote control for long period, remove the batteries from the remote control and store them in a safe place.

1. Remove the battery cover.
2. Align and insert the two AA batteries according to their plus and minus terminals as indicated in the remote control. (Use the appropriate AA carbon-zinc or alkaline batteries (non-rechargeable) according to laws and regulations. Batteries are not included.)
3. Put the battery cover back to the former state.

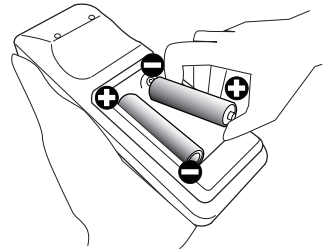

⚠ WARNING ▶ Always handle the batteries with care and use them only as directed. Improper use may result in battery explosion, cracking or leakage, which could result in fire, injury and/or pollution of the surrounding environment.

- Use only the batteries specified. Do not use batteries of different types at the same time. Do not mix a new battery with used one.
- Make sure the plus and minus terminals are correctly aligned when loading a battery.
- Keep a battery away from children and pets.
- Do not recharge, short circuit, solder or disassemble a battery.
- Do not place a battery in a fire or water. Keep batteries in a dark, cool and dry place.
- If you observe battery leakage, wipe out the leakage and then replace a battery. If the leakage adheres to your body or clothes, rinse well with water immediately.
- Obey the local laws on disposing the battery.

Changing the frequency of remote control signal

The accessory remote control has the two choices on signal frequency Mode 1:NORMAL and Mode 2:HIGH. If the remote control does not function properly, attempt to change the signal frequency.

To set the Mode, press the combination of two buttons listed below simultaneously for about three seconds.

- (1) Set to Mode 1:NORMAL
VOLUME - and **RESET** buttons
- (2) Set to Mode 2:HIGH
MAGNIFY OFF and **ESC** buttons

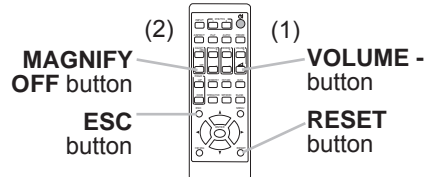

REMOTE_FREQ. in the SERVICE item of the OPTION menu (📖 89) of the projector to be controlled should be set to the same mode as the remote control.

About the remote control signal

The remote control works with the projector's remote sensor.

This projector has a remote sensor on the front.

The sensors can sense signals within the following range:

60 degrees (30 degrees to the left and right of the sensor)
within about 3 meters.

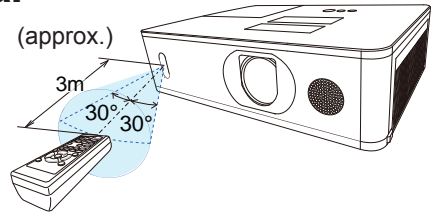

NOTE • You can deactivate one of the sensors using the REMOTE RECEIV. item in the SERVICE menu of the OPTION menu (📖 89).

- The remote control signal reflected in the screen may be available. If it is difficult to send the signal to the sensor directly, try to make the signal reflect.
- The remote control uses infrared light to send signals to the projector (Class 1 LED). Use the remote control in an area free from obstacles that could block the remote control's signal to the projector.
- The remote control may not work correctly if strong light (such as direct sun light) or light from an extremely close range (such as from an inverter fluorescent lamp) shines on the remote sensor of the projector. Adjust the position of projector avoiding those lights.

Power on/off

Turning on the power

1. Make sure that the power cord is firmly and correctly connected to the projector and the outlet.
2. Make sure that the **POWER** indicator is lighted in steady orange (📖 112). Then remove the lens cover.
3. Press the **STANDBY/ON** button on the projector or the remote control.
The projection lamp lights up and the **POWER** indicator begins blinking in green. When the power is completely on, the indicator stops blinking and lights in steady green (📖 112).

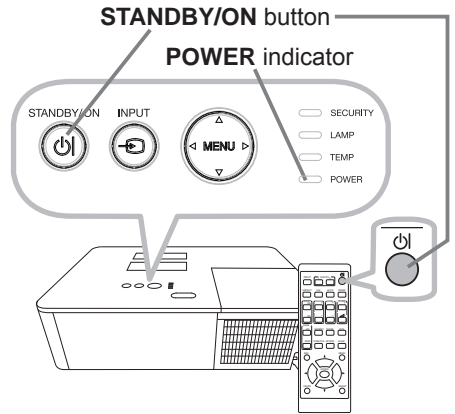

To display the picture, select an input signal according to the section **Selecting an input signal** (📖 33).

The INITIAL SETTING Menu is displayed by factory default upon startup. Once the INITIAL SETTING Menu is set, it does not appear until **FACTORY RESET** (📖 94) is executed. If you want to change the settings, refer to the **LANGUAGE** (📖 76) and **ALTITUDE** (📖 88) menu.

(1) **LANGUAGE**: Use the ▲/▼/◀/▶ buttons to select the desired language and press the **ENTER** button of the remote control or the **INPUT** button of the projector to execute.

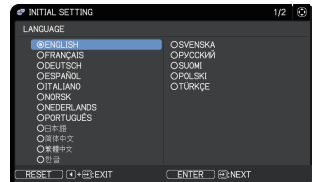

(2) **ALTITUDE**: Use the ▲/▼ buttons to select **NORMAL** for altitude below 1600 m (5250 feet), otherwise select **HIGH** and press the **ENTER** button of the remote control or the **INPUT** button of the projector to execute.

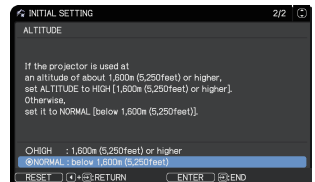

(continued on next page)

Turning off the power

1. Press the **STANDBY/ON** button on the projector or the remote control.
 - The message “Power off?” appears on the screen for about five seconds.
2. Press the **STANDBY/ON** button again while the message appears.
 - The projector lamp goes off, and the **POWER** indicator begins blinking in orange. The **POWER** indicator stops blinking and lights in a steady orange when the lamp cooling is completed (📖 112).
3. Attach the lens cover, after the **POWER** indicator turns to steady orange.

Do not turn the projector on for about 10 minutes or more after turning it off. Do not turn the projector off shortly after turning it on. Such operations might cause the lamp to malfunction or shorten the lifetime of some parts including the lamp.

⚠ WARNING ▶ A strong light is emitted when the projector’s power is on. Do not look into the lens of the projector or look inside of the projector through any of the projector’s openings as the projection ray may cause a trouble on your eyes.

▶ Keep objects away from concentrated projection light beam. Blocking the beam can cause high temperatures to occur and may result in smoke or fire.

▶ Do not touch around the lamp cover and the exhaust vents during use or just after use, as it is too hot.

NOTE • Turn the power on/off in the right order. Power on the projector prior to the connected devices.

- This projector can automatically turn on/off. Refer to the **DIRECT POWER ON** (📖 83) and **AUTO POWER OFF** (📖 83) items of the **OPTION** menu.

Operating

Adjusting the volume

Use the **VOLUME + / -** buttons to adjust the volume. A dialog appears on the screen to help you in adjusting the volume. If you do nothing, the dialog automatically disappears after a few seconds.



- NOTE**
- When \times is selected for current picture input port, the volume adjustment is disabled. See AUDIO SOURCE item of AUDIO menu (875).
 - If the projector is in the standby mode, the volume is adjustable when both of the following conditions are true:
 - An option other than \times is selected for AUDIO OUT in the STANDBY OUTPUT item of the SETUP menu (874).
 - NORMAL is selected in the STANDBY MODE item of the SETUP menu (872).

Temporarily muting the sound

Press **MUTE** button on the remote control. A dialog appears on the screen indicating that you have muted the sound. To restore the sound, press the **MUTE**, **VOLUME +** or **VOLUME -** button. Even if you do not do anything, the dialog automatically disappears after a few seconds.



- NOTE**
- When \times is selected for current picture input port, the sound is always muted.
 - See AUDIO SOURCE item of AUDIO menu (875).
 - Closed Caption C.C. is automatically activated when sound is muted and an input signal containing Closed Caption C.C. is received. This function is available only when the signal is NTSC for **VIDEO** or **COMPUTER IN**, and when AUTO is selected for DISPLAY in the Closed Caption C.C. menu under the MENU PREFERENCES (881).

Selecting an input signal

Press **INPUT** button on the projector or the remote control. Select a desirable input referring to the displayed input list.

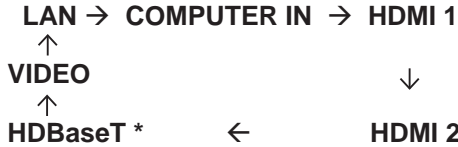

* LW502/LWU502 only

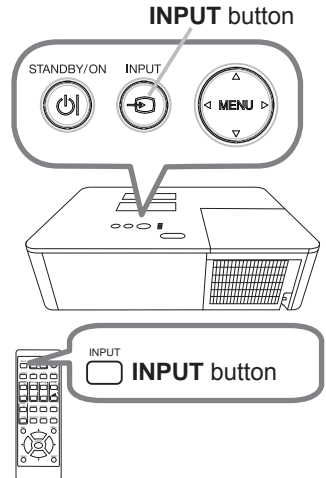

- NOTE**
- If you have set SKIP to some ports from SOURCE SKIP in the OPTION menu, the input from the ports cannot be selected (📖 82).
 - While ON is selected for AUTO SEARCH item in the OPTION menu, the projector keeps checking the ports in the above order repeatedly until an input signal is detected (📖 82).

Selecting an aspect ratio

Press the **ASPECT** button on the remote control. Each time you press the button, the projector switches the mode for aspect ratio in sequence.



○ **For a computer signal**

NORMAL → 4:3 → 16:9 → 16:10 → ZOOM → NATIVE *



* LW502/LWU502 only

○ **For HDMI™ and HDBaseT™ signals**

NORMAL → 4:3 → 16:9 → 16:10 → 14:9 → ZOOM → NATIVE *



* LW502/LWU502 only

○ **For a video signal**

4:3 → 16:9 → 16:10 * → 14:9 → ZOOM → NATIVE *



* LW502/LWU502 only

○ **For an input signal from the LAN port, or if there is no signal**

LW502/LWU502: 16:10 (fixed)

LX602: 4:3 (fixed)

NOTE • The **ASPECT** button does not work when no proper signal is input.
• **NORMAL** mode keeps the original aspect ratio setting.

Adjusting the projector's elevator

When the place to put the projector is slightly uneven to the left or right, use the elevator feet to place the projector horizontally. Using the feet can also tilt the projector in order to project at a suitable angle to the screen, elevating the front side of the projector within 11 degrees.

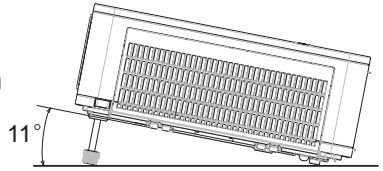

This projector has 2 elevator feet and 2 elevator buttons. An elevator foot is adjustable while pushing the elevator button on the same side as it.

1. Holding the projector, push the elevator buttons to loose the elevator feet.
2. Position the front side of the projector to the desired height.
3. Release the elevator buttons in order to lock the elevator feet.
4. After making sure that the elevator feet are locked, put the projector down gently.
5. If necessary, the elevator feet can be manually twisted to make more precise adjustments. Hold the projector when twisting the feet.

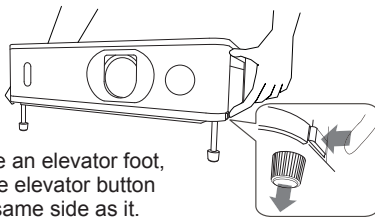

To loose an elevator foot, push the elevator button on the same side as it.

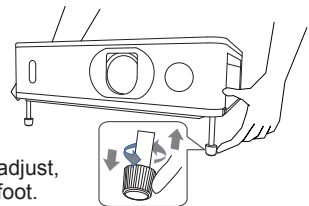

To finely adjust, twist the foot.

⚠ CAUTION ▶ Do not handle the elevator buttons without holding the projector, since the projector may drop down.
 ▶ Do not tilt the projector other than elevating its front within 11 degrees using the adjuster feet. A tilt of the projector exceeding the restriction could cause malfunction or shortening the lifetime of consumables, or the projector itself.

Adjusting the zoom and focus

1. Use the **ZOOM** ring to adjust the screen size.
2. Use the **FOCUS** ring to focus the picture.

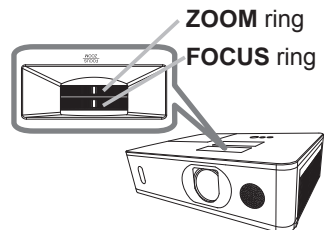

Adjusting the lens shift

1. Turn the **VERTICAL** adjuster fully counter clockwise. Then turn it clockwise and adjust the vertical lens position upward.
2. Turn the **HORIZONTAL** adjuster clockwise or counter clockwise to adjust the horizontal lens position.

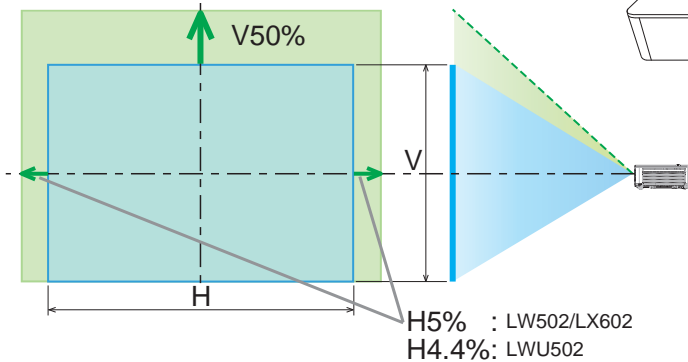
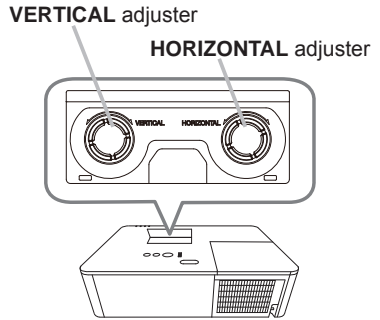

⚠ CAUTION ▶ Operate the lens adjusters gently as the lens may malfunction when subjected to shocks. It may need more strength to turn the adjusters near the adjustment limits. Be careful not to apply too much strength. If the lens adjuster is turned excessively, it runs idle by a clutch mechanism inside the adjuster. Although it makes a clicking sound, it is not a malfunction. When the lens adjuster runs idle, the lens shift cannot be performed further. Turn the lens adjuster to the opposite direction to adjust the lens shift. When the lens adjuster is turned too quickly, it may make a clicking sound by a clutch mechanism. In that case, turn it slowly to adjust the lens shift.

- When adjusting the lens shift to the maximal oblique direction, the periphery of the projected screen may be dark or a shadow may be cast.
- When adjusting the lens shift vertically, perform it by moving the projected screen upward. If adjusting the lens shift by moving the projected screen downward, the projected screen may be adjusted slightly low.

NOTE • When the lens adjuster runs idle with a clicking sound and it still makes a sound by a clutch mechanism even if it is turned to the opposite direction, turn the lens adjuster while pressing it downward to perform the lens shift.

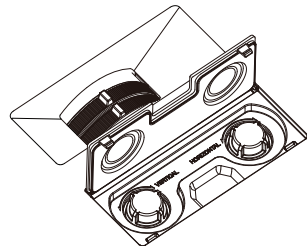

Using the automatic adjustment feature

Press **AUTO** button on the remote control.
Pressing this button performs the following.



AUTO
AUTO button

○ **For a computer signal**

The vertical position, the horizontal position and the horizontal phase are automatically adjusted.

Make sure that the application window is set to its maximum size prior to attempting to use this feature. A dark picture may still be incorrectly adjusted. Use a bright picture when adjusting.

○ **For a video signal**

The video format best suited for the respective input signal is selected automatically. This function is available only when the AUTO is selected for the VIDEO FORMAT item in the INPUT menu (64). The vertical position and horizontal position are automatically set to the default.

○ **For a component video signal**

The vertical position and horizontal position are automatically set to the default. The horizontal phase is automatically adjusted.

- NOTE** • The automatic adjustment operation requires approximately. 10 seconds. Also note that it may not function correctly with some input.
- When this function is performed for a video signal, an extra line may appear outside a picture.
 - When this function is performed for a computer signal, a black frame may be displayed on the edge of the screen, depending on the computer model.
 - The items adjusted by this function may vary when the FINE or DISABLE is selected for the AUTO IMAGE ADJUST item of the SERVICE item in the OPTION menu (88).

Correcting the distortion

To correct the distortion of projected screen, you can select one of three options, **KEYSTONE**, **3D KEYSTONE**, and **WARPING**. First press the **GEOMETRY** button to display the **GEOMETRY CORRECTION** menu, and point at one of the items with the **▲/▼** buttons.

KEYSTONE: Adjusts the vertical and horizontal keystone.

3D KEYSTONE: Adjusts each of the screen corners and sides to correct the distortion.

WARPING: Projects an image on several types of screen.

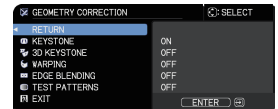
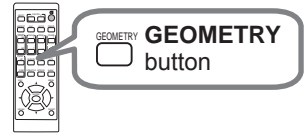

Use **KEYSTONE** / **3D KEYSTONE** / **WARPING** for adjustment. When one is selected, other items are not available.

Complete the following procedure shown below for the item you selected.

NOTE • The menu or dialog automatically disappears after several seconds of inactivity. Press the **GEOMETRY** button again, or point the cursor at **EXIT** in the dialog and press the **▶** or **ENTER** button to end the operation and close the menu or dialog.

○ **KEYSTONE**:

When **KEYSTONE** is pointed at, pressing the **▶** or **ENTER** button displays the **KEYSTONE** dialog.

1. Select the vertical or horizontal keystone (▲/▼) with the **▲/▼** buttons.
2. Use the **◀/▶** buttons to adjust the keystone distortion.



NOTE • When the zoom adjustment is set to the **TELE** (telephoto focus), this function may be excessive. This function should be used when the zoom adjustment is set to the full **WIDE** (wide-angle focus).

- When the horizontal lens shift is not set to the center, this function may not work correctly.
- Point at **RETURN** in the dialog with the **▲/▼** buttons and press **◀** or **ENTER** button to return to the **GEOMETRY CORRECTION** menu.

Correcting the distortion (continued)

○ 3D KEYSTONE:

When 3D KEYSTONE is pointed at, pressing the ► or **ENTER** button displays the 3D KEYSTONE dialog.

This projector is equipped with a test pattern for 3D KEYSTONE. Select TEST PATTERNS with the ▲/▼ buttons, then press the ◀/▶ buttons to switch on and off.

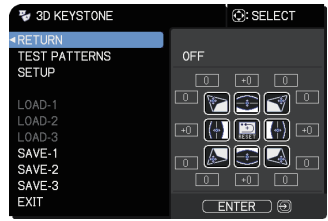

1. Select SETUP with the ▲/▼ buttons and press the ► or **ENTER** button.
2. Select one of the corners or sides to be adjusted with the ▲/▼/◀/▶ buttons and press the **ENTER** or ◻ button.
3. Adjust the selected part as below.
 - To adjust a corner, use the ▲/▼/◀/▶ buttons to adjust the position of the corner.
 - To adjust the upper or lower side, use the ▲/▼ buttons to adjust the distortion of the side.
 - To adjust the left or right side, use the ◀/▶ buttons to adjust the distortion of the side.
 - To adjust another corner or side, press the **ENTER** or ◻ button and follow the procedure from step 2.

(continued on next page)

Correcting the distortion (continued)

4. This projector is equipped with a memory feature for 3D KEYSTONE adjustment. Up to three sets of adjustments can be stored.
 - **SAVE:**

To store the current 3D KEYSTONE adjustment, select one of the "SAVE" options numbered 1 to 3 (number of the memory) with the ▲/▼ buttons and press the ►, **ENTER** or **↵** button.

The current data being stored are lost by saving new data.
 - **LOAD:**

To recall stored adjustments, select one of the "LOAD" options numbered 1 to 3 (number of the memory) with the ▲/▼ buttons and press the ►, **ENTER** or **↵** button.

The current adjusted condition is lost by loading data. If you want to keep the current adjustment, save it before performing a LOAD function.

NOTE • The LOAD functions whose linked memories have no data are skipped.
• There may be some noise and the screen may flicker for a moment when loading data. This is not malfunction.

○ WARPING:

Projection on several types of screen can be performed by WARPING function. This function is operated by using dedicated PC tool, "Warping Tool". PC and projector are required to be connected with LAN cable to use this function.

You can get the PC tool from the following URL.

<http://www.christiedigital.com>

Refer to Application Manual for operations.

Using the EDGE BLENDING features

1. MODE (MANUAL)

OFF: Disables the Blending function.

MANUAL: Allows you to adjust Blending Region or Blending Level by using menu.

- HDCR LiteLoc is not selectable when Blending is set to other than OFF.
- ECO MODE is not selectable when Blending is set to other than OFF.

2. BLENDING LEVEL

Select BLENDING LEVEL with ▲/▼ buttons.

[1-25] can be selected with ◀/▶ buttons.

Adjust the brightness of Blending Region according to the settings.

3. BLENDING REGION

3.1 Specifying Blending Region

Select one of the four sides with ▲/▼/◀/▶ buttons and press **ENTER** or **↶** button. Blending Region can be specified for left and right sides with ◀/▶ buttons and for top and bottom sides with ▲/▼ buttons.

Specify Blending Region for each projector.

Adjust them referring to the guide displayed during the adjustment of Blending Region.

* The minimum value of Blending Region is 200 dots.

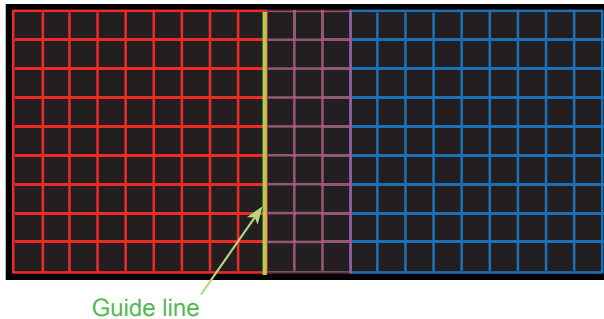

(continued on next page)

4. CROPPING

When inputting the same image to each projector, The cropping function enables projector to cut out a part of input image and display one image on a large screen. The following patterns are supported.

2 x 1



1 x 2



2 x 2



4.1 Displaying Cropping Menu

Select CROPPING with ▲/▼ buttons and press ►, **ENTER** or ↻ button to display Cropping Menu.

4.2 Setting Cropping

Select MODE with ▲/▼ buttons and select ON with ◀/▶ buttons.

The input image is automatically cut out according to the settings of Blending Region.

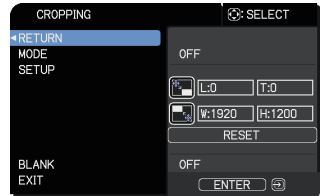

(continued on next page)

4.3 Adjusting Cropping Area

Adjust Cropping Area when cutting out a part of input image.

Select SETUP with ▲/▼ buttons and press ►, the **ENTER** or **↻** button.

* MODE is set to [OFF] temporarily and the guide of Cropping Area is displayed.

Select [LT]/[WH] with ▲/▼ buttons and press the **ENTER** or **↻** button.

Move the guide display with ▲/▼/◀/▶ buttons to select the region of the screen to be cut out.

Press the **ENTER** or **↻** button and then press ◀ button to select SETUP, and MODE switches to ON automatically.

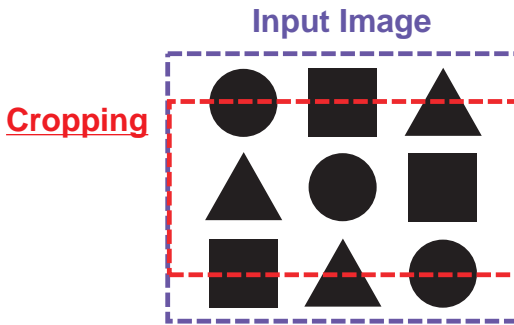

4.4 Adjust Cropping Area of the other projector.

Set Cropping Area of the other projector with the same value as one projector. The input image is automatically cut out according to the settings of Blending Region.

* To keep input image from not being seen while setting up, set BLANK to ON.

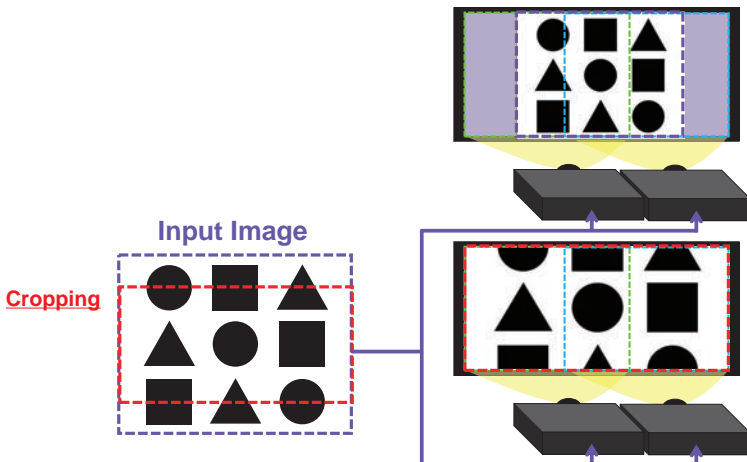

(continued on next page)

5. Dimming Level

Adjusts the brightness of the projectors which are using Blending.
Using the ◀/▶ buttons to adjust the dimming level.

6. WHITE BALANCE

Adjusts the white balance of the whole screen.

6.1 OFFSET

Changes the color intensity on the whole tones.

6.2 GAIN

Mainly affects color intensity on the brighter tones.

NOTE • The positional deviation of the screen may occur after installing the projector over time. Perform the screen adjustment again to correct the positional deviation.

Using the magnify feature

1. Press the **MAGNIFY ON** button on the remote control.

The picture is magnified, and the MAGNIFY dialog appears on the screen. When the **MAGNIFY ON** button is pressed for the first time after the projector is turned on, the picture is zoomed by 1.5 times. On the dialog, triangle marks to show each direction are displayed.

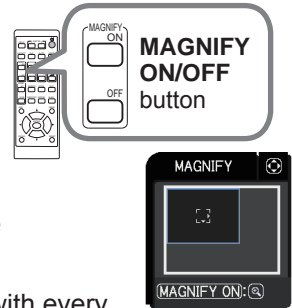

2. The display magnification of the projector switches with every press of the **MAGNIFY ON** button.

- For computer signals, HDMI™ (RGB) signals, HDBaseT™ signals, input signals from the LAN port

1.5 times → 2 times → 3 times → 4 times → 1 time



- For video signals, HDBaseT signals, or HDMI™ signals

1.5 times → 2 times → 1 time



3. While the triangles are displayed on the dialog, use the ▲/▼/◀/▶ cursor buttons to shift the magnifying area.
4. Press the **MAGNIFY OFF** button on the remote control to exit magnification.

NOTE • The MAGNIFY dialog automatically disappears in several seconds with no operation. The dialog appears again if the **MAGNIFY ON** button is pressed when the dialog has automatically disappeared.

- The magnification is automatically disabled when the displaying signal or its display condition is changed.
- While the magnification is active, the keystone distortion condition may vary. It is restored when the magnification is disabled.
- Some horizontal stripes might be visible on the image while magnification is active.
- This function is not available in the following cases:
 - A sync signal in the range not supported is input.
 - There is no input signal.

Temporarily freezing the screen

Press the **FREEZE** button on the remote control. The “FREEZE” indication appears on the screen (however, the indication does not appear when OFF is selected for the OSD MESSAGE item in the SETUP (73)), and the projector goes into the FREEZE mode, which the picture is frozen. To exit the FREEZE mode and restore the screen to normal, press the **FREEZE** button again.



NOTE • The projector automatically exits from the FREEZE mode when some control buttons are pressed.

- If the projector continues projecting a still image for a long time, the LCD panel might possibly be burned in. Do not leave the projector in the FREEZE mode for too long.
- Images might appear degraded when this function is operated, but it is not a malfunction.

Temporarily blanking the screen

Press **BLANK** button on the remote control. The BLANK screen is displayed instead of the screen of input signal. Refer to BLANK item in MENU PREFERENCES (76). To exit from the BLANK screen and return to the input signal screen, press **BLANK** button again.



- The projector automatically exits from the BLANK mode when some control buttons are pressed.

⚠ CAUTION ▶ If you want a blank screen while the projector's lamp is on, use the BLANK function above. Any other action may cause the damage on the projector.

NOTE • The sound is not connected with the BLANK screen function. If necessary, set the volume or mute first.

PbyP (Picture by Picture) / PIP (Picture in Picture)

The PbyP / PIP is a function for displaying two different picture signals on a screen that is separated into main and sub areas for each signal.

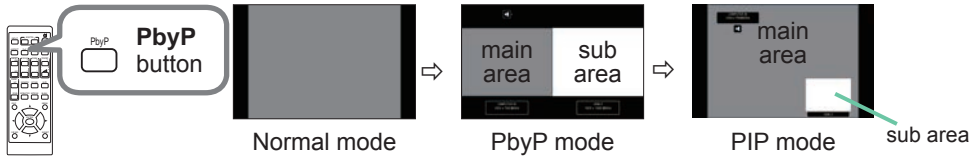

Press the **PbyP** button on the remote control. This activates the PbyP mode. Then, press the **PbyP** button again. The projector goes into PIP mode. The screen displayed before the **PbyP** button was pressed is displayed as the main area. Most of operations are effective for the main area only. Only outputs the audio input signal paired with the picture input signal for the main area. To quit the PIP mode, press the **PbyP** button again.

NOTE • If the **LAN** port is selected when the **PbyP** button is pressed, input from other port is displayed on the main area.

- When in the PbyP / PIP mode, use the **MENU** button on the remote control or ▲/▼ buttons on the control panel to display the OSD menu.
- Some functions that cannot be used when in the PbyP / PIP mode.
- A message is displayed when buttons that cannot be used are pressed (📖111). However, messages are not displayed for some unusable buttons.
- The functions on the OSD menu that cannot be used are displayed in gray and cannot be selected.

(continued on next page)

Operating

PbyP (Picture by Picture) / PIP (Picture in Picture) (continued)

○ **Setting information**

The setting information appears for several seconds when the PbyP / PIP function is started. Displays the input information for each area. A frame around the main area and an audio mark indicating the audio output are also displayed. The information can be redisplayed with the ◀/▶ buttons after it has been erased.

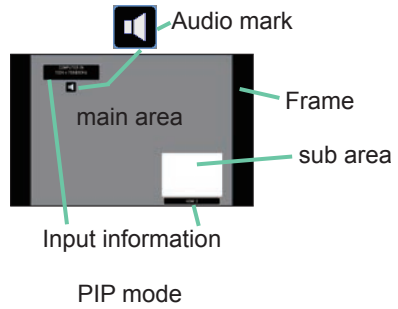
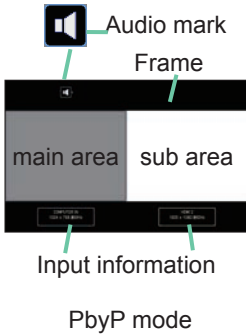

○ **Changing the main area**

The position of the main area can be toggled with the ◀/▶ buttons when the setting information is displayed on the screen. The frame and the audio mark move together with it.

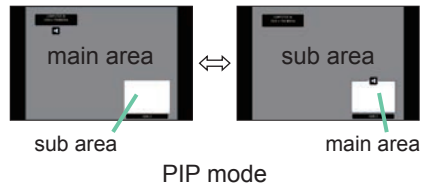
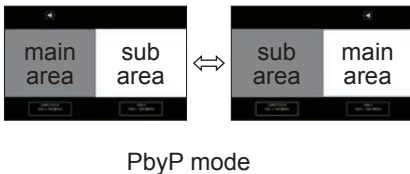

(continued on next page)

PbyP (Picture by Picture) / PIP (Picture in Picture) (continued)

○ Changing the picture input signal

Press any button to select an input port on the remote control or press the **INPUT** button on the control panel. A dialog box to select the input signal for the main area is displayed. Choose a signal using the ▲/▼ buttons. To change the signal in the sub area, switch temporarily across to the main area with the ◀/▶ buttons.

Displaying the same signal on the both areas is not allowed. Refer to the table for details on available input signal combinations. Any combinations marked with "X" cannot be selected.

Sub area \ Main area	COMPUTER IN	LAN	HDMI 1	HDMI 2	HDBaseT *	VIDEO
COMPUTER IN	X	X	O	O	O	X
LAN	X	X	X	X	X	X
HDMI 1	O	X	X	O	X	O
HDMI 2	O	X	O	X	O	O
HDBaseT *	O	X	X	O	X	O
VIDEO	X	X	O	O	O	X

* LW502/LWU502 only

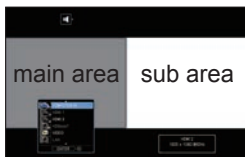

Input signal

PbyP mode



Input signal

sub area

PIP mode

NOTE • The combined input signals marked with an "O" can be selected and displayed in the PbyP / PIP mode even when the port is set to SKIP with the SOURCE SKIP on the OPTION menu (82).

(continued on next page)

Operating

PbyP (Picture by Picture) / PIP (Picture in Picture) (continued)

○ **PbyP / PIP SWAP function**

Press the **MY BUTTON** assigned the PbyP / PIP SWAP (📖84). The position of the area is exchanged without any setting change.

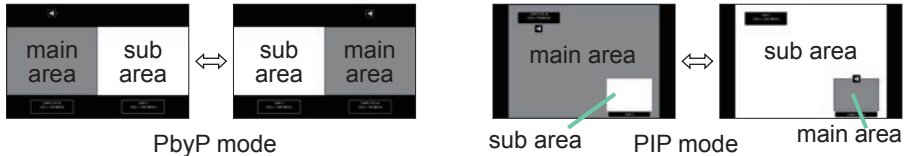

NOTE • For some signals, it may not be displayed correctly in the PbyP / PIP mode, even if it can be displayed properly in the normal mode.
 • PbyP / PIP is unavailable when MANUAL is selected in GEOMETRY CORRECTION > EDGE BLENDING > MODE.

○ **Changing the size of main area in PbyP mode**

Using ▲/▼ buttons on the remote control changes the size of main area in PbyP mode.

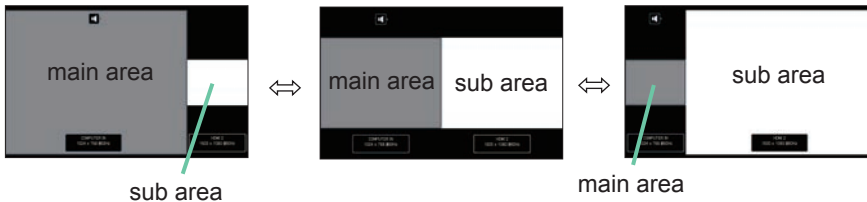

○ **Changing the position of sub area in PIP mode**

1. Select INPUT MENU > PbyP / PIP SETUP > PIP POSITION (📖67).
2. Using ▲/▼ buttons on the remote control changes the position of sub area in PIP mode.

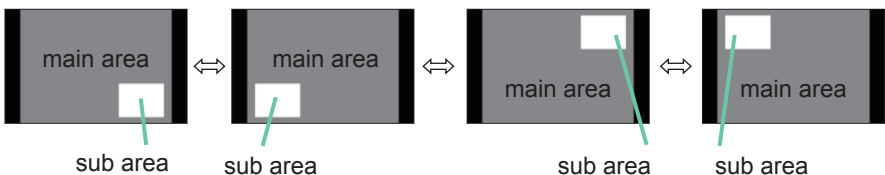

Using the menu function

This projector has the following menus:

IMAGE SETTINGS, SIZE AND POSITION, INPUT, SETUP, AUDIO, MENU PREFERENCES, OPTION, NETWORK, SECURITY and EASY MENU. EASY MENU consists of functions often used, and the other menus are classified into each purpose and brought together as the ADVANCED MENU.

Each menu is operated using the same methods. While the projector is displaying any menu, the **MENU** button on the projector works as the cursor buttons. The basic operations of these menus are as follows.

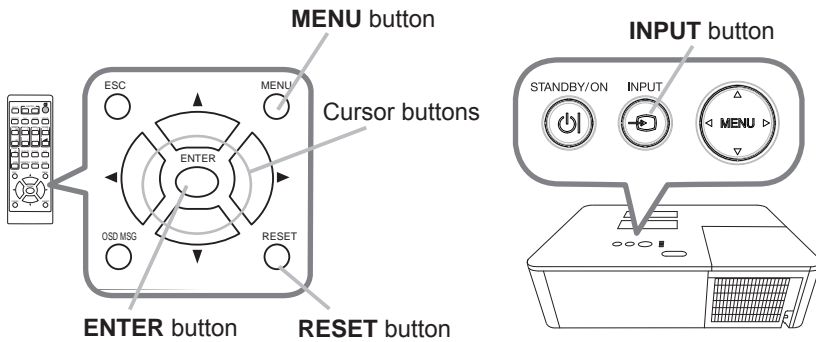

1. To start the MENU, press the **MENU** button. The MENU you last used (EASY or ADVANCED) appears. EASY MENU has priority to appear just after powered on.

2. In the EASY MENU

- (1) Use the ▲/▼ cursor buttons to select an item to operate. To change it to the ADVANCED MENU, select the ADVANCED MENU.
- (2) Use the ◀/▶ cursor buttons to operate the item.

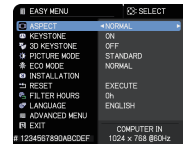

In the ADVANCED MENU

- (1) Use the ▲/▼ cursor buttons to select a menu. To change it to the EASY MENU, select the EASY MENU. The items in the menu appear on the right side.
- (2) Press the ▶ cursor button or **ENTER** button to move the cursor to the right side. Then use the ▲/▼ cursor buttons to select an item to operate and press the ▶ cursor button or **ENTER** button to progress. The operation menu or dialog of the selected item appears.
- (3) Use the buttons as instructed in the OSD to operate the item.

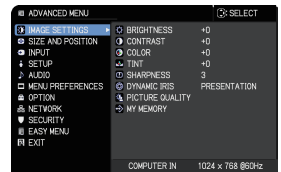

(continued on next page)

Operating

Using the menu function (continued)

3. To close the MENU, press the **MENU** button again or select EXIT and press the ◀ cursor button or **ENTER** button. If you do not do anything, the dialog automatically disappears after about 30 seconds.

NOTE • Some functions cannot be performed when a certain input port is selected, or when a certain input signal is displayed.

- To reset the operation, press **RESET** button on the remote control during the operation. Note that some items (such as LANGUAGE, VOLUME) cannot be reset.
- In the **ADVANCED MENU**, when you want to return to the previous display, press the ◀ cursor button on the remote control.

Indication in OSD (On Screen Display)

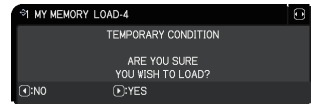
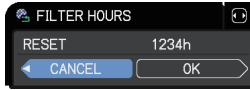

The meanings of the general words on the OSD are as follows.

Indication	Meaning
EXIT	Closes the OSD menu. It is the same as pressing the MENU button.
RETURN	Returns the menu to the previous menu.
CANCEL or NO	Cancels the operation in the present menu and returns to the previous menu.
OK or YES	Executes the prepared function or shifts the menu to the next menu.

Using the menu function (continued)

Menu items

The items contained in the menus are as below:

Menu	Items
EASY MENU (📖54)	ASPECT, KEYSTONE, 3D KEYSTONE, PICTURE MODE, ECO MODE, INSTALLATION, RESET, FILTER HOURS, LANGUAGE, ADVANCED MENU, EXIT
IMAGE SETTINGS (📖56)	BRIGHTNESS, CONTRAST, COLOR, TINT, SHARPNESS, DYNAMIC IRIS, PICTURE QUALITY, MY MEMORY
SIZE AND POSITION (📖60)	ASPECT, OVER SCAN, V POSITION, H POSITION, H PHASE, H SIZE, AUTO IMAGE
INPUT (📖63)	PROGRESSIVE, VIDEO NR, COLOR SPACE, VIDEO FORMAT, DIGITAL FORMAT, DIGITAL RANGE, COMPUTER IN, FRAME LOCK, RESOLUTION, PbyP/PIP SETUP
SETUP (📖68)	GEOMETRY CORRECTION, LAMP & FILTER, HDCR LiteLoc, PICTURE POSITION, INSTALLATION, STANDBY MODE, COLOR UNIFORMITY, OSD MESSAGE, HDMI OUTPUT, STANDBY OUTPUT
AUDIO (📖75)	VOLUME, SPEAKER, AUDIO SOURCE
MENU PREFERENCES (📖76)	LANGUAGE, MENU POSITION, BLANK, AUTO BLANK, START UP, My Screen, My Screen Lock, SOURCE NAME, TEMPLATE, Closed Caption C.C.
OPTION (📖82)	SOURCE SKIP, AUTO SEARCH, DIRECT POWER ON, AUTO POWER OFF, SHUTTER TIMER, MY BUTTON, SCHEDULE, SERVICE
NETWORK (📖95)	NETWORK INFORMATION, WIRELESS NETWORK, NETWORK SETUP, MY IMAGE, Third Party Control, OTHER OPERATION
SECURITY (📖96)	ENTER PASSWORD, SECURITY PASSWORD CHANGE, My Screen PASSWORD, PIN LOCK, TRANSITION DETECTOR, MY TEXT PASSWORD, MY TEXT DISPLAY, MY TEXT WRITING, SECURITY INDICATOR, STACK LOCK

EASY MENU

EASY MENU

Select an item from the EASY menu using the ▲/▼ cursor buttons. Then perform it according to the following table.

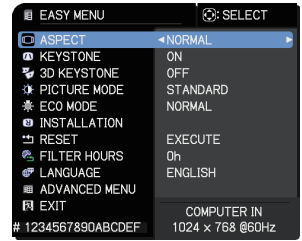

Item	Description
ASPECT	Using the ◀/▶ buttons switches the mode for aspect ratio. See the ASPECT item in SIZE AND POSITION menu (68).
KEYSTONE	Pressing the ▶ button displays the KEYSTONE dialog. See the KEYSTONE item in SETUP menu (68).
3D KEYSTONE	Pressing the ▶ button displays the 3D KEYSTONE dialog. See the 3D KEYSTONE item in SETUP menu (68).
PICTURE MODE	<p>Using the ◀/▶ buttons switches the picture mode. The picture modes are combinations of GAMMA and COLOR TEMP settings. Choose a suitable mode according to the projected source.</p> <p>STANDARD ↔ NATURAL ↔ CINEMA ↔ DYNAMIC ⇕ ⇕ USER-3 BOARD(BLACK) ⇕ ⇕ USER-2 BOARD(GREEN) ⇕ ⇕ USER-1 ↔ DICOM SIM. ↔ DAYTIME ↔ WHITEBOARD</p> <ul style="list-style-type: none"> • Lines or other noise might appear on the screen when this function is operated, but it is not a malfunction. • DICOM SIM. is the projector's DICOM® ("Digital Imaging and Communication in Medicine") simulation mode. This mode simulates the DICOM standard, which is a standard applicable to digital communications in medicine, and can be useful for displaying medical images, such as X-rays photos. This projector is not a medical device and is not compliant to the DICOM standard, and neither the projector nor the DICOM SIM. mode should be used for medical diagnosis.

(continued on next page)

Item	Description
ECO MODE	Using the ◀/▶ buttons turns off/on the Eco mode. See the ECO MODE item in SETUP menu (📖69).
INSTALLATION	Pressing the ▶ button displays the INSTALLATION dialog. See the INSTALLATION item in SETUP menu (📖71).
RESET	Selecting this item resets all of the EASY MENU items except the FILTER HOURS and LANGUAGE. A dialog is displayed for confirmation. Selecting the OK using the ▶ button performs resetting.
FILTER HOURS	The usage time of the air filter is shown in the menu. Selecting this item resets the filter hours which counts usage time of the air filter. A dialog is displayed for confirmation. Selecting OK using the ▶ button initiates the reset. See the FILTER HOURS item in SETUP menu (📖70).
LANGUAGE	Using the ◀/▶ buttons changes the display language. See the LANGUAGE item in MENU PREFERENCES (📖76).
ADVANCED MENU	Press the ▶ or ENTER button to use the menu of IMAGE SETTINGS, SIZE AND POSITION, INPUT, SETUP, AUDIO, MENU PREFERENCES, OPTION, NETWORK or SECURITY.
EXIT	Press the ◀ or ENTER button to close the OSD menu.

IMAGE SETTINGS menu

IMAGE SETTINGS menu

Select an item from the Image Settings menu using the ▲/▼ cursor buttons, and press the ► cursor button or **ENTER** button to execute the item. Then perform it according to the following table.

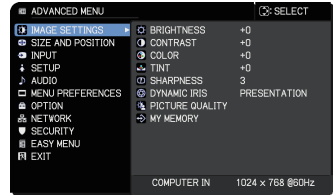

Item	Description
BRIGHTNESS	Using the ◀/▶ buttons adjusts the brightness. Dark ⇄ Light
CONTRAST	Using the ◀/▶ buttons adjusts the contrast. Weak ⇄ Strong
COLOR	Using the ◀/▶ buttons adjusts the strength of whole color. Weak ⇄ Strong <ul style="list-style-type: none"> • This item can be selected only for a video and component video signal. • For HDMI™ and HDBaseT™ signals, this item can also be selected if either (1) or (2) applies. <ol style="list-style-type: none"> (1) DIGITAL FORMAT item in the INPUT menu for selected port is set to VIDEO. (2) DIGITAL FORMAT item in the INPUT menu for selected port is set to AUTO, and the projector recognizes that it receives video signals.
TINT	Using the ◀/▶ buttons adjusts the tint. Reddish ⇄ Greenish <ul style="list-style-type: none"> • This item can be selected only for a video and component video signal. • For HDMI™ and HDBaseT™ signals, this item can also be selected if either (1) or (2) applies. <ol style="list-style-type: none"> (1) DIGITAL FORMAT item in the INPUT menu for selected port is set to VIDEO. (2) DIGITAL FORMAT item in the INPUT menu for selected port is set to AUTO, and the projector recognizes that it receives video signals.
SHARPNESS	Using the ◀/▶ buttons adjusts the sharpness. Weak ⇄ Strong <ul style="list-style-type: none"> • There may be some noise and/or the screen may flicker for a moment when an adjustment is made. This is not a malfunction.

(continued on next page)

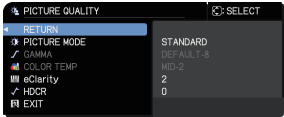
Item	Description
<p>DYNAMIC IRIS</p>	<p>Using the ▲/▼ cursor buttons changes the dynamic iris control mode. PRESENTATION ⇔ THEATER ⇔ OFF ↑—————↓ <u>PRESENTATION</u> : The dynamic iris displays the best presentation image for both bright and dark scenes. <u>THEATER</u> : The dynamic iris displays the best theater image for both bright and dark scenes. <u>OFF</u> : The dynamic iris is always open.</p> <ul style="list-style-type: none"> • The screen may flicker when the PRESENTATION or THEATER modes are selected. If this occurs, select OFF.
<p>PICTURE QUALITY</p>	<p>Selecting this item displays the PICTURE QUALITY menu.</p>  <p>Select an item using the ▲/▼ buttons, and press the ► button or the ENTER button on the remote control to execute the item.</p> <p>PICTURE MODE</p> <p>STANDARD ⇔ NATURAL ⇔ CINEMA ⇔ DYNAMIC ⇕ ⇕ USER-3 BOARD(BLACK) ⇕ ⇕ USER-2 BOARD(GREEN) ⇕ ⇕ USER-1 ⇔ DICOM SIM. ⇔ DAYTIME ⇔ WHITEBOARD</p> <p>After selecting USER-1 / USER-2 / USER-3, the following features are adjustable. Gamma, Color Temp</p> <p>GAMMA</p> <p>This feature is only available when USER-1 / USER-2 / USER-3 is selected. Using the ▲/▼ buttons switches the gamma mode.</p> <p>DEFAULT-1 ⇔ CUSTOM-1 ⇔ DEFAULT-2 ⇔ CUSTOM-2 ⇕ ⇕ CUSTOM-8 DEFAULT-3 ⇕ ⇕ DEFAULT-8 CUSTOM-3 ⇕ ⇕ CUSTOM-7 DEFAULT-4 ⇕ ⇕ DEFAULT-7 CUSTOM-4 ⇕ ⇕ CUSTOM-6 ⇔ DEFAULT-6 ⇔ CUSTOM-5 ⇔ DEFAULT-5</p>

(continued on next page)

Item	Description
<p>PICTURE QUALITY (continued)</p>	<p>GAMMA (continued)</p> <p>Selecting a mode whose name includes CUSTOM and then pressing the ► button or the ENTER button displays a dialog to help you in adjusting the mode. This function is useful when you want to change the brightness of particular tones. Choose an item using the ◀/▶ buttons, and adjust the level using the ▲/▼ buttons.</p> <ul style="list-style-type: none"> • Lines or other noise might appear on the screen when this function is operated, but it is not a malfunction.
	<p>COLOR TEMP</p> <p>This feature is only available when USER-1 / USER-2 / USER-3 is selected.</p> <p>Using the ▲/▼ buttons switches the color temperature mode.</p> <p style="text-align: center;"> HIGH ⇔ CUSTOM-1 ⇔ MID-1 ⇔ CUSTOM-2 ⇕ ⇕ CUSTOM-7 ⇔ MID-2 ⇕ ⇕ Hi-BRIGHT-3 ⇔ CUSTOM-3 ⇕ ⇕ CUSTOM-6 ⇔ LOW ⇕ ⇕ Hi-BRIGHT-2 ⇔ CUSTOM-5 ⇔ Hi-BRIGHT-1 ⇔ CUSTOM-4 </p> <p>Selecting a mode whose name includes CUSTOM and then pressing the ► button or the ENTER button displays a dialog to help you in adjusting the OFFSET and GAIN of the selected mode. OFFSET adjustments change the color intensity on the whole tones. GAIN adjustments mainly affect color intensity on the brighter tones. Choose an item using the ◀/▶ buttons, and adjust the level using the ▲/▼ buttons.</p> <ul style="list-style-type: none"> • Lines or other noise might appear on the screen when this function is operated, but it is not a malfunction.

(continued on next page)

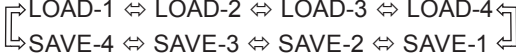

Item	Description
<p>PICTURE QUALITY (continued)</p>	<p>eClarity eClarity is a function to improve the legibility. Using the ◀/▶ buttons adjusts the sharpness. Weak ⇔ Strong</p> <ul style="list-style-type: none"> • There may be some noise and/or the screen may flicker for a moment when an adjustment is made. This is not a malfunction. • This function may not work properly when HDCR LiteLoc is enabled.
	<p>HDCR A function to show a clear picture in a bright room. Using the ◀/▶ buttons adjusts the contrast. • This function may not work properly when HDCR LiteLoc is enabled.</p>
<p>MY MEMORY</p>	<p>This projector has four memories for adjustment data (for all the items of the IMAGE SETTINGS menu). Selecting a function using the ▲/▼ buttons and pressing the ▶ or ENTER button performs each function.</p> <p style="text-align: center;">  </p> <p><u>LOAD-1, LOAD-2, LOAD-3, LOAD-4</u> Performing a LOAD function loads the data from the memory linked in the number included in the function's name, and adjusts the picture automatically depending on the data.</p> <ul style="list-style-type: none"> • The LOAD functions whose linked memory has no data are skipped. • Remember that the current adjusted condition is lost by loading data. To keep the current adjustment, save it before performing a LOAD function. • There may be some noise and the screen may flicker for a moment when loading data. This is not malfunction. • You can perform the LOAD function using MY BUTTON. See MY BUTTON item in OPTION menu (84). <p><u>SAVE-1, SAVE-2, SAVE-3, SAVE-4</u> Performing a SAVE function saves the current adjustment data into the memory linked in the number included in the function's name.</p> <ul style="list-style-type: none"> • Remember that the current data being stored of a memory is lost by saving new data into the memory.

SIZE AND POSITION menu

SIZE AND POSITION menu

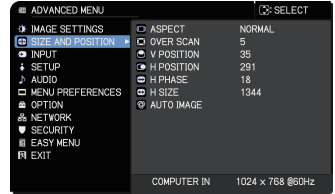
Select an item from the Size and Position menu using the ▲/▼ cursor buttons, and press the ► cursor button or **ENTER** button to execute the item. Then perform it according to the following table for selected port.



Item	Description
ASPECT	<p>Using the ▲/▼ buttons switches the mode for aspect ratio.</p> <p>For a computer signal NORMAL ⇄ 4:3 ⇄ 16:9 ⇄ 16:10 ⇄ ZOOM ⇄ NATIVE * </p> <p>For HDMI™ and HDBaseT™ signals NORMAL ⇄ 4:3 ⇄ 16:9 ⇄ 16:10 ⇄ 14:9 ⇄ ZOOM ⇄ NATIVE * </p> <p>For a video signal 4:3 ⇄ 16:9 ⇄ 16:10 * ⇄ 14:9 ⇄ ZOOM ⇄ NATIVE * </p> <p>For an input signal from the LAN port, or if there is no signal LW502/LWU502: 16:10 (fixed) LX602: 4:3 (fixed)</p> <ul style="list-style-type: none"> • The NORMAL mode keeps the original aspect ratio of the signal.

* LW502/LWU502 only
 (continued on next page)

Item	Description
OVER SCAN	<p>Using the ◀/▶ buttons adjusts the over-scan ratio. Small (It magnifies picture) ⇔ Large (It reduces picture)</p> <ul style="list-style-type: none"> • This item can be selected for a video signal. • For HDMI™ and HDBaseT™ signals, this item can also be selected if either (1) or (2) applies. <ol style="list-style-type: none"> (1) DIGITAL FORMAT item in the INPUT menu for selected port is set to VIDEO. (2) DIGITAL FORMAT item in the INPUT menu for selected port is set to AUTO, and the projector recognizes that it receives video signals.
V POSITION	<p>Using the ◀/▶ buttons adjusts the vertical position. Down ⇔ Up</p> <ul style="list-style-type: none"> • Over-adjusting the vertical position may cause noise to appear on the screen. If this occurs, reset the vertical position to the default setting. Pressing the RESET button when the V POSITION is selected resets the V POSITION to the default setting. • When this function is performed on a video signal, the range of this adjustment depends on OVER SCAN (🔲 above) setting. You cannot adjust when OVER SCAN is set to 10. • This function is unavailable for a signal from the LAN, HDMI 1, HDMI 2 or HDBaseT port.
H POSITION	<p>Using the ◀/▶ buttons adjusts the horizontal position. Right ⇔ Left</p> <ul style="list-style-type: none"> • Over-adjusting the horizontal position may cause noise to appear on the screen. If this occurs, reset the horizontal position to the default setting. Pressing the RESET button when the H POSITION is selected resets the H POSITION to the default setting. • When this function is performed on a video signal, the range of this adjustment depends on OVER SCAN (🔲 above) setting. You cannot adjust when OVER SCAN is set to 10. • This function is unavailable for a signal from the LAN, HDMI 1, HDMI 2 or HDBaseT port.

(continued on next page)

SIZE AND POSITION menu

Item	Description
H PHASE	<p>Using the ◀/▶ buttons adjusts the horizontal phase to eliminate flicker. Right ⇔ Left</p> <ul style="list-style-type: none"> • This item can be selected only for a computer signal or a component video signal. • This function is unavailable for a signal from the LAN, HDMI 1, HDMI 2 or HDBaseT port.
H SIZE	<p>Using the ◀/▶ buttons adjusts the horizontal size. Small ⇔ Large</p> <ul style="list-style-type: none"> • This item can be selected only for a computer signal. • This function is unavailable for a signal from the LAN, VIDEO, HDMI 1, HDMI 2 or HDBaseT port. • When this adjustment is excessive, the picture may not be displayed correctly. If this occurs, reset the adjustment by pressing the RESET button on the remote control during this operation. • Images might appear degraded when this function is operated, but it is not a malfunction.
AUTO IMAGE	<p>Selecting this item performs the automatic adjustment feature.</p> <p>For a computer signal The vertical position, the horizontal position and the horizontal phase are automatically adjusted. Make sure that the application window is set to its maximum size prior to attempting to use this feature. A dark picture may still be incorrectly adjusted. Use a bright picture when adjusting.</p> <p>For a video signal The video format best suited for the respective input signal is selected automatically. This function is available only when the AUTO is selected for the VIDEO FORMAT item in the INPUT menu (📄64). The vertical position and horizontal position are automatically set to the default.</p> <ul style="list-style-type: none"> • The automatic adjustment operation requires approximately 10 seconds. Note that it may not function correctly with some input. • When this function is performed for a video signal, an extra line may appear outside a picture. • When this function is performed for a computer signal, a black frame may be displayed on the edge of the screen, depending on the computer model. • The items adjusted by this function may vary when the FINE or DISABLE is selected for the AUTO IMAGE ADJUST item of the SERVICE item in the OPTION menu (📄88).

INPUT menu

Select an item from the Input menu using the ▲/▼ cursor buttons, and press the ► cursor button or **ENTER** button to execute the item. Then perform it according to the following table.

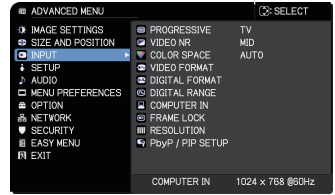

Item	Description
<p>PROGRESSIVE</p>	<p>Using the ▲/▼ buttons switches the progress mode. TV ⇄ FILM ⇄ OFF ↑—————↑</p> <ul style="list-style-type: none"> • This function works only for a video signal, component video signal (of 480i@60 or 1080i@60), an HDMI™ signal (of 480i@60 or 1080i@60), and HDBaseT™ signal (of 480i@60 or 1080i@60). • When TV or FILM is selected, the screen image is sharp. FILM adapts to the 2-3 Pull-Down conversion system. But these may cause a certain defect (for example, jagged line) of the picture for a quick moving object. If this occurs, select OFF, even if the screen image loses sharpness.
<p>VIDEO NR</p>	<p>Using the ▲/▼ buttons switches the noise reduction mode. HIGH ⇄ MID ⇄ LOW ↑—————↑</p> <ul style="list-style-type: none"> • This function works only for a video signal, component video signal (of 480i@60 or 1080i@60), an HDMI™ signal (of 480i@60 or 1080i@60), and HDBaseT™ signal (of 480i@60 or 1080i@60).
<p>COLOR SPACE</p>	<p>Using the ▲/▼ buttons switches the mode for color space. AUTO ⇄ RGB ⇄ SMPTE240 ⇄ REC709 ⇄ REC601 ↑—————↑</p> <ul style="list-style-type: none"> • This item can be selected only for a computer signal (except for signals from the LAN port). • The AUTO mode automatically selects the optimum mode. • The AUTO operation may not work correctly at some signals. If this occurs, select a suitable mode except AUTO.

(continued on next page)

INPUT menu

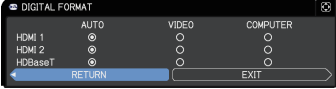

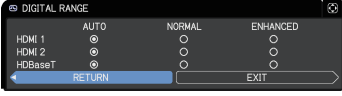
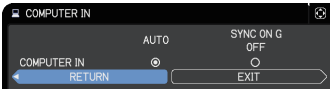
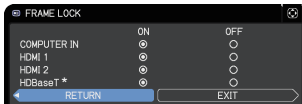

Item	Description
<p>VIDEO FORMAT</p>	<p>The video format for VIDEO port can be set.</p> <p>Using the ◀/▶ buttons switches the mode for video format.</p>  <p>AUTO ⇔ NTSC ⇔ PAL ⇔ SECAM ↳ N-PAL ⇔ M-PAL ⇔ NTSC4.43 ↵</p> <ul style="list-style-type: none"> • This item is used only for a video signal from the VIDEO port. • The AUTO mode automatically selects the optimum mode. • The AUTO operation may not work well for some signals. If the picture becomes unstable (for example, an irregular picture, lack of color), select the mode according to the input signal.
<p>DIGITAL FORMAT</p>	<p>The digital format of HDMI™ input signals from the HDMI 1, HDMI2 and HDBaseT * ports can be set.</p> <p>*LW502/LWU502 only</p>  <p>(1) Use the ▲/▼ buttons to select the port to be set. (2) Use the ◀/▶ buttons to select the digital format.</p> <p>AUTO ⇔ VIDEO ⇔ COMPUTER ↳—————↵</p> <p><u>AUTO</u>: automatically sets the optimum mode. <u>VIDEO</u>: sets the suitable mode for DVD signals. <u>COMPUTER</u>: sets the suitable mode for computer signals.</p> <ul style="list-style-type: none"> • When the COMPUTER is selected, the function OVER SCAN (SIZE AND POSITION) menu is unavailable.

(continued on next page)

Item	Description
<p>DIGITAL RANGE</p>	<p>The digital range of HDMI™ input signals from the HDMI 1, HDMI 2 and HDBaseT * ports can be set. *LW502/LWU502 only</p>  <p>(1) Use the ▲/▼ buttons to select the port to be set. (2) Use the ◀/▶ buttons to select the digital range. AUTO ⇔ NORMAL ⇔ ENHANCED</p> <p>↑—————↓</p> <p><u>AUTO</u>: automatically sets the optimum mode. <u>NORMAL</u>: sets the suitable mode for DVD signals. (16-235) <u>ENHANCED</u>: sets the suitable mode for computer signals. (0-255)</p> <ul style="list-style-type: none"> • If the contrast of the screen image is too strong or weak, try finding a more suitable mode.
<p>COMPUTER IN</p>	<p>The computer input signal type for COMPUTER IN port can be set. Use the ◀/▶ buttons to select the computer input signal type.</p>  <p>AUTO ⇔ SYNC ON G OFF</p> <ul style="list-style-type: none"> • Selecting the AUTO mode, you can input a sync on G signal or component video signal from the port. • In the AUTO mode, the picture may be distorted with certain input signals. If this occurs, remove the signal connector so that no signal is received and select the SYNC ON G OFF, and then reconnect the signal.
<p>FRAME LOCK</p>	<p>Set the frame lock function on/off for each port.</p>  <p>*LW502/LWU502 only</p> <p>(1) Use the ▲/▼ buttons to select the input ports. (2) Use the ◀/▶ buttons to turn the frame lock function on/off . ON ⇔ OFF</p> <ul style="list-style-type: none"> • This item can be performed only on a signal with a vertical frequency of 59 to 61 Hz. • When ON is selected, moving pictures are displayed more smoothly.

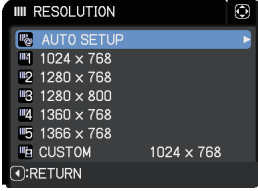
(continued on next page)

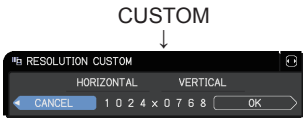
INPUT menu

Item	Description
<p>RESOLUTION</p>	<p>The resolution for the COMPUTER IN input signal can be set on this projector.</p> <p>(1) In the INPUT menu select the RESOLUTION using the ▲/▼ buttons and press the ► button. The RESOLUTION menu is displayed.</p>  <p>(2) In the RESOLUTION menu select the resolution you want to display using the ▲/▼ buttons. Selecting AUTO SETUP sets a resolution appropriate to the input signal.</p> <p>(3) Pressing the ► or ENTER button when selecting a STANDARD resolution automatically adjusts the horizontal and vertical positions, clock phase and horizontal size. The INPUT INFORMATION dialog is displayed.</p>  <p>(4) To set a custom resolution, use the ▲/▼ buttons to select the CUSTOM and the RESOLUTION CUSTOM box is displayed. Set the HORIZONTAL and VERTICAL resolutions using the ▲/▼/◀/▶ buttons. This function may not support all resolutions.</p>  <p>(5) Move the cursor to OK on the screen and press the ► or ENTER button. The message "ARE YOU SURE YOU WISH TO CHANGE RESOLUTION?" appears. To save the setting, press the ► button. The horizontal and vertical positions, clock phase and horizontal size are automatically adjusted. The INPUT INFORMATION dialog is displayed.</p>  <p>(6) To revert to the previous resolution without saving changes, move the cursor to CANCEL on screen and press the ◀ or ENTER button. The screen then returns to the RESOLUTION menu displaying the previous resolution.</p> <ul style="list-style-type: none"> • For some pictures, this function may not work well.

(continued on next page)

Item	Description
<p>PbyP / PIP SETUP</p>	<p>PIP POSITION Using ▲/▼ buttons on the remote control changes the position of sub area in PIP mode (p.50).</p>
	<p>PbyP / PIP FRAME LOCK Select the screen that enables FRAME LOCK function when using PbyP or PIP. LEFT / PRIMARY: Enables FRAME LOCK function for input on left screen of PbyP or on primary area of PIP.</p>
	<p>RIGHT / SECONDARY: Enables FRAME LOCK function for input on right screen of PbyP or on secondary area of PIP.</p>

SETUP menu

Select an item from the Setup menu using the ▲/▼ cursor buttons, and press the ► cursor button or **ENTER** button to execute the item. Then perform it according to the following table.

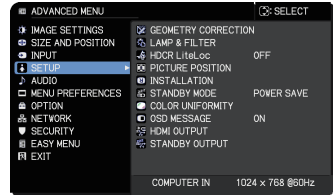

Item	Description
GEOMETRY CORRECTION	<p>KEYSTONE Selecting this item displays the KEYSTONE dialog. For details, see KEYSTONE in Correcting the distortion (438).</p> <ul style="list-style-type: none"> • When the zoom adjustment is set to the TELE (telephoto focus), this function may be excessive. This function should be used when the zoom adjustment is set to the full WIDE (wide-angle focus). • When the horizontal lens shift is not set to the center, this function may not work correctly. • This function is unavailable when the screen is activated by 3D KEYSTONE (439), and WARPING (440).
	<p>3D KEYSTONE Selecting this item displays the 3D KEYSTONE dialog. For details, see 3D KEYSTONE in Correcting the distortion (439).</p> <ul style="list-style-type: none"> • This function is unavailable when the screen is activated by KEYSTONE (438), and WARPING (440).
	<p>WARPING Selecting this item displays the WARPING dialog. For details, see Application Manual of this feature.</p> <ul style="list-style-type: none"> • This function is unavailable when the screen is activated by KEYSTONE (438) and 3D KEYSTONE (439).
	<p>EDGE BLENDING Selecting this item displays the EDGE BLENDING dialog. For details, see EDGE BLENDING feature (441 ~ 44).</p>

(continued on next page)

Item	Description
<p>GEOMETRY CORRECTION (continued)</p>	<p>TEST PATTERNS Select PATTERN with ▲/▼ buttons. Displayed pattern [Off/1/2/3/4/5/6] can be switched with ◀/▶ buttons. PATTERN 1: Frame PATTERN 2: Red Grid PATTERN 3: Green Grid PATTERN 4: Blue Grid PATTERN 5: Vertical 9 steps PATTERN 6: Horizontal 9 steps OFF: Displays the input signal.</p>
<p>LAMP & FILTER</p>	<p>Selecting this item displays the LAMP & FILTER menu. Select an item using the ▲/▼ buttons, and press the ▶ button or the ENTER button on the remote control to execute the item.</p> <div data-bbox="748 467 1033 582" style="border: 1px solid black; padding: 5px; margin: 10px 0;"> </div> <p>ECO MODE Using the ▲/▼ buttons switches the Eco mode. NORMAL ⇔ ECO</p> <ul style="list-style-type: none"> • When the item other than NORMAL is selected, acoustic noise and screen brightness are reduced. <p>LAMP HOURS The lamp hours is the usage time of the lamp, counted after the last resetting. It is shown in the LAMP & FILTER menu. Pressing the RESET button on the remote control or the ▶ button of the projector displays a dialog. To reset the lamp hours, select the OK using the ▶ button. CANCEL ⇔ OK</p> <ul style="list-style-type: none"> • For the lamp replacement, see the section Replacing the lamp (103). • The HDCR LiteLoc function does not work properly unless LAMP HOURS is initialized when replacing a lamp.

(continued on next page)

Item	Description
<p>LAMP & FILTER (continued)</p>	<p>FILTER HOURS Displays the usage time of the air filter, counted after the last resetting. It is shown in the LAMP & FILTER menu. Pressing the RESET button on the remote control or the ► button of the projector displays a dialog. To reset the filter hours, select the OK using the ► button. CANCEL ⇨ OK</p> <ul style="list-style-type: none"> • Reset the filter hours only when you have cleaned or replaced the air filter, for a suitable indication about the air filter. • For the air filter cleaning, see the section Cleaning and replacing the air filter (105).
	<p>FILTER MESSAGE Use the ▲/▼ button to set the timer for notifying by the message when to replace the filter unit 1000h ⇨ 2000h ⇨ 5000h ⇨ 10000h ⇨ 15000h ⇨ 20000h ⇨ 25000h ⇨ 30000h ⇨ OFF After choosing an item except OFF, the message “REMINDER *** HRS PASSED” appears after the timer reaches the interval time set by this feature. When the OFF is chosen, the message does not appear. Use this feature to keep the air filter clean, setting the suitable time according to your environment of this projector.</p> <ul style="list-style-type: none"> • Clean the filter periodically. If the air filter becomes to be blocked by dust or other matter, the internal temperature rises, which could cause malfunction, or reduce the lifetime of the projector. • Be careful with the operating environment of the projector and the condition of the filter unit.
<p>HDCR LiteLoc</p>	<p>When this function is enabled, automatic image correction is performed to maintain visibility according to lamp deterioration.</p> <ul style="list-style-type: none"> • This function may not work properly when HDCR/eClarity is set to other than 0. • This function does not work properly unless LAMP HOURS is initialized when replacing a lamp.

(continued on next page)

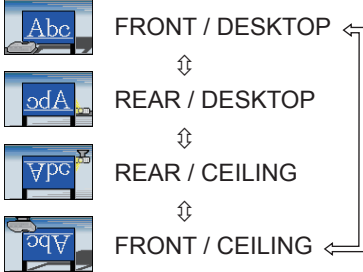

Item	Description
<p>PICTURE POSITION</p>	<p>Using the ▲/▼/◀/▶ cursor buttons selects the required picture position. The PICTURE POSITION is not changed if any of the following cases apply.</p> <ul style="list-style-type: none"> • There is no non-display area (black display or background display) or it is not displayed on the screen. • One of the following messages is displayed on the screen: "NO INPUT IS DETECTED" "SYNC IS OUT OF RANGE" "INVALID SCAN FREQ." • The BLANK or TEMPLATE function is selected.
<p>INSTALLATION</p>	<p>Pressing the ► button displays the dialog for changing the INSTALLATION setting.</p> <div style="display: flex; align-items: center;">  <div style="margin-left: 10px;"> <p>FRONT / DESKTOP</p> <p>⇕</p> <p>REAR / DESKTOP</p> <p>⇕</p> <p>REAR / CEILING</p> <p>⇕</p> <p>FRONT / CEILING</p> </div> </div> <p>Use the ▲/▼ buttons to select the required setting on the INSTALLATION dialog, and press the ENTER button of the remote control or the INPUT button of the projector to execute. If TRANSITION DETECTOR is ON and the INSTALLATION status is changed, the TRANSITION DETECTOR ON alarm (🔊99) is displayed when the projector is restarted.</p>

(continued on next page)

SETUP menu

Item	Description
STANDBY MODE	<p>Using ▲/▼ buttons switches the standby mode setting between NORMAL and POWER SAVE.</p> <p>NORMAL ⇔ POWER SAVE</p> <ul style="list-style-type: none"> • When POWER SAVE is selected, the RS-232C communication control except to turn the projector on and the network function are disabled while the projector is in the standby mode. If the COMMUNICATION TYPE in the COMMUNICATION menu is set to NETWORK BRIDGE, all of the RS-232C commands are disabled (p.90). • When POWER SAVE is selected, STANDBY OUTPUT is invalid. • When POWER SAVE is selected, the HDMI Link and HDBaseT™ functions are disabled while the projector is in the standby mode. • This function is available only when OFF is selected for STACK MODE. (OPTION menu > SERVICE > COMMUNICATION > STACK). • When POWER SAVE is selected, SCHEDULE function (Ex. POWER-ON) at STANDBY MODE is not operated.
COLOR UNIFORMITY	<p>Selects image level and region that must be required to correct to be corrected, and adjusts Color Balance.</p> <p>Divides the screen into nine regions and adjusts gain of R/G/B of each region.</p>

(continued on next page)

Item	Description
<p>OSD MESSAGE</p>	<p>Using the ▲/▼ buttons turns on/off the message function. ON ⇄ OFF ⇄ HIDE </p> <p>■OFF : The following message functions do not work. “AUTO IN PROGRESS” while automatically adjusting. “NO INPUT IS DETECTED” “SYNC IS OUT OF RANGE” “INVALID SCAN FREQ.” “NOT AVAILABLE” “Searching....” while searching for the input. “Detecting....” while an input signal is detected. The indication of the input signal displayed by changing. The indication of the aspect ratio displayed by changing. The indication of the PICTURE MODE displayed by changing. The indication of the DYNAMIC IRIS displayed by changing. The indication of the MY MEMORY displayed by changing. The indication of “FREEZE” and “II” while freezing the screen by pressing the FREEZE button. The indication of the TEMPLATE displayed by changing. The indication of the ECO MODE displayed by changing.</p> <p>■HIDE : All message functions do not work. The following buttons function: STANDBY, ON</p> <ul style="list-style-type: none"> To change this function, follow the steps below. <ol style="list-style-type: none"> Press the OSD MSG button on the remote control for three seconds. The OSD is displayed. While this OSD is displayed, press the OSD MSG button again on the remote control. Toggle and change the function. <p>ON ⇄ OFF ⇄ HIDE </p>

(continued on next page)

SETUP menu

Item	Description
HDMI OUTPUT	To select the image output on the HDMI OUT in the normal operation.
STANDBY OUTPUT	<p><u>AUDIO OUT</u> To select the sound output in the standby mode.</p> <p><u>HDMI OUT</u> To select the image output on the HDMI OUT in the standby mode.</p> <p><u>MONITOR OUT</u> To select the image output on the MONITOR OUT in the standby mode.</p> <ul style="list-style-type: none"> • When the STANDBY MODE is set to POWER SAVE, the STANDBY OUTPUT menu cannot be operated.

AUDIO menu

Select an item from the Audio menu using the ▲/▼ cursor buttons, and press the ► cursor button or the ENTER button to execute the item. Then perform it according to the following table.

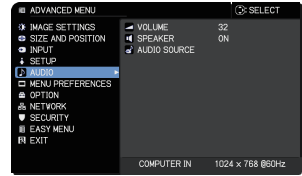

Item	Description						
VOLUME	Using the ◀/▶ buttons adjusts the volume of the audio output. Low ⇄ High						
SPEAKER	Using the ▲/▼ buttons turns on/off the built-in speaker. ON ⇄ OFF When OFF is selected, the built-in speaker does not work.						
AUDIO SOURCE	<p>While the image signal from the input port chosen in step (1) is projected, the audio signal from the input port selected in step (2) is output to both the AUDIO OUT port and built-in speaker of this projector. However, the built-in speaker does not work when SPEAKER is set to OFF.</p> <p>(1) Choose a picture input port using the ▲/▼ buttons.</p> <p>(2) Select an audio input port or the mute icon using the ◀/▶ buttons. The icons indicate the following;</p> <table border="0" data-bbox="336 845 873 989"> <tr> <td>No.1: AUDIO IN1 port</td> <td>No.2: AUDIO IN2 port</td> </tr> <tr> <td>No.3: HDMI 1 port</td> <td>No.4: HDMI 2 port</td> </tr> <tr> <td>No.5: HDBaseT port *</td> <td>No.6: LAN port</td> </tr> </table> <p>⊗ : mutes the sound * LW502/LWU502 only</p> <ul style="list-style-type: none"> • Audio input from port numbers 3 to 6 can only be selected by each of the picture input ports and AUDIO OUT STANDBY. • Closed Caption C.C. is automatically activated when ⊗ is selected and an input signal containing Closed Caption C.C. is received. This function is available only when the signal is NTSC for VIDEO or COMPUTER IN, and when AUTO is selected for DISPLAY in the Closed Caption C.C. menu under the MENU PREFERENCES (M81). • For the setting of AUDIO OUT, refer to AUDIO OUT of STANDBY OUTPUT in the SETUP menu. 	No.1: AUDIO IN1 port	No.2: AUDIO IN2 port	No.3: HDMI 1 port	No.4: HDMI 2 port	No.5: HDBaseT port *	No.6: LAN port
No.1: AUDIO IN1 port	No.2: AUDIO IN2 port						
No.3: HDMI 1 port	No.4: HDMI 2 port						
No.5: HDBaseT port *	No.6: LAN port						



MENU PREFERENCES

MENU PREFERENCES

Select an item from the Menu Preferences using the ▲/▼ cursor buttons, and press the ► cursor button or **ENTER** button to execute the item. Then perform it according to the following table.

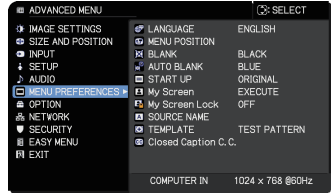



Item	Description
<p>LANGUAGE</p>	<p>Using the ▲/▼/◀/▶ buttons switches the OSD (On Screen Display) language. ENGLISH ↔ FRANÇAIS ↔ DEUTSCH ↔ ESPAÑOL ⤴ (shown in the LANGUAGE dialog) ⤵ Press the ENTER or My Screen Lock button to save the language setting.</p>
<p>MENU POSITION</p>	<p>Using the ▲/▼/◀/▶ buttons adjusts the menu position. To quit the operation, press the MENU button on the remote control or do not perform any operation for about 10 seconds.</p>
<p>BLANK</p>	<p>Using the ▲/▼ buttons switches the mode for the blank screen. The blank screen is a screen for the temporarily blanking feature (46). It is displayed by pressing the BLANK button on the remote control. My Screen ↔ ORIGINAL ↔ BLUE ↔ WHITE ↔ BLACK ⤴-----⤵ <u>My Screen</u> : Screen can be registered by the My Screen item (78). <u>ORIGINAL</u> : Screen preset as the standard screen. <u>BLUE, WHITE, BLACK</u> : Plain screens in each color. • To avoid the image burning into the screen, the My Screen or ORIGINAL screen changes to the AUTO BLANK screen after several minutes.</p>

(continued on next page)

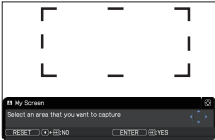

Item	Description
<p>AUTO BLANK</p>	<p>Using the ▲/▼ buttons switches the mode for the AUTO BLANK screen.</p> <p>BLUE ⇔ WHITE ⇔ BLACK</p> <p style="text-align: center;">↑—————↑</p> <ul style="list-style-type: none"> • To avoid remaining as an afterimage, displayed image changes to the designated blank color screen by AUTO BLANK after several minutes at the following conditions. - When My Screen or ORIGINAL is displayed as BLANK screen. - When start-up screen is displayed.
<p>START UP</p>	<p>Using the ▲/▼ buttons switches the mode for the start-up screen. The start-up screen is a screen displayed when no signal or an unsuitable signal is detected.</p> <p>My Screen ⇔ ORIGINAL ⇔ OFF</p> <p style="text-align: center;">↑—————↑</p> <p><u>My Screen</u> : Screen can be registered by the My Screen item (📖78).</p> <p><u>ORIGINAL</u> : Screen preset as the standard screen.</p> <p><u>OFF</u> : Plain black screen.</p> <ul style="list-style-type: none"> • To avoid remaining as an afterimage, the START UP screen changes to the AUTO BLANK screen after several minutes. • When the ON is selected to the My Screen PASSWORD item in the SECURITY menu (📖97), the START UP is fixed to My Screen.

(continued on next page)

MENU PREFERENCES

Item	Description
<p>My Screen</p>	<p>You can capture an image for use as a My Screen image which can be used as the BLANK screen and START UP screen. Display the image you want to capture before executing the following procedure.</p> <p>(1) Selecting this item displays a dialog titled “My Screen”. It asks you if you start capturing an image from the current screen.</p>  <p>Wait for the target image to be displayed, and press the ENTER or ENTER button when the image is displayed. The image freezes and the frame for capturing appears.</p> <p>To stop performing, press the RESET button on the remote control.</p> <p>(2) Using the ▲/▼/◀/▶ buttons adjusts the frame position.</p>  <p>Move the frame to the position of the image which you want to use. The frame may not be able to be moved for some input signals.</p> <p>To start registration, press the ENTER button on the remote control or INPUT button on the control panel.</p>  <p>To restore the screen and return to the previous dialog, press the RESET button on the remote control or press the ◀ and INPUT buttons at the same time on the control panel.</p> <p>Registration may take several minutes.</p> <p>When the registration is completed, the registered screen and the following message is displayed for several seconds:</p> <p>“My Screen registration is finished.”</p> <p>If the registration failed, the following message is displayed:</p> <p>“A capturing error has occurred. Please try again.”</p> <ul style="list-style-type: none"> • This function cannot be selected when ON is selected for the My Screen Lock item (📖79). • This function cannot be selected when ON is selected for the My Screen PASSWORD item in SECURITY menu (📖97). • This function is unavailable for a signal from the LAN, HDMI 1, HDMI 2 or HDBaseT port.

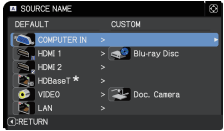
(continued on next page)

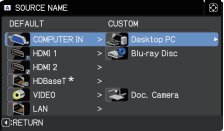
Item	Description
<p>My Screen Lock</p>	<p>Using the ▲/▼ buttons turns on/off the My Screen lock function. ON ⇌ OFF</p> <p>When the ON is selected, the item My Screen is locked. Use this function for protecting the current My Screen.</p> <ul style="list-style-type: none"> This function cannot be selected when the ON is selected to the My Screen PASSWORD item in SECURITY menu (📖 97).
<p>SOURCE NAME</p>	<p>Each input port for this projector can have a name applied to it.</p> <ol style="list-style-type: none"> Use the ▲/▼ buttons on the MENU PREFERENCES to select SOURCE NAME and press the ► or ENTER button. The SOURCE NAME menu is displayed. Use the ▲/▼ buttons on the SOURCE NAME menu to select the port to be named and press the ► button. The SOURCE NAME dialog is displayed. Right side of the menu is blank until a name is specified. Select an icon you want to assign to the port in the SOURCE NAME dialog. The name assigned to the port is automatically switched according to your icon selection. Press the ENTER or ↵ button to determine your icon selection. Select a number you want to assign to the port along with the icon. You can select the number either from blank (no number assigned), 1, 2, 3, or 4. Then press the ENTER or ↵ button. If you want to modify the name assigned to the port, select CUSTOM NAME and press the ENTER or ↵ button.    

* LW502/LWU502 only
(continued on next page)

MENU PREFERENCES

Item	Description
<p>SOURCE NAME (continued)</p>	<p>(6) The current name is displayed on the first line. Use the ▲/▼/◀/▶ buttons and the ENTER or ↵ button to select and enter characters. To erase one character at a time, press the RESET button or press the ◀ and ↵ button simultaneously. Also if you move the cursor to DELETE or CLEAR ALL on screen and press the ENTER or ↵ button, one or all characters are erased. The name can be a maximum of 16 characters.</p> <p>(7) To change an already inserted character, press the ▲ button to move the cursor to the first line, and use the ◀/▶ buttons to move the cursor on the character to be changed. After pressing the ENTER or ↵ button, the character is selected. Then, follow the same procedure as described at the item (6) above.</p> <p>(8) To finish entering text, move the cursor to the OK on screen and press the ▶, ENTER or ↵ button. To revert to the previous name without saving changes, move the cursor to the CANCEL on screen and press the ◀, ENTER or ↵ button.</p>
<p>TEMPLATE</p>	<p>Using the ▲/▼ cursor buttons switches the mode for the template screen.</p> <p>Press the ▶ cursor (or the ENTER) button to display the selected template, and press the ◀ cursor button to close the displayed screen.</p> <p>The last selected template is displayed when the MY BUTTON allocated to the TEMPLATE function is pressed (84).</p> <p>TEST PATTERN ⇄ DOT-LINE1 ⇄ DOT-LINE2 ⇄ DOT-LINE3 ⇕ ⇕</p> <p>STACK ⇄ MAP2 ⇄ MAP1 ⇄ CIRCLE2 ⇄ CIRCLE1 ⇄ DOT-LINE4</p> <p>You can turn a map upside down and scroll it horizontally when MAP1 or MAP2 is selected. To invert or scroll the map, display the guidance by pressing the RESET button on the remote three seconds or more when MAP1 or MAP2 appears.</p>

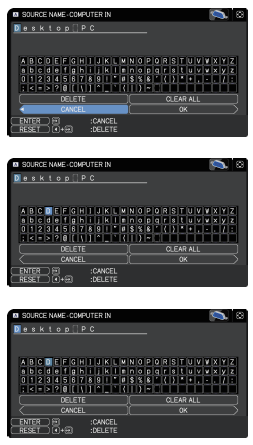

(continued on next page)

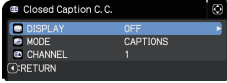
Item	Description
<p>Closed Caption C.C.</p>	<p>The Closed Caption C.C. is the function that displays a transcript or dialog of the audio portion of a video, files or other presentation or other relevant sounds. It must have NTSC format video or 480i@60 format component video source supporting Closed Caption C.C. feature to use this function. It may not work properly, depending on equipment or signal source. In this case, turn off the Closed Caption.</p> 
	<p>DISPLAY Select Closed Caption DISPLAY setting from following options using ▲/▼ buttons. AUTO ⇄ ON ⇄ OFF ↑—————↑</p> <p><u>AUTO</u> : Closed Caption automatically appears when the input signal (Closed Caption C.C. compatible) from the port with the mute icon set at AUDIO SOURCE is selected. <u>ON</u> : Closed Caption is on. <u>OFF</u> : Closed Caption is off.</p> <ul style="list-style-type: none"> • The caption is not displayed when the OSD menu is active. • The Closed Caption is the function to display the dialogue, narration, and/or sound effects of a television program or other video sources. The Closed Caption availability depends upon broadcaster and/or content.
	<p>MODE Select Closed Caption MODE setting from following options using ▲/▼ buttons. CAPTIONS ⇄ TEXT</p> <p><u>CAPTIONS</u> : Display Closed Caption. <u>TEXT</u> : Display Text data, which is for additional information such as news reports or a TV program guide. The information covers the entire screen. Not all of the Closed Caption C.C. program has Text information.</p>
	<p>CHANNEL Select Closed Caption CHANNEL from following options using ▲/▼ buttons. 1 ⇄ 2 ⇄ 3 ⇄ 4 ↑—————↑</p> <p>1: Channel 1, primary channel / language 2: Channel 2 3: Channel 3 4: Channel 4</p> <p>The channel data may vary, depending on the content. Some channel might be used for secondary language or empty.</p>

OPTION menu

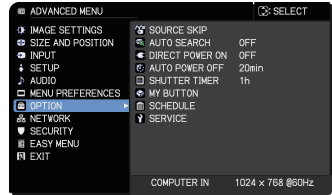

OPTION menu

Select an item from the Option menu using the ▲/▼ cursor buttons, and press the ► cursor button or **ENTER** button to execute the item. Then perform it according to the following table.

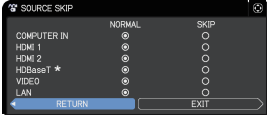

Item	Description
<p>SOURCE SKIP</p>	<p>The ports can be set to be ignored in searching by the AUTO SEARCH function (see below) or in selecting by buttons on the control panel.</p>  <p>(1) Choose a picture input port using the ▲/▼ buttons. (2) Using the ◀/▶ buttons turns on/off the SOURCE SKIP function. NORMAL ⇔ SKIP</p> <p>The port that is set to SKIP is ignored.</p> <ul style="list-style-type: none"> You cannot set SKIP to all ports at the same time. This setting is not valid when in the PbyP /PIP mode (see 47).
<p>AUTO SEARCH</p>	<p>Using the ▲/▼ buttons turns on/off the automatic signal search function. ON ⇔ OFF</p> <p>When ON is selected, detecting no signal automatically cycles through input ports in the following order. The search is started from the current port. When an input is found, the projector stops searching and display the image.</p> <pre> LAN ⇔ COMPUTER IN ⇔ HDMI 1 ↑ ↓ VIDEO ⇔ HDBaseT* ⇔ HDMI 2 </pre>

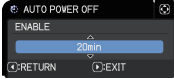
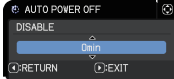
* LW502/LWU502 only
 (continued on next page)

Item	Description
<p>DIRECT POWER ON</p>	<p>Using the ▲/▼ buttons turns on/off the DIRECT POWER ON function.</p> <p>ON ⇔ OFF</p> <p>When set to ON, the lamp in projector is automatically turned on without the usual procedure (☐ 30), only when the projector is supplied with the power after the power was cut while the lamp was on.</p> <ul style="list-style-type: none"> • This function does not work as long as the power has been supplied to the projector while the lamp is off. • After turning the lamp on by the DIRECT POWER ON function, if neither input nor operation is detected for about 30 minutes, the projector is turned off, even though the AUTO POWER OFF function (☐ below) is disabled.
<p>AUTO POWER OFF</p>	<p>Using the ▲/▼ buttons adjusts the time to count down to automatically turn the projector off.</p> <p>Long (max. 99 minutes) ⇔ Short (min. 0 minute = DISABLE)</p> <div style="display: flex; justify-content: space-around; align-items: center;">   </div> <p>When the time is set to 0, the projector is not turned off automatically.</p> <p>When the time is set to 1 to 99, and when the passed time with no-signal or an unsuitable signal reaches at the set time, the projector lamp is turned off.</p> <p>If one of the projector's buttons or the remote control buttons is pressed or one of the commands (except get commands) is transmitted to the CONTROL port during the corresponding time, projector is not turned off.</p> <p>Refer to the section Turning off the power (☐ 31).</p>
<p>SHUTTER TIMER</p>	<p>Using the ▲/▼ buttons sets the time from closing the lens shutter to automatically turning the projector off.</p> <p>1h ⇔ 3h ⇔ 6h</p>  <ul style="list-style-type: none"> • The shutter opens automatically when turning the projector on again.

(continued on next page)

Item	Description
<p>MY BUTTON</p>	<p>This item is to assign one of the following functions to MY BUTTON (1 to 2) on the remote control (7).</p> <p>(1) Use the ▲/▼ buttons on the MY BUTTON menu to select a button from MY BUTTON - 1 to 4 and press the ► or ENTER button to display the MY BUTTON setup dialog.</p> <p>(2) Then using the ▲/▼/◀/► buttons sets one of the following functions to the chosen button. Press the ENTER or ◀ button to save the setting.</p> <p>MY IMAGE: Displays the MY IMAGE menu. (5. My Image Function in the Network Guide)</p> <p>MESSENGER: Turns the messenger text displayed on the screen on/off (6. Messenger Function in the Network Guide). When there is no transferred text data to display, the message "NO MESSENGER DATA" appears.</p> <p>SHUTTER: Turns the lens shutter closed and opened.</p> <p>PbyP / PIP SWAP: Swaps the picture on the right with one on the left in the PbyP mode. Swaps the primary picture and the secondary picture in the PIP mode. (50)</p> <p>PIP POSITION: Toggles the PIP position.</p> <p>eClarity: Turns on/off the eClarity dialog (59).</p> <p>HDCR: Turns on/off the HDCR dialog (59).</p> <p>INFORMATION: Displays SYSTEM INFORMATION → INPUT INFORMATION (94) → NETWORK INFORMATION.</p> <p>MY MEMORY: Loads one of adjustment data stored (59). When more than one data are saved, the adjustment changes every time the MY BUTTON is pressed. When no data is saved in memory, the dialog "No saved data" appears.</p> <div data-bbox="826 935 986 954" style="border: 1px solid black; padding: 2px; width: fit-content;"> <p>⇒ No saved data</p> </div> <p>When the current adjustment is not saved to memory, the dialog as shown in the right appears.</p> <div data-bbox="781 975 1033 1031" style="border: 1px solid black; padding: 2px; width: fit-content;"> <p>Temporary condition MY BUTTON :Recall saved parameters MY MEMORY 1 :Exit</p> </div> <p>To keep the current adjustment, press the ► button to exit. Otherwise loading a data overwrites the current adjusted condition.</p> <p>DYNAMIC IRIS: Changes the dynamic iris mode (57).</p> <p>PICTURE MODE: Changes the PICTURE MODE (57).</p> <p>FILTER RESET: Displays the filter hours reset confirmation dialogue (70).</p> <p>TEMPLATE: Makes the template pattern selected to the TEMPLATE item (80) appear or disappear.</p> <p>RESOLUTION: Turns on/off the RESOLUTION dialog (66).</p> <p>ECO MODE: Changes the ECO MODE dialog (69).</p>

(continued on next page)

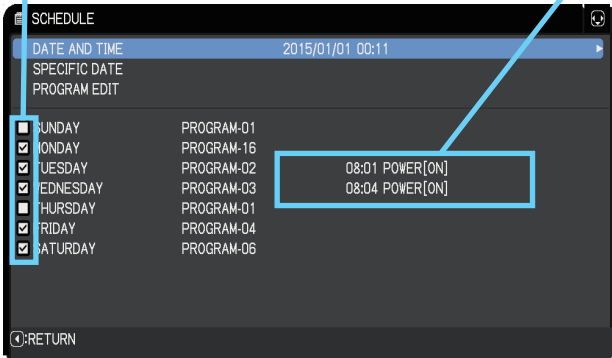
Item	Description								
<p>SCHEDULE</p>	<p>■ How to setup the item</p> <ol style="list-style-type: none"> 1. Use the ▲/▼/◀/▶ cursor buttons to select or adjust. 2. Select OK to finish the settings. <div style="border: 1px solid black; padding: 5px; margin: 10px 0;"> <p>NOTE Refer to the actual on-screen display(OSD) for appropriate operation.</p> </div> <table border="1" style="width: 100%; border-collapse: collapse;"> <thead> <tr> <th style="width: 30%;">Item</th> <th>Description</th> </tr> </thead> <tbody> <tr> <td>DATE & TIME</td> <td>Set the DATE (Year/Month/Date) and Time (24-hour scale).</td> </tr> <tr> <td>SPECIFIC DATE</td> <td>Set specific date from 1 to 10.</td> </tr> <tr> <td>PROGRAM EDIT</td> <td>The TIME and EVENT for Program 1 to 16 can be edited.</td> </tr> </tbody> </table> <p>■ How to activate (DATE AND TIME / SPECIFIC DATE)</p> <p>Place a checkmark in the box.</p>	Item	Description	DATE & TIME	Set the DATE (Year/Month/Date) and Time (24-hour scale).	SPECIFIC DATE	Set specific date from 1 to 10.	PROGRAM EDIT	The TIME and EVENT for Program 1 to 16 can be edited.
	Item	Description							
	DATE & TIME	Set the DATE (Year/Month/Date) and Time (24-hour scale).							
	SPECIFIC DATE	Set specific date from 1 to 10.							
	PROGRAM EDIT	The TIME and EVENT for Program 1 to 16 can be edited.							
<p>Checkmark in the box</p>	<p>Date and first setup info could be seen with the checkmark.</p>								
	<p>1/2 page (Set the DATE (Year/Month/Date) and Time (24-hour scale).)</p>								

(continued on next page)

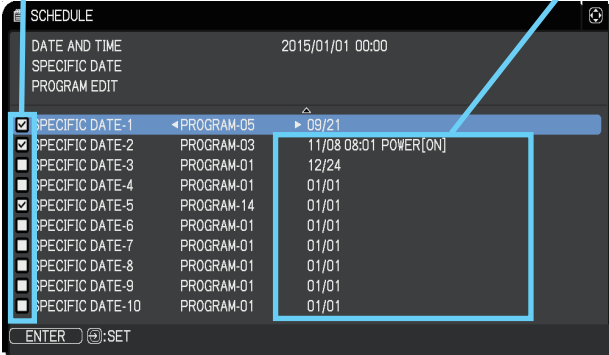
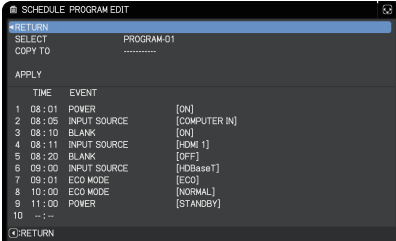
Item	Description
<p>SCHEDULE (continued)</p>	<p>Checkmark in the box</p> <p>Date and first setup info could be seen with the checkmark.</p>  <p>2/2 page (Set specific date from 1 to 10.)</p>
	<p>Press the ▼ cursor button to move from 1/2 page to 2/2 page with the state of selecting "SATURDAY".</p> <p>■ PROGRAM EDIT</p> <p>The TIME and EVENT for Program 1 to 16 can be edited.</p> <ul style="list-style-type: none"> • RETURN Select this to return to the top menu of the SCHEDULE. • SELECT Select from PROGRAM-01 to 16 to edit. Each PROGRAM can be setup up to 20 settings. • COPY TO The selected program (with the settings of TIME and EVENT) can be copied to other program. • APPLY Select this to apply and save all adjustments and settings. 

(continued on next page)

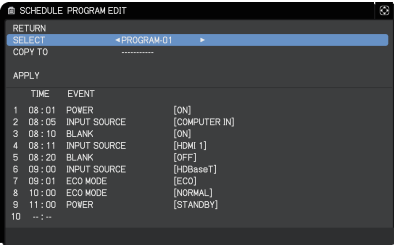
Item	Description
<p>SCHEDULE (continued)</p>	<p>■ How to edit the selected PROGRAM</p> <ol style="list-style-type: none"> 1. Select from 1 to 20 events. Use the ▲/▼ cursor buttons to select. Press ► cursor button to set the TIME and EVENT. 2. Use the ◀/▶ cursor buttons to select. 3. Use the ▲/▼ cursor buttons to adjust.
	<p>EVENT can be selected as listed below.</p> <ul style="list-style-type: none"> ◦ POWER – ON, STANDBY ◦ INPUT SOURCE – "input source" channel ◦ MY IMAGE – IMAGE-1 to 4, IMAGE OFF ◦ MESSENGER – TEXT-1 to 12, TEXT OFF ◦ ECO MODE – NORMAL, ECO ◦ BLANK – ON, OFF
	 <p>The screenshot shows the 'SCHEDULE PROGRAM EDIT' screen. At the top, there are options for 'RETURN', 'SELECT', and 'COPY TO'. Below that is an 'APPLY' section. The main part of the screen is a table with columns for 'TIME' and 'EVENT'. The events listed are: 1 08:01 POWER [ON], 2 08:05 INPUT SOURCE [COMPUTER IN], 3 08:10 BLANK [ON], 4 08:11 INPUT SOURCE [DIMG 1], 5 08:20 BLANK [OFF], 6 09:00 INPUT SOURCE [HDBaseT], 7 09:01 ECO MODE [ECO], 8 10:00 ECO MODE [NORMAL], 9 11:00 POWER [STANDBY], and 10 --:--.</p>
	<ol style="list-style-type: none"> 4. Press ► cursor button to finish the settings. 5. Select APPLY to save the settings.
	<div style="border: 1px solid black; padding: 10px;"> <p>NOTE • Refer to the on-screen display(OSD) for the appropriate operation. • When the STANDBY MODE is set to POWER SAVE, SCHEDULE function (Ex:POWER-ON) at STANBY MODE is not operated.</p> </div>

(continued on next page)

OPTION menu

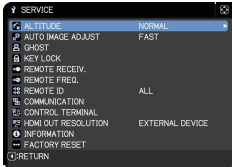
Item	Description
SERVICE	<p>Selecting this item displays the SERVICE menu.</p> <p>Select an item using the ▲/▼ buttons, and press the ► button or the ENTER button on the remote control to execute the item.</p> 
	<p>ALTITUDE</p> <p>Using the ▲/▼ buttons switches the rotation speed of the cooling fans. If the projector is used at an altitude of about 1600 m or higher, select HIGH. Otherwise, select NORMAL. Note that the projector is noisier when the HIGH is selected.</p> <p>HIGH ⇄ NORMAL</p>
	<p>AUTO IMAGE ADJUST</p> <p>Using the ▲/▼ buttons to select one of the mode. When the DISABLE is selected, the automatic adjustment feature is disabled.</p> <p>FINE ⇄ FAST ⇄ DISABLE</p> <p style="text-align: center;">↑—————↑</p> <p>FINE: Finer tuning including H.SIZE adjustment. FAST: Faster tuning, setting H.SIZE to prearranged data for the input signal.</p> <ul style="list-style-type: none"> Depending on conditions, such as input image, signal cable to the projector, environment around the projector, and so on, the automatic adjustment may not work correctly. If this occurs, choose DISABLE to disable the automatic adjustment, and make the adjustment manually.
	<p>GHOST *</p> <p>Adjust the settings using the ▲/▼ buttons to eliminate ghosting.</p>

* LW502/LX602 only

(continued on next page)

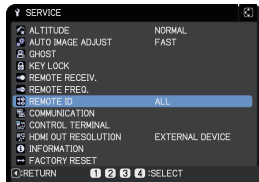

Item	Description
<p>SERVICE (continued)</p>	<p>KEY LOCK</p> <p>(1) Use the ▲/▼ buttons to choose the operations control. CONTROL PANEL ⇔ REMOTE CONTROL</p> <p>(2) Use the ◀/▶ buttons to select ON or OFF. ON ⇔ OFF</p> <p>Selecting ON in Step 2 locks the buttons except STANDBY/ON on the operations control selected in Step 1. Selecting OFF releases the locked buttons on the operations control selected in Step 1.</p> <ul style="list-style-type: none"> • Use this function to prevent tampering or accidental operation. • You cannot disable both options at the same time.
	<p>REMOTE RECEIV. *</p> <p>Switch it using the ◀/▶ button. ON ⇔ OFF</p>
	<p>REMOTE FREQ.</p> <p>(1) Use the ▲/▼ button to change the projector's remote sensor frequency setting (4, 28). 1:NORMAL ⇔ 2:HIGH</p> <p>(2) Use the ◀/▶ button to change the projector's remote sensor on or off. ON ⇔ OFF</p> <p>If the remote control does not function correctly, disable either of them.</p> <ul style="list-style-type: none"> • You cannot disable both options at the same time.
	<p>REMOTE ID</p> <p>This menu is displayed when selecting this item and pressing any of the ID 1-4 buttons of the optional remote control. Use the ▲/▼ buttons on the REMOTE ID menu to select ID and press the ▶ button.</p> <p>ALL ⇔ 1 ⇔ 2 ⇔ 3 ⇔ 4</p> <p>The projector is controlled by the remote control whose ID button is set the same number as this number. When the ALL is selected, the projector is controlled by a remote control irrespective of the ID setting.</p> <ul style="list-style-type: none"> • Available only in optional remote control.

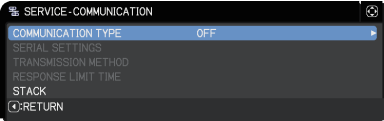

* LW502/LWU502 only
(continued on next page)

Item	Description	
<p>SERVICE (continued)</p>		<p>Selecting this item displays COMMUNICATION menu. In this menu, you can configure the serial communication settings of the projector using the CONTROL port.</p>  <ul style="list-style-type: none"> • Select an item using the cursor buttons ▲/▼. Then pressing the ► button opens the submenu for the setting item you selected. Or, pressing the ◀ button instead of the ► button makes the menu back to the previous one without changing the setup. Each submenu can be operated as described above. • When COMMUNICATION TYPE (📄 below) is set to OFF, the other items except STACK in COMMUNICATION menu are invalid. • For the function of serial communication, refer to the Network Guide.
	<p>COMMUNICATION</p>	<p>COMMUNICATION TYPE Select the communication type for transmission using the CONTROL port.</p> <p>NETWORK BRIDGE (WIRELESS) ⇕ NETWORK BRIDGE (WIRED) ⇕ OFF ←</p> <p>NETWORK BRIDGE: Select this type, if it is required to control an external device as a network terminal, using this projector from the computer. Select WIRELESS or WIRED as your network connection mode. The CONTROL port does not accept RS-232C commands (📄 7. Network Bridge Function in the Network Guide).</p> <p>OFF: Select this mode to receive RS-232C commands using the CONTROL port.</p> <ul style="list-style-type: none"> • OFF is the default setting. • When you select the NETWORK BRIDGE, check the item, TRANSMISSION METHOD (📄 97). • When NETWORK BRIDGE is selected, RS-232C menu of CONTROL TERMINAL cannot be set. The setting of RS-232C is forcibly set to CONTROL.

(continued on next page)

Item	Description	
<p>SERVICE (continued)</p>	<p>COMMUNICATION (continued)</p>	<p>SERIAL SETTINGS Select the serial communication condition for the CONTROL port.</p> <p>BAUD RATE 4800bps ⇔ 9600bps ⇔ 19200bps ⇔ 38400bps </p> <p>PARITY NONE ⇔ ODD ⇔ EVEN </p> <ul style="list-style-type: none"> • The BAUD RATE is fixed to 19200bps and PARITY is fixed NONE when the COMMUNICATION TYPE is set to OFF (🔑 90).
		<p>TRANSMISSION METHOD Select the transmission method for communication by the NETWORK BRIDGE from the CONTROL port.</p> <p>HALF-DUPLEX ⇔ FULL-DUPLEX</p> <p><u>HALF-DUPLEX</u>: This method lets the projector make two way communication, but only one direction, either transmitting or receiving data, is allowed at a time.</p> <p><u>FULL-DUPLEX</u>: This method lets the projector make two way communication, transmitting and receiving data at the same time.</p> <ul style="list-style-type: none"> • HALF-DUPLEX is selected as the default setting. • If you select HALF-DUPLEX, check the setting of the item RESPONSE LIMIT TIME (🔑 92).



(continued on next page)

Item	Description	
<p>SERVICE (continued)</p>	<p>COMMUNICATION (continued)</p>	<p>RESPONSE LIMIT TIME Select the time period to wait for receiving response data from other device communicating by the NETWORK BRIDGE and the HALF-DUPLEX through the CONTROL port.</p> <p>OFF ⇔ 1s ⇔ 2s ⇔ 3s </p> <p><u>OFF</u>: Select this mode if it is not required to check the responses from the device that the projector sends data to. In this mode, the projector can send out data from the computer continuously.</p> <p><u>1s /2s /3s</u>: Select the time period to keep the projector waiting for response from the device that the projector sends data to. While waiting a response, the projector does not send out any data from the CONTROL port.</p> <ul style="list-style-type: none"> • This menu is available only when the NETWORK BRIDGE is selected for the COMMUNICATION TYPE and the HALF-DUPLEX is selected for the TRANSMISSION METHOD (M97). • OFF is selected as the default setting.
		<p>STACK Selecting this item displays the STACK menu. For more information, see the Instant Stack Guide.</p> <ul style="list-style-type: none"> • When STACK MODE is set to MAIN or SUB, the other items in COMMUNICATION menu are invalid. • When STACK MODE is set to MAIN or SUB, RS-232C menu of CONTROL TERMINAL cannot be set. The setting of RS-232C is forcibly set to CONTROL.

(continued on next page)

Item	Description	
<p>SERVICE (continued)</p>	<p>CONTROL TERMINAL *</p>	<p>WIRED NETWORK Selects whether to use LAN or HDBaseT port. LAN ⇔ HDBaseT</p> <div style="border: 1px solid black; border-radius: 10px; padding: 5px;"> <p>NOTE • Only the LAN or HDBaseT port can be used for the connection to the network. Switch it according to the environment.</p> </div> <hr/> <p>RS-232C Selects whether to use CONTROL or HDBaseT port. CONTROL ⇔ HDBaseT</p> <div style="border: 1px solid black; border-radius: 10px; padding: 5px;"> <p>NOTE • Only either CONTROL or HDBaseT port can be used for the RS-232C connection. Switch it according to the environment.</p> </div>
	<p>HDMI OUT RESOLUTION</p>	<p>Selects the device to refer to the resolution information of HDMI output. EXTERNAL DEVICE ⇔ PROJECTOR</p> <ul style="list-style-type: none"> • When EXTERNAL DEVICE is selected, the resolution of the signal input to the projector and signal output from the projector may be restricted by the maximum resolution of the connected device such as projector or monitor. • When PROJECTOR is selected, the image from the device connected to HDMI OUT may not be displayed normally.

* LW502/LWU502 only
(continued on next page)

Item	Description
<p>SERVICE (continued)</p>	<p>INFORMATION</p> <p>Selecting this item displays a dialog titled “INPUT INFORMATION”. It shows the information about the current input.</p> <div style="display: flex; justify-content: space-around; align-items: center;">    </div> <ul style="list-style-type: none"> • The “FRAME LOCK” message on the dialog means the frame lock function is working. • This item cannot be selected for no signal and sync out. • When the MY TEXT DISPLAY is set to ON, the MY TEXT is displayed together with the input information in the INPUT INFORMATION box (107).
	<p>FACTORY RESET</p> <p>Selecting OK using the ► button performs this function. By this function, all menu items are collectively returned to the initial setting. Note that the items LAMP HOURS, FILTER HOURS, LANGUAGE, AUTO BLANK, FILTER MESSAGE, STANDBY MODE, COMMUNICATION, NETWORK and SECURITY settings are not reset.</p> <p>CANCEL ⇌ OK</p>

NETWORK menu

See the **Network Guide** for details of NETWORK operation.

Remember that incorrect network settings on this projector may cause trouble on the network. Consult your network administrator before connecting to an existing access point on your network.

SECURITY menu

SECURITY menu

This projector is equipped with security functions.

From the SECURITY menu, items shown in the table below can be performed.

To use SECURITY menu: User registration is required before using the security functions.

Enter to the SECURITY menu

1. Press the ► button. The ENTER PASSWORD box is displayed.
2. Use the ▲/▼/◀/▶ buttons to enter the registered password. The factory default password is as follows.

LWU502 : 4509 LW502 : 2809 LX602 : 4409

This password can be changed (see below). Move the cursor to the right side of the ENTER PASSWORD box and press the ► button to display the SECURITY menu.

- It is strongly recommended the factory default password to be changed as soon as possible.
- If an incorrect password is input, the ENTER PASSWORD box is displayed again. If incorrect password is input three times, the projector turns off. Afterwards, the projector turns off every time an incorrect password is input.

3. Items shown in the table below can be performed.

If you have forgotten your password

- (1) While the ENTER PASSWORD box is displayed, press and hold the **RESET** button on the remote control for approximately three seconds or press and hold the **INPUT** button for three seconds while pressing the ► button on the projector.
- (2) The 10 digit Inquiring Code is displayed. Contact your dealer with the 10 digit Inquiring Code. Your password is sent after your user registration information is confirmed.

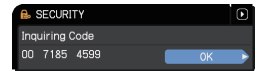
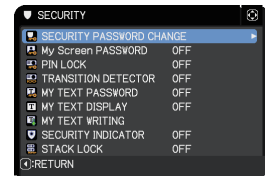
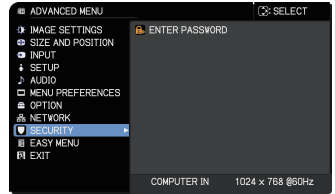

- If there is no key input for approximately 55 seconds while the Inquiring Code is displayed, the menu closes. If necessary, repeat the process from (1).

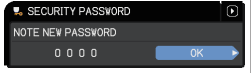
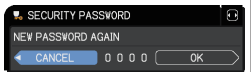

Item	Description
<p>SECURITY PASSWORD CHANGE</p>	<ol style="list-style-type: none"> (1) Use the ▲/▼ buttons on the SECURITY menu to select SECURITY PASSWORD CHANGE and press the ► button to display the ENTER NEW PASSWORD box. (2) Use the ▲/▼/◀/▶ buttons to enter the new password. (3) Move the cursor to the right side of the ENTER NEW PASSWORD box and press the ► button to display the NEW PASSWORD AGAIN box, enter the same password again. (4) Move the cursor to the right side of the NEW PASSWORD AGAIN box and press the ► button and the NOTE NEW PASSWORD box is displayed for about 30 seconds. Make note of the password during this time. Pressing the ENTER button on the remote control or ► button on the projector closes the NOTE NEW PASSWORD box. <ul style="list-style-type: none"> • Do not forget your password.

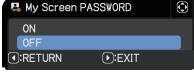

(continued on next page)

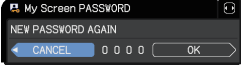
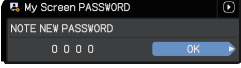
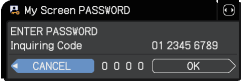
Item	Description
<p style="text-align: center;">My Screen PASSWORD</p>	<p>The My Screen PASSWORD function can be used to prohibit access to the My Screen function and prevent the currently registered My Screen image from being overwritten.</p> <p>1 Turning on the My Screen PASSWORD</p> <p>1-1 Use the ▲/▼ buttons on the SECURITY menu to select My Screen PASSWORD and press the ► button to display the My Screen PASSWORD on/off menu.</p>  <p>1-2 Use the ▲/▼ buttons on the My Screen PASSWORD on/off menu to select ON. The ENTER NEW PASSWORD box (small) is displayed.</p>  <p>1-3 Use the ▲/▼/◀/▶ buttons to enter the password. Move the cursor to the right side of the ENTER NEW PASSWORD box (small) and press the ► button to display the NEW PASSWORD AGAIN box, enter the same PASSWORD again.</p>  <p>1-4 Move the cursor to the right side of the NEW PASSWORD AGAIN box and press the ► button to display the NOTE NEW PASSWORD box for about 30 seconds. Make note of the password during this time. Pressing the ENTER button on the remote control or ► button on the projector returns to My Screen PASSWORD on/off menu.</p>  <p>When a password is set for My Screen:</p> <ul style="list-style-type: none"> • The My Screen registration function (and menu) is unavailable. • The My Screen Lock menu is unavailable. • The START UP setting is locked on My Screen (and the menu is unavailable). <p>Turning the My Screen PASSWORD off allows normal operation of these functions.</p> <ul style="list-style-type: none"> • Do not forget your My Screen PASSWORD. <p>2 Turning off the My Screen PASSWORD</p> <p>2-1 Follow the procedure in 1-1 to display the My Screen PASSWORD on/off menu.</p> <p>2-2 Select OFF to display the ENTER PASSWORD box (large). Enter the registered password and the screen returns to the My Screen PASSWORD on/off menu.</p>  <p>If an incorrect PASSWORD is entered, the menu closes. If necessary, repeat the process from 2-1.</p> <p>3 If you have forgotten your password</p> <p>3-1 Follow the procedure in 1-1 to display the My Screen PASSWORD on/off menu.</p> <p>3-2 Select OFF to display the ENTER PASSWORD box (large). The 10 digit Inquiring Code is displayed inside the box.</p> <p>3-3 Contact your dealer with the 10 digit Inquiring Code. Your password is sent after your user registration information is confirmed.</p>

(continued on next page)

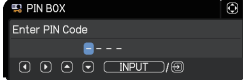
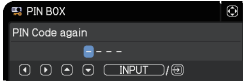
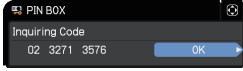

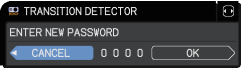
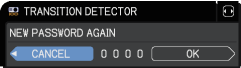
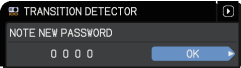
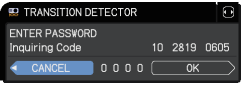

Item	Description
<p>PIN LOCK</p>	<p>PIN LOCK is a function which prevents the projector from being used unless a registered Code is input.</p> <p>1 Turning on the PIN LOCK</p> <p>1-1 Use the ▲/▼ buttons on the SECURITY menu to select PIN LOCK and press the ► button or the ENTER button to display the PIN LOCK on/off menu.</p>  <p>1-2 Use the ▲/▼ buttons on the PIN LOCK on/off menu to select ON and the Enter PIN Code box is displayed.</p>  <p>1-3 Input a four part PIN code using the ▲/▼/◀/▶ or INPUT button. The PIN Code again box appears. Reenter the same PIN code. This completes the PIN code registration.</p>  <ul style="list-style-type: none"> • If there is no key input for about 55 seconds while the Enter PIN Code box or the PIN Code again box is displayed, the menu closes. If necessary, repeat the process from 1-1. <p>Anytime the projector is restarted after AC power is turned off, the Enter PIN Code box is displayed. Enter the registered PIN code. The projector can be used after entering the registered PIN code. If an incorrect PIN code is input, the Enter PIN code box is displayed again. If an incorrect PIN code is input three times, the projector turns off. Afterwards the projector turns off every time an incorrect PIN code is input. The projector also turns off if there is no key input for approximately five minutes while the Enter PIN code box is displayed. This function activates only when the projector is started after AC power is turned off.</p> <ul style="list-style-type: none"> • Do not forget your PIN code. <p>2 Turning off the PIN LOCK</p> <p>2-1 Follow the procedure in 1-1 to display the PIN LOCK on/off menu.</p> <p>2-2 Use the ▲/▼ buttons to select OFF and the Enter PIN Code box is displayed. Enter the registered PIN code to turn the PIN LOCK function off. If an incorrect PIN code is input three times, the projector turns off.</p> <p>3 If you have forgotten your PIN code</p> <p>3-1 While the Enter PIN code box is displayed, press and hold the RESET button for three seconds or press and hold the INPUT button for three seconds while pressing the ► button on the projector. The 10 digit Inquiring Code is displayed.</p> <ul style="list-style-type: none"> • If there is no key input for approximately five minutes while the Inquiring Code is displayed, the projector turns off.  <p>3-2 Contact your dealer with the 10 digit Inquiring Code. Your PIN code is sent after your user registration information is confirmed.</p>

(continued on next page)

Item	Description
<p>TRANSITION DETECTOR</p>	<p>If this function is set to ON and the vertical angle of the projector or the INSTALLATION setting is different from the previous recorded setting, the TRANSITION DETECTOR ON alarm is displayed and the input signal is not displayed.</p> <ul style="list-style-type: none"> • To display the signal again, set this function OFF. • After approximately five minutes of displaying the TRANSITION DETECTOR ON alarm, the lamp turns off. <p>1 Turning on the TRANSITION DETECTOR</p> <p>1-1 Use the ▲/▼ buttons on the SECURITY menu to select TRANSITION DETECTOR and press the ► or the ENTER button to display the TRANSITION DETECTOR on/off menu.</p>  <p>1-2 Use the ▲/▼ buttons on the TRANSITION DETECTOR on/off menu to select ON. Selecting ON saves the setting of the current angle and the INSTALLATION setting. The ENTER NEW PASSWORD box (small) is displayed.</p>  <p>1-3 Use the ▲/▼/◀/▶ buttons to enter a password. Move the cursor to the right side of the ENTER NEW PASSWORD box (small) and press the ► button to display the NEW PASSWORD AGAIN box, enter the same password again.</p>  <p>1-4 Move the cursor to the right side of the NEW PASSWORD AGAIN box and press the ► button to display the NOTE NEW PASSWORD box for about 30 seconds. Make note of the password.</p>  <p>Pressing the ENTER button on the remote control or the ► button on the projector returns to the TRANSITION DETECTOR on/off menu.</p> <ul style="list-style-type: none"> • Do not forget your TRANSITION DETECTOR password. • This function activates only when the projector is started after turning off the AC power. • This feature may not function properly if the projector is not in a stable position when ON is selected. <p>2 Turning off the TRANSITION DETECTOR</p> <p>2-1 Follow the procedure in 1-1 to display the TRANSITION DETECTOR on/off menu.</p> <p>2-2 Select OFF to display the ENTER PASSWORD box (large). Enter the registered password and the screen returns to the TRANSITION DETECTOR on/off menu.</p>  <p>If an incorrect password is entered, the menu closes. If necessary, repeat the process from 2-1.</p> <p>3 If you have forgotten your password</p> <p>3-1 Follow the procedure in 1-1 to display the TRANSITION DETECTOR on/off menu.</p> <p>3-2 Select OFF to display the ENTER PASSWORD box (large). The 10 digit Inquiring Code is displayed inside the box.</p> <p>3-3 Contact your dealer with the 10 digit Inquiring Code. Your password is sent after your user registration information is confirmed.</p>

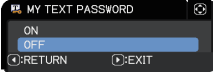
<<TRANSITION DETECTOR ON>>
 The projector has been transferred from previously installed position.
 If you wish to have a square image on screen again, disable Transition Detector on Menu.

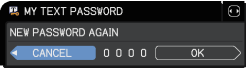
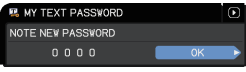
(continued on next page)

Item	Description
<p>MY TEXT PASSWORD</p>	<p>The MY TEXT PASSWORD function can prevent the MY TEXT from being overwritten. When the password is set for the MY TEXT;</p> <ul style="list-style-type: none"> • The MY TEXT DISPLAY menu is unavailable, which can prohibit changing the DISPLAY setting. • The MY TEXT WRITING menu is unavailable, which can prevent the MY TEXT from being overwritten. <p>1 Turning on the MY TEXT PASSWORD</p> <p>1-1 Use the ▲/▼ buttons on the SECURITY menu to select the MY TEXT PASSWORD and press the ► button to display the MY TEXT PASSWORD on/off menu.</p>  <p>1-2 Use the ▲/▼ buttons on the MY TEXT PASSWORD on/off menu to select ON. The ENTER NEW PASSWORD box (small) is displayed.</p>  <p>1-3 Use the ▲/▼/◀/▶ buttons to enter the password. Move the cursor to the right side of the ENTER NEW PASSWORD box (small) and press the ► button to display the NEW PASSWORD AGAIN box, and then enter the same password again.</p>  <p>1-4 Move the cursor to the right side of the NEW PASSWORD AGAIN box and press ► button to display the NOTE NEW PASSWORD box for about 30 seconds. Make note of the password.</p>  <p>Pressing the ENTER button on the remote control or ► button on the projector returns to the MY TEXT PASSWORD on/off menu.</p> <p>2 Turning off the MY TEXT PASSWORD</p> <p>2-1 Follow the procedure in 1-1 to display the MY TEXT PASSWORD on/off menu.</p> <p>2-2 Select OFF to display the ENTER PASSWORD box (large). Enter the registered password and the screen returns to the MY TEXT PASSWORD on/off menu.</p>  <p>If an incorrect password is input, the menu closes. If necessary, repeat the process from 2-1</p> <p>3 If you have forgotten your password</p> <p>3-1 Follow the procedure in 1-1 to display the MY TEXT PASSWORD on/off menu.</p> <p>3-2 Select OFF to display the ENTER PASSWORD box (large). The 10 digit inquiring code is displayed inside the box.</p> <p>3-3 Contact your dealer with the 10 digit inquiring code. Your password is sent after your user registration information is confirmed.</p>

(continued on next page)

Item	Description
<p>MY TEXT DISPLAY</p>	<p>(1) Use the ▲/▼ buttons on the SECURITY menu to select the MY TEXT DISPLAY and press the ► or ENTER button to display the MY TEXT DISPLAY on/off menu.</p> <p>(2) Use the ▲/▼ buttons on the MY TEXT DISPLAY on/off menu to select on or off.</p> <p style="text-align: center;">ON ⇔ OFF</p> <p>When it is set to ON, the MY TEXT is displayed on the START UP screen and the INPUT INFORMATION when the INFORMATION on the SERVICE menu is chosen.</p> <ul style="list-style-type: none"> • This function is available only when the MY TEXT PASSWORD function is set to OFF.
<p>MY TEXT WRITING</p>	<p>(1) Use the ▲/▼ buttons on the SECURITY menu to select the MY TEXT WRITING and press the ► button. The MY TEXT WRITING dialog is displayed.</p> <p>(2) The current MY TEXT is displayed on the first three lines. If not yet written, the lines are blank.</p> <p>Use the ▲/▼/◀/▶ buttons and the ENTER or ↵ button to select and enter characters. To erase one character at one time, press the RESET button or press the ◀ and ↵ button at the same time. If you move the cursor to DELETE or CLEAR ALL on screen and press the ENTER or ↵ button, one or all characters are erased. The MY TEXT can be input up to 24 characters on each line.</p> <p>(3) To change an already inserted character, press the ▲/▼ button to move the cursor to one of the first three lines, and use the ◀/▶ buttons to move the cursor on the character to be changed.</p> <p>After pressing the ENTER or ↵ button, the character is selected. Then, follow the same procedure as described at the item (2) above.</p> <p>(4) To finish entering text, move the cursor to the OK on screen and press the ►, ENTER or ↵ button. To revert to the previous MY TEXT without saving changes, move the cursor to the CANCEL on screen and press the ◀, ENTER or ↵ button.</p> <ul style="list-style-type: none"> • The MY TEXT WRITING function is available only when the MY TEXT PASSWORD function is set to OFF.

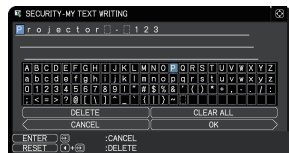
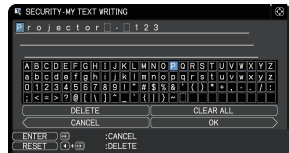
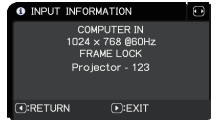

(continued on next page)

SECURITY menu

Item	Description
<p>SECURITY INDICATOR</p>	<p>Selecting this item displays the SECURITY INDICATOR dialog. Use the ▲/▼ buttons to select ON or OFF.</p> <p>ON ⇔ OFF</p> <p>When ON is selected while PIN LOCK or TRANSITION DETECTOR is ON, the SECURITY indicator blinks in yellow in the standby mode (📖 98, 99).</p>
<p>STACK LOCK</p>	<p>Selecting this item displays the STACK LOCK dialog. For more information, see the Instant Stack Guide.</p>

Maintenance

Replacing the lamp

A lamp has finite product life. Using the lamp for long periods of time could cause the pictures to darken or the color tone to turn poor. Each lamp has a different lifetime, and some may burst or burn out soon after you start using them. New lamp preparation and early replacement are recommended. To prepare a new lamp, contact your dealer and indicate the lamp type number.

Type number : 003-005852-01 (DT01935)

Replacing the lamp

1. Turn the projector off, and unplug the power cord.
 - Allow the projector to cool for at least 45 minutes.
2. Prepare a new lamp. If the projector is mounted with specified mounting accessories, or if the lamp has broken, also ask the dealer to replace the lamp.

If replacing the lamp by yourself, complete the following procedure.

3. Loosen the screw (marked by arrow) of the lamp cover and then slide down and lift the lamp cover to remove it.
4. Loosen the three screws (marked by arrow) of the lamp, and slowly pull the lamp out by the handles. Never loosen any other screws.
5. Insert the new lamp, and firmly retighten the three screws of the lamp loosened in the previous step to lock it in place.
6. While putting the interlocking parts of the lamp cover and the projector together, slide the lamp cover back in place. Firmly fasten the screw of the lamp cover.
7. Turn the projector on and reset the lamp hours using the LAMP HOURS item in the SETUP menu.

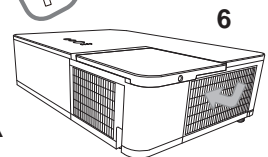
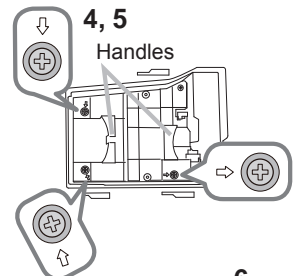
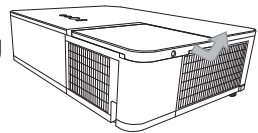
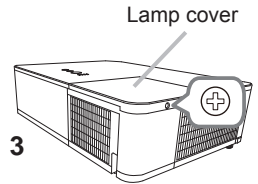

- (1) Press the **MENU** button to display a menu.
- (2) Point at the **ADVANCED MENU** in the menu using the **▼/▲** button, then press the **▶** button.
- (3) Point at the **SETUP** in the left column of the menu using the **▼/▲** button, then press the **▶** button.
- (4) Point at the **LAMP & FILTER** using the **▼/▲** button, then press the **▶** button.
- (5) Point at the **LAMP HOURS** using the **▼/▲** button, then press the **▶** button. A dialog appears.
- (6) Press the **▶** button to select "OK" on the dialog. The lamp time is reset.

⚠ CAUTION ▶ Do not touch the interior of the projector, while the lamp is removed.

NOTE • Reset the lamp hours only when you have replaced the lamp, for a suitable indication about the lamp.

Replacing the lamp (continued)

Lamp warning

 **HIGH VOLTAGE**  **HIGH TEMPERATURE**  **HIGH PRESSURE**

⚠ WARNING ▶ The projector uses a high-pressure mercury glass lamp. The lamp can break with a loud bang, or burn out, if jolted or scratched, handled while hot, or worn over time. Note that each lamp has a different lifetime, and some may burst or burn out soon after you start using them. In addition, if the bulb bursts, shards of glass can fly into the lamp housing, and gas containing mercury and dust containing fine particles of glass can escape from the projector's vent holes.

▶ **About disposal of a lamp:** This projector contains a mercury lamp; do not put it in a trash. Dispose of it in accordance with environmental laws.

- For lamp recycling, go to www.lamprecycle.org (in the US).
- For projector disposal, consult your local government agency or www.eiae.org (in the US) or www.epsc.ca (in Canada).

For more information, consult your dealer.



Disconnect the plug from the power outlet

- If the lamp breaks (it makes a loud bang), unplug the power cord from the outlet, and request a replacement lamp from your local dealer. Note that shards of glass could damage the projector's internals, or cause injury during handling. Do not try to clean the projector or replace the lamp yourself.
- If the lamp should break (it makes a loud bang), ventilate the room well, and make sure not to inhale the gas or fine particles that come out from the projector's vent holes, and not to get them into your eyes or mouth.
- Before replacing the lamp, turn the projector off and unplug the power cord, then wait at least 45 minutes for the lamp to cool sufficiently. Handling the lamp while hot can cause burns, as well as damaging the lamp.



- Never unscrew except the appointed (marked by an arrow) screws.
- Do not open the lamp cover while the projector is suspended from a ceiling. This is dangerous because shards fall out when the cover is open after a lamp's bulb has broken. Working in high places is dangerous, so ask your local dealer to have the lamp replaced even if the bulb is not broken.
- Do not use the projector with the lamp cover removed. During lamp replacement, make sure that the screws are screwed in firmly. Loose screws could result in damage or injury.



- Use only the lamp of the specified type. Use of a lamp that does not meet the lamp specifications for this model could cause a fire, damage or shorten the life of this projector.
- If the lamp breaks soon after the first time it is used, there may be electrical problems elsewhere besides the lamp. If this happens, consult your local dealer or a service representative.
- Handle with care: jolting or scratching could cause the lamp bulb to burst during use.
- Using the lamp for long periods of time, could cause it to darken, not to light up or to burst. When the pictures appear dark, or when the color tone is poor, replace the lamp as soon as possible. Do not use old (used) lamps; this causes breakage.

Cleaning and replacing the air filter

Check and clean the air filter periodically. When the indicators or a message prompts you to clean the air filter, replace the filter as soon as possible.

The extra air filter is attached to inner side of the filter cover. If one of the filters is damaged or heavily soiled, replace whole filter set with a new one.

Request a filter set with the following type number from your dealer when purchasing a new one.

Type number : 003-005853-01 (UX41161)

1. Turn the projector off, and unplug the power cord. Allow the projector to sufficiently cool down.
2. Use a vacuum cleaner on and around the filter cover.
3. Pick and pull up the filter cover knobs to take it off.
4. Press up slightly on the bottom side knobs to unlock the bottom side of the filter unit. Pull the center knob to take the filter unit off.
5. Use a vacuum cleaner to clean the filter vent of the projector and the outer side of the filter unit.
6. Use a vacuum cleaner to clean the inner side of each part of the filter unit to clean them up. If the filters are damaged or heavily soiled, replace them with the new ones.
7. Put the filter unit back in an upright state into the projector.
8. Put the filter cover back into the place.

(continued on next page)

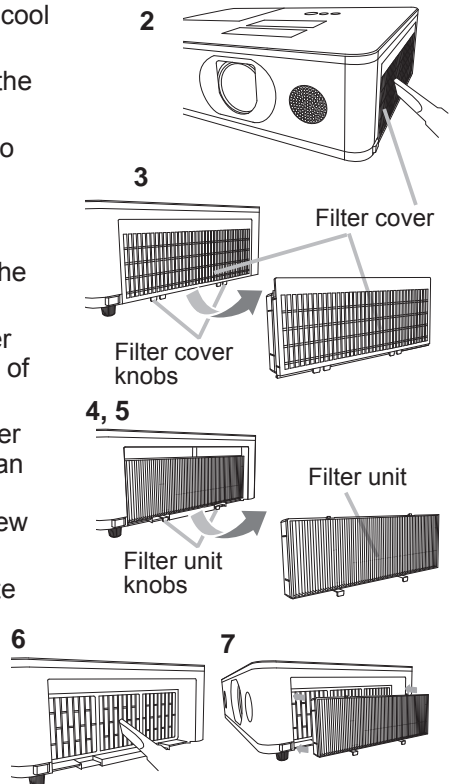

Cleaning and replacing the air filter (continued)

9. Turn the projector on and reset the filter hours using the FILTER HOURS item in the EASY MENU.
- (1) Press the **MENU** button to display a menu.
 - (2) Point at the FILTER HOURS using the ▲/▼ cursor buttons, then press the ► cursor (or the **ENTER** / the **RESET**) button. A dialog appears.
 - (3) Press the ► cursor button to select the OK on the dialog. It performs resetting the filter hours.

⚠ WARNING ► Before taking care of the air filter, make sure the power cord is not plugged in, then allow the projector to cool sufficiently.

► Use only the air filter of the specified type. Do not use the projector without the air filter or the filter cover. It could result in a fire or malfunction to the projector.

► Clean the air filter periodically. If the air filter becomes clogged by dust, internal temperatures rise and could cause a fire, a burn or malfunction to the projector.

NOTE • Reset the filter hours only when you have cleaned or replaced the air filter, for a suitable indication about the air filter.

• The projector may display the message such as the “CHECK THE AIR FLOW” or turn off the projector, to prevent the internal heat level rising.

Replacing the internal clock battery

Installing the battery may be required. (Event Scheduling in the User's Manual - Network Guide) A battery is not contained at the time of factory shipment. Replace a battery according to the following procedure.

1. Turn the projector off, and unplug the power cord. Allow the projector to cool sufficiently.
2. After making sure that the projector has cooled adequately, slowly turn over the projector, so that the bottom is facing up.
3. Turn the battery cover fully in the direction indicated **OPEN** using a coin, and pick the cover up to remove it.
4. Pry up the battery using a flathead screwdriver to take it out. Do not use any metal tools. While prying it up, put a finger lightly on the battery as it may pop out of the holder.
5. Replace the battery with a new MAXELL or HITACHI MAXELL, Part No. **CR2032** or **CR2032H**. Slide the battery in under the plastic claw, and push it into the holder until it clicks.
6. Replace the battery cover in place, then turn it in the direction indicated **CLOSE** using a coin.

Battery Cover

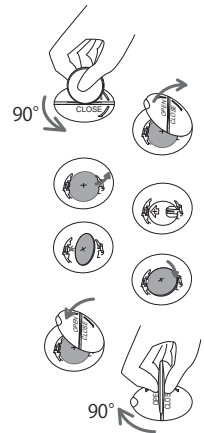
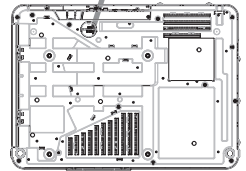

⚠WARNING ▶ Always handle the batteries with care and use them only as directed. The battery may explode if mistreated. Do not recharge, disassemble or dispose of using fire. Improper use may result in cracking or leakage, which could result in fire, injury and/or pollution of the surrounding environment.

- Use only the batteries specified.
- Make sure the plus and minus terminals are correctly aligned when loading a battery.
- Keep a battery away from children and pets. If swallowed consult a physician immediately for emergency treatment.
- Do not short circuit or solder a battery.
- Do not place a battery in a fire or water. Keep batteries in a dark, cool and dry place.
- If you observe battery leakage, wipe out the leakage and then replace a battery. If the leakage adheres to your body or clothes, rinse well with water immediately.
- Obey the local laws on disposing a battery.

Other care

Inside of the projector

To ensure the safe use of your projector, have it cleaned and inspected by your dealer every year.

Caring for the lens

If the lens is flawed, soiled or fogged, it could cause deterioration of display quality. Take care of the lens, being cautious of handling.

1. Turn the projector off, and unplug the power cord. Allow the projector to cool sufficiently.
2. After making sure that the projector is cool adequately, lightly wipe the lens with a commercially available lens-cleaning wipe. Do not touch the lens directly with your hand.

Caring for the cabinet and remote control

Incorrect care could have adverse influence such as discoloration, peeling paint, etc.

1. Turn the projector off, and unplug the power cord. Allow the projector to cool sufficiently.
2. After making sure that the projector is cool adequately, lightly wipe with gauze or a soft cloth.
If the projector is extremely dirty, dip a soft cloth in water or a neutral cleaner diluted in water, and wipe lightly after wringing well. Then, wipe lightly with a soft, dry cloth.

⚠ WARNING ▶ Make sure the power cord is not plugged in, and allow the projector to cool sufficiently. The high temperature state of the projector could cause a burn and/or malfunction to the projector.

- ▶ Do not clean or service the inside of the projector. Doing it is so dangerous.
- ▶ Avoid wetting the projector or inserting liquids in the projector. It could result in a fire, an electric shock, and/or malfunction to the projector.
- Do not put anything containing water, cleaners or chemicals near the projector.
- Do not use aerosols or sprays.

⚠ CAUTION ▶ Incorrect care of the projector could cause not only an injury but adverse influence such as discoloration, peeling paint, etc.

- ▶ Do not use cleaners or chemicals other than those specified in this manual.
- ▶ Do not polish or wipe with hard objects.

NOTICE ▶ Do not directly touch the lens surface with hands.

Troubleshooting

If an abnormal operation should occur, stop using the projector immediately.

⚠ WARNING ▶ Never use the projector if abnormal operations such as smoke, strange odor, excessive sound, damaged casing or elements or cables, penetration of liquids or foreign matter, and so on should occur. In such cases, immediately disconnect the power plug from the power outlet. After making sure that the smoke or odor has stopped, contact to your dealer or service company.



If a problem occurs with the projector, the following checks and measures are recommended before requesting repair.

If this does not resolve the problem, contact your dealer or service company.

They tell you what warranty condition is applied.



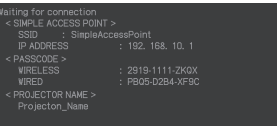

Related messages

When some messages appear, check and deal with it according to the following table. Although these messages automatically disappear after several minutes, they reappear when the power is turned on.

Message	Description
	<p>There is no input signal. Confirm the signal input connection, and the status of the signal source.</p>
	<p>Projector is waiting for an image file. Check the hardware connection, settings on the projector and network-related settings. The computer-Projector network connection might be disconnected. Re-connect them.</p>
	





(continued on next page)

Related messages (continued)

Message	Description
	<p>The horizontal or vertical frequency of the input signal is not within the specified range. Confirm the specs for your projector or the signal source specs.</p>
	<p>An improper signal is input. Confirm the specs for your projector or the signal source specs.</p>
	<p>The internal temperature is rising. Turn the power off, and allow the projector to cool down at least 20 minutes. After having confirmed the following items, turn the power ON again.</p> <ul style="list-style-type: none"> • Is there blockage of the air passage aperture? • Is the air filter dirty? • Use the unit within the usage temperature parameters (0°C to 35°C or 40°C ( Setup Guide)). • Is the setting for ALTITUDE appropriate? • Is the exhaust air (hot/cold) from peripheral equipment blowing against the ventilation opening of projector? <p>For details of ALTITUDE, refer to ALTITUDE of SERVICE in the OPTION menu ( 88). If the projector is used with a wrong setting, it may cause damage to the projector itself or the parts inside.</p>

(continued on next page)

Related messages (continued)



Message	Description
	<p>A note of precaution when cleaning the air filter. Turn the power off immediately, and clean or change the air filter referring to the Cleaning and replacing the air filter section of this manual. After you have cleaned or changed the air filter, reset the filter timer ( 70, 106).</p>
	<p>The button operation is not available. Check the button you want to use ( 7).</p>

















Regarding the indicator lamps

Regarding the indicator lamps

The indicators may differ from this manual, check and deal with it according to the following table.

The indicators are described as below.

		
Lit Steady light	Blinking	Off

Indicator Status	Description
<ul style="list-style-type: none">  SECURITY  LAMP  TEMP  POWER Orange 	<p>The projector is in a standby state. Refer to the section "Power on/off".</p>
<ul style="list-style-type: none">  SECURITY  LAMP  TEMP  POWER Green 	<p>The projector is warming up. Wait for the projector to warm up.</p>
<ul style="list-style-type: none">  SECURITY  LAMP  TEMP  POWER Green 	<p>The projector is in an on state. Ordinary operations may be performed.</p>
<ul style="list-style-type: none">  SECURITY  LAMP  TEMP  POWER Orange 	<p>The projector is cooling down. Wait for the projector to cool down.</p>

(continued on next page)

Regarding the indicator lamps (continued)

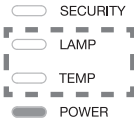
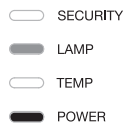
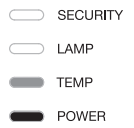
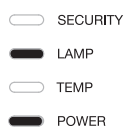
Indicator Status	Description
 <p>discretionary Red</p>	<p>The projector is cooling down. A certain error has been detected. Wait until POWER indicator finishes blinking, and then perform the proper measure using the item descriptions below.</p>
 <p>Red Red</p>	<p>The lamp cover has not been properly fixed. Turn the power off, and allow the projector to cool down at least 45 minutes. After the projector has sufficiently cooled down, confirm the attachment state of the lamp cover. After performing any needed maintenance, turn the power on again. If the same indication is displayed after the remedy, contact your dealer or service company.</p>
 <p>Red Red</p>	<p>The cooling fan is not operating. Turn the power off, and allow the projector to cool down at least 20 minutes. After the projector has sufficiently cooled down, confirm that no foreign matter has become caught in the fan, and so on, and then turn the power on again. If the same indication is displayed after the remedy, contact your dealer or service company.</p>
 <p>Red Red</p>	<p>The lamp does not light, and there is a possibility that interior portion has become heated. Otherwise, AC power supply is unstable (ACBLK). Turn the power off, and allow the projector to cool down at least 20 minutes. After the projector has sufficiently cooled down, confirm the following items, and then turn the power on again.</p> <ul style="list-style-type: none"> • Is there blockage of the air passage aperture? • Is the air filter dirty? • Use the unit within the temperature range. NORMAL MODE: 0 to 35°C ECO MODE: 0 to 40°C <p>If the same indication is displayed after the remedy, change the lamp referring to the section Replacing the lamp.</p>

(continued on next page)

Regarding the indicator lamps

Regarding the indicator lamps (continued)

Indicator Status	Description
<p>○ SECURITY</p> <p>○ LAMP</p> <p>■ TEMP Red</p> <p>■ POWER Red</p>	<p>The interior portion has become heated.</p> <p>Turn the power off, and allow the projector to cool down at least 20 minutes. After the projector has sufficiently cooled down, confirm the following items, and then turn the power on again.</p> <ul style="list-style-type: none"> • Is there blockage of the air passage aperture? • Is the air filter dirty? • Use the unit within the temperature range. NORMAL MODE: 0 to 35°C ECO MODE: 0 to 40°C • Is the setting for ALTITUDE appropriate? • Is the exhaust air (hot/cold) from peripheral equipment blowing against the ventilation opening of projector? <p>For details on ALTITUDE, refer to ALTITUDE of SERVICE in the OPTION menu. If the projector is used with a wrong setting, it may cause damage to the projector itself or the parts inside.</p>
<p>○ SECURITY</p> <p>■ LAMP Red</p> <p>■ TEMP Red</p> <p>○ POWER Blinking at the same time</p>	<p>It is time to clean the air filter.</p> <p>Turn the power off immediately, and clean or change the air filter referring to the section Cleaning and replacing the air filter. After cleaning or changing the air filter, reset the filter timer. Restart the projector.</p>
<p>○ SECURITY</p> <p>■ LAMP Red</p> <p>○ TEMP</p> <p>○ POWER</p>	<p>This is a Lamp Error.</p> <p>Lamp is turned off.</p> <p>Turn the power off, and allow the projector to cool down at least 45 minutes. Restart the projector.</p> <p>If the same indication is displayed after the remedy, contact your dealer or service company.</p>

(continued on next page)

Regarding the indicator lamps (continued)

Indicator Status	Description
<p>Yellow</p>	<p>PIN LOCK function is active. See SECURITY menu > PIN LOCK (📖 98)</p> <p>If the same indication is displayed after the remedy, contact your dealer or service company.</p>
<p>Blinking alternately</p> <p>Red</p> <p>Green</p>	<p>There is a possibility that the interior portion has become overcooled.</p> <ul style="list-style-type: none"> • Use the unit within the temperature range. NORMAL MODE: 0 to 35°C ECO MODE: 0 to 40°C
	<p>AC BLACKOUT error has occurred.</p>

(continued on next page)

Regarding the indicator lamps (continued)

NOTE • When the interior portion has become overheated, for safety purposes, the projector is automatically shut down, and the indicator lamps may also be turned off. In such a case, disconnect the power cord, and wait at least 45 minutes. After the projector has sufficiently cooled down, confirm the attachment state of the lamp and lamp cover, and turn the power on again.

For the **SECURITY** indicator, see SECURITY INDICATOR in the SECURITY menu (102).

Resetting all settings

When it is difficult to correct wrong settings, the FACTORY RESET function of SERVICE item in OPTION menu (94) can reset all settings (except settings such as LANGUAGE, AUTO BLANK, LAMP HOURS, FILTER HOURS, FILTER MESSAGE, STANDBY MODE, COMMUNICATION, SECURITY and NETWORK) to the factory default.

Issues that may be easy to be mistaken for machine defects

An issue may be confused with a machine defect, check and deal with it according to the following table.

Issue	Cases not involving a machine defect	Reference page
Power does not come on.	<p>The electrical power cord is not plugged in. Correctly connect the power cord.</p>	26
	<p>The main power source has been interrupted during operation such as by a power outage (blackout), etc. Disconnect the power plug from the power outlet, and allow the projector to cool down at least 10 minutes, then turn the power on again.</p>	26
	<p>Either there is no lamp and/or lamp cover, or either of these has not been properly fixed. Turn the power off and disconnect the power plug from the power outlet, and allow the projector to cool down at least 45 minutes. After the projector has sufficiently cooled down, confirm the attachment state of the lamp and lamp cover, and then turn the power on again.</p>	103
Neither sounds nor pictures are output.	<p>The signal cables are not correctly connected. Correctly connect the connection cables.</p>	12 ~ 21
	<p>Signal source does not correctly work. Correctly set up the signal source device by referring to the manual of the source device.</p>	-
	<p>The input changeover settings are mismatched. Select the input signal, and correct the settings.</p>	33
	<p>The BLANK function for pictures and the MUTE function for sounds are working. AV MUTE may be active. Refer to the item “Sound does not come out” and “No pictures are displayed” on the next page to turn off the MUTE and BLANK functions.</p>	32

(continued on next page)

Troubleshooting

Issues that may be easy to be mistaken for machine defects (continued)

Issue	Cases not involving a machine defect	Reference page
Sound does not come out.	<p>The signal cables are not correctly connected. Correctly connect the audio cables.</p>	12 ~ 21
	<p>The volume is adjusted to an extremely low level. Adjust the volume to a higher level using the menu function or the remote control.</p>	32, 75
	<p>The AUDIO SOURCE/SPEAKER setting is not correct. Correctly set the AUDIO SOURCE/SPEAKER in AUDIO menu.</p>	75
	<p>The Sound button (♪) or checkbox is disabled. If you have selected LAN, remove the checkmark from the Sound checkbox in the Option menu of LiveViewer.</p>	-
	<p>The MUTE function is working. Restore the sound pressing MUTE or VOLUME +/- button on the remote control.</p>	32
No pictures are displayed.	<p>The signal cables are not correctly connected. Correctly connect the connection cables.</p>	12 ~ 21
	<p>The brightness is adjusted to an extremely low level. Adjust BRIGHTNESS to a higher level using the menu function.</p>	56
	<p>The computer cannot detect the projector as a plug and play monitor. Make sure that the computer can detect a plug and play monitor using another plug and play monitor.</p>	12
	<p>The lens shutter is closed. Press SHUTTER button (MY BUTTON) on the remote control.</p>	84
	<p>The BLANK screen is displayed. Press BLANK button on the remote control.</p>	46

(continued on next page)

Issues that may be easy to be mistaken for machine defects (continued)

Issue	Cases not involving a machine defect	Reference page
The remote control does not work.	The batteries in the remote control are near the end. Replace the batteries.	27
Video screen display freezes.	The FREEZE function is working. Press FREEZE button to restore the screen to normal.	46
Colors have a faded-out appearance, or color tone is poor.	Color settings are not correctly adjusted. Perform picture adjustments by changing the COLOR TEMP, COLOR and/or TINT settings, using the menu functions.	56, 58
	COLOR SPACE setting is not suitable. Change the COLOR SPACE setting to AUTO, RGB, SMPTE240, REC709 or REC601.	63
Pictures appear dark.	The brightness and/or contrast are adjusted to an extremely low level. Adjust BRIGHTNESS and/or CONTRAST settings to a higher level using the menu function.	56
	The projector is operating in Eco mode. Set ECO MODE in the LAMP & FILTER menu to NORMAL.	69
	The lamp is approaching the end of its product lifetime. Replace the lamp.	103
	Dimming Level of Blending function is working. Set Dimming Level to a higher level or set Blending - Mode to OFF.	41, 44
Pictures appear blurry.	The lens cover is attached. Remove the lens cover.	-
	Either the focus and/or horizontal phase settings are not properly adjusted. Adjust the focus using the focus ring, and/or H PHASE using the menu function.	35, 62

(continued on next page)

Issues that may be easy to be mistaken for machine defects (continued)

Issue	Cases not involving a machine defect	Reference page
Pictures appear blurry. (continued)	The lens is dirty or misty. Clean the lens referring to the section Caring for the lens.	108
Some kind of image degradation such as flickering or stripes appear on screen.	When the projector is operating in Eco mode, flickering may appear on screen. Set ECO MODE in the LAMP & FILTER menu to NORMAL.	69
	The OVER SCAN ratio is too big. Adjust OVER SCAN in the SIZE AND POSITION menu smaller.	61
	Excessive VIDEO NR. Change the setting of VIDEO NR in the INPUT menu.	63
	The FRAME LOCK function cannot work on the current input signal. Set FRAME LOCK in the INPUT menu to OFF.	65
RS-232C does not work on control terminal.	The POWER SAVE function is working. Select NORMAL for STANDBY MODE item in the SETUP menu.	72
	RS-232C is set to HDBaseT. Select CONTROL for RS-232C item in the OPTION menu.	93
	The COMMUNICATION TYPE for the CONTROL port is set to NETWORK BRIDGE. Select OFF for COMMUNICATION TYPE item in the OPTION - SERVICE - COMMUNICATION menu.	90
Network does not work.	The POWER SAVE function is working. Select NORMAL for STANDBY MODE item in the SETUP menu.	72
	The same network address is set for both wireless and wired LAN. Change the network address setting for wireless or wired LAN.	-

(continued on next page)

Issues that may be easy to be mistaken for machine defects (continued)

Issue	Cases not involving a machine defect	Reference page
Displayed image is partially dark.	Blending Region is set. Set all Blending Region to OFF or set Blending – Mode to OFF.	41
ECO MODE setting cannot be changed.	Blending - Mode is set to MANUAL. Set Blending – Mode to OFF.	41
The IR and RS-232C does not work on HDBaseT™ connection.	The POWER SAVE function is working. Select NORMAL for STANDBY MODE item in the SETUP menu.	72
RS-232C does not work on HDBaseT connection.	RS-232C is set to CONTROL. Select HDBaseT for RS-232C item in the OPTION menu.	93
HDBaseT connection does not work.	The POWER SAVE function is working. Select NORMAL for STANDBY MODE item in the SETUP menu.	72
	The connected equipment may not be supported by HDBaseT. Refer to User's manual (detailed) for connection.	13
IR and LAN does not work via HDBaseT.	Check if the IR setting is OFF under HDBaseT. EASY MENU > ADVANCED MENU > OPTION > SERVICE > REMOTE RECEIV.	89
	Check if the LAN setting is HDBaseT. EASY MENU > ADVANCED MENU > OPTION > SERVICE > CONTROL TERMINAL > WIRED NETWORK	–
LAN does not work, if LAN is connected to the projector while having an input signal from HDBaseT.	Check if the LAN setting is HDBaseT. EASY MENU > ADVANCED MENU > OPTION > SERVICE > CONTROL TERMINAL > WIRED NETWORK	–
	This projector is compatible with 100BASE-T only. Check the specification of the connected equipment.	–
	If the LAN cable is connected with the hub, try to change the connected port at the hub.	–
	If the LAN cable is connected directly to the computer, try to connect to other computer.	–

(continued on next page)

Issues that may be easy to be mistaken for machine defects (continued)

Issue	Cases not involving a machine defect	Reference page
No image is displayed via HDBaseT.	Check the LAN cable if it is CAT5e certified or higher.	–
	Try to change the LAN cable.	–
	If the LAN cable is connected with more than three extension connectors, the transmission of 100 meters may fail.	–
	Check if the extension connector is compatible with CAT5e. All LAN cable and extension connector connected with HDBaseT port must be CAT5e certified.	–
NETWORK BRIDGE function does not work.	The NETWORK BRIDGE function is turned off. Select NETWORK BRIDGE for COMMUNICATION TYPE item in the OPTION - SERVICE - COMMUNICATION menu.	90
Schedule function does not work.	The POWER SAVE function is working. Select NORMAL for STANDBY MODE item in the SETUP menu.	72
	The internal clock has been reset. Once you turn off the projector in the POWER SAVE mode or the AC power, the current date and time setting is reset. Check the SCHEDULE setting for WIRELESS SETUP or WIRED SETUP in the NETWORK menu.	–
STANDBY OUTPUT (AUDIO OUT, HDMI OUT, MONITOR OUT) does not work with standby mode.	Check if POWER SAVE is set in SETUP - STANDBY MODE. Set NORMAL in the menu above. If the signal is not output yet, check if a desirable item is set in SETUP - STANDBY OUTPUT.	72

(continued on next page)

Issues that may be easy to be mistaken for machine defects (continued)

Issue	Cases not involving a machine defect	Reference page
The signal from HDMI OUT is not output in the external device.	<p>Check if PROJECTOR is set in OPTION - SERVICE - HDMI OUT RESOLUTION.</p> <p>Set EXTERNAL DEVICE in the menu above.</p> <p>If the signal is not output yet, check the supported resolution of the external device.</p>	93
The signal from HDMI OUT is not output in other connected projectors.	<p>Check if EXTERNAL DEVICE is set in OPTION - SERVICE - HDMI OUT RESOLUTION.</p> <p>Set PROJECTOR in the menu above.</p>	93
<p>When the projector is connected to the network, it powers off and on as described below.</p> <p>Powers off ←</p> <p>↓</p> <p>POWER</p> <p>indicator blinks in orange a few times</p> <p>↓</p> <p>Goes into standby mode</p>	<p>Disconnect the LAN cable and check that the projector is working properly.</p> <p>If this issue occurs after connecting to the network, there may be a loop between two Ethernet switching hubs within the network.</p> <ul style="list-style-type: none"> - Two or more Ethernet switching hubs are in a network. - Two of the hubs are doubly connected by LAN cables. - This double connection forms a loop between the two hubs. <p>Such a loop may have an adverse effect on the projector as well as the other network devices.</p> <p>Check the network connection and remove the loop by disconnecting the LAN cables such that there is only one connecting cable between two hubs.</p>	-

NOTE • Although bright spots or dark spots may appear on the screen, this is a unique characteristic of liquid crystal displays, and it does not constitute or imply a machine defect.

Specifications

See the **Specifications** in the **Setup Guide** which is a book.

End User License Agreement for the Projector Software

- Software in the projector consists of the plural number of independent software modules and there exist our copyright and/or third party copyrights for each of such software modules.
- Read “End User License Agreement for the Projector Software” which is separated document.

Corporate offices

USA – Cypress
ph: 714-236-8610
Canada – Kitchener
ph: 519-744-8005

Consultant offices

Italy
ph: +39 (0) 2 9902 1161

Worldwide offices

Australia
ph: +61 (0) 7 3624 4888
Brazil
ph: +55 (11) 2548 4753
China (Beijing)
ph: +86 10 6561 0240
China (Shanghai)
ph: +86 21 6278 7708
Eastern Europe and
Russian Federation
ph: +36 (0) 1 47 48 100

France
ph: +33 (0) 1 41 21 44 04
Germany
ph: +49 2161 664540
India
ph: +91 (080) 6708 9999
Japan
ph: 81-3-3599-7481
Korea (Seoul)
ph: +82 2 702 1601

Republic of South Africa
ph: +27 (0)11 510 0094
Singapore
ph: +65 6877-8737
Spain
ph: + 34 91 633 9990
United Arab Emirates
ph: +971 4 3206688
United Kingdom
ph: +44 118 977 8000



For the most current technical documentation,
please visit www.christiedigital.com

CHRISTIE®