



205 Westwood Ave, Long Branch, NJ 07740
Phone: 866-94 BOARDS (26273) / (732)-222-1511
Fax: (732)-222-7088 | E-mail: sales@touchboards.com

User Manual

020-000839-01

FHQ552-T and FHQ842-T LCD Touch Panels



CHRISTIE®

User Manual

020-000839-01

FHQ552-T and FHQ842-T LCD Touch Panels

NOTICES

COPYRIGHT AND TRADEMARKS

Copyright © 2015 Christie Digital Systems USA, Inc. All rights reserved.

All brand names and product names are trademarks, registered trademarks or trade names of their respective holders.

GENERAL

Every effort has been made to ensure accuracy, however in some cases changes in the products or availability could occur which may not be reflected in this document. Christie reserves the right to make changes to specifications at any time without notice. Performance specifications are typical, but may vary depending on conditions beyond Christie's control such as maintenance of the product in proper working conditions. Performance specifications are based on information available at the time of printing. Christie makes no warranty of any kind with regard to this material, including, but not limited to, implied warranties of fitness for a particular purpose. Christie will not be liable for errors contained herein or for incidental or consequential damages in connection with the performance or use of this material. Canadian manufacturing facility is ISO 9001 and 14001 certified.

WARRANTY

Products are warranted under Christie's standard limited warranty, the complete details of which are available by contacting your Christie dealer or Christie. In addition to the other limitations that may be specified in Christie's standard limited warranty and, to the extent relevant or applicable to your product, the warranty does not cover:

- a) Problems or damage occurring during shipment, in either direction.
- b) Projector lamps (See Christie's separate lamp program policy).
- c) Problems or damage caused by use of a projector lamp beyond the recommended lamp life, or use of a lamp other than a Christie lamp supplied by Christie or an authorized distributor of Christie lamps.
- d) Problems or damage caused by combination of a product with non-Christie equipment, such as distribution systems, cameras, DVD players, etc., or use of a product with any non-Christie interface device.
- e) Problems or damage caused by the use of any lamp, replacement part or component purchased or obtained from an unauthorized distributor of Christie lamps, replacement parts or components including, without limitation, any distributor offering Christie lamps, replacement parts or components through the internet (confirmation of authorized distributors may be obtained from Christie).
- f) Problems or damage caused by misuse, improper power source, accident, fire, flood, lightning, earthquake or other natural disaster.
- g) Problems or damage caused by improper installation/alignment, or by equipment modification, if by other than Christie service personnel or a Christie authorized repair service provider.
- h) Problems or damage caused by use of a product on a motion platform or other movable device where such product has not been designed, modified or approved by Christie for such use.
- i) Problems or damage caused by use of a projector in the presence of an oil-based fog machine or laser-based lighting that is unrelated to the projector.
- j) For LCD projectors, the warranty period specified in the warranty applies only where the LCD projector is in "normal use" which means the LCD projector is not used more than 8 hours a day, 5 days a week.
- k) Except where the product is designed for outdoor use, problems or damage caused by use of the product outdoors unless such product is protected from precipitation or other adverse weather or environmental conditions and the ambient temperature is within the recommended ambient temperature set forth in the specifications for such product.
- l) Image retention on LCD flat panels.
- m) Defects caused by normal wear and tear or otherwise due to normal aging of a product.

The warranty does not apply to any product where the serial number has been removed or obliterated. The warranty also does not apply to any product sold by a reseller to an end user outside of the country where the reseller is located unless (i) Christie has an office in the country where the end user is located or (ii) the required international warranty fee has been paid.

The warranty does not obligate Christie to provide any on site warranty service at the product site location.

PREVENTATIVE MAINTENANCE

Preventative maintenance is an important part of the continued and proper operation of your product. Please see the Maintenance section for specific maintenance items as they relate to your product. Failure to perform maintenance as required, and in accordance with the maintenance schedule specified by Christie, will void the warranty.

REGULATORY (if applicable)

The product has been tested and found to comply with the limits for a Class A digital device, pursuant to Part 15 of the FCC Rules. These limits are designed to provide reasonable protection against harmful interference when the product is operated in a commercial environment. The product generates, uses, and can radiate radio frequency energy and, if not installed and used in accordance with the instruction manual, may cause harmful interference to radio communications. Operation of the product in a residential area is likely to cause harmful interference in which case the user will be required to correct the interference at the user's own expense.

CAN ICES-3 (A) / NMB-3 (A)

이 기기는 업무용(A급)으로 전자파적합등록을 한 기기이오니 판매자 또는 사용자는 이점을 주의하시기 바라며, 가정 외의 지역에서 사용하는 것을 목적으로 합니다.

Laite on liitettävä suojakoskettimilla varustettuun pistorasiaan

Apparatet må tilkoples jordet stikkontakt

Apparaten skall anslutas till jordat uttag

Apparatets stikprop skal tilsluttes en stikkontakt med jord, som giver forbindelse til stikproppens jord.

ENVIRONMENTAL

The product is designed and manufactured with high-quality materials and components that can be recycled and reused. This symbol  means that electrical and electronic equipment, at their end-of-life, should be disposed of separately from regular waste. Please dispose of the product appropriately and according to local regulations. In the European Union, there are separate collection systems for used electrical and electronic products. Please help us to conserve the environment we live in!

Addendum

Translated copies of this document are provided on the CD in the back of this document. The CD may also contain additional product documentation. Read all instructions before using or servicing this product.

Le CD au dos de ce document contient des traductions de celui-ci dans différentes langues. Ce CD peut également contenir de la documentation supplémentaire sur le produit. Lisez toutes les instructions avant d'utiliser ou d'entretenir ce produit.

Übersetzte Versionen dieses Dokuments werden auf der CD auf dem Vorsatzblatt dieses Dokuments bereitgestellt. Die CD kann auch zusätzliche Produktdokumentation enthalten. Bitte lesen Sie diese Anweisungen vor der Verwendung dieses Produkts oder vor der Ausführung von Wartungsarbeiten am Produkt.

Le copie tradotte di questo documento sono fornite sul CD, sul retro di questo documento. Il CD potrebbe anche contenere altra documentazione sul prodotto. Si prega di leggere tutte le istruzioni prima di utilizzare questo prodotto o sottoporlo a manutenzione.

このドキュメントの翻訳版がこのドキュメントの裏面のCDで提供されています。CDには追加の製品マニュアルも収められています。この製品を使用したり、機能させたりする前に、すべての指示をお読みください。

Перевод данного документа представлен на компакт-диске на оборотной стороне документа. Компакт-диск может также содержать дополнительную документацию по продукту. Перед использованием или обслуживанием продукта ознакомьтесь со всеми инструкциями.

Las copias traducidas de este documento se proporcionan en el CD que se encuentra en la parte trasera. En el CD también puede encontrar documentación adicional del producto. Lea todas las instrucciones antes de utilizar o realizar el mantenimiento de este producto.

Content

- Before using the product 10**
- Package Handling 11**
 - Unpacking 11
 - Handling and care 12
 - Cleaning 12
- Introduction 13**
 - Key features and benefits..... 13
 - Parts list 13
- Controls and functions 14**
 - Using the keypad 15
 - Input / Output panel..... 15
 - Remote Control..... 17
- Installation 18**
 - Quick setup 18
 - Ventilation Considerations 19
 - Mounting the Display 19
 - Connections to the Display 19
 - Connecting a Control System or PC 20
 - Connecting the IR receiver kit..... 21
 - Connecting Source Components to the Display 22
 - DisplayPort Source Connection 22
 - HDMI Source Connections..... 22
 - RGBHV (VGA) Source Connection..... 23
 - Turning on the Power 24
 - Avoiding Image Retention 24
 - Changing the OSD Language 24
 - Enabling the Touch Screen 24
 - Connecting the Touch Screen Controller Host Computer to the Display 25
 - Touch Requirements..... 25
 - Operating System Compatibility..... 26
- Operation 27**

Using the On-Screen Menus.....	27
Picture settings.....	29
Input.....	29
Picture mode.....	29
Brightness.....	29
Contrast.....	29
Black Level.....	30
Color.....	30
Sharpness.....	31
Color Temperature.....	31
Adjust Settings (VGA Source).....	32
Auto Setup (VGA source).....	32
Image Position (VGA source).....	32
Clock (VGA source).....	33
Phase (VGA source).....	33
Input Resolution (VGA source).....	33
Sound Settings.....	33
Audio Input.....	33
Volume.....	34
Balance.....	34
OSD Settings.....	34
Language.....	34
OSD Turn off.....	34
Setup Settings.....	35
Power Save.....	35
Movie Mode.....	35
Interface Select.....	35
Factory Reset.....	35
Multi-Window.....	36
Multi-Window Modes.....	36
Window1 – Window4.....	36
Maintenance and Troubleshooting.....	38
Maintenance.....	38
Troubleshooting.....	38
Serial Communications.....	40
RS232 connection and port configuration.....	40

Command and response format 40

Serial Command List..... 41

Specifications 50

 LCD Panel 50

 Signal compatibility / Connectivity..... 50

 Mechanical 51

 OSD functions..... 51

 Electrical 51

 Touch panel..... 51

 Environmental 52

 Supported Timings 52

Before using the product



Warning! Failure to comply with the following could result in death or serious injury.

- Christie products must be installed and serviced by Christie qualified technicians.
- A minimum of four people or adequately rated lifting equipment are required to safely lift, install, or move the product.
- **SHOCK HAZARD!** Only use the AC power cord provided with the product or recommended by Christie.
- **SHOCK HAZARD!** Disconnect the product from AC before servicing, cleaning, removing components, or opening any enclosure.
- **FIRE HAZARD!** Do not use a power cord that appears damaged.
- **SHOCK HAZARD!** Do not attempt operation if the AC supply is not within the specified voltage and power range, as specified on the license label.
- **SHOCK HAZARD!** The AC power cord must be inserted into an outlet with grounding.
- Always connect the ground first to reduce shock hazard.
- **TRIP OR FIRE HAZARD!** Position all cables where they cannot contact hot surfaces, be pulled, be tripped over, or damaged by persons walking on or objects rolling over the cables.



Notice. Failure to comply with the following may result in property damage.

- Install the product at least 10 cm far from the wall. Otherwise it may affect internal temperature to be increased and cause a fire.
- Do not install in locations where has vibration or in an unstable position. Product fall may occur and it might cause a damage. This may cause a fire.
- Do not install in places which dirt, moisture, smoke, much water or rain water can reach.
- Avoid exposure to direct sunlight and do not place near hot objects such as a fire or heater heat. This may cause a fire or shortening the product life.
- Do not place heavy objects on the product.
- Always provide proper ventilation for the product to prevent overheating.
- Do not place the screen on a hard surface.

Package Handling



Warning! Failure to comply with the following could result in death or serious injury.

- A minimum of four people or adequately rated lifting equipment are required to safely lift, install, or move the product.



Notice. Failure to comply with the following may result in property damage.

- Do not drop the panel or apply pressure to the sides of the bezel. The small size of the bezel, which enables minimal image-to-image gaps, means there is reduced protection of the LCD glass and components. Dropping the panel or applying unnecessary force to the sides of the bezel will result in permanent damage.
- Extreme care must be taken when pushing the mounted display into its locked position. Always handle the display on the opposing corners of the frame to avoid direct contact with the LCD glass.

Due to the delicate nature of the display, we strongly recommend that you use the provided packing materials and secure the package onto a pallet during shipment.

Unpacking



Warning! Failure to comply with the following could result in death or serious injury.

- A minimum of four people or adequately rated lifting equipment are required to safely lift, install, or move the product.

To protect the panel during transportation, each LCD panel is packed inside a box carton and additional packing material has been placed within the carton.

1. Before unpacking, prepare a stable, level, and clean surface near a wall outlet.
2. Set the box in an upright position and pull out the white carton locks.
3. Lift off the top cover carton.
4. Remove the ESD bag before removing the display from the bottom tray carton.
5. Remove the panel from the bottom tray carton.

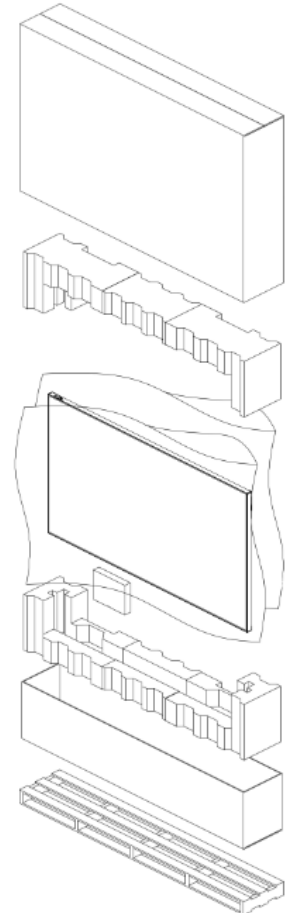

Handling and care



Caution! Failure to comply with the following could result in minor or moderate injury.

- Make sure the power connector and any other cables are unplugged before moving the product.

To avoid damaging your LCD panel, follow these guidelines when handling or moving the panel:

- Always use the handles on the back of the LCD panel. Do not hold onto the frame when transporting.
- Four people are required when moving or raising the LCD panel.
- Hold and support the LCD panel at each side and keep at an even height above the ground.
- Do not twist or bend the panel.
- Use a cart to move the panel.
- To avoid damaging the screen, when the panel is sitting on a surface do not tilt it more than 10°.

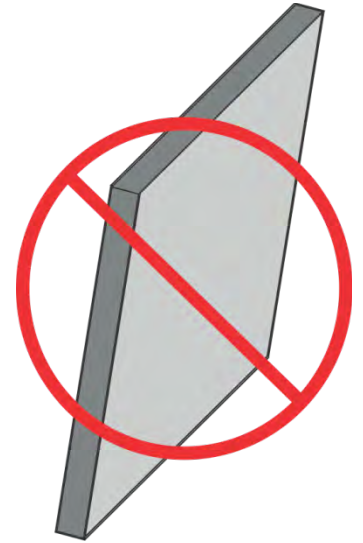

Cleaning



Notice. Failure to comply with the following may result in property damage.

- Do not clean the product directly with a wet cloth or wet spray water.

Unplug the power cord before cleaning the LCD panel. Do not use a liquid, spray cleaners, or any abrasive cleaners to clean the LCD panel.

After disconnecting the power cable, wipe contaminated parts and each part of the product screen lightly with a dry and soft cloth.

When washing by various cleaning agents, brighteners, abrasives, waxes, benzene, alcohol, solvent, surface active agent, the surface of the product may be damaged.

Introduction

This Owner's Manual describes how to install, set up and operate the LCD Panels. Throughout this manual, the LCD Panels are referred to collectively as the "display."

The LCD Panel represent the cutting edge of direct-view LCD technology. They combine ultra-high resolution and unparalleled image quality with configurable I/O in a large-format display.

Key features and benefits

The display offers these key features and benefits:

- Ultra-HD Native Resolution: 3840 x 2160 (16:9 Native Aspect Ratio)
- High Brightness: Up to around 400 nits
- Ultra-wide 178-degree Viewing Angle
- Display Port 1.2, HDMI1.4b Inputs with High-bandwidth Digital Content Protection (HDCP)
- Supported OPS(Open Pluggable Specification) slot: HDMI1.4b, DisplayPort 1.1, RS232
- Touch Capability:
 - Precise, highly responsive touch technology
 - High touch sensitivity—no pressure required
 - Any touch: finger, gloved hand or pointer
 - OS compatibility : Windows 7 and 8/8.1 , Mac OSX, Linux

Parts list

Your display is shipped with the following items. If any items are missing or damaged, please contact your dealer or Customer Service.

- LCD Panel
- User manual
- IR Remote Controller Unit and battery (2 AAA)
- RS232 Cable (Length 1800mm)
- USB Cable (Length 3000mm)
- External IR Receiver Kit
- Screw (M3x6) 2ea

Controls and functions

The illustration below shows the key display components. The appearance of actual components may differ from the image shown.

FHQ552-T

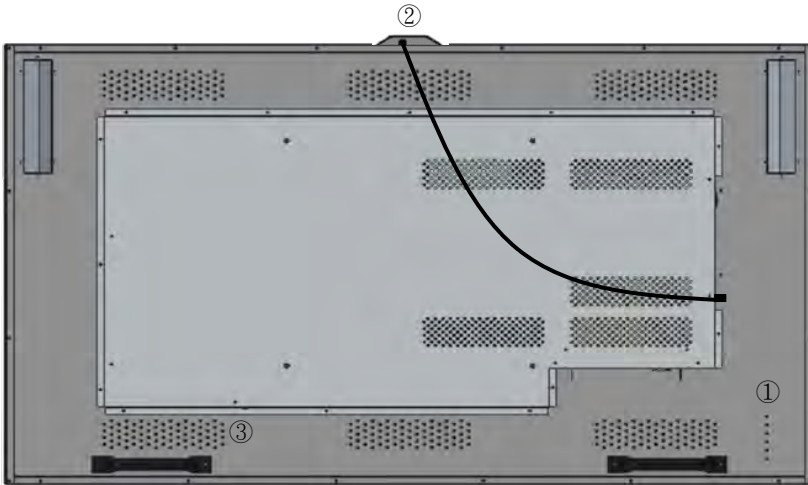

FHQ842-T

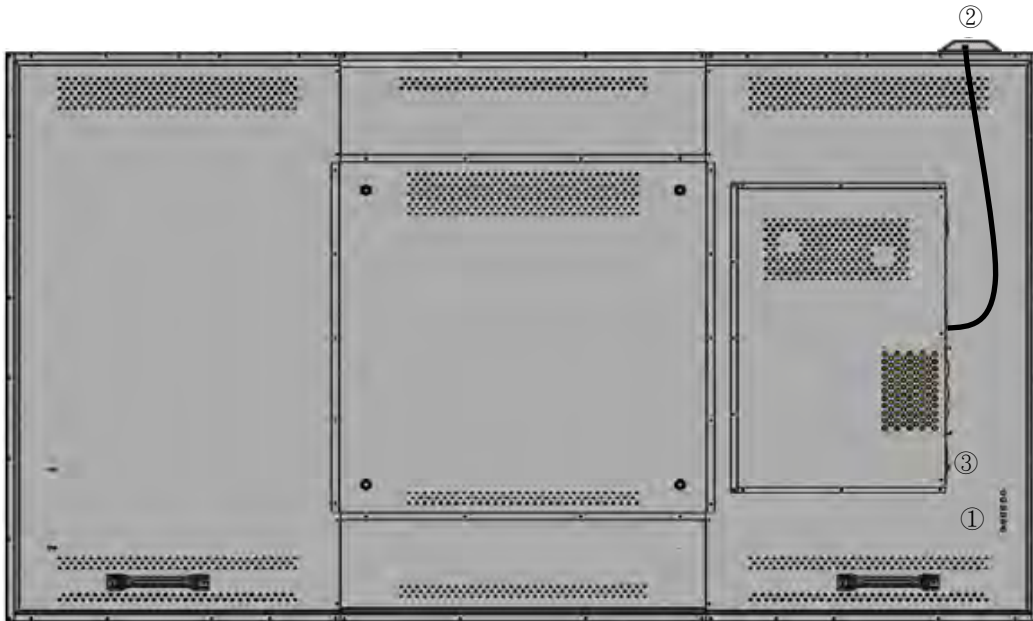

- | | |
|----------|---|
| 1 | <p>Main power input and switch
Connects or disconnects the display panel from the AC power source.
100 to 240 VAC, 50/60Hz</p> |
| 2 | <p>IR receiver / power status LED</p> |

	<ul style="list-style-type: none"> • On—Green or No color • Standby—Red • Power Save—Red-Green blinking or Red blinking
3	Keypad

Using the keypad

Use the keypad instead of the remote control unit to operate the on-screen display (OSD) controls.

Button	Description
 On/Standby	Press once to toggle from standby mode to on mode. Press it again to return to standby mode.
▲ Source	With no menus visible, to select a source press the ▲ (SOURCE) button repeatedly. When a menu is visible, this button operates as an up arrow.
▼	When a menu is visible, this button operates as a down arrow.
+	Increases the volume. When a menu is visible, this button operates identically to the right-arrow (or SEL) button on the display remote control unit.
-	Decreases the volume. When a menu is visible, this button operates identically to the left-arrow button on the display remote control unit.
M Menu	Displays the display (OSD), or exits the on-screen display (OSD) and return to the previous menu.

Input / Output panel

FHQ552-T

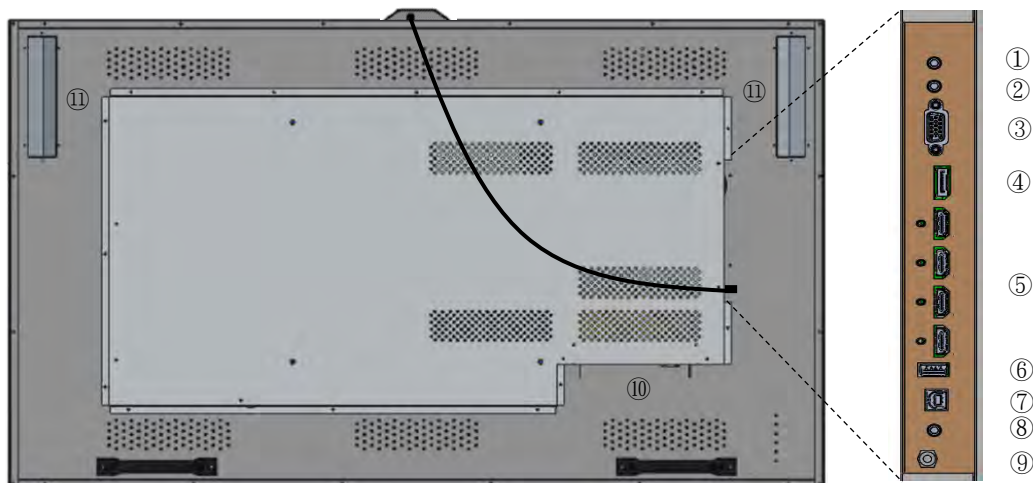

FHQ842-T

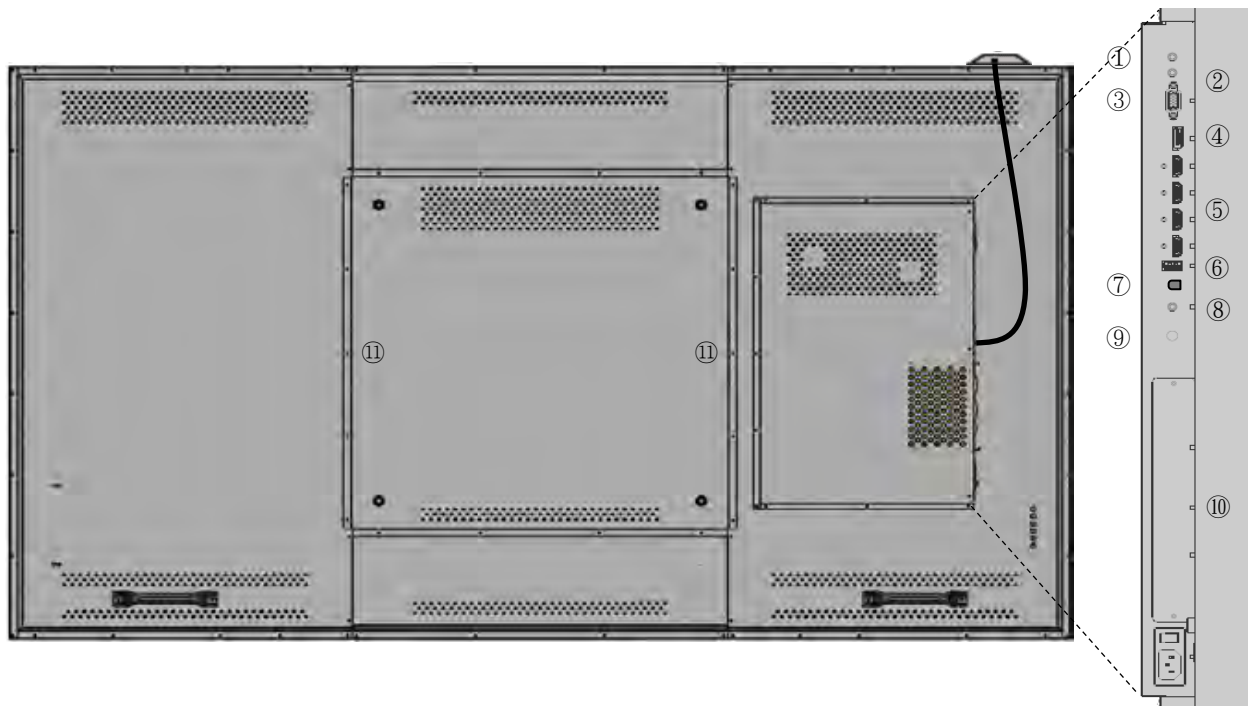

1	Audio Out (3.5 mm 3 pole) To connect audio stereo output.	7	Touch In (USB B type) To connect touch control system.
2	Audio In (3.5 mm 3 pole) To connect audio input.	8	RS232C In (3.5 mm 3 pole) To connect an RS232 input cable with a control device.
3	VGA In (15-pin D-Sub) To connect RGBHV (VGA) video input.	9	IR In (3.5 mm 4 pole) To connect the external IR receiver kit.
4	DisplayPort In To connect DisplayPort 1.1a video and audio input.	10	OPS Slot (OPS Module is optional) To connect an OPS (Open Pluggable Specification) PC.
5	HDMI 1 ~ 4 In To connect HDMI 1.4b video and audio input.	11	Internal Speaker (2 x 10W)
6	Service In (USB A type) To connect with a USB device for software update.		

Remote Control



	Label	Description
1		Turns on or off the product
2	SOURCE	Select a connected source device
3		Move to the up menu
4		Move to the down menu
5	SEL	Confirm a menu selection
6	or -	Decreases the sound volume or Move to the left menu
7	or +	Increases the sound volume or Move to the right menu
8	MENU	Opens the product on-screen menu system. When the menu system is already open, pressing this button will select the previous submenu
9	INFO	Provides source and resolution information
10	MUTE	Turns off the sound
11	AUTO	Auto adjustment of VGA source

When using the remote, follow these precautions:

- Make sure nothing is obstructing the infrared beam between the remote control and the IR receiver on the display.
- If the effective range of the remote control decreases or stops working, replace the batteries.
- The remote control may fail to operate if the infrared remote sensor is exposed to bright sunlight or fluorescent lighting.
- Make sure that the battery polarities are correct when installing the batteries.
- If the remote control will not be used for a long time, remove the batteries to avoid damage from battery leakage.
- Do not expose batteries to excessive heat such as from sunshine or fire.

Installation

Christie products must be installed and serviced by Christie qualified technicians.

Proper installation of your display ensures a satisfying viewing experience. Whether you are installing a display temporarily or permanently, take the following into account to ensure optimal performance.

In general, minimize or eliminate light sources directed at the screen. Contrast ratio in your images will be noticeably reduced if light directly strikes the screen, such as light from a window or floodlight falling on the image. Images may then appear washed out and less vibrant.

Keep the ambient temperature constant and below 35°C (95°F). Keep the display away from heating and/or air conditioning vents.

Quick setup

Here is a quick overview of the display installation process. The sections following this one provide detailed instructions.

1. Mount the display.
See Mounting the Display on page 19.
2. Connect other external equipment to the display.
See Connecting a Control System or PC on page 20.
3. Connect signal sources to the display.
See Connecting Source Components to the Display on page 22.
4. Apply power to the display.
See Turning on the Power on page 24.
5. Change the OSD language.
See Changing the OSD Language on page 24.
6. Calibrate the display for each input.
See Picture settings on page 29.

Ventilation Considerations

If you are mounting the display in an enclosure, leave sufficient space between the display and surrounding objects on all sides, as shown below. This allows heat to disperse, maintaining the proper operating temperature.

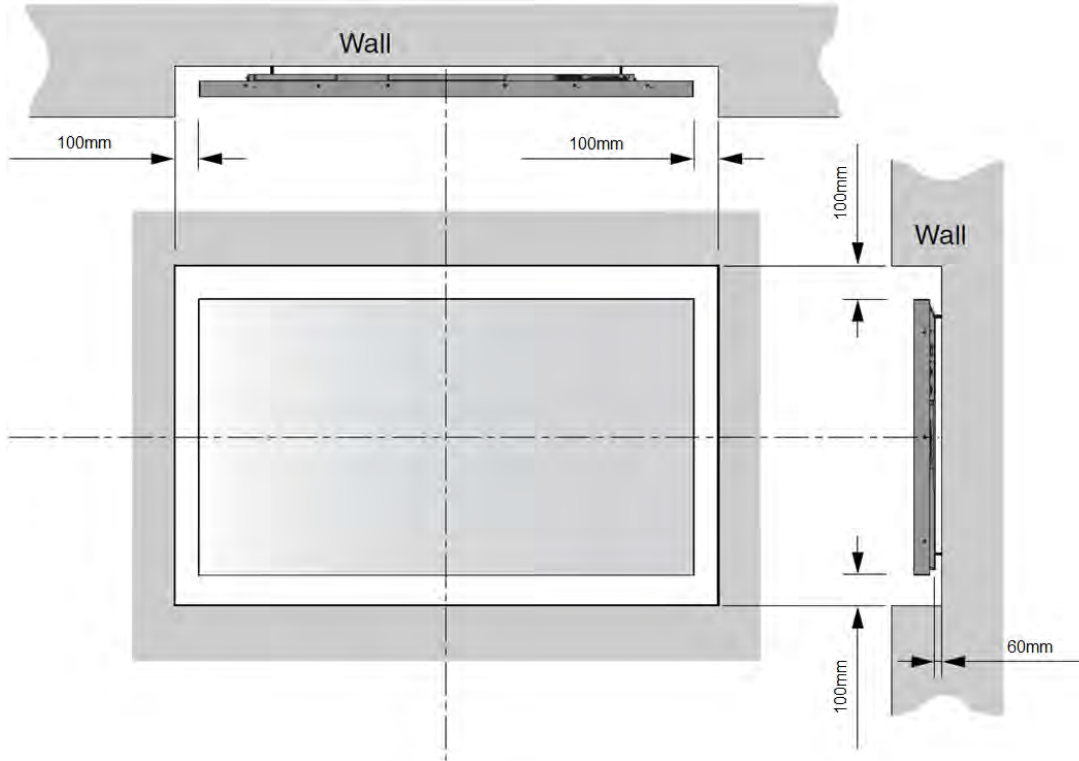

Mounting the Display



Caution! Failure to comply with the following could result in minor or moderate injury.

- Use only the approved wall-mount kit designed for your display
- Christie products must be installed and serviced by Christie qualified technicians.

If the display is mounted on a wall, ensure that the wall-mount bracket is installed according to the instructions included with it. The wall must be capable of supporting a redundant weight factor three times the weight of the display, or be reinforced.

Connections to the Display

Connect the display to your video sources, external controller(s) and AC power.

When connecting your equipment:

- Turn off all equipment before making any connections.
- Use the correct signal cables for each source.

- For best performance and to minimize cable clutter, use high-quality cables that are only as long as necessary to connect two devices. For example do not use a 20-foot cable when a 6-foot cable will suffice.
- Ensure that the cables are securely connected. Tighten any thumbscrews on connectors.

Connecting a Control System or PC

Use a straight-through RS232 cable with a 3.5 mm stereo connector to connect a PC or control / automation system to the RS232 port on the display. For more information about using this connection, refer to Serial Communications on page 40.

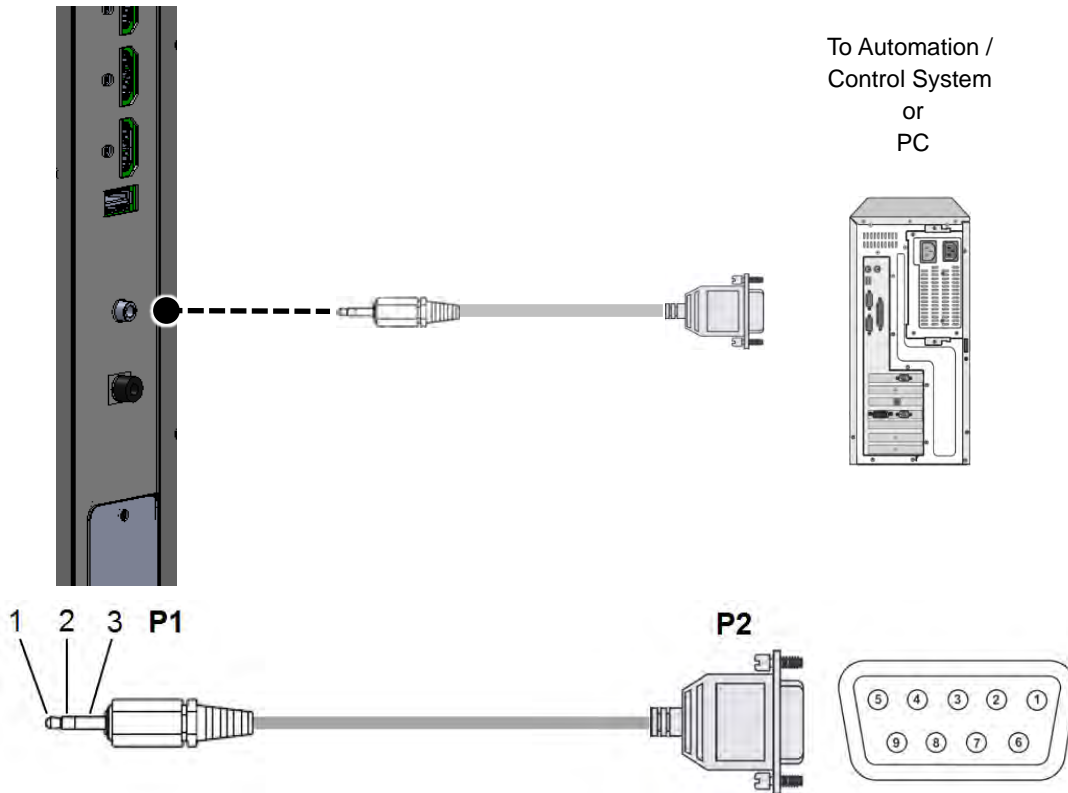

P1				P2		
Stereo	Tx	1	←	2	Rx	DSUB9P
3.5 mm	Rx	2	→	3	Tx	(Female)
	Gnd	3	—	5	Gnd	

Connecting the IR receiver kit

Connect the provided External IR Receiver Kit to the IR input as shown below.

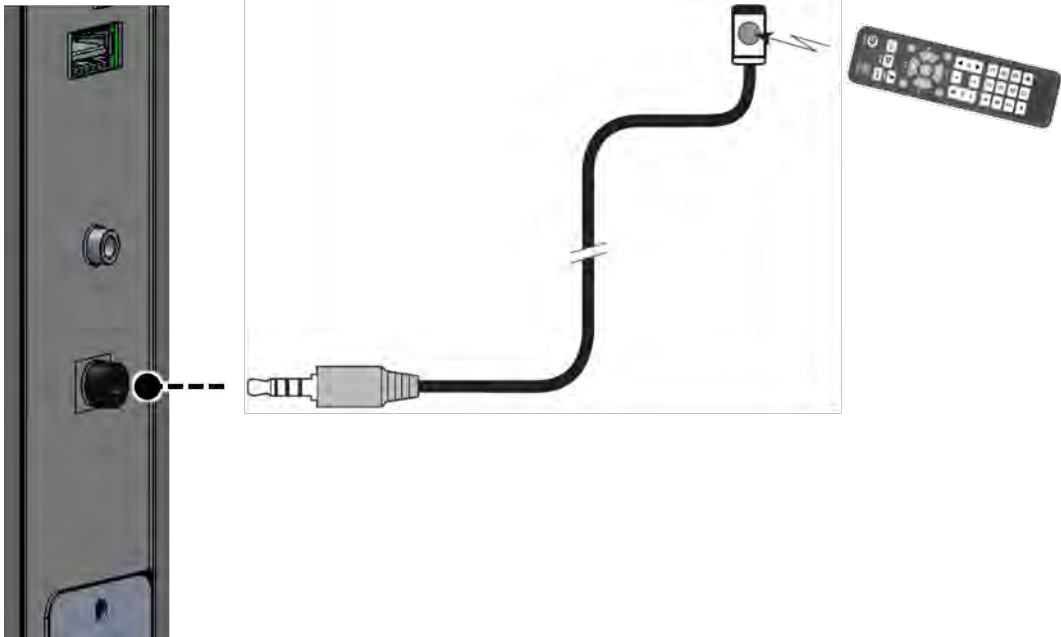

Attach the external remote sensor to the external remote sensor on the product by removing two screws on the top/bottom of the left/middle/right of the front, and re-using the screw.

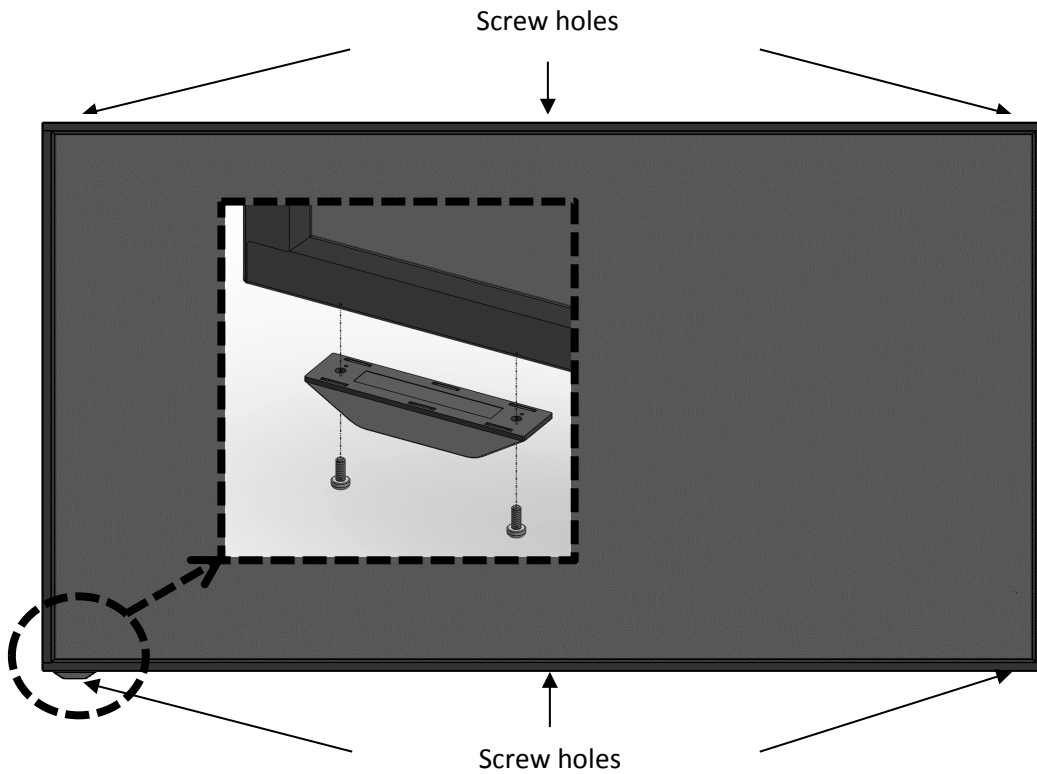

Connecting Source Components to the Display

Connect your video sources to the display as shown and described in the sections that follow. For a list of compatible input signals, refer to Supported Timings on page 52.

DisplayPort Source Connection

This display supports the VESA Display Data Channel (DDC) standard, and provides “Plug and Play” capability. The display and a VESA DDC-compatible computer communicate their setting requirements, allowing for quick and easy setup.

For Plug and Play to work correctly, you must turn on the display before you turn on the connected computer.

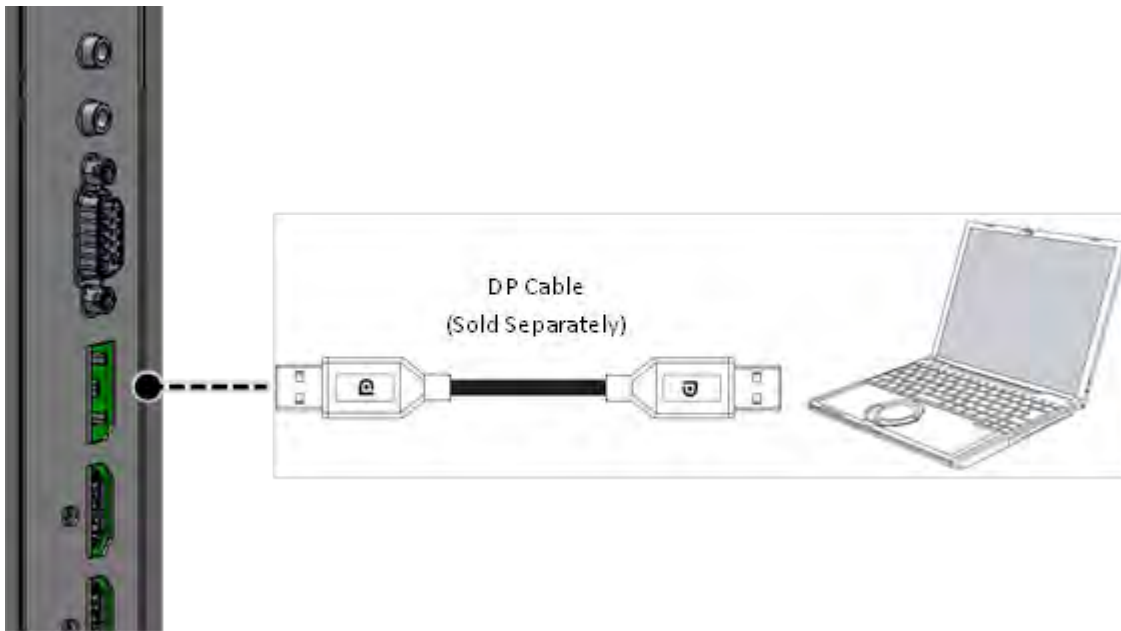

HDMI Source Connections

This display supports the VESA Display Data Channel (DDC) standard, and provides “Plug and Play” capability. The display and a VESA DDC-compatible computer communicate their setting requirements, allowing for quick and easy setup.

For Plug and Play to work correctly, you must turn on the display before you turn on the connected computer.

Be sure to purchase a certified HDMI cable or the picture may not display or a connection error may occur.

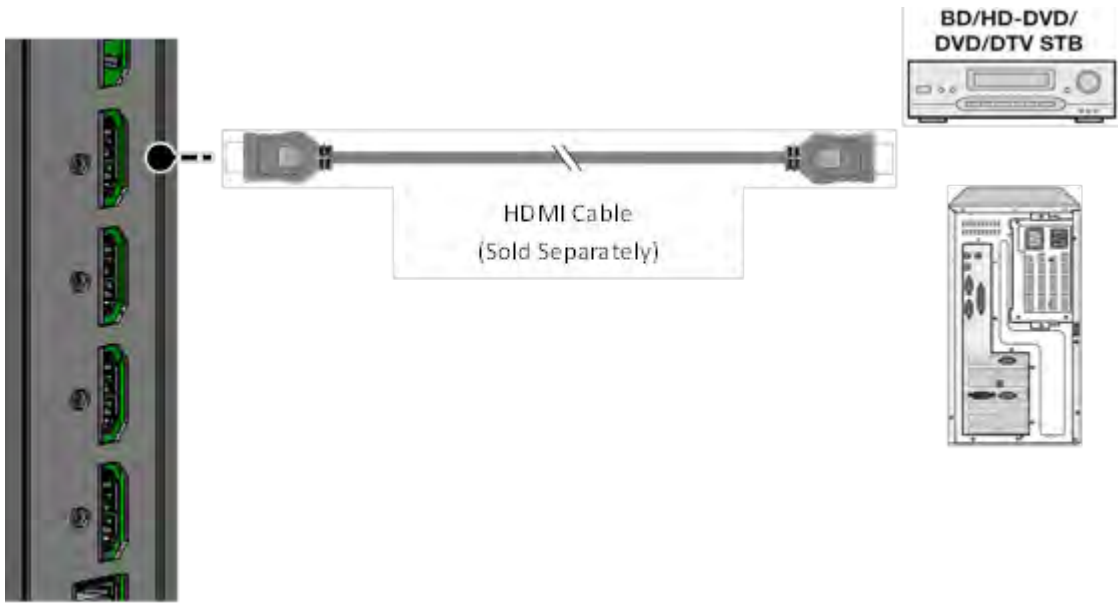

RGBHV (VGA) Source Connection

Connect a personal computer or other RGB source to the VGA input as shown below.

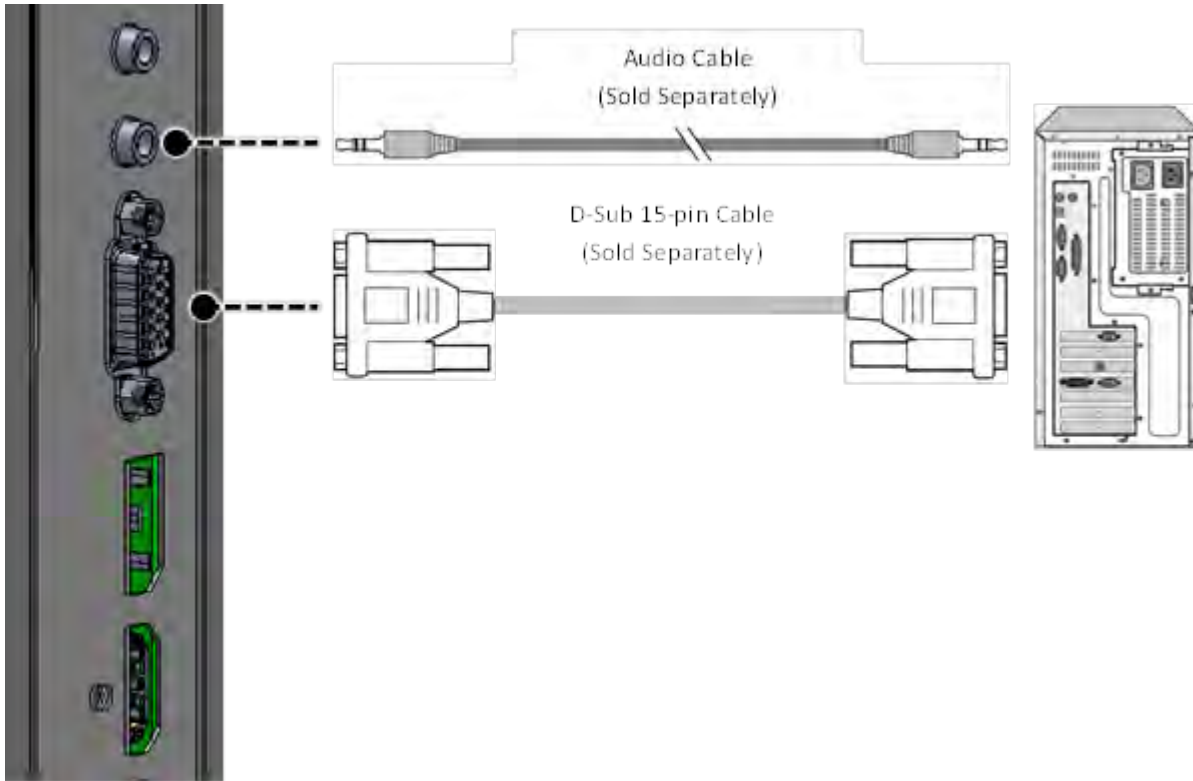

Turning on the Power

1. Connect the power cable of the product into outlet with AC 100-220V 50/60Hz.
2. Turn on the main AC power switch.
3. If the power indicator is green, the screen turns on automatically.
4. If the power indicator is red, press the power key on the remote control or on the keypad to turn on the power.

Avoiding Image Retention

To prolong the life of the display:

- Operate the display within its rated ambient environment
- Operating temperature: 5°C to 35°C (41°F to 95°F)
- Relative humidity: 80%, maximum.

Do not display static (non-moving) content on the display for long periods of time. This may cause image image retention, which is not covered under warranty.

To avoid static content:

- Display dynamic (moving) images whenever possible . Consider using a screen saver to avoid displaying static video content continuously.
- Turn off the display when not in use.

Changing the OSD Language

Select the language used for the menus and on screen display.

1. Press the Menu button to go to the menu.
2. Select the OSD from the main menu.
3. Select the language field and select the correct language.

The available languages are English, French, German, Italian, Russian, Spanish, and Korean

4. Exit the menu.

Enabling the Touch Screen

Before setting up your LCD panel to support touch screen capability, ensure that:

- The touch screen controller host computer is turned **off**.
- The display is turned on.
- The video output from the computer is connected to a video input on the display.

Connecting the Touch Screen Controller Host Computer to the Display

Use the provided USB cable to connect the touch screen controller host computer to the USB input as shown below.

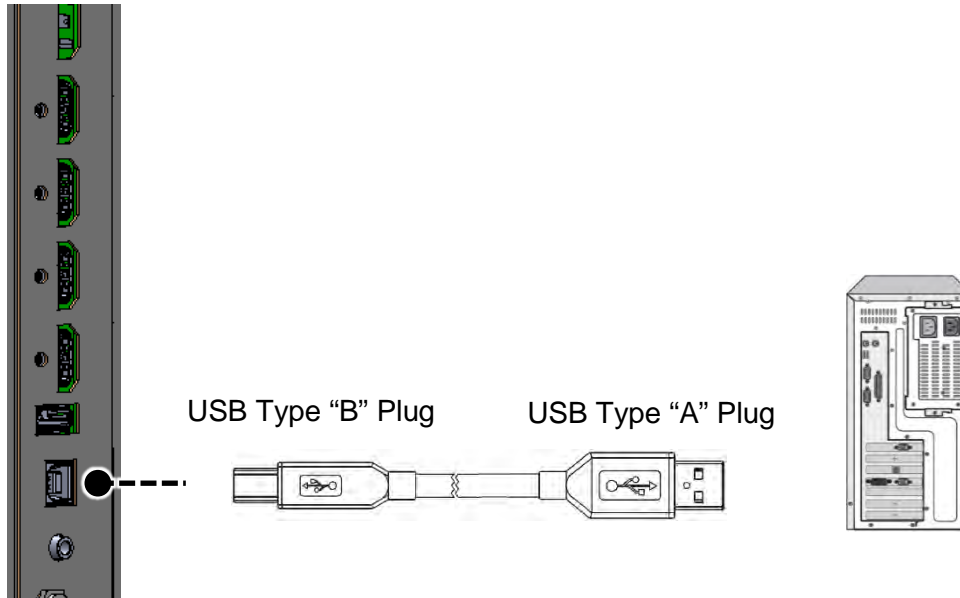

After (and **only** after) making this connection, turn on your host computer.

Touch Requirements

Hardware Requirements

Computer Configuration (Minimum):

- 2.2 GHz dual-core processor
- 1 GB RAM
- 10 GB available hard disk space
- 128 MB Nvidia Geforce 6600T graphics card

Computer Configuration (Recommended):

- 2.5 GHz quad-core processor
- 3 GB RAM
- 10 GB available hard disk space
- 1 GB Nvidia GTX330 graphics card

Operating System Compatibility

OS	Version	Single touch	Multi touch	Plug and Play	Optional software packages	
Windows	Windows 8	Professional	O	O	O	X
	Windows 8.1	Professional	O	O	O	X
	Windows 7	Ultimate	O	O	O	X
		Enterprise	O	O	O	X
		Professional	O	O	O	X
		Home premium	O	O	O	X
		Home Basic	O	X	O	X
	Starter	O	X	O	X	
	Vista	Home Premium	O	X	O	X
	Windows XP	Professional	O	X	O	X
		Home	O	X	O	X
	Embedded	Win7	O	O	O	X
Win XP		O	X	O	X	
Mac OSX	Lion	10.7.5	O	O	X	Device Driver
	Mountain Lion	10.8.5	O	O	X	Device Driver
	Mavericks	10.9.1/10.9.5	O	O	X	Device Driver
	Yosemite	10.10.X	O	O	X	Device Driver
Linux	Ubuntu	10.04/12.10/14.04	O	O	X	Device Driver
	Fedora	15,16,19,20	O	O	X	Device Driver
	OpenSUSE	11.4/12.1/12.2/12.3	O	O	X	Device Driver
	CentOS	6.6	O	O	X	Device Driver
	Mint	14.1	O	O	X	Device Driver

Operation

Using the On-Screen Menus

The OSD menus are arranged hierarchically, as shown below. Depending on the selected input source and signal characteristics, some menu options may not be available.

- To display the on-screen menus, press **MENU** on the remote control or built-in keypad.
- To select a sub-menu, use the **▲** and **▼** buttons to highlight it. Then, press **SEL** to enter that sub-menu.
- To select a menu item, use the **▲** and **▼** and buttons to highlight it. Then, press **▲** or **▼** to adjust that setting, and then the menu by pressing the menu button to exit.

	Input	Window1	Window1/Window2/ Window3/Window4	For Multi-window
Picture	Picture Mode	Standard	Standard/Dynamic/User	Default: Standard Select User to adjust Brightness, Contrast and other settings manually.
	Brightness	70	0-100	
	Contrast	100	0-100	
	Black Level	47	0-100	
	Color	50	0-100	
	Sharpness	50	0-100	
	Color Temperature	Normal	Normal/Warm/Cool/Studio1/ Studio2/User	Default: Normal
	Red	90	0-100	
	Green	90	0-100	
	Blue	90	0-100	
	Adjust	Auto Setup		
H Position		0	0-100	
V Position		0	0-100	
Clock		0	0-100	
Phase		0	0-100	
Input Resolution		1024x768	1024x768/1280x768/1360x768	Default: 1024x768

			1366x768/1400x1050/1680x1050	
Sound	Audio Input		Audio In/DP/HDMI1/HDMI2/ HDMI3/HDMI4/OPS-HDMI/OPS-DP	Different depends on current input
	Volume	50	0-100	Default: 50
	Balance	0	-50 - +50	Default: 0
OSD	Language	English	English / Spanish /French / Russian / German /Italian / Korean	Default: -
	OSD Turn Off	Off	Off/5/10/20sec	Default: Off
Setup	Power Save	On		Default: On
	Movie Mode	Off	Off / Low / Middle / High	Default: Off
	Interface Select	Off	Off/RS232/OPS-RS232	Default: Off
	Factory Reset			Reset the all MENU
Multi-Window	Multi-Window Mode	Off	Off/Dual/Quad	Default: Off
	Window1		DP/HDMI1/HDMI2/HDMI3/ HDMI4/OPS-HDMI/OPS-DP (Max resolution: 1920x1080p@60Hz)	Default: DP
	Window2			Default: HDMI1
	Window3			Default: HDMI2
	Window4			Default: HDMI3
About	Model		The read-only System menu provides the following status information about the display	
	Version			
	S/N			
	Window1			
	Resolution			
	Window2			
	Resolution			
	Window3			
	Resolution			
	Window4			
Resolution				

Picture settings



Input

The image quality depends on the input modes when Multi-Window is On.

The Input function is disabled when Multi-Window is OFF.

Picture mode

1. Select **Picture Settings > Picture Mode**.
2. Press **▲** or **▼** to select one of two image quality presets (Standard or Dynamic) depending on the type of program material you are viewing. These presets automatically adjust the other image settings for optimal image quality.

Or, select **User** to adjust Brightness, Contrast and other settings manually.

Brightness

The Backlight control changes the apparent brightness of the displayed image.

Contrast

1. On your external test pattern source, select a stepped, gray-bar pattern like the one shown below.

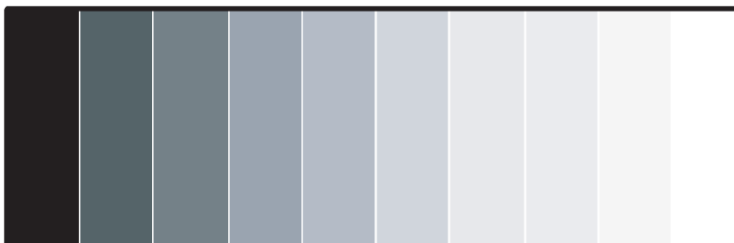

2. Select **Contrast** and press ▲ or ▼ to adjust the contrast to a point just below which the white rectangle starts to increase in size.

Black Level

1. On your external test pattern source, select a PLUGE pattern.

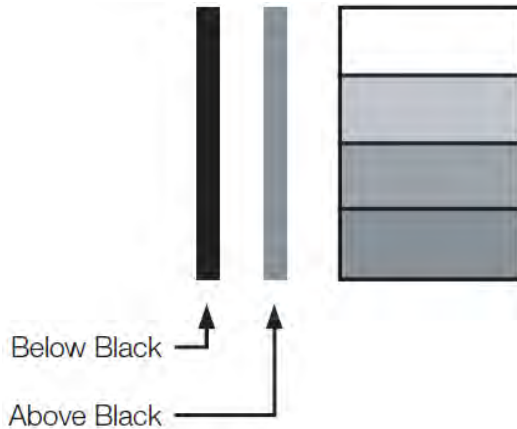

PLUGE patterns vary but generally consist of some combination of black, white and gray areas against a black background. The example above includes two vertical bars and four shaded boxes. Contrast and Black Level controls are interactive. A change to one may require a subtle change to the other in order to achieve the optimum setting.

2. Select **Picture Settings** > **Black Level** and press ▲ or ▼ to adjust the black level until:
 - The darkest black bars disappear into the background.
 - The dark gray areas are barely visible.
 - The lighter gray areas are clearly visible.
 - The white areas are a comfortable level of true white.
 - The image contains only black, gray and white (no color).

Color

Color, Hue, and Tint are the ratio of red to green in the color portion of the image. When Color is decreased, the image appears redder; when it is increased the image appears greener.

1. To adjust the color, use a blue filter when viewing the color bar pattern, as you would for adjusting color saturation. Like the brightness and contrast controls, the color and tint controls are interactive. A change to one may require a subtle change to the other in order to achieve the optimum setting.
2. Select **Color** from the Picture Settings menu and press ▲ or ▼ to adjust it until the cyan and magenta color bars (on either side of the green bar) appear to be a single shade of blue.

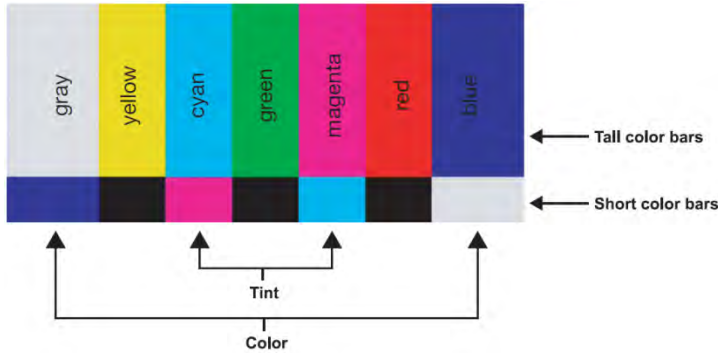

Sharpness

Sharpness is the amount of high-frequency detail in the image.

1. To adjust sharpness, select **Picture Settings > Sharpness**.
2. On your external test pattern source, select a pattern like the one shown below.

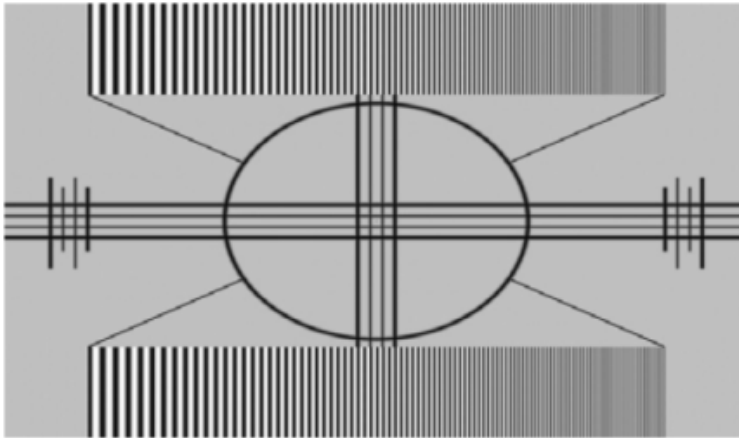

3. Adjust as needed, looking for white edges around the transitions from black to gray and differently-sized lines in the “sweep” patterns at the top and bottom. Lower the sharpness setting to eliminate them.

Color Temperature

A “color temperature” is the x/y coordinate pair that defines a color’s location on the standard CIE chromaticity graph, shown below.

1. Select **Color Temperature** from the Picture Settings menu to adjust the color temperature.
 - Studio1 = about 3200K
 - Studio2 = about 5600K
 - Warm = about 6500K
 - Normal = about 10000K
 - Cool = 11500K

Touchboards

205 Westwood Ave, Long Branch, NJ 07740
Phone: 866-94 BOARDS (26273) / (732)-222-1511
Fax: (732)-222-7088 | E-mail: sales@touchboards.com

2. Select a value of from 3200K(Studio1) to 11500K(Cool). Higher settings produce a “bluer” picture; lower ones impart a reddish hue to the image.

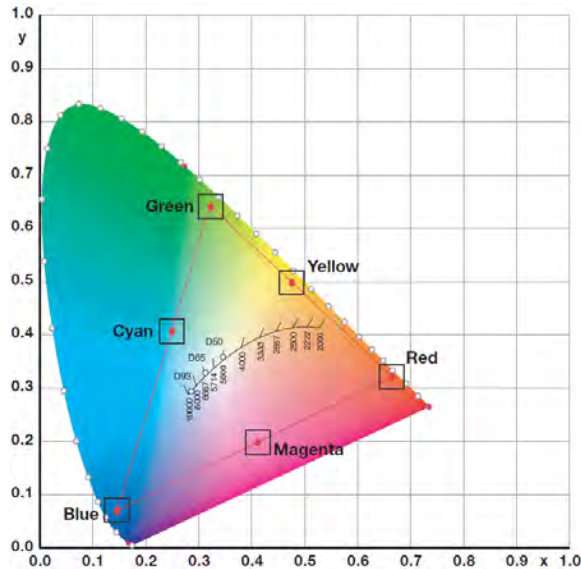

3. To select a custom color temperature, select **User** and set the **Gain** and **Offset**.

Adjust Settings (VGA Source)



Auto Setup (VGA source)

To force the display to reacquire and lock to the input signal, select **Picture Settings > Auto Adjust**. This is useful when the signal quality is marginal.

Image Position (VGA source)

This control sets to fine-tune the image position.

- H Position: Press ▲ to shift the image to the right; press ▼ to shift it to the left.

- V Position: Press ▲ to shift the image upward; press ▼ to shift it downward.

Clock (VGA source)

This control sets the frequency of the pixel sampling clock, indicated by the number of incoming pixels per line, so that all pixels generated by a particular source are sampled. Steady flickering or several soft vertical stripes or bands across the entire image indicates poor pixel tracking. Proper pixel tracking helps ensure that the image quality is consistent across the screen, that aspect ratio is maintained and that pixel phase can be optimized.

Phase (VGA source)

This control adjusts the phase of the pixel sampling clock relative to the incoming signal. Adjust the phase when an image still shows shimmer or “noise” after the Clock setting has been optimized. Adjust the Phase after adjusting Size

For best results, use a good test pattern such as a smooth gray consisting of a clear pattern of black and white pixels, or a similar “half on, half off” graphic image. Adjust the slide bar until the image stabilizes and each pixel is clearly defined. You may notice that you can stabilize the image at more than one point. Use either setting in such cases.

Input Resolution (VGA source)

If the vertical resolution is 768 or 1050, select the same resolution as the input resolution.

Sound Settings

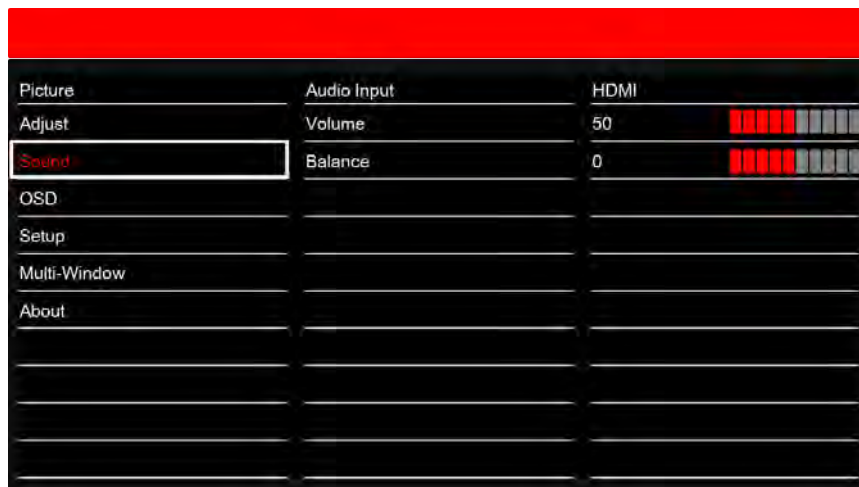

Audio Input

Select audio input source [Audio In],[DP],[HDMI1],[HDMI2],[HDMI3],[HDMI4],[OPS-HDMI],[OPS-DP].

Volume

The volume can be changed or the sound can be muted using the slider bar in the range of 0 to 100.

Balance

Adjust the volume of the left and right speakers of the selected display device. (-50 ~ +50)

OSD Settings



Picture	Language	English
Adjust	OSD Turn Off	5sec.
Sound		
OSD		
Setup		
Multi-Window		
About		

Language

To select the OSD Language, select **OSD Settings > OSD Language** and press ▲ or ▼. The available languages are English, French, German, Italian, Russian, Spanish, and Korean.

OSD Turn off

To specify how long the menus remain on-screen after selecting them, select **OSD Settings > OSD Timeout**. The available times are 5 seconds, 10 seconds, 20 seconds, and Off.

Setup Settings



Picture	Power Save	On
Adjust	Movie Mode	Off
Sound	Interface Select	Off
OSD	Factory Reset	
Setup		
Multi-Window		
About		

Power Save

The display enters power-saving mode.

Movie Mode

Adjusts the amount of blurring and juddering of the moving image.

- Off—When connecting to a game console, you can enjoy a more realistic gaming experience by Selecting Off.
- Low / Middle / High—When you watch movies, you can enjoy a smoother image.

Interface Select

Select the control Interface, RS232 or OPS-RS232 or Off

If you select RS232 or OPS-RS232, the monitor cannot lower the power consumption.

Factory Reset

To reset ALL display settings (including image settings) back to their factory defaults, select **Setup Settings** > **Factory Reset**.

Multi-Window

Picture	Multi-Window Modes	On
Adjust	Window1	HDMI1
Sound	Window2	HDMI2
OSD	Window3	HDMI3
Setup	Window4	DP1
Multi-Window		
About		

Multi-Window Modes

1. Select **Multi-Window Settings > Multi-Window Modes**. (Off/Dual/Quad)
2. For the video processor to overlay the selected input modes into various split-screen views for presentation, select Off, Dual, or Quad. The max resolution is 1920x1080p@60Hz.

Window1 – Window4

Select a Dual/Quad input source.

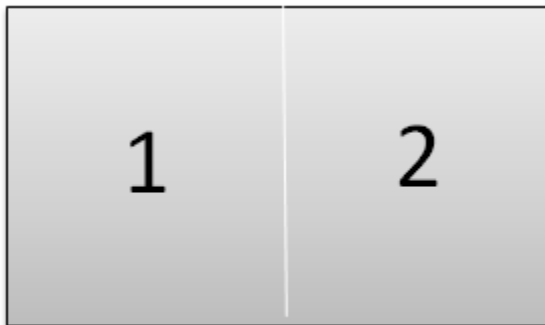

<Dual>

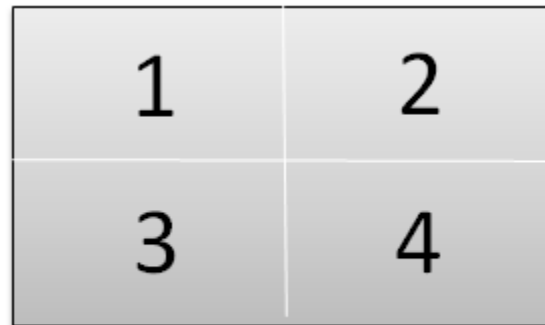

<Quad>

Possible multiple screen combinations:

Dual/Quad		Sub screen							
		PC	DP	HDMI 1	HDMI 2	HDMI 3	HDMI 4	OPS HDMI	OPS DP
Main Screen	PC	X	X	X	X	X	X	X	X
	DP	X	O	O	O	O	O	O	O

HDMI1	X	O	O	O	O	O	O	O	O
HDMI2	X	O	O	O	O	O	O	O	O
HDMI3	X	O	O	O	O	O	O	O	O
HDMI4	X	O	O	O	O	O	O	O	O
OPS-HDMI	X	O	O	O	O	O	O	O	X
OPS-DP	X	O	O	O	O	O	O	X	O

(O : The input can be selected. / X : The input can not selected.)

Maintenance and Troubleshooting

Maintenance

The LCD Panel does not require any routine maintenance. There are no user-serviceable or user-replaceable parts. Unless you are a qualified, factory-trained technician, do not attempt to repair or replace any system component yourself as it will void the product warranty if you do so.

Troubleshooting

The table below provides some general guidelines for troubleshooting problems you may encounter with your display. If the suggested solutions fail to resolve the problem or if you encounter an issue not described here, please contact your dealer.

Symptom	Possible causes	Solution
The display does not turn on.	<ul style="list-style-type: none"> The display is not plugged in or the AC outlet is not active. The main power switch is off. The remote control batteries have run out. 	<ul style="list-style-type: none"> Ensure that the display is plugged in and that the AC outlet is active. Set the main power switch to the on position. See Controls and functions on page 14. Replace the batteries.
The display is on and menus appear, but there is no picture.	<ul style="list-style-type: none"> Incorrect source selection. Source component is not turned on. Source component is connected incorrectly or not at all. 	<ul style="list-style-type: none"> Select the correct source. Turn on the source component. Check connections from the source component to the display.
The remote control does not work.	<ul style="list-style-type: none"> The remote control batteries have run out. 	<ul style="list-style-type: none"> Replace the batteries.
The display is jittery or unstable.	<ul style="list-style-type: none"> Poor-quality or improperly connected source. The horizontal or vertical scan frequency of the input signal may be out of range for the display. 	<ul style="list-style-type: none"> Ensure that the source is properly connected and of adequate quality for detection. Correct at the source.
Image is too bright and/or lacks definition in the bright areas of the image.	<ul style="list-style-type: none"> Contrast is set too high. 	<ul style="list-style-type: none"> Decrease the contrast setting.
Image appears “washed out” and/or dark areas appear too bright.	<ul style="list-style-type: none"> Black level is set too high. 	<ul style="list-style-type: none"> Decrease the black level setting.
Image is too dark.	<ul style="list-style-type: none"> Black level and/or brightness are set too low. 	<ul style="list-style-type: none"> Increase the black level and/or brightness settings.
Images from an HDMI source do not	<ul style="list-style-type: none"> The resolution and frequency of the video card in the computer are not compatible with the 	<ul style="list-style-type: none"> Select a compatible resolution and vertical frequency. Refer to Supported

display.	<p>display.</p> <ul style="list-style-type: none">• HDMI cable from source to display is either defective or too long.	<p>Timings on page 52.</p> <ul style="list-style-type: none">• Try a different and/or shorter HDMI cable.
Computer images do not display correctly.	<ul style="list-style-type: none">• The resolution and frequency of the video card in the computer are not compatible with the display.• Clock and Phase settings need adjustment.	<ul style="list-style-type: none">• Select a compatible resolution and vertical frequency. Refer to Supported Timings on page 52.• Adjust Clock and Phase settings. Refer to Clock (VGA source) on page 33 and Phase (VGA source) on page 33.
Touch screen doesn't work	<ul style="list-style-type: none">• Multi-touch controller host computer is not connected correctly.	<ul style="list-style-type: none">• See Connecting the Touch Screen Controller Host Computer to the Display on page 25.

Serial Communications

In addition to using the display keypad or remote control unit, you can control the display using a serial (RS232) link or Ethernet connection to send commands and receive responses to those commands.

The display uses a simple text-based control protocol to take requests from control devices and to provide responses to such devices. This section describes how to send control messages over a serial link between the display and an automation/control system or a PC running a terminal emulation program.

RS232 connection and port configuration

Connect your control system or PC to the RS232 input of the display. Configure the RS232 controller or PC serial port as follows: no parity, 8 data bits, 1 stop bit and no flow control. Set the baud rate to 9600bps, to match that of the display RS232 port. Refer to Connecting a Control System or PC on page 20.

Command and response format

Commands sent from an automation/control system or PC to the display must have the following format:

Direct Command Format (from computer)

Format: [HEAD][SET ID][COMMAND][END]

Example (Power on) K:ALLPON.

[HEAD] indicates the start of the command data (always K:).

[SET ID] is the display ID (always ALL).

[COMMAND] is the command data (3Bytes).

[END] indicates the end of the command data (always .).

Value Adjust Format (from computer)

Format: [HEAD][SET ID][COMMAND][VALUE][END]

Example (Volume level 50%) K:ALLVOL050.

[HEAD] indicates the start of the command data (always K:).

[SET ID] is the display ID (always ALL).

[COMMAND] is the command data (3Bytes).

[VALUE] is the parameter setting for the command (000~100).

[END] indicates the end of the command data (always .).

Status Check Command Format (from computer)

Format: [HEAD][SET ID][COMMAND][END]

Example (Source status HDMI1) K:ALLSRC?

[HEAD] indicates the start of the command data (always K:).

[SET ID] is the display ID (always ALL).

[COMMAND] is the command data (3Bytes).

[END] indicates the end of the command data (always ?).

Response: HDMI1=002

Status Check Response Format (from Product)

Format: [SET ID][:][COMMAND][=][REPLY]

Example (Source status HDMI1) ALL:SRC=002

[SET ID] is the display ID (always ALL).

[:] is always ":".

[COMMAND]] is the command data (3Bytes).

[=] is always "=".

[Reply] is the reply data (3Bytes).

Response : HDMI1=002

OK Acknowledgement

The product transmits ACK (acknowledgement) based on this format when receiving normal data. At this time, if the data is in read mode, it indicates present status data. If the data is in write mode, it returns the data of the PC computer.

Format : [ALL][:][Command][=][A]

Example : ALL:PON=A

Error Acknowledgement

If there is error, it returns NG

Format : [ALL][:][Command][=][N]

Example : ALL:PON=N

Serial Command List

Main item	Control item	Command	Value	Reply
Direct Control	Power Key Off	POF		
Direct Control	Power Key On	PON		
Direct Control	Source change to VGA	SPC		

Direct Control	Source change to DP	SH1		
Direct Control	Source change to HDMI 1	SH2		
Direct Control	Source change to HDMI2	SH3		
Direct Control	Source change to HDMI3	SH4		
Direct Control	Source change to HDMI 4	SH5		
Direct Control	Source change to OPS/HDMI	SH6		
Direct Control	Source change to OPS/DP	SH7		
Direct Control	Window Mode set to Window1	WN1		
Direct Control	Window Mode set to Window2	WN2		
Direct Control	Window Mode set to Window3	WN3		
Direct Control	Window Mode set to Window4	WN4		
Direct Control	Picture Mode Standard	PM0		
Direct Control	Picture Mode Dynamic	PM1		
Direct Control	Picture Mode User	PM2		
Direct Control	Brightness 1step Up	BLU		
Direct Control	Brightness 1step Down	BLD		
Direct Control	Contrast 1step Up	CTU		
Direct Control	Contrast 1step Down	CTD		
Direct Control	Black Level 1step Up	BRU		
Direct Control	Black Level 1step Down	BRD		
Direct Control	Color 1step Up	STU		
Direct Control	Color 1step Down	STD		
Direct Control	Sharpness 1step Up	SPU		
Direct Control	Sharpness 1step Down	SPD		
Direct Control	Color temperature set to Studio1	CT0		
Direct Control	Color Temperature set to Studio2	CT1		
Direct Control	Color Temperature set to Warm	CT2		
Direct Control	Color temperature set to Normal	CT3		
Direct Control	Color Temperature set to Cool	CT4		

Direct Control	Color Temperature set to User	CT5		
Direct Control	Red Gain 1step Up	RGU		
Direct Control	Red Gain 1step Down	RGD		
Direct Control	Green Gain 1step Up	GGU		
Direct Control	Green Gain 1step Down	GGD		
Direct Control	Blue Gain 1step Up	BGU		
Direct Control	Blue Gain 1step Down	BGD		
Direct Control	Auto Adjust (only VGA input)	ATU		
Direct Control	H-Position 1step Up	HPU		
Direct Control	H-Position 1step Down	HPD		
Direct Control	V-Position 1step Up	VPU		
Direct Control	V-Position 1step Down	VPD		
Direct Control	Clock 1step Up	CKU		
Direct Control	Clock 1step Down	CKD		
Direct Control	Phase 1step Up	PHU		
Direct Control	Phase 1step Down	PHD		
Direct Control	Input Resolution 1024*768	IR0		
Direct Control	Input Resolution 1280*768	IR1		
Direct Control	Input Resolution 1360*768	IR2		
Direct Control	Input Resolution 1366*768	IR3		
Direct Control	Input Resolution 1400*1050	IR4		
Direct Control	Input Resolution 1680*1050	IR5		
Direct Control	Sound Audio In	AI0		
Direct Control	Sound DP	AI1		
Direct Control	Sound HDMI 1	AI2		
Direct Control	Sound HDMI 2	AI3		
Direct Control	Sound HDMI 3	AI4		
Direct Control	Sound HDMI 4	AI5		
Direct Control	Sound OPS/HDMI	AI6		

Direct Control	Sound OPS/DP	AI7		
Direct Control	Volume Up	VLU		
Direct Control	Volume Down	VLD		
Direct Control	Balance 1step Down	BCD		
Direct Control	Balance 1step Up	BCU		
Direct Control	OSD Language German	LGE		
Direct Control	OSD Language English	LES		
Direct Control	OSD Language Spanish	LSP		
Direct Control	OSD Language French	LFR		
Direct Control	OSD Language Italiano	LIT		
Direct Control	OSD Language Korean	LKR		
Direct Control	OSD Language Russian	LRU		
Direct Control	OSD Time Off	OT0		
Direct Control	OSD Time 5Sec	OT1		
Direct Control	OSD Time 10Sec	OT2		
Direct Control	OSD Time 20Sec	OT3		
Direct Control	Power Save Off	PSF		
Direct Control	Power Save On	PSO		
Direct Control	Movie Mode Off	MM0		
Direct Control	Movie Mode Low	MM1		
Direct Control	Movie Mode Middle	MM2		
Direct Control	Movie Mode High	MM3		
Direct Control	Interface Select Off	UA0		
Direct Control	RS-232	UA1		
Direct Control	OPS/RS-232	UA2		
Direct Control	Factory Reset	FTR		
Direct Control	Multi-Window Mode Off	WM0		
Direct Control	Multi-Window Mode PBP	WM1		
Direct Control	Multi-Window Mode Quadrant	WM2		

Direct Control	Window1 Input DP	W10		
Direct Control	Window1 Input HDMI1	W11		
Direct Control	Window1 Input HDMI2	W12		
Direct Control	Window1 Input HDMI3	W13		
Direct Control	Window1 Input HDMI4	W14		
Direct Control	Window1 Input OPS/HDMI	W15		
Direct Control	Window1 Input OPS/DP	W16		
Direct Control	Window2 Input DP	W20		
Direct Control	Window2 Input HDMI1	W21		
Direct Control	Window2 Input HDMI2	W22		
Direct Control	Window2 Input HDMI3	W23		
Direct Control	Window2 Input HDMI4	W24		
Direct Control	Window2 Input OPS/HDMI	W25		
Direct Control	Window2 Input OPS/DP	W26		
Direct Control	Window3 Input DP	W30		
Direct Control	Window3 Input HDMI1	W31		
Direct Control	Window3 Input HDMI2	W32		
Direct Control	Window3 Input HDMI3	W33		
Direct Control	Window3 Input HDMI4	W34		
Direct Control	Window3 Input OPS/HDMI	W35		
Direct Control	Window3 Input OPS/DP	W36		
Direct Control	Window4 Input DP	W40		
Direct Control	Window4 Input HDMI1	W41		
Direct Control	Window4 Input HDMI2	W42		
Direct Control	Window4 Input HDMI3	W43		
Direct Control	Window4 Input HDMI4	W44		
Direct Control	Window4 Input OPS/HDMI	W45		
Direct Control	Window4 Input OPS/DP	W46		
Direct Control	Remote control Source key	RSO		

Direct Control	Remote control Up key	RUP		
Direct Control	Remote control Down key	RDN		
Direct Control	Remote control Right key	RRT		
Direct Control	Remote control Left key	RLT		
Direct Control	Remote control Select key	REN		
Direct Control	Remote control Menu key	RMN		
Direct Control	Remote control Auto key	RAT		
Direct Control	Remote control Info key	RIF		
Direct Control	Mute On	MON		
Direct Control	Mute Off	MOF		
Value Adjust	Brightness setting	BLT	0~100	
Value Adjust	Contrast setting	CON	0~100	
Value Adjust	Black Level setting	BRT	0~100	
Value Adjust	Color setting	SAT	0~100	
Value Adjust	Sharpness Value setting	SHA	0~100	
Value Adjust	Red Gain Setting	RGN	0~100	
Value Adjust	Green Gain Setting	GGN	0~100	
Value Adjust	Blue Gain Setting	BGN	0~100	
Value Adjust	H-Position Setting	HPS	0~100	
Value Adjust	V-Position Setting	VPS	0~100	
Value Adjust	Clock Setting	CLK	0~100	
Value Adjust	Phase Setting	PHS	0~100	
Value Adjust	Volume	VOL	0~100	
Value Adjust	Balance	BCT	0~100	
Status check	Selected Window Status	WIN		001=Window1 002=Window2 003=Window3 004=Window4
Status check	Picture Mode	PMT		000=Standard 001=Dynamic 002=User

Status check	Brightness Setting	BLT		0~100
Status check	Contrast Value Setting	CON		0~100
Status check	Black Level Value Setting	BRT		0~100
Status check	Color Setting	SAT		0~100
Status check	Sharpness Value Setting	SHA		0~100
Status check	Color temperature	CTT		000=Studio1 001=Studio2 002=Warm 003=Normal 004=Cool 005=User
Status check	Red Gain Setting	RGN		0~100
Status check	Green Gain Setting	GGN		0~100
Status check	Blue Gain Setting	BGN		0~100
Status check	H-Position Setting	HPS		0~100
Status check	V-Position Setting	VPS		0~100
Status check	Clock Setting	CLK		0~100
Status check	Phase Setting	PHS		0~100
Status check	Input Resolution Status	IRT		000=1024*768 001=1280*768 002=1360*768 003=1366*768 04=1400*1050 05=1680*1050
Status check	Audio Input Status	AUT		000=Audio In 001=DP 002=HDMI 1 003=HDMI 2 004=HDMI 3 005=HDMI 4 006=OPS-HDMI 007=OPS-DP
Status check	Volume	VOL		0~100
Status check	Balance	BCT		0~100
Status check	OSD Language	LAT		000=English 001=German 002=Spanish 003=French 004=Italian

				005=Russian 006=Korean
Status check	OSD Turn Off	OTT		000=Off 001=5Sec 002=10Sec 003=20Sec
Status check	Power Save	PST		000=Off 001=On
Status check	Movie Mode Status	MMT		000=Off 001=Low 002=Middle 003=High
Status check	UART Status	UAT		000=Off 001=RS232 002=OPS RS232
Status check	Multi-Window Mode Status	WMT		000=Off 001=Dual 002=Quad
Status check	Window1 Source Status	W1S		000=DP 001=HDMI 1 002=HDMI 2 003=HDMI 3 004=HDMI 4 005=OPS-HDMI 006=OPS-DP
Status check	Window2 Source Status	W2S		000=DP 001=HDMI 1 002=HDMI 2 003=HDMI 3 004=HDMI 4 005=OPS-HDMI 006=OPS-DP
Status check	Window3 Source Status	W3S		000=DP 001=HDMI 1 002=HDMI 2 003=HDMI 3 004=HDMI 4 005=OPS-HDMI 006=OPS-DP
Status check	Window4 Source Status	W4S		000=DP 001=HDMI 1 002=HDMI 2 003=HDMI 3 004=HDMI 4 005=OPS-HDMI 006=OPS-DP
Status check	Current source	SRC		000=VGA 001=DP

				002=HDMI 1 003=HDMI 2 004=HDMI 3 005=HDMI 4 006=OPS-HDMI 007=OPS-DP
Status check	Mute Status	MUT		000=Off 001=On

Specifications

Due to continuing research, specifications are subject to change without notice.

LCD Panel

Item	Description	
	FHQ552-T	FHQ842-T
Brightness	Typical 300 cd/m2	Typical 320 cd/m2
Contrast Ratio	Minimum 750:1, Typical 1000:1	
Viewing Angle	H: 178° / V: 178°	
Response Time	Typically 5 ms	Typically 8 ms
Supported Colors	1.06 billion colors (10bit)	
Display Resolution	3840 x 2160 (16:9)	
Display Frame Rate	120 Hz	
Surface hardness of tempered glass	< 6H	

Signal compatibility / Connectivity

Item	Description
Horizontal / Vertical Frequency	Analog: 31.5 ~ 67.5 KHz / 59 ~ 71 Hz
	Digital: 31.5 ~ 135 KHz / 30 ~ 71 Hz
Input Resolution	VGA(Analog): up to 1920 x 1080 @ 60 Hz HDMI / OPS-HDMI / OPS-DP: up to 3840 x 2160 @ 30 Hz DisplayPort: up to 3840 x 2160 @ 60 Hz
Connectors	Audio Out / Audio In / VGA In / DisplayPort In / HDMI In x 4 / Service In / IR In / OPS(OPS-HDMI/OPS-DP/OPS-RS232)
Communication Ports	RS232C In / IR In / OPS-RS232
Internal Speaker	10W x 2 (Input: Maximum 1 Vrms)

Mechanical

Item	Description	
	FHQ552-T	FHQ842-T
Dimensions	1,314.5 x 783.6 x 100 mm	1,976 x 1,161 x 104.5 mm
Weight	Net: 42 kg / 93 lbs; Gross: 53 kg / 117 lbs	Net: 98 kg / 216 lbs; Gross: 120 kg / 265 lbs
Wall Mount	400mm x 400mm VESA (screw M8 (25mm))	600mm x 600mm VESA (screw M8 (25mm))

OSD functions

Item	Description
Control	Built-in Keypad, IR Remote Controller, RS232
Language	English, French, German, Italian, Russian, Spanish, Korean

Electrical

Item	Description	
	FHQ552-T	FHQ842-T
Rated Input Voltage	AC 100V ~ 240V (50/60 Hz), 2.8-1.17 Amps	AC 100V ~ 240V (50/60 Hz), 6.2-2.58 Amps
Power Consumption	Panel: Max 160W Panel with OPS PC : Max 280W (It can supply up to 120W to the OPS PC.)	Panel: Max 500W Panel with OPS PC : Max 620W (It can supply up to 120W to the OPS PC.)
Power Consumption (standby mode)	Less than 0.5 W (Without OPS PC)	Less than 0.5 W (Without OPS PC)

Touch panel

Item	Description	
	FHQ552-T	FHQ842-T
Touch Detection Method	Infrared rays	
Available touch points	Max 10 points simultaneous (Over 90% area)	
Minimum space touch to touch	60mm	
Input Method	Blunt Pen, Finger of gloved hand Activation	

Available Object (minimum size for touch)	Single-9mm Multi-12mm	Single-12mm Multi-12mm
Touch Accuracy	Max 5mm	
Interface	USB 2.0 Full Speed	

Environmental

Item	Description
Operating Temperature	0 ~ 40 °C, 20~80% RH
Storage Temperature	-20 ~ 60 °C, 5~90% RH

Supported Timings

O = Compliant timing / - = Non-compliant timing.

Timing	fH (kHz)	fV (Hz)	Dot clock (MHz)	VGA	HDMI	DP	OPS HDMI	OPS DP
VESA	720 x 400	31.5	70.156	26.25	O	O	O	O
	640 x 480	31.469	59.95	25.175	O	O	O	O
	800 x 600	37.879	60.317	40	O	O	O	O
	1024 x 768	48.363	60.004	65	O	O	O	O
	1360 x 768	47.712	60.015	85.5	O	O	O	O
	1920 x 1080	67.5	60	148.5	O	O	O	O
SD	480p	31.5	60	27.03	-	O	O	O
	576p	31.25	50	27	-	O	O	O
HD	720p	37.5	50	74.25	-	O	O	O
		44.995	59.94	74.176	-	O	O	O
		45	60	74.25	-	O	O	O
	1080i	28.13	50	74.25	-	O	O	O
		33.716	59.94	74.175	-	O	O	O
		33.75	60	74.25	-	O	O	O
	1080p	56.25	50	148.5	-	O	O	O

		67.432	59.95	148.35	-	0	0	0	0
		67.5	60	148.5	-	0	0	0	0
UHD	2160p	67.5	30	297	-	0	0	0	0
	2160p	135	60	594	-	-	0	-	-



205 Westwood Ave, Long Branch, NJ 07740
Phone: 866-94 BOARDS (26273) / (732)-222-1511
Fax: (732)-222-7088 | E-mail: sales@touchboards.com



ASSY TECH DOCS FHQ55-84-T

Corporate offices

USA – Cypress
ph: 714-236-8610

Canada – Kitchener
ph: 519-744-8005

Consultant offices

Italy
ph: +39 (0) 2 9902 1161

Worldwide offices

Australia
ph: +61 (0) 7 3624 4888

Brazil
ph: +55 (11) 2548 4753

China (Beijing)
ph: +86 10 6561 0240

China (Shanghai)
ph: +86 21 6278 7708

Eastern Europe and
Russian Federation
ph: +36 (0) 1 47 48 100

France
ph: +33 (0) 1 41 21 44 04

Germany
ph: +49 2161 664540

India
ph: +91 (080) 6708 9999

Japan (Tokyo)
ph: 81 3 3599 7481

Korea (Seoul)
ph: +82 2 702 1601

Republic of South Africa
ph: +27 (0)11 510 0094

Singapore
ph: +65 6877-8737

Spain
ph: +34 91 633 9990

United Arab Emirates
ph: +971 4 3206688

United Kingdom
ph: +44 (0) 118 977 8000