

Phoenix System

Reference Manual

020-101183-16

CHRISTIE

Phoenix System

Reference Manual

020-101183-16

NOTICES

COPYRIGHT AND TRADEMARKS

Copyright © 2019 Christie Digital Systems USA, Inc. All rights reserved.

All brand names and product names are trademarks, registered trademarks or trade names of their respective holders.

GENERAL

Every effort has been made to ensure accuracy, however in some cases changes in the products or availability could occur which may not be reflected in this document. Christie reserves the right to make changes to specifications at any time without notice. Performance specifications are typical, but may vary depending on conditions beyond Christie's control such as maintenance of the product in proper working conditions. Performance specifications are based on information available at the time of printing. Christie makes no warranty of any kind with regard to this material, including, but not limited to, implied warranties of fitness for a particular purpose. Christie will not be liable for errors contained herein or for incidental or consequential damages in connection with the performance or use of this material.

WARRANTY

Products are warranted under Christie's standard limited warranty, the complete details of which are available by contacting your Christie dealer or Christie. In addition to the other limitations that may be specified in Christie's standard limited warranty and, to the extent relevant or applicable to your product, the warranty does not cover:

- a) Problems or damage occurring during shipment, in either direction.
- b) Problems or damage caused by combination of a product with non-Christie equipment, such as distribution systems, cameras, DVD players, etc., or use of a product with any non-Christie interface device.
- c) Problems or damage caused by the use of any replacement part or component purchased or obtained from an unauthorized distributor of Christie replacement parts or components including, without limitation, any distributor offering Christie replacement parts or components through the Internet (confirmation of authorized distributors may be obtained from Christie).
- d) Problems or damage caused by misuse, improper power source, accident, fire, flood, lightning, earthquake or other natural disaster.
- e) Problems or damage caused by improper installation/alignment, or by equipment modification, if by other than Christie service personnel or a Christie authorized repair service provider.
- f) Problems or damage caused by use of a product on a motion platform or other movable device where such product has not been designed, modified, or approved by Christie for such use.
- g) Problems or damage caused by use of a projector in the presence of an oil-based fog machine or laser-based lighting that is unrelated to the projector.
- h) Except where the product is designed for outdoor use, problems or damage caused by use of the product outdoors unless such product is protected from precipitation or other adverse weather or environmental conditions and the ambient temperature is within the recommended ambient temperature set forth in the specifications for such product.
- i) Defects caused by normal wear and tear or otherwise due to normal aging of a product.

The warranty does not apply to any product where the serial number has been removed or obliterated. The warranty also does not apply to any product sold by a reseller to an end user outside of the country where the reseller is located unless (i) Christie has an office in the country where the end user is located or (ii) the required international warranty fee has been paid.

The warranty does not obligate Christie to provide any on-site warranty service at the product site location.

PREVENTATIVE MAINTENANCE

Preventative maintenance is an important part of the continued and proper operation of your product. Please see the Maintenance section for specific maintenance items as they relate to your product. Failure to perform maintenance as required, and in accordance with the maintenance schedule specified by Christie, will void the warranty.

REGULATORY (if applicable)

The product has been tested and found to comply with the limits for a Class A digital device, pursuant to Part 15 of the FCC Rules. These limits are designed to provide reasonable protection against harmful interference when the product is operated in a commercial environment. The product generates, uses, and can radiate radio frequency energy and, if not installed and used in accordance with the instruction manual, may cause harmful interference to radio communications. Operation of the product in a residential area is likely to cause harmful interference in which case the user will be required to correct the interference at the user's own expense.

CAN ICES-3 (A) / NMB-3 (A)

이 기기는 업무용(A급)으로 전자파적합등록을 한 기기이오니 판매자 또는 사용자는 이점을 주의하시기 바라며, 가정 외의 지역에서 사용하는 것을 목적으로 합니다.

ENVIRONMENTAL

The product is designed and manufactured with high-quality materials and components that can be recycled and reused. This symbol



means that electrical and electronic equipment, at their end-of-life, should be disposed of separately from regular waste. Please dispose of the product appropriately and according to local regulations. In the European Union, there are separate collection systems for used electrical and electronic products. Please help us to conserve the environment we live in!

China RoHS Compliance Information

关于中国《电子信息产品污染控制管理办法》的说明

- Environmentally Friendly Use Period

环保使用期限



The year number in the centre of the label indicates the Environmentally Friendly Use Period, which is required to mark on the electronic information product sold in China according to the China RoHS regulations.

本标志中表示的年数是根据《电子信息产品污染控制管理办法》（2006年2月28日）以及《电子信息产品污染控制标识要求》（2006年11月6日）制定的、适用于在中华人民共和国境内销售的电子信息产品的环保使用期限

- Material Concentration Values Table

有毒有害物质含量表

Part Name	部件名称	Material Concentration (有毒有害物质或元素)					
		铅 (Pb)	汞 (Hg)	镉 (Cd)	六价铬 (Cr 6+)	多溴联苯 (PBB)	多溴二联苯醚 (PBDE)
Audio/Video input PCB	音影输入卡	X	O	O	O	O	O
System board PCB	主板	X	O	O	O	O	O
Mechanical enclosure*	机械附件	X	O	O	O	O	O
<p>Note:</p> <p>O: indicates that the concentration value of the particular hazardous substance contained in all the homogeneous materials for this part, according to EIP-A, EIP-B, EIP-C, is below the stipulated levels in China SJ/T11363-2006.</p> <p>表示该有毒有害物质在该部件所有均质材料中的含量均在SJ/T11363-2006规定的限量要求以下。</p> <p>X: indicates that the concentration value of the particular hazardous substance contained in all the homogeneous materials for this part, according to EIP-A, EIP-B, EIP-C, may be above the stipulated levels in China SJ/T11363-2006.</p> <p>表示该有毒有害物质至少在该部件的某一均质材料中的含量可能超出SJ/T11363-2006规定的限量要求。</p>							
<p>* This part uses metallic alloys, which may contain Lead. 因该部件使用金属合金材料，故可能含有铅。</p>							

Contents

Welcome to the Phoenix System	13
Technical Support	13
About this Document	13
Document Conventions	13
Scope	13
Audience	14
Prerequisites	14
Reference and Related Documents.....	14
Introduction	15
Safety Precautions	15
SBC Battery Warning	15
Service Warning	15
Class I Construction Warning	15
Labeling Glossary	15
End-of-Life Disposal.....	15
Planning	16
Display Wall Specifications	16
Power	16
Installation Rack Placement.....	16
Mounting Methods	17
Environmental Conditions.....	17
Physical Specifications	17
Network Switch.....	17
Network Streaming Devices.....	18
Cabling	18
Ethernet Cabling	18
DVI Cabling	18
System Overview	19
Node Roles.....	20
Node Modes.....	21
Loop-Through Mode.....	21
Interaction Mode	21

Getting Started22

Install the Phoenix Processor Hardware23

 Tools, Equipment, and Service Materials23

 Install Kit23

 Cable and Power Connections and Status LED24

 Installation Sequence28

 Mounting the Nodes.....29

 How to Mount the Nodes in a Rack29

 How to Mount a Node under a Desk30

 How to Mount a Node behind a Monitor30

 Networking.....32

 How to Connect the Nodes to a Network.....33

 Connect Sources to the Phoenix System.....33

 How to Connect Encoding Sources to the Network33

 How to Connect DVI Output Capable Devices33

 How to Connect Displays for the Walls35

 How to Connect Power to the Nodes37

 Connect a Management Computer to the Phoenix System38

 Computer Requirements.....38

Configure a Controller.....39

 How to Start the Controller Manager Wizard39

 How to Assign a Node as the Controller.....40

 How to Deactivate a Controller.....42

 How to Update a Controller43

Web Manager45

 Supported Browsers45

 Access the Web Manager.....45

 Installing the Security Certificate.....45

 Logging in to the Web Manager48

 How to Sign in to the Web Manager48

 Web Manager Main Menu.....51

 Manage Sources.....53

 How to View a Source List53

 How to Add a Source54

 How to Create Titling Overrides.....77

 How to View a Source Profile78

How to Edit a Source	78
How to Bulk Edit Sources.....	79
How to Delete a Source.....	80
Manage Nodes	81
How to View a Node Profile	82
How to Add a Node.....	85
How to Download the Details for the Nodes	86
How to Edit a Node.....	87
How to Un-assign a Node	89
How to Stop Decoding on a Node	89
Manage Walls	90
How to View a Wall Profile	90
How to Add a Wall.....	92
How to Implement Subwalls	96
How to Edit a Wall.....	102
How to Bulk Edit Walls	104
How to Apply Test Patterns.....	104
Manage Users	105
How to View a User Profile.....	107
How to Add a User.....	107
How to Edit a User Profile	109
How to Change a Password.....	109
How to Unlock a User Account.....	110
How to Force Users to Logout	111
How to Change the Default Password.....	112
How to Delete a User	112
Update Global System Settings	113
Manage System Settings	113
Directory Services	127
Manage EDID Configurations.....	135
Using the Protocol Tester.....	136
Using the JSON API Tester.....	136
How to Connect to a Milestone Server.....	137
How to Map Milestone Events to Phoenix Wall Layouts	138
How to Add a Virtual Machine	138
Phoenix Quick Control	140

Accessing Phoenix Quick Control	140
Supported devices.....	140
Select preferences.....	140
Selecting a wall.....	141
Swapping a source on a layout.....	141
Applying a treatment to a source	141
Desktop Client	142
Install the Desktop Client	144
How to Install Visual Studio 2012 Update	144
How to Install the Desktop Client Software	144
Starting the Desktop Client the First Time	146
Start the Desktop Client.....	147
How to Start the Desktop Client	147
Phoenix Desktop Client Settings.....	149
How to Change the Desktop Client Settings	149
How to Remember the Last Workspace	149
How to Enable Desktop Drag and Drop.....	150
Sources List.....	150
How to Open a Source	151
How to Use the Source Viewer	152
How to Reset the Decoder Network Streams.....	154
How to Refresh a Thumbnail	154
How to View a Source in the Web Manager	154
How to Add a Source to Favorites.....	154
How to Add a Message to a Source	154
How to Clear a Message from a Source	155
How to Delete a Source Folder Groups	156
Walls List	157
Layouts List.....	157
How to Create a Wall Layout.....	159
How to Delete Layout Folder Groups	160
How to Rename a Layout.....	160
How to Apply a Layout to another Wall.....	161
Treatments List.....	161
How to Create a Treatment.....	161
How to Apply a Treatment to a Source	162

How to Clear a Source Treatment	163
Favorites List	163
How to Add an Item to Favorites	163
Users List	163
How to Manage Users	164
Wall Simulator	165
Working with Subwalls	165
How to Add a Source to a Wall	165
How to Remove a Source from a Wall	166
How to View a Source on your Desktop	166
Wall Tab.....	166
How to Add a Layout to a Group.....	167
How to Edit a Wall in Preview Mode	168
Simulator Tab	168
Window Tab.....	170
Source Tab	171
Test Pattern Tab.....	171
Change the Controller.....	172
Using Workspaces and Settings.....	172
How to Save a Desktop Workspace.....	172
How to Open a Saved Workspace	173
Changing the Settings.....	173
Configure Audio for a Wall.....	174
Interaction Mode.....	176
Direct Interaction	177
Interaction using Desktop Client	177
Periodic Maintenance.....	178
Maintenance Schedule	178
Glossary	179
Appendix A - Ports used by the Phoenix System.....	181
Appendix B - Phoenix System Specifications.....	183
Appendix C - Qualified Christie Video Wall Panels for Phoenix EP	185
Appendix D - Configuration Worksheet.....	186
Appendix E - Tips.....	189
Quick Facts	189
Change the Cursor Shape for VNC Sources	189

Index 191

Figures

Figure 1 - Front View 24

Figure 2 – Rear View Version 1 24

Figure 3 – Back View Version 2 26

Figure 4 – Physical Connections 28

Figure 5 - Rack Mounting Brackets 29

Figure 6 - Under Desk Mounting Brackets 30

Figure 7 – VESA 1 Mounting Brackets 31

Figure 8 – VESA 2 Mounting Brackets 32

Figure 9 - Connections for Interaction 35

Figure 10 - Synchronizing Nodes 36

Figure 11 – Sign In Page 49

Figure 12 – Home Page 52

Figure 13 - Status 53

Figure 14 – Source List 54

Figure 15 – Add Phoenix DVI Input Source 55

Figure 16 – Add RTSP Stream Source 58

Figure 17 - Add VNC Source 66

Figure 18 – Adding a Remote Desktop Source 71

Figure 19 – Add Still Source 74

Figure 20 – Add Application Source 75

Figure 21 - Titling Overrides 77

Figure 22 – Node List 81

Figure 23 – Node Profile 82

Figure 24 – System Settings 116

Figure 25 – Software Versioning Fields 116

Figure 26 – Wall Simulator and Sources List, Not Docked 143

Figure 27 - All Lists Opened and Docked 143

Figure 28 – Audio Connections 175

Tables

Table 1 — Symbols 15

Table 2 — Install Kit Contents23

Table 3 — Power and Cable Connectors Version 125

Table 4 — Power and Cable Connectors Version 226

Table 5 — Installation Tasks28

Table 6 — Phoenix DVI Input Fields56

Table 7 — RTSP Fields59

Table 8 — VNC Fields66

Table 9 — Remote Desktop Fields72

Table 10 — Still Fields74

Table 11 — Application Source Fields76

Table 12 — Titling Overrides78

Table **13** — Node Fields82

Table 14 — Wall Fields95

Table 15 — Software Versioning116

Table 16 — Active Directory Credentials134

Table 17 — Virtual Machine Fields139

Table **18** — Recommended Maintenance178

Welcome to the Phoenix System

Phoenix is a network-based open content management system that lets all users encode, access, and control audio-visual data securely from anywhere, at any time via standard IP networking technology. Multiple users, in multiple locations anywhere in the world can share and interact with control room information from virtually any device.

The Phoenix system consists of one or many Phoenix hardware nodes as well as software connected through your Ethernet network.

Technical Support

For support for this product, visit:

<http://www.christiedigital.com/en-us/product-support/support-offices/Pages/default.aspx>

About this Document

This manual provides instructions for installing, configuring, and maintaining the Phoenix system. The instructions assume the user is adequately familiar with the intended use of this equipment and is familiar with basic required installation skills and knowledge of local and accepted safety practices.



The procedures in this document assume a certain level of knowledge of electronics and safety guidelines.

Document Conventions

The following format conventions are used in this document to identify special information:

Warning statements identify conditions or practices that could result in personal injury.

Caution statements identify conditions or practices that could result in damage to equipment or loss of data.



The graphical illustrations in this document are for example purposes only and the hardware illustrated may differ from your hardware.

Variable text that is entered by a user is italicized in this document (for example, in the text, *6-digit serial number*, the 6-digit serial number would be replaced by the actual serial number).

Scope

This document focuses on the hardware installation and use of the Phoenix system.

Audience

The primary audience for this document is the person who installs the system and the users of the interfaces.

Prerequisites

Only trained and qualified personnel should install the Phoenix system. The people performing these tasks should have the following skills and prerequisite knowledge, or work closely with others who have these skills:

- Users assigned “administrator” roles must have a comprehensive knowledge of networking
- Users assigned “user” roles must be familiar with networking
- Familiarity with video equipment
- Basic electronic skills

Reference and Related Documents

The following documents may be useful references:

- Phoenix System Quick Start Guide (020-101184)
- Phoenix System External Control Protocol Reference Manual (020-101425)
- Phoenix System External Control Protocol JSON Reference Manual (020-000965)
- Phoenix Release Notes (020-101254)
- Installing Phoenix EP (020-102421)
-

Introduction

This section covers the safety precautions, labeling, symbols, and product compliance.

Safety Precautions

This section discusses the safety precautions for the Phoenix system.

SBC Battery Warning

The battery in Phoenix system is not intended to be replaced by the user. Failure to follow these instructions will void the warranty of the unit.

There is danger of explosion if battery is incorrectly replaced.

Replace only with the same or equivalent type of battery.

Service Warning



The unit has no field-serviceable parts. The enclosure surrounding the unit should not be removed. Failure to follow these instructions may void the warranty.

Class I Construction Warning

An apparatus with Class I construction shall be connected to a MAINS socket outlet with a protective earthing connection.

Labeling Glossary

Table 1 – Symbols

	<p>This symbol indicates the hardware is RoHS compliant.</p>		<p>These symbols warn where potentially hazardous voltages exist.</p>
---	--	---	---

End-of-Life Disposal

Please properly recycle the Phoenix system when it is permanently removed from service. This product has been designed such that a large percentage of the product material can be recycled. Please follow local and/or national regulations regarding disposal of electronics equipment.

Planning

When planning to install a Phoenix system, consider the following:

- The number of nodes required.
- Power availability for the nodes, Ethernet switch, and encoding and decoding sources.
- Rack size (if rack mounted).
- Mounting methods.
- Environmental conditions for the installation site.
- Space availability for the equipment.
- Cabling distances between the location of the Phoenix nodes and the connected devices and supported display walls.
- Ethernet switch capabilities.

Display Wall Specifications

The following are considerations when planning your wall designs:

- One wall can support a maximum of 128 DVI outputs; consisting of up to 64 nodes using dual outputs, or up to 128 nodes using single outputs.
- The maximum display resolution supported is 2560 x 1600 pixels.
- All outputs on a single wall have to be set to the same resolution.

Power

Each node has a separate power cord. Only use the power cord supplied with the equipment.

Continuous power and network connectivity must be available to the equipment.

Installation Rack Placement

The Phoenix nodes mount in a standard 19-inch equipment rack. These racks are available in various heights and depths.

When determining the spacing needed for the rack, consider the following:

- Ensure there is enough space around the rack to ensure airflow (around the unit and through the vents) is unrestricted.
- The rack should not be located near water or heat sources.
- Clearance around the equipment should be sufficient to view the status LED in the front of the nodes and to connect cabling to the back of the nodes.
- The environment should be as free from dust as possible.

Mounting Methods

The Phoenix nodes can be mounted in a 19-inch equipment rack. These racks are readily available. Optionally, the nodes can be mounted under a desk, using a desk mounting bracket; or behind a monitor, using a monitor mounting bracket. These brackets can be ordered with your Phoenix nodes.

Regardless of the mounting method used, the units must be secured with thermal isolation between units. When mounting the units in a vertical position, make sure to align the fan direction with rising heat (front panel facing downward).

Environmental Conditions

The equipment should be located in a controlled environment. The site should be controlled to adhere to the following conditions:

- Operating temperature range: 0°C to 40°C (32°F to 104°F)
- Storage temperature: -20°C to 60°C (-4°F to 140°F)
- Relative humidity: 10-85% non-condensing
- Operating altitude: maximum of 2000 m (6562 ft) above sea level
- The equipment should be installed in a dust-free environment.

Physical Specifications

The Phoenix node is a 1U rack-mountable device with the following specifications:

- Dimensions (W x H x D): 17.40" (44.2 cm) x 1.74" (4.4 cm) x 9.5" (24.1 cm)
- Weight: 6.5 lbs

Network Switch

The network switch must be a managed 10/100/1000 Gigabit network switch and must be capable of performing Layer 2 or Layer 3 functions including:

- IP multicasting
- Internet Group Management Protocol (IGMP), version 2 only
- IGMP querier must be turned on
- Protocol Independent Multicast (PIM), Sparse Mode (PIM-SM)
- Power over Ethernet (PoE) (optional)



If your network uses multiple switches, PIM-SM must be enabled.

Multicasting allows one network device to send content to multiple devices that have identified themselves as interested in receiving content from that device.

IGMP is the protocol that manages the multicasting to the group of devices that have subscribed to receive content. It restricts multicasting to the devices that subscribe to the group.

PIM is used to communicate with other switches on the network that have subscribed to receive the content. Sparse mode provides more precise control because content only goes where needed.

PoE is used to power LAN devices. It supports standards-based IEEE 802.3af PoE devices such as IP cameras.

Network Streaming Devices

All networking streaming devices must support Real Time Streaming Protocol (RTSP) with H.264 video (also known as Advanced Video Coding (AVC), MPEG-4 AVC, or MPEG-4 Part 10).

Cabling

The Phoenix node features a DVI-I receptacle connector that mates any type of DVI cable connectors, including DVI-A, DVI-D and DVI-I. However, a Phoenix node only supports DVI Digital signals and the analog pins are unconnected. The DVI-I receptacles are provided for the purpose of convenience only. The Phoenix node does not accept any analog video signals and a passive VGA-to-DVI adapter will not work.

The Ethernet connections use Cat6 (Cat6a recommended) cables with standard RJ45 connectors.

The audio connectors on the Phoenix node use standard 3.5 mm (miniature or 1/8 inch) connectors. Make sure to have the required cabling available.

Ethernet Cabling

Ethernet cabling lengths from the connected devices to the Ethernet switch should be no longer than 100 m (328 ft).

DVI Cabling

The Phoenix system inputs and outputs conform to the VESA standard for DVI-D signaling and can support various cable lengths depending on the quality of the cable used. Installations using long-running cables should consider using active (amplified) solutions, including the use of Cat6 (Cat6a recommended) or fiber extension.



Signal amplifiers must be used when the cables on the Phoenix DVI inputs are longer than 15 feet.

The Phoenix system requires full support of EDID (Extended Display Identification Data) to operate properly.

System Overview

The Phoenix system is a content management system that enables users to access and control audio-visual data, securely and reliably from anywhere at any time, via standard IP networking technology. The Phoenix-managed content is distributed throughout an organization via standard IP networking technology, providing comprehensive tools to view, listen, and interact with any source or information. The Phoenix system consists of one or many Phoenix hardware nodes as well as software connected through your Ethernet network.

When the Phoenix nodes are on the same network, they interact with one controller. The controller operates as the central point for configuration and monitoring of all the nodes.

Based on the H.264 industry standard for media encoding and decoding, Phoenix nodes integrate seamlessly into existing IT environments, automatically recognizing each other and organizing to create an easily configured collaboration resource.

A uniquely modular system, the Phoenix system is easy to configure and deploy. The Phoenix system has the following user interfaces:

- Phoenix Controller Management Wizard
- Phoenix Web Manager
- Phoenix Desktop Client
- Phoenix Quick Control

The Controller Management Wizard is used by administrators to assign a controller for a node or a cluster of nodes (refer to [Configure a Controller](#), page 39). The Web Manager is Web-based software used by administrators to configure the system (refer to [Web Manager](#), page 45). The Desktop Client is installed on a PC and is used to design the wall content (refer to [Desktop Client](#), page 142). The Web Manager and the Desktop Client interact with the same controller to share resources (e.g., user profiles, sources, nodes, etc.). Administrators have access to both the Web Manager and the Desktop Client. Users (with user roles) can only access the Desktop Client (refer to [Manage Users](#), page 105). The Phoenix Quick Control app is used to recall layouts and change sources (refer to [Phoenix Quick Control](#), page 140).

The Phoenix system has two types of nodes: the Phoenix Processor and the Phoenix Embedded Processor (EP). The Phoenix Processor is usually rack mounted, while the EP is installed directly into Christie-compatible displays. The differences between a Phoenix Processor and a Phoenix EP are illustrated below:

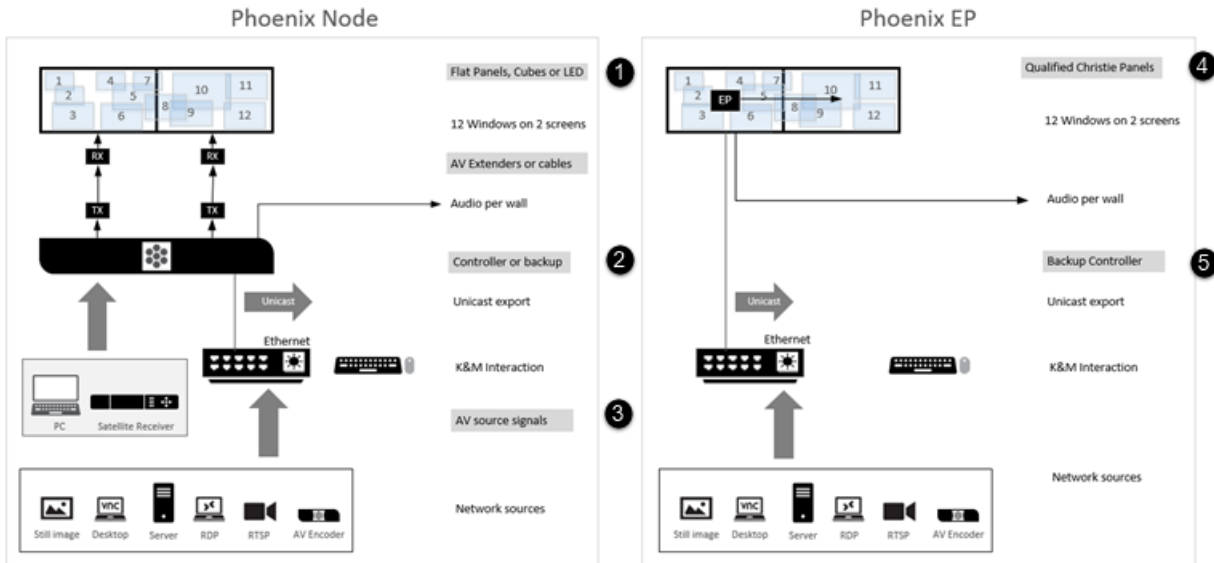

Legend

	Phoenix Processor	EP
Display Compatibility	1	4
Controller Functionality	2	5
AV inputs DVI and audio	3	-

Node Roles

Each node can perform one or more roles. These roles include:

- Controller
- Encoder/Transcoder
- Decoder

The system monitors the utilization for each role the node performs. One node must serve as the controller and manage the system data and status for all the nodes on the network including the following:

- Maintains a listing of IP and MAC addresses for all nodes discovered on the network.
- Stores all system configuration data as a set of XML files and shares this data with the other nodes.

One or more nodes perform the encoder/transcoder (input) role. When performing this role, the node converts a live DVI input into an H.264 encoded data stream and transmits it via Ethernet to the appropriate Phoenix nodes. Transcoding is used for Virtual Network Connection (VNC) and Remote Desktop Protocol (RDP) sources.

One or more nodes perform the decoder (output) role. When performing this role, the node decodes multiple H.264 streams, adds treatments and effects, resizes and composites in real time and outputs on the displays connected to the output connectors (Output A and Output B).

A single Phoenix node can be an encoder, decoder, and controller all at the same time.

Any node can assume the controller role if the current controller fails. If this happens and the Controller Redundancy option is activated, one of the nodes connected to the controller automatically assumes the controller role.

Node Modes

The following modes are supported:

- Loop-Through
- Interaction

Loop-Through Mode

A Phoenix node is capable of providing loop-through of a DVI source at its outputs. This mode applies to nodes that are configured as Encoders only. While the node performs encoding/transcoding functionality, each DVI output displays the content available at its corresponding input. However, the source connected to the Input A connector is considered to be the primary input; and if the source connected to the Input B connector has a different resolution compared to the source connected to Input A, the output connected to the Output B connector will fail to function in loop-through mode. If it is not intended to have different resolutions at each of the DVI inputs, the EDID configuration at the Phoenix DVI inputs may be manipulated using the EDID Manager in the Phoenix Web Manager.

Interaction Mode

Interaction Mode enables you to interact with a wall or a source on a wall (refer to [Interaction Mode](#), page 176) for additional information).

Getting Started

To get started quickly, refer to the Phoenix System Quick Start Guide. This guide is available on the flash drive that was shipped with the system and on the customer download site.

Install the Phoenix Processor Hardware

This section covers installing the Phoenix Processor. Refer to the *Installing Phoenix EP* (part number: 020-102421-01) for instructions on installing the Phoenix EP into Christie-compatible display.

The Phoenix hardware should be installed in a controlled environment (refer to *Environmental Conditions*, page 17).

Tools, Equipment, and Service Materials

The following items may need to be available during installation and are not supplied with the system:

- ✓ Ethernet management cabling
- ✓ DVI cabling
- ✓ RJ45 connectors and cables
- ✓ Standard hand tool set
- ✓ Cable ties and/or lacing cords
- ✓ Labels
- ✓ Computer for provisioning
- ✓ Speakers
- ✓ Audio cables

Install Kit

The install kit is shipped with the Phoenix system and it contains the following items:

Table 2 — Install Kit Contents	
Description	Quantity
USB-A to Mini B (1.8m) cable Used to connect a Phoenix node to an input source device to interact with the device.	2
10-32 x ¾ screws Used to attach the unit to the equipment rack.	4
8-32 x 3/8 screws Used to attach the unit to the rack mounting bracket (ears).	4
Rack mounting brackets (ears) Used to attach the unit to the rack.	2

Table 2 — Install Kit Contents	
Description	Quantity
Power cord Used to apply power to the unit.	1
USB flash drive Used to install the Phoenix Controller Manager wizard and to access the documentation.	1
Feet Self-adhesive non-skid rounds, applied when unit is not mounted (strip of 4).	1

Cable and Power Connections and Status LED

All of the connections for the Phoenix Processor are on the back of the unit. The connectors differ for the two hardware versions. The differences are noted in this section.

The front of the unit has a status LED.

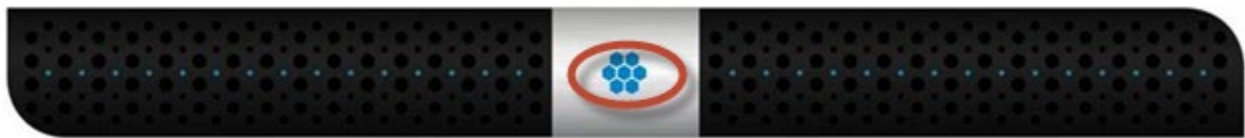

Figure 1 - Front View

When the LED indicator on the front of the node is solid blue, the node is ready. The LED flashes when the unit is powering on. When the LED is yellow or red, a problem has been detected. When the LED is yellow, one or more warning alerts have been detected on the node. When the LED is red, one or more critical alerts have been detected on the node. View the related node profile in the Web Manager to determine the source of the problem.



All connections to the unit should be connected before starting the Web Manager or Desktop Client.



- 1 Ethernet 1
- 2 DVI Monitor
- 3 Optical Audio Input
- 4 Audio Input A
- 5 DVI Input A
- 6 DVI Input B
- 7 Network Sync Input
- 8 USB (x2)
- 9 Optical Audio B
- 10 Audio Input B
- 11 Audio Output
- 12 Ethernet 2
- 13 KVM A
- 14 KVM B
- 15 DVI Output A
- 16 DVI Output B
- 17 Network Sync Output

Figure 2 – Rear View Version 1

The connectors for hardware version 1 include the following:















Table 3 — Power and Cable Connectors Version 1															
Callout	Connector	Label	Graphic	Usage											
	Pushbutton Power Switch			Powers the unit on or off.											
	Power Cord Connector	None		Connects the unit to a power source.											
1	1000BASE-T Ethernet Connector	Network 1		Connects the Phoenix system to a network. The left LED is an activity LED that blinks green (version 1 hardware) or blinks orange (version 2 hardware) when there is Ethernet activity. The right LED is a connection speed indicator that is solid green for 100 Mbps, solid yellow for 1 Gbps, and is off for no connection.											
8	Dual USB Connectors	1  2 		Connects USB-compatible devices to the unit for troubleshooting the node when working with support personnel, or when directly interacting with the unit.											
2	DVI-I Dual Video Female Connectors (blue)	None		Connects a display monitor to the unit for troubleshooting the node when working with support personnel. Otherwise, this connector should not be used.											
3, 4, 9, 10, 11	Audio Connectors	In A (1 black, 1 blue) Line Out (1 orange, 1 green) In B (1 pink)		<p>Connects audio to the unit.</p> <table border="1"> <tr> <td>Black In A</td> <td>Currently not used.</td> </tr> <tr> <td>Blue In A</td> <td>Encodes the audio for the source connected to the Input A connector on the unit.</td> </tr> <tr> <td>Orange Line Out</td> <td>Currently not used.</td> </tr> <tr> <td>Green Line Out</td> <td>Decodes and plays audio from one of the sources connected to the Output A or B connectors on the unit.</td> </tr> <tr> <td>Pink In B</td> <td>Encodes the audio for the source connected to the Input B connector.</td> </tr> </table>		Black In A	Currently not used.	Blue In A	Encodes the audio for the source connected to the Input A connector on the unit.	Orange Line Out	Currently not used.	Green Line Out	Decodes and plays audio from one of the sources connected to the Output A or B connectors on the unit.	Pink In B	Encodes the audio for the source connected to the Input B connector.
Black In A	Currently not used.														
Blue In A	Encodes the audio for the source connected to the Input A connector on the unit.														
Orange Line Out	Currently not used.														
Green Line Out	Decodes and plays audio from one of the sources connected to the Output A or B connectors on the unit.														
Pink In B	Encodes the audio for the source connected to the Input B connector.														
12	1000BASE-T Ethernet Connector	Network 2		Currently not used. Reserved for future use.											
13, 14	Dual USB Mini Connectors	KVM A KVM B		Used to interact with a Phoenix DVI input source that is connected to the node. One end connects to the device running the source and the other end connects to the corresponding KVM port (for example, if the device is connected to Input A, the other end connects to KVM A).											
5, 6	Dual DVI-I Video Female Connectors	Input A and B		Connects Phoenix DVI Input sources to the unit for encoding.											

Table 3 — Power and Cable Connectors Version 1				
Callout	Connector	Label	Graphic	Usage
15, 16	Dual DVI-I Video Female Connectors	Output A and B		Connects displays for decoding.
7, 17	RJ45 Connectors	Sync In Sync Out		Interconnects all the nodes in a wall so all output would be synchronized and the content being displayed across a node boundary would remain synchronized. <div style="display: flex; align-items: center;">  <p>These connectors are used for proprietary signaling. Do not use these connectors to connect to a network. Doing so could damage either the Phoenix system or any other equipment attached to the network.</p> </div>

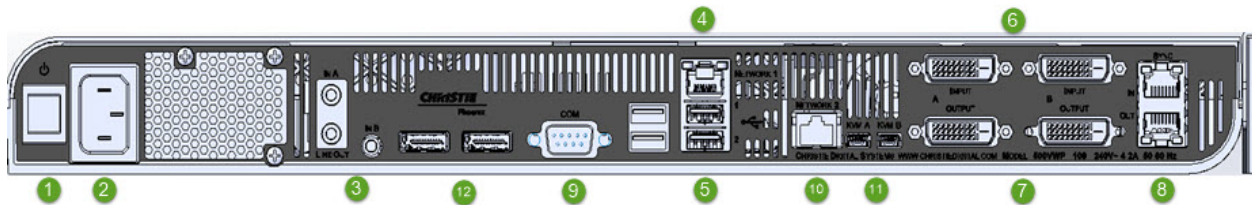

Figure 3 – Back View Version 2

The connectors for hardware version 2 include the following:

















Table 4 — Power and Cable Connectors Version 2				
Callout	Connector	Label	Graphic	Usage
1	Pushbutton Power Switch			Powers the unit on or off.
2	Power Cord Connector	None		Connects the unit to a power source.
3	Audio Connectors	In A (blue) Line Out (green) In B (pink)		Blue In A Encodes the audio for the source connected to the Input A connector on the unit.
				Green Line Out Decodes and plays audio from one of the sources connected to the Output A or B connectors on the unit.
				Pink In B Encodes the audio for the source connected to the Input B connector.
4	1000BASE-T Ethernet Connector	Network 1		Connects the Phoenix system to a network. The left LED is an activity LED that blinks green when there is Ethernet activity. The right LED is a connection speed indicator that is solid green for 100 Mbps, solid yellow for 1 Gbps, and is off for no connection.

Table 4 – Power and Cable Connectors Version 2

Callout	Connector	Label	Graphic	Usage
5	Dual USB Connectors	1  2 		Connects USB-compatible devices to the unit for troubleshooting the node when working with support personnel, or when directly interacting with the unit.
9	COM Connector	COM		Used to communicate with API commands. Refer to How to Set the Communication Method for the API Connection , page 120.
12	DisplayPort	None		Connects a display monitor to the unit for troubleshooting the node when working with support personnel. Otherwise, this connector should not be used.
10	1000BASE-T Ethernet Connector	Network 2		Currently not used. Reserved for future use.
11	Dual USB Mini Connectors	KVM A KVM B		Used to interact with a Phoenix DVI input source that is connected to the node. One end connects to the device running the source and the other end connects to the corresponding KVM port (for example, if the device is connected to Input A, the other end connects to KVM A).
6	Dual DVI-I Video Female Connectors	Input A and B		Connects Phoenix DVI Input sources to the unit for encoding.
7	Dual DVI-I Video Female Connectors	Output A and B		Connects displays for decoding.
8	RJ45 Connectors	Sync In Sync Out		Interconnects all the nodes in a wall so all output would be synchronized and the content being displayed across a node boundary would remain synchronized.  These connectors are used for proprietary signaling. Do not use these connectors to connect to a network. Doing so could damage either the Phoenix system or any other equipment attached to the network.

The following example illustrates the physical connections for a deployment of multiple nodes and sources:

- Node connects to the network through the Network 1 connector.
- Phoenix DVI Input sources connect to Input A or B connectors on any node.
- Displays for walls connect to the Output A or B connectors on any node.
- RTSP Streams, VNC, Remote Desktop, and Still sources connect to the network.
- Administration PC connects to the network.

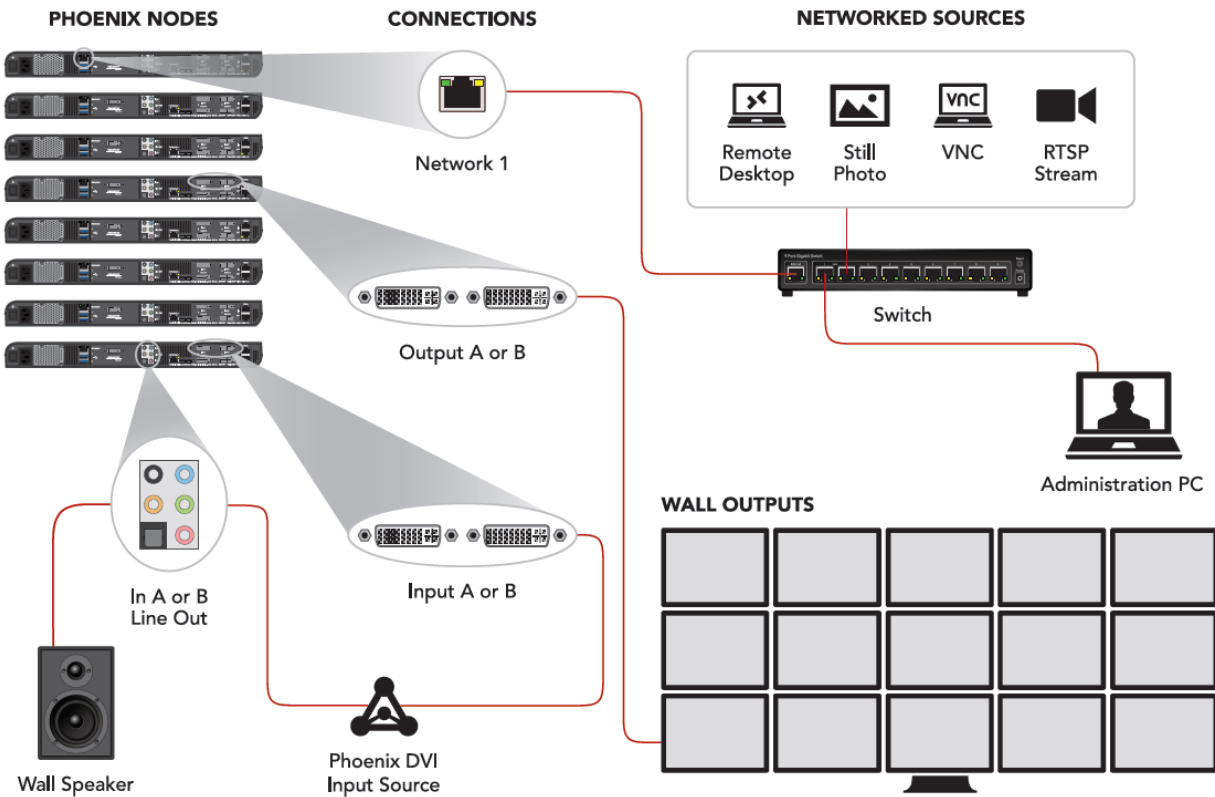

Figure 4 – Physical Connections

Installation Sequence

Perform the installation tasks using the following sequence:

Table 5 – Installation Tasks	
Task	Reference
1. Mount the node(s) in the desired location.	Mounting the Nodes , page 29
2. Connect the power cables.	How to Connect Power to the Nodes , page 37
3. Connect an administration PC to the network.	Connect a Management Computer to the Phoenix System , page 38
4. Connect the node(s) to the Ethernet network.	How to Connect the Nodes to a Network , page 33
5. Connect the encoding sources to the network.	How to Connect Encoding Sources to the Network , page 33
6. Connect the Phoenix DVI Input sources to the input connectors on the Phoenix unit.	How to Connect DVI Output Capable Devices , page 33
7. Connect the decoding sources to the output connectors on the Phoenix unit.	How to Connect Displays for the Walls , page 35

Table 5 – Installation Tasks	
Task	Reference
8. To support audio on a wall, connect an audio source to the wall.	Configure Audio for a Wall , page 174
9. Synchronize the display wall output.	How to Synchronize the Display Wall , page 35

Mounting the Nodes

The nodes can be rack mounted, desk mounted, or mounted behind a monitor.



Regardless of the mounting method chosen, care should be taken to ensure that airflow is unobstructed at the front and back of the shelf. Air flows from the bottom front to the rear top.

How to Mount the Nodes in a Rack

Tools and equipment required: screws (provided), rack mounting bracket (provided), and standard tool kit.

The nodes can be mounted in a standard 19-inch equipment rack using the mounting brackets (ears) and screws provided in the install kit. This is the standard mounting option and can be used to mount more than one node in a rack.

To mount the equipment in a rack:

1. Attach the rack mounting brackets to the node using the 4 small screws (8-32 x 3/8) from the install kit.

1. Rack mounting bracket	2. 8-32 x 3/8 screw	3. Phoenix node
--------------------------	---------------------	-----------------

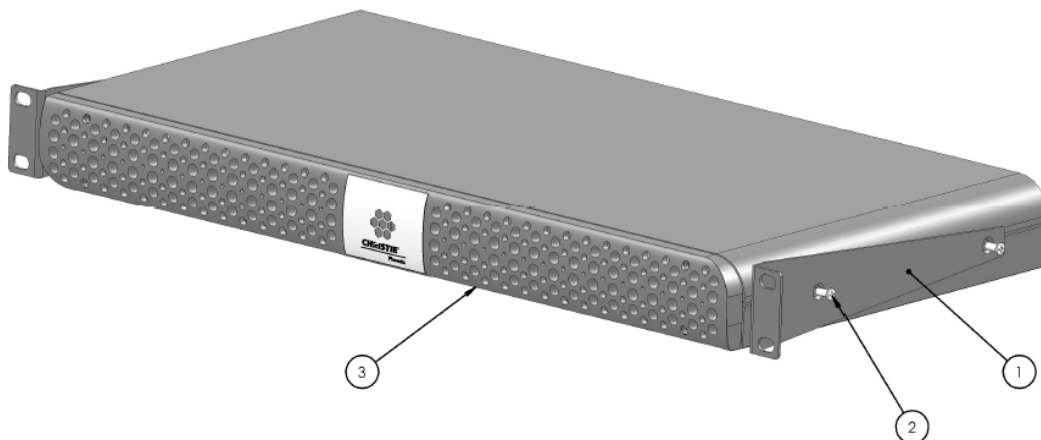

Figure 5 - Rack Mounting Brackets

2. Attach the rack mounting brackets to the rack rails using the four large screws (10-32 x 3/4) from the install kit.
3. Install additional units following the above steps.

How to Mount a Node under a Desk

Tools and equipment required: screws (provided in optional bracket kit), mounting brackets (provided in optional bracket kit), and standard tool kit.

The nodes can be mounted under a desk or other flat surface using the optional Under-Desk bracket kit.

To mount the equipment under a desk:

1. Attach the mounting brackets to the node using the 4 small screws (8-32 x 3/8) provided in the kit.

1. Rack Ear	2. 8-32 x 3/8 screw	3. Phoenix node
-------------	---------------------	-----------------

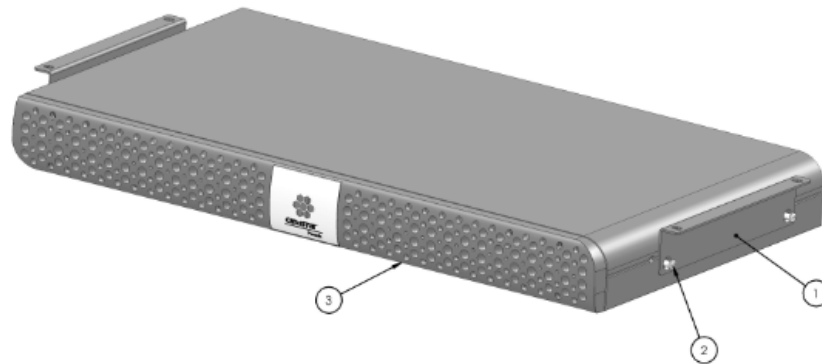

Figure 6 - Under Desk Mounting Brackets

2. Attach the mounting brackets to the underside of the desk using the appropriate hardware.

How to Mount a Node behind a Monitor

Tools and equipment required: screws (provided in optional bracket kit), mounting brackets (provided in optional bracket kit), and standard tool kit.

The nodes can be mounted behind a monitor using the optional VESA 1 or VESA 2 bracket kit.

How to Mount a Node using the VESA 1 Kit

To mount the equipment using the VESA 1 kit:

1. Attach the bracket to the node using the 4 small screws (8-32 x 3/8) provided with the brackets.

1. Monitor, 100 mm or 200 mm mounting	2. Mounting bracket
3. 8-32 x 3/8 screw	4. Phoenix node

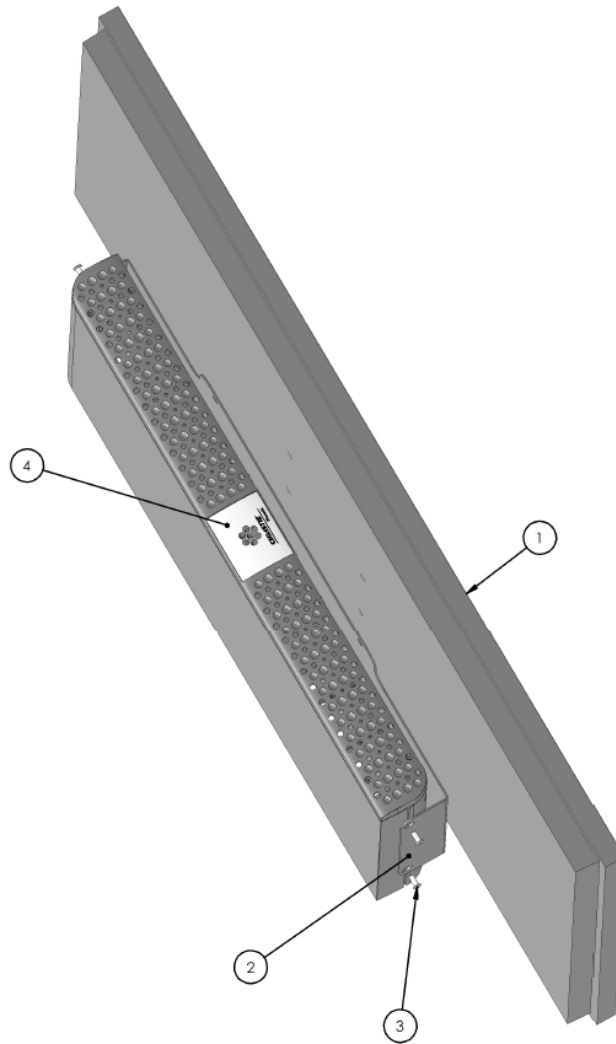

Figure 7 – VESA 1 Mounting Brackets

2. Attach the bracket to the monitor using the appropriate hardware.



You can re-use the screws that secured the monitor stand.

How to Mount a Node using the VESA 2 Kit

To mount the equipment using the VESA 2 kit:

1. Attach the bracket to the monitor using the stand mounting screws.
2. Attach the bracket to the monitor stand using the appropriate hardware.

1. Monitor stand	2. Monitor, 100 mm or 200 mm mounting	3. VESA 2 bracket
4. 8-32 x 3/8 screw	5. Stand mounting screw	6. Phoenix node

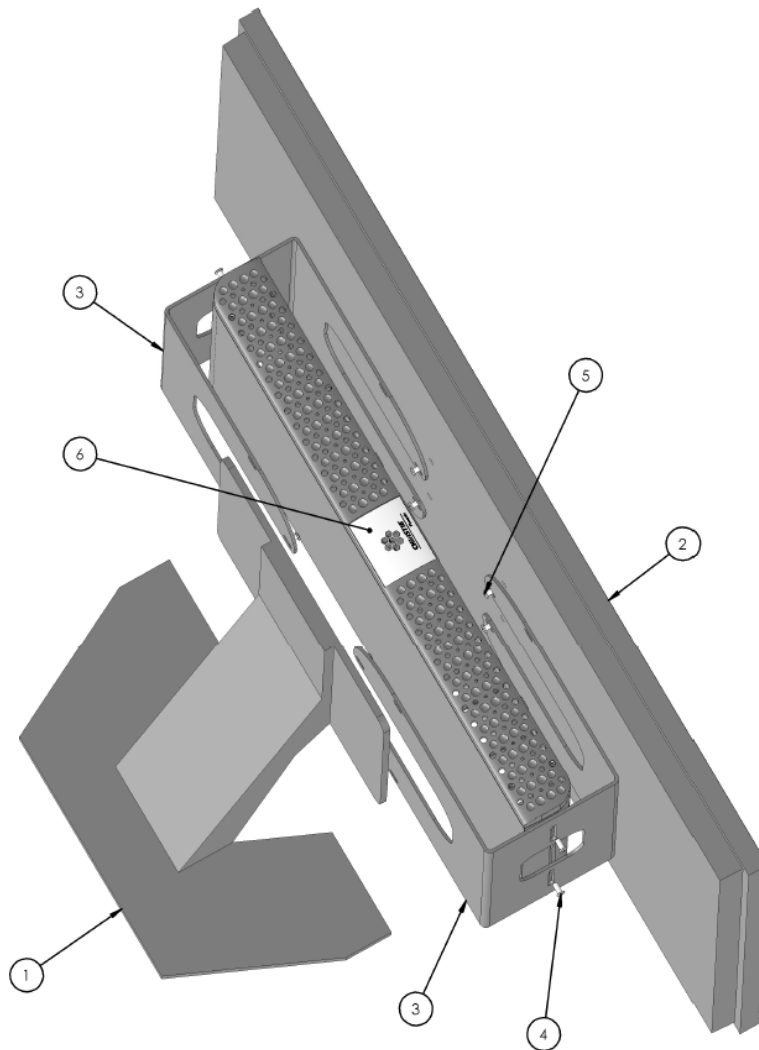

Figure 8 – VESA 2 Mounting Brackets

3. Attach the node to the bracket using the 4 small screws (8-32 x 3/8) provided with the bracket.

Networking

All Phoenix systems that need to interact with each other should be connected to the same LAN. Additionally, all Remote Desktop, VNC, and RTSP Stream sources must be connected to the same LAN as the Phoenix nodes.

Your network must be configured to support Internet Group Management Protocol version 2 (IGMPv2).

When you configure the system, you will need to know the IP addresses for each device. The worksheet in Appendix C (page 185) may be helpful for recording this information.

How to Connect the Nodes to a Network

The Phoenix system connectors support 1000BASE-T Ethernet.

Addresses for your LAN need to be assigned to each node or Dynamic Host Configuration Protocol (DHCP) must be enabled so the equipment is recognized by your LAN. Refer to [How to Edit a Node](#), page 87.

Tools and equipment required: Ethernet cabling, Ethernet switch, cable ties, and standard tool kit.

1. Mount the units (refer to [Mounting the Nodes](#), page 29).
2. Verify the unit is powered off.
3. Connect an Ethernet cable to the **Network 1** connector on the back of the unit.
4. Connect the other end to the Ethernet switch.
5. Repeat the above steps for each unit.



To ensure proper ventilation for the node, carefully route and dress the wiring to make sure the wiring does not obstruct air flow.

6. Power on the nodes.
7. Assign IP addresses to each unit to communicate with your network or enable DHCP (refer to [How to Edit a Node](#), page 87).



To avoid changes to the IP addresses, use static IP addresses.

Connect Sources to the Phoenix System

All sources for the Phoenix system must be connected either through the Phoenix system connectors or a LAN.



To ensure proper ventilation for the node, carefully route and dress the wiring to make sure the wiring does not obstruct air flow.

How to Connect Encoding Sources to the Network

Tools and equipment required: Sources, Ethernet cabling (Cat6a recommended), Ethernet switch, cable ties, and standard tool kit.

Connect all devices (e.g., PCs for remote desktop sources, PCs for VNC sources, RTSP Stream sources, etc.) that do not need to be encoded by the Phoenix system to the LAN.

How to Connect DVI Output Capable Devices

Tools and equipment required: Sources, DVI cabling, standard tool kit.

Connect all DVI Output Capable sources (e.g., Phoenix DVI Input devices) that need to be encoded by the Phoenix system to the Input A or Input B connectors on a Phoenix node.



When two DVI Output Capable inputs with different resolutions are connected to the same node (using Input A and Input B), the video loop-through function sets the output resolution for both sources to the resolution of the source connected to Input A. The source connected to Input B may appear distorted. The EDID configuration for Input B may be reconfigured to minimize this problem (refer to [Manage EDID Configurations](#), page 135).

How to Connect Cabling for Interaction Mode for a HID-Capable Device

Tools and equipment required: USB-A to Mini B cable (from the install kit), HID-capable device configured as Phoenix DVI Input source, and a Phoenix node encoding the source.

To interact with a HID-capable device that is configured as a Phoenix DVI Input source, you must connect the device to a node encoding the source as follows:

1. Connect the type-A connector of the USB-A to Mini B cable to a USB port on the source.
2. Connect the type-B (mini) connector to the correct KVM connector on the Phoenix node. If the source is connected to the Input A connector, connect the cable to the KVM A connector. If the source is connected to the Input B connector, connect the cable to the KVM B connector.
3. To enable the direct connection of the USB keyboard and mouse to a Phoenix node, contact Christie support to assist with the process.

The following illustrates the connections.

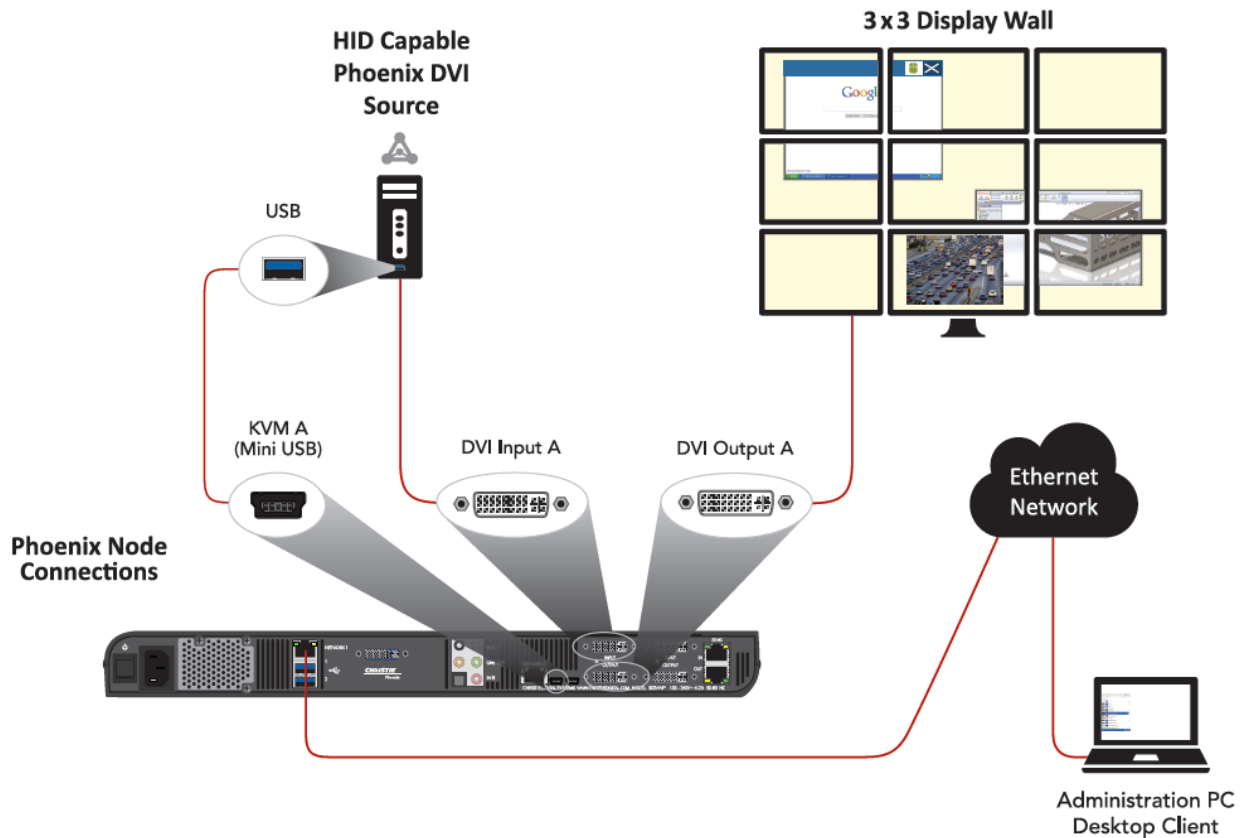

Figure 9 - Connections for Interaction

How to Connect Displays for the Walls

Connect all displays for the walls to the Output A and Output B connectors on the Phoenix nodes.

i You can configure up to 128 outputs for a wall.

How to Synchronize the Display Wall

There are two options for synchronizing the display wall:

- BackChannel
- Network

Synchronizing using the BackChannel Option

Tools and equipment required: RJ45 connectors and cables (CAT 5e cables are recommended)

i This option is not available for Phoenix EP nodes.

To synchronize the output for a display wall using the BackChannel option, connect the nodes that are displaying output on the wall using the Sync In and Sync Out connectors and a daisy chain loop wiring scheme as shown in [Figure 10](#).

To connect the nodes:

1. On the first node, connect an RJ45 connector to the Sync Out connector, and then connect the other end to the Sync In connector on the next node.
2. Repeat the above step for each node that needs to be synchronized.
3. On the first node, connect an RJ45 connector to the Sync In connector, and then connect the other end to Sync Out connector on the last node.

1. Controller



2. Last Sync



3. Master Sync



4. Node



5. Node



Out 5 to In 1

Out 1 to In 2

Out 2 to In 3

Out 3 to In 4

Out 4 to In 5

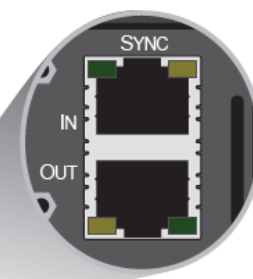

Master Sync:
Light OFF

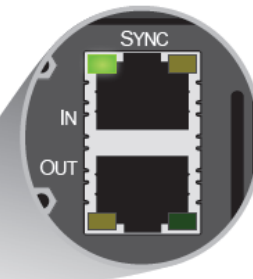

All other nodes:
Light ON

Figure 10 - Synchronizing Nodes

4. Enable synchronization on the wall profile (refer to [How to Add a Wall](#), page 92).

Synchronizing using the Network Option

Tools and equipment required: None

To synchronize the output for a display wall using the Network option, select the Network option for the Enable Frame Synchronization on step 2 of the Edit Wall page.

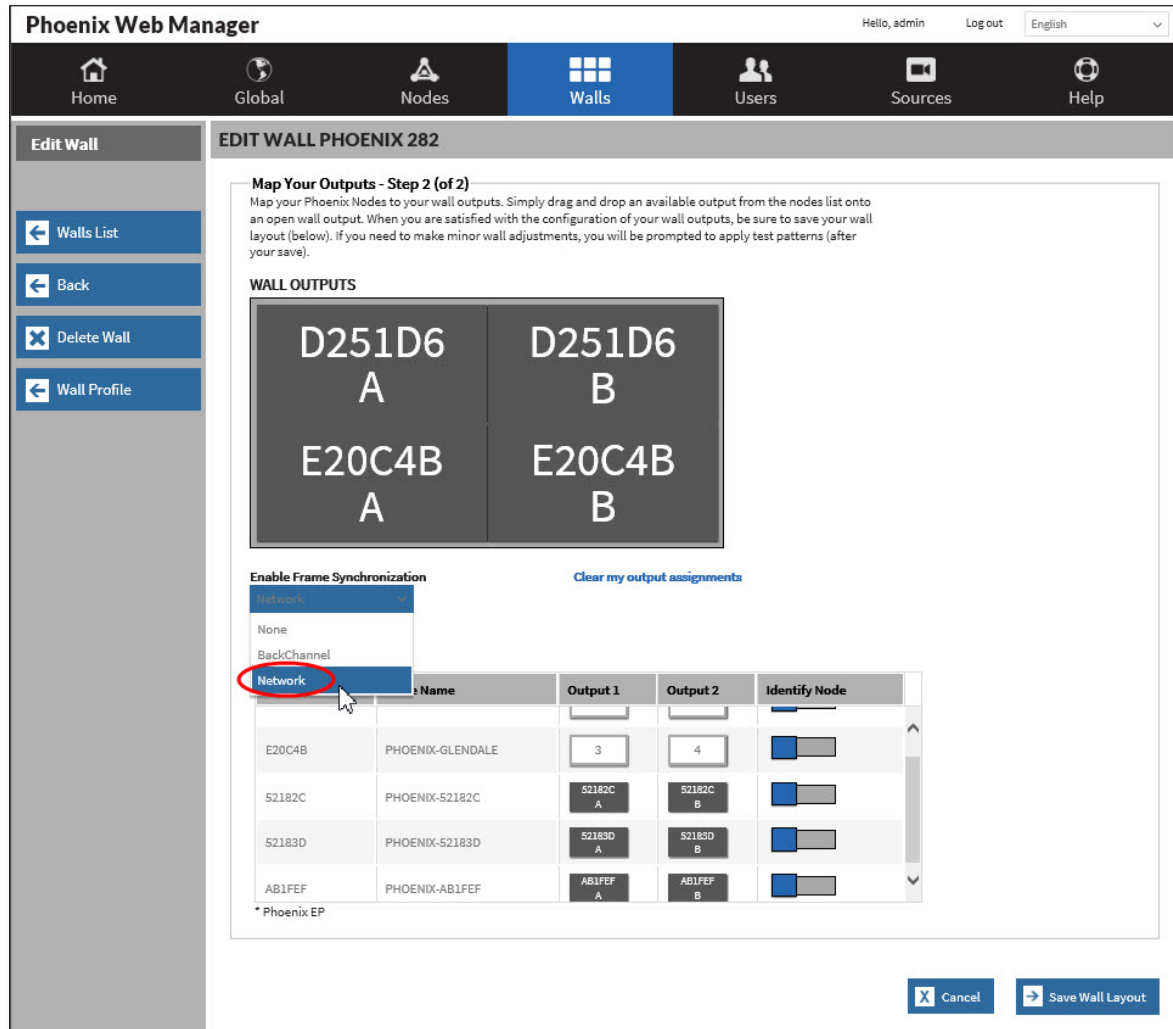

How to Connect Audio for a Source on a Wall

1. Connect the audio out cable for the DVI source connected to the Input A connector to the blue In A connector on the Phoenix system.
2. Connect the audio out cable for the DVI source connected to the Input B connector to the pink In B connector on the Phoenix system.
3. Connect the audio out from the speaker to the green Line Out connector.

Refer to [Configure Audio for a Wall](#) (page 174) for additional details.

How to Connect Power to the Nodes

Tools and equipment required: power cord (provided) and power source

1. Connect the power cord to the power connector on the back of the Phoenix unit.

2. Connect the other end to a power source.

Connect a Management Computer to the Phoenix System

One or more management computers are used to monitor and configure the Phoenix system.



The management PC cannot be connected to both a wireless network connection and to a wired network connection.

There are two ways to connect a management PC:

- The PC has to be on the same subnet as the Phoenix controller. If connected on the same subnet, the Desktop Client will auto-discover the controller.
- If the management PC is not on the same subnet, the controller will not be auto-discovered and you will have to enter the IP address of the controller in the Desktop Client.

Computer Requirements

A computer used to access the Phoenix system requires the following:

- One Ethernet port
- Windows 7 or later operating system
- 1 GB (minimum) RAM
- 100 MB free hard disk space
- .NET 4.5 Framework or higher
- Microsoft Visual C++ 2010 or higher (10.0.40219)

Configure a Controller

The Controller Manager Wizard is used to assign a node as the controller, un-assign a node from the controller role, or update a controller.

i Use the identify node feature to help you identify nodes.

A controller manages one or more nodes on a network. One controller can manage up to 64 nodes.

i Only one node needs to be assigned as the controller.

To assign a controller for one or more nodes, you need to connect all the nodes and a management PC to the same LAN.

i Make sure your wireless adapter on your PC is disabled to avoid detecting any other devices.

How to Start the Controller Manager Wizard

To install and start the Controller Manager Wizard on your PC:

1. Insert the flash drive that was shipped with the Phoenix system into a USB port on your PC.
2. Double-click **ControllerManager.exe** and allow the software to run on your PC.
When the wizard starts, the following page is displayed:



3. Click an icon to:
 - Assign Controller (refer to [How to Assign a Node as the Controller](#), page 40).

- Un-Assign Controller (refer to *How to Deactivate a Controller*, page 42).
- Update Controller (refer to *How to Update a Controller*, page 43).

How to Assign a Node as the Controller

To assign a node as a controller:

1. Start the Controller Manager Wizard (refer to *How to Start the Controller Manager Wizard*, page 39).
2. Click **Assign Controller**.
3. Select a node from the list to be used as the controller, and then click **Next**.

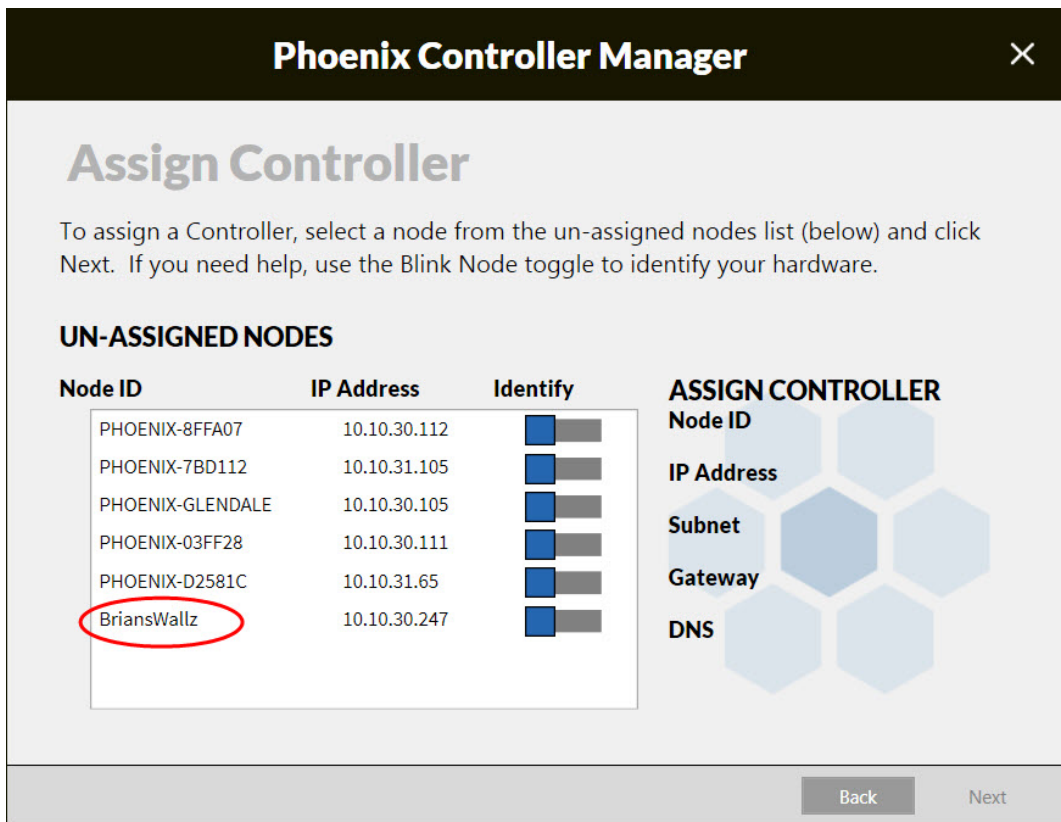

Use the Identify Node to help you locate the node.

4. After the wizard assigns the controller, optionally type a name to identify the controller, assign a new IP address, a Subnet, a Gateway, and/or a DNS to the controller; and then click **Finish**.

Phoenix Controller Manager
✕

Update Controller

You have assigned a Controller.

Below are the current settings for this Phoenix Node. You may accept the current settings or make additional updates. When you are finished, click Finish.

Controller

Node ID	Node Name	IP Address	Subnet
7BCAC2	BriansWallz	10.10.30.247	255.255.254.0
		Gateway	DNS
		10.10.30.1	10.10.40.19

Node ID	Node Name	New IP Address
7BCAC2	<input type="text" value="BriansWallz"/>	<input type="text" value="10.10.30.247"/>

Subnet	Gateway	DNS
<input type="text" value="255.255.254.0"/>	<input type="text" value="10.10.30.1"/>	<input type="text" value="10.10.40.19"/>

Back
Finish

5. Click **Go to Web Manager** to configure your system.

Phoenix Controller Manager
✕

Finished!

You have assigned a Controller.

Assigned Controller

Node ID	Node Name	IP Address
7BCAC2	BriansWallz	10.10.30.247

You may close this window, or click Go to Web Manager.

Back
Go to Web Manager

How to Deactivate a Controller

When you deactivate a controller, it has a 'Un-assigned' node status. You can edit the node profile to assign it a new role (refer to [How to Edit a Node](#), page 87).

To deactivate a controller:

1. Start the Controller Manager Wizard (refer to [How to Start the Controller Manager Wizard](#), page 39).
2. Click **Un-Assign Controller**.

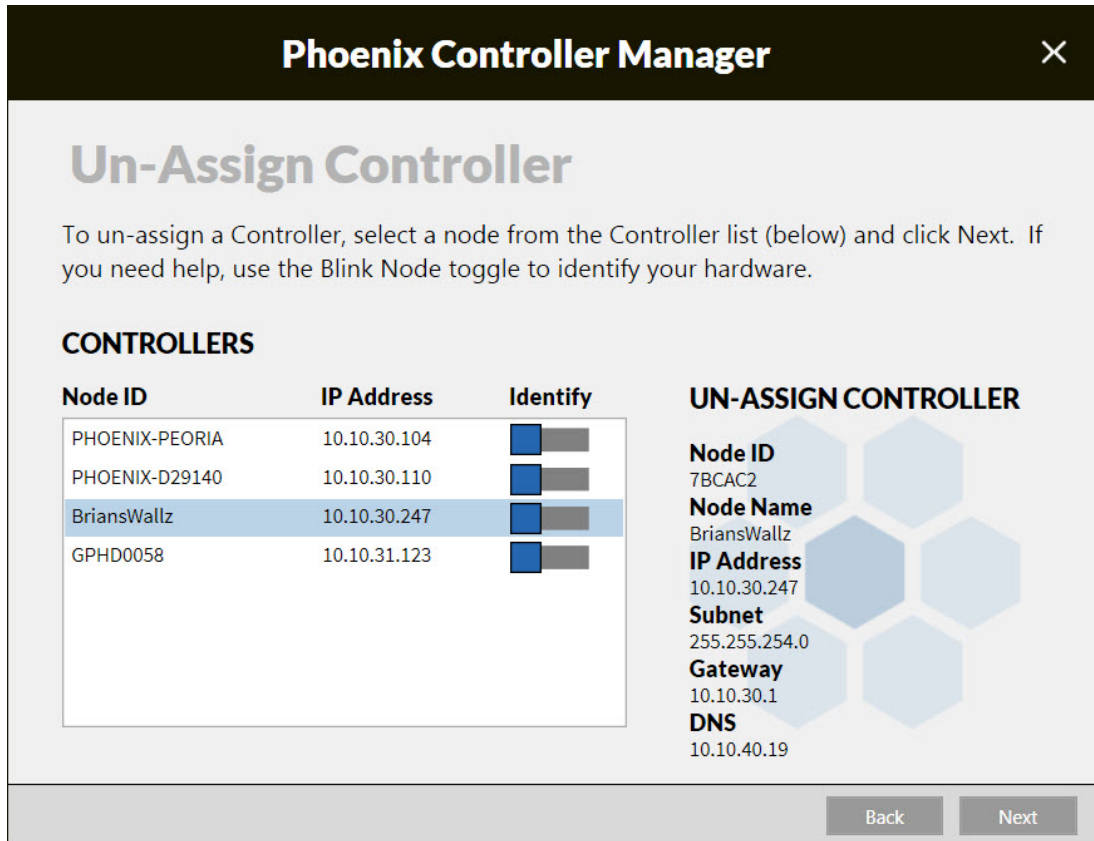

3. Select the controller you want to deactivate, and then click **Next**.

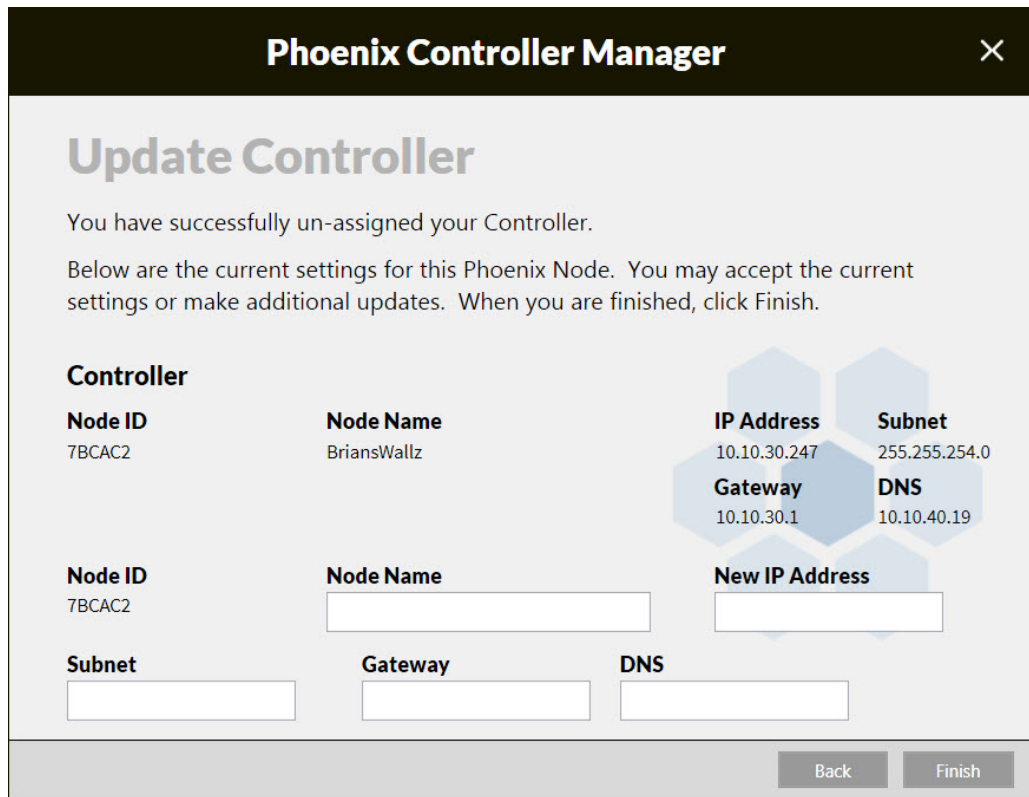

4. Optionally, after the wizard un-assigns the controller, change the name, the Subnet, the Gateway, and/or the DNS to the controller and then click **Finish**.
5. To delete all configuration data, use the Wipe System option. Refer to *Wipe System (Restore to factory defaults)*, page 126. It is advisable to create a backup of your system before using the Wipe System option.
6. To assign a controller, click **Assign Controller**; or close the wizard.

How to Update a Controller

You can assign a new name or a new IP address for an existing controller.

To update a controller:

1. Start the Controller Manager Wizard (refer to *How to Start the Controller Manager Wizard*, page 39).
2. Click **Update Controller**.

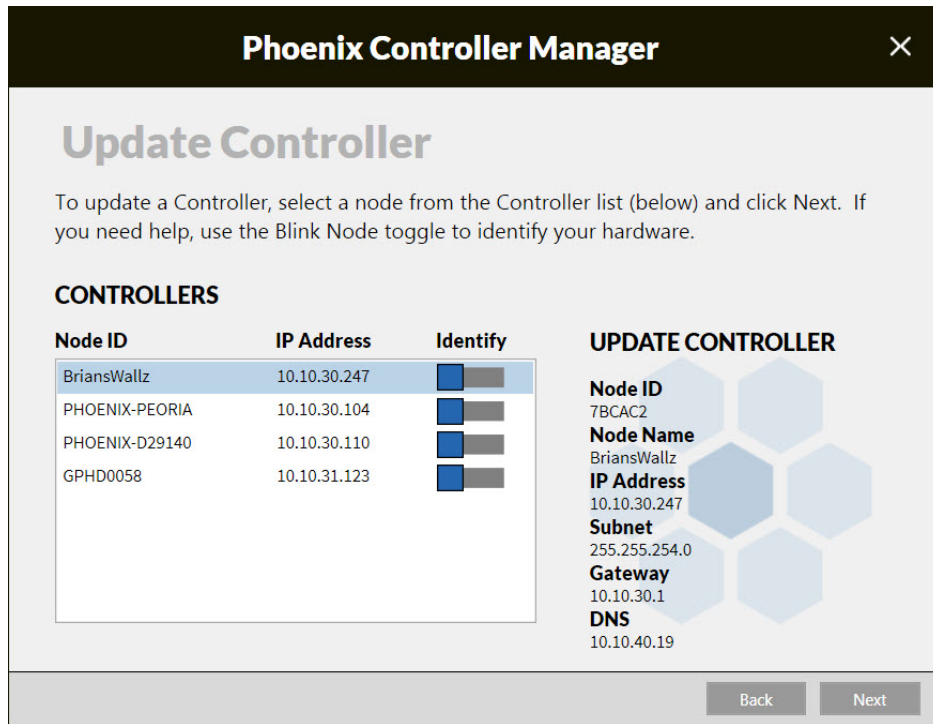

3. Select the controller you want to update, and then click **Next**.

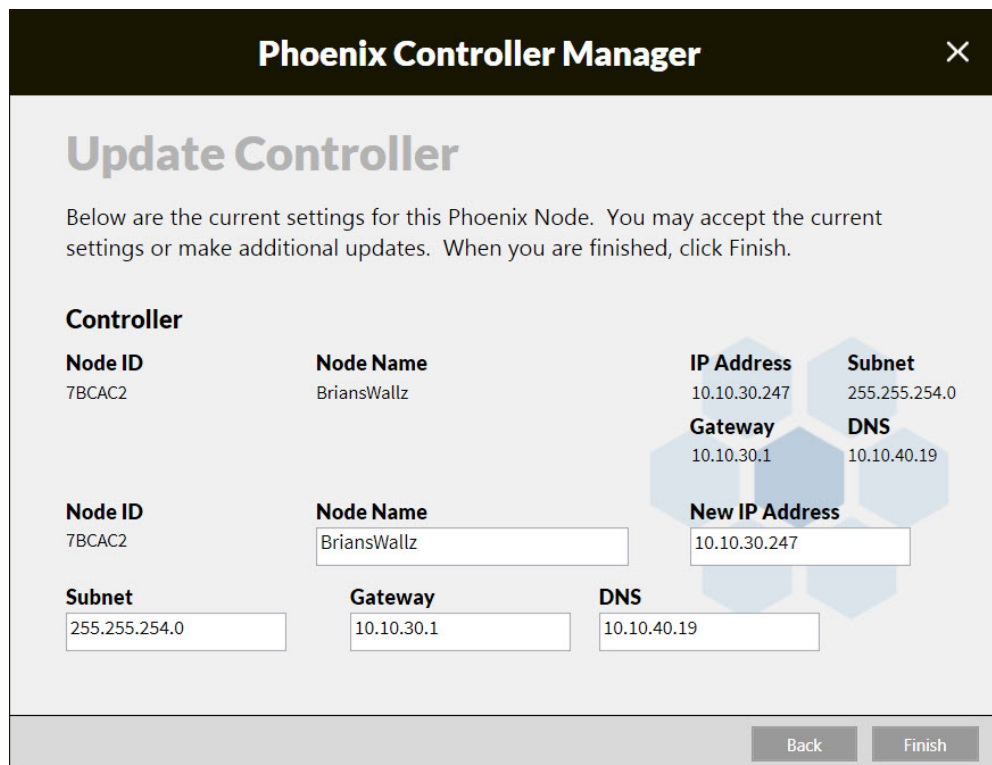

4. Optionally, type a name to identify the controller and/or type a new IP address, a Subnet, a Gateway, and/or a DNS for the controller, and then click **Finish**.

Web Manager

The Web Manager is used by administrators to configure the system. It can be accessed using a Web browser.

Supported Browsers

The following Web browsers are supported:



Only the latest of each version is supported.

- Internet Explorer, version 9.x, 10.x, and 11.x.
- Firefox
- Chrome
- Safari

Access the Web Manager

For security purposes, it is recommended to install the website security certificate on your desktop PC before accessing the Phoenix Web Manager. Internet Explorer must be used in Administrator Mode to install the certificate. The certificate only needs to be installed once, the first time you attempt to access the Web Manager when using the Stringent security option.

Installing the Security Certificate

1. Run IE as an administrator.
 - a. Right-click the IE icon pinned to the taskbar.
 - b. On the right-click menu, right click **Internet Explorer**.
 - c. Click **Run as administrator**.
 - d. Click **Yes** when prompted to allow program to make changes
2. Browse to the IP address of the Phoenix controller by entering its IP address in an Internet Explorer (IE) browser's address field. The following message is displayed.

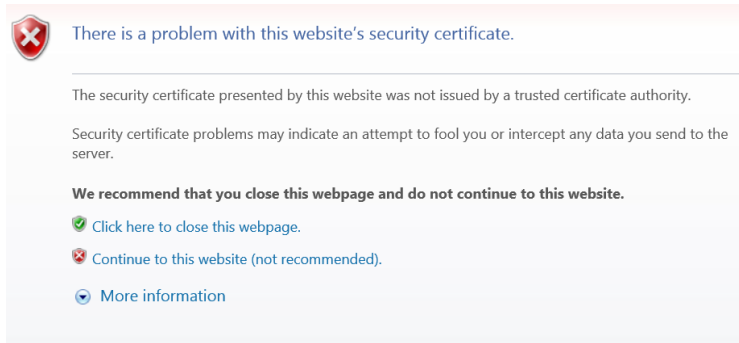

- To install the certificate, which is recommended for security purposes, click **Continue to this website (not recommended)**.

The Address bar turns red and a Certificate Error message appears in the Security Status bar (next to the Address bar).

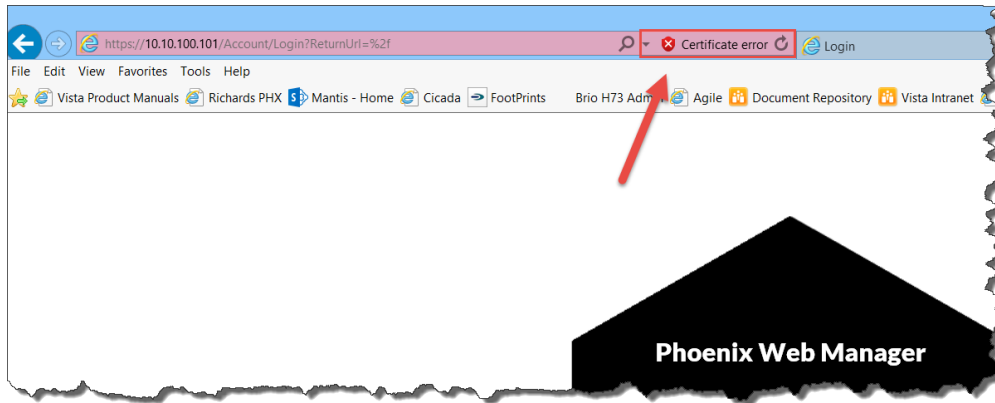

- Click the **Certificate error** message.

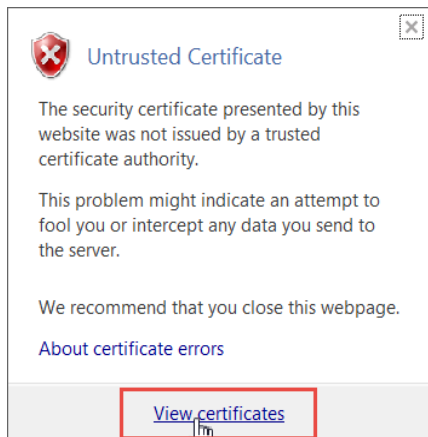

- Click **View certificates**. The Certificate Information is displayed.

- Click **Install Certificate**.

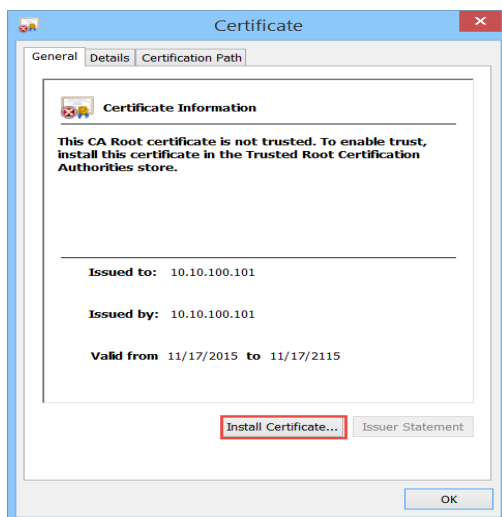

- Select Current User and click **Next**.

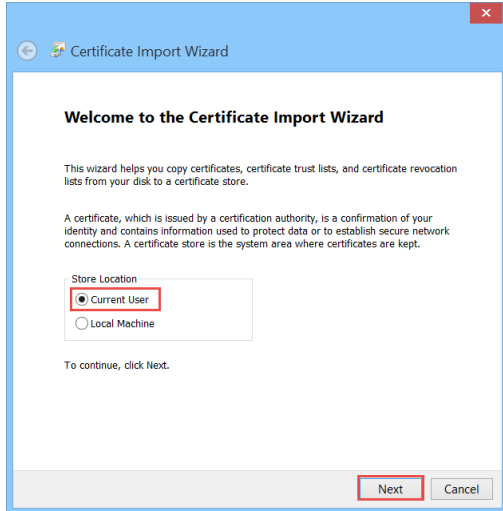

8. Select Place all certificates in the following store, browse to Trusted Root Certifications Authorities, and then click **Next**.

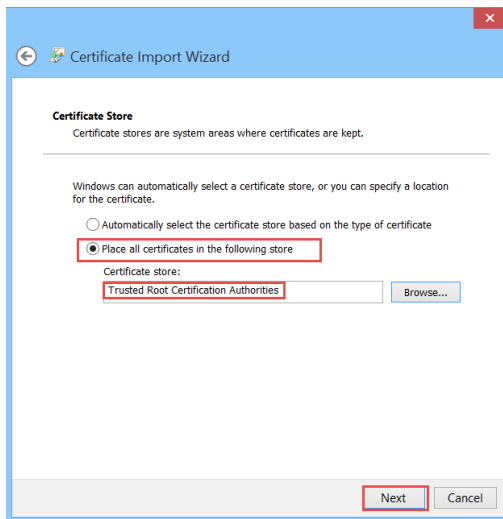

9. Click Finish.

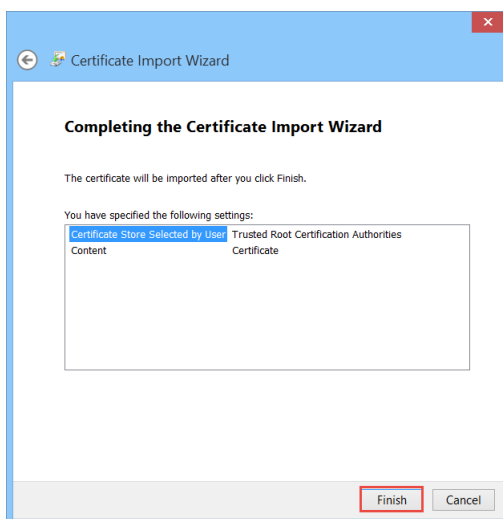

10. Click **Yes** to install the certificate. A success dialog is displayed when completed.

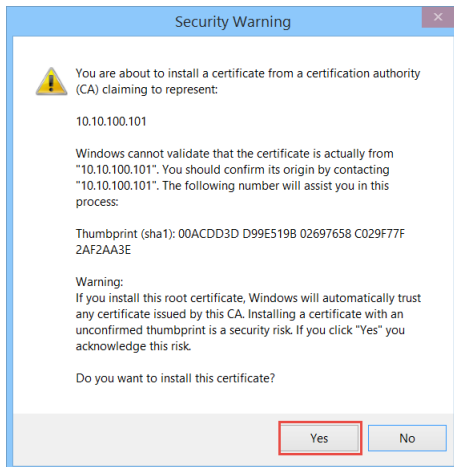

11. Close IE and restart it. If your certificate is not available, restart your computer.

Logging in to the Web Manager

From the log in page of the Web Manager, you can do the following:

- Sign in to access the Web Manager features. Refer to [How to Sign in to the Web Manager](#), page 48.
- Access security questions if you forgot your password.
- Change your security questions.
- Download the Desktop Client Software. Refer to [How to Install the Desktop Client Software](#), page 144.
- Download the Phoenix Import Utility. Refer to [How to Install the Phoenix Import Utility](#), page 61.

Only users that are assigned an administrator role can access the Web Manager (refer to [Manage Users](#), page 105).

To interact with the Phoenix system, you must connect a computer to the same LAN as the controller and browse to the Phoenix system Web Manager.



Normal Web page conventions are used throughout the Web interface. This document assumes you are familiar with these concepts.

A Web browser is needed to access the Web interface. To access the Phoenix system, enter the valid IP address of the node assigned as the controller in your Web browser address field. For example:

- <http://<Phoenix IP Address>> (e.g., <http://169.168.1.11>)

You can use the Phoenix System Controller Wizard to find the IP address for each node. Refer to [How to Connect the Nodes to a Network](#) (page 33) for details.

How to Sign in to the Web Manager

To sign in, perform the following:

1. To display the sign in page, browse to the IP address of the controller by entering its IP address in your browser's address field.

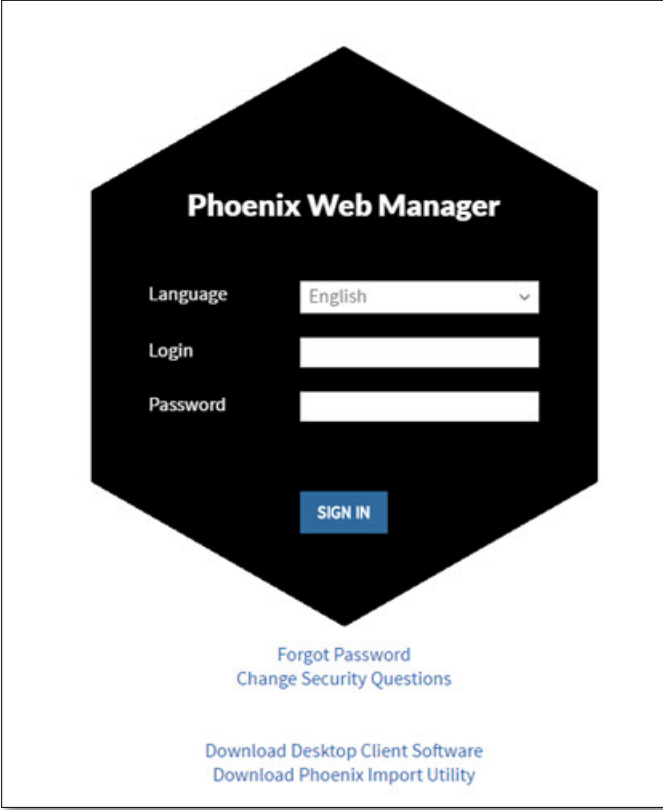

Figure 11 – Sign In Page

2. In the Login field, type **service**.
3. In the Password field, type **service** (case sensitive).



Passwords are masked. To display the password after you type it, click and hold the mouse on the Show Password icon (👁) in the Password field (this icon is not supported in all browsers).

You are forced to change the default password for security purposes. Refer to [How to Force Users to Logout](#)



If needed, administrators can force users to logout.

1. On the Users page, select one or more user names.
2. Click **Force Logoff**.

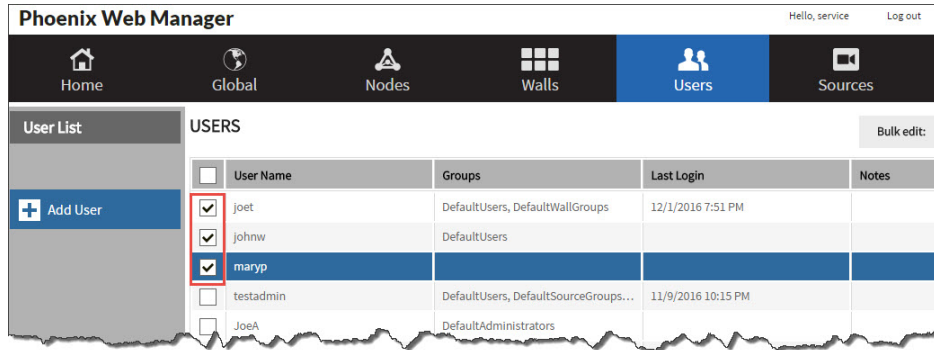

3. The selected users will be logged out and notified with a pop-up message:

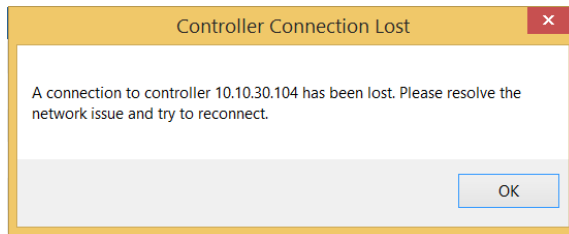

How to Change the Default Password, page [111](#). If you attempt to login in using an invalid password three times, your account will be locked. You must contact an administrator for assistance.

4. Click **SIGN IN**.
5. Select your security questions and answers, enter the new password for the default account, and then click **Save**.

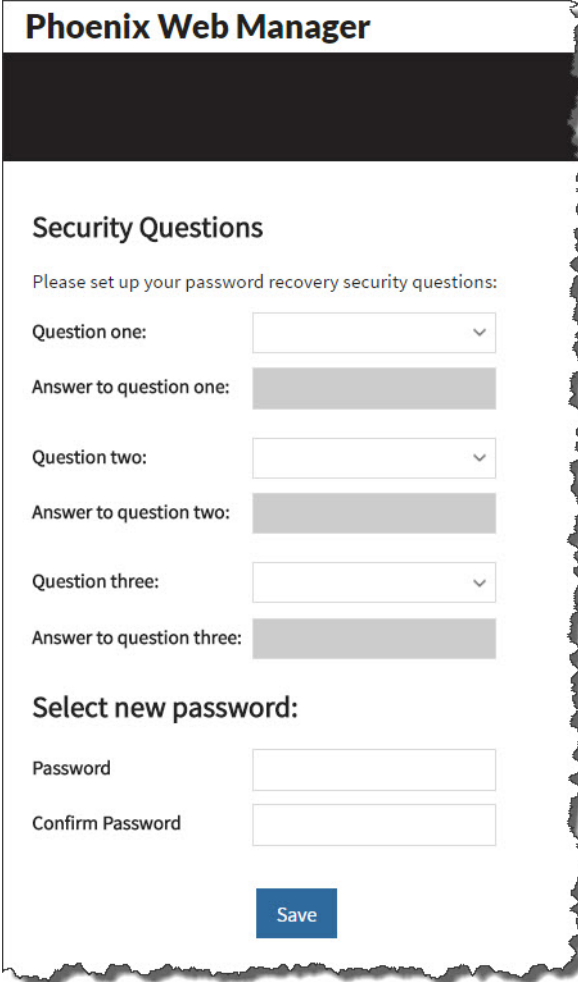

The screenshot shows the Phoenix Web Manager interface. At the top, there is a header with the text "Phoenix Web Manager" on a black background. Below the header, the page is titled "Security Questions". A sub-header reads "Please set up your password recovery security questions:". There are three sets of input fields. Each set consists of a dropdown menu for the question and a text input field for the answer. The questions are labeled "Question one:", "Question two:", and "Question three:". Below the questions, there is a section titled "Select new password:" with two text input fields labeled "Password" and "Confirm Password". At the bottom of the form is a blue "Save" button.

6. Log in using the new password.
When you are logged in, the Phoenix Web Manager Home page is displayed.



The Web Manager software times out after 10 minutes of inactivity.

Web Manager Main Menu

The main menu options are displayed on the top of the page (see [Figure 12](#)). The user name, current language, and the status of any alerts are displayed on the Home page.

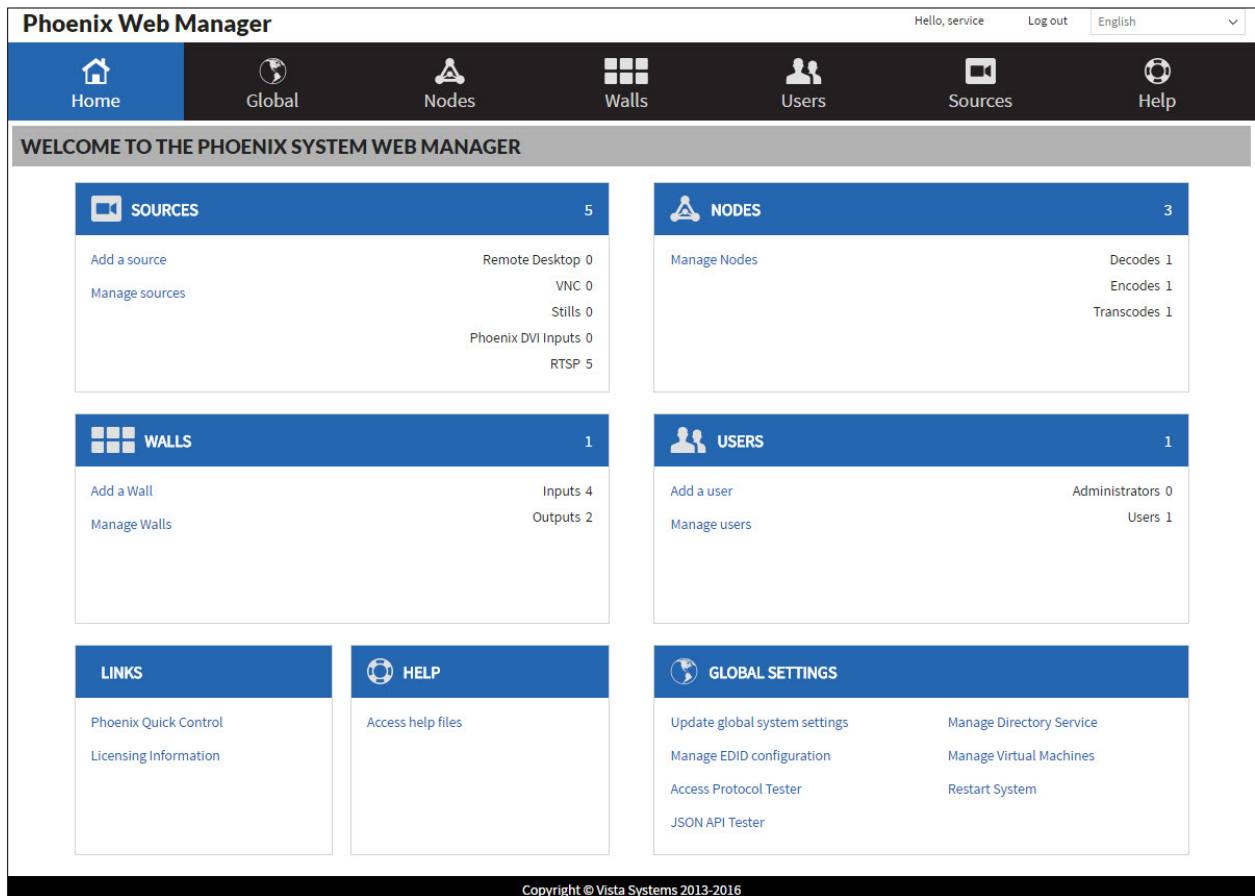

Figure 12 – Home Page

This page enables you to:

- View the status of any active alerts.
- Add and manage sources and view the current number and types of sources.
- Manage nodes and view the current number and types of nodes.
- Add and manage walls and view the current number and types of walls.
- Add and manage users and view the current number of users and types of users.
- Manage global settings for the system, manage EDID configurations, and access the protocol tester.
- Access help files.
- Access the Phoenix Quick Control.
- Access software licensing information.

Status

The status for nodes and sources is determined by the highest level of active alerts. The system alerts are displayed across the top of the Phoenix Web Manager web page.

Valid values are:

Status	Description	Icon
Warning	One or more warning alerts are active.	⚠
Critical	One or more critical alerts are active.	✖

The related alert icon is displayed next to the Nodes or Sources on the home page, depending on the origin of the alert (refer to the following example). To view the details, click on the icon on the Home page, and then hover over the icon in the Notes section of the node or source.

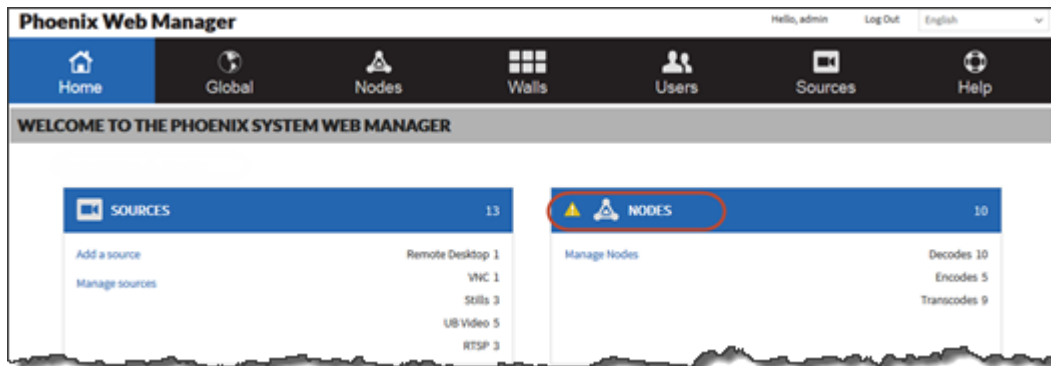

Figure 13 - Status



If a node is disconnected from a controller, a critical alert is activated for this condition and the alert must be acknowledged on the Home page.



Manage Sources

To manage sources, click **Manage Sources** on the Home page or click **Sources** in the main navigation area.

From this page you can display a list of sources, add a source, edit a source, delete a source, and define titling overrides for a source.

How to View a Source List

To view a list of sources, click **Manage Sources** on the Home page or click **Sources** in the main navigation area. The list of sources is displayed.

Source List		SOURCES				
		Source Name - Title	Type	Resolution	Aspect Ratio	Notes
All Sources	(15)	Source 5 - Sony BD5		1920 x 1080	16 x 9	Phoenix103-A
Remote Desktop	(0)	Source 6 - Sony BD6		1920 x 1080	16 x 9	Phoenix103-B
RTSP Stream	(2)	Source 7 - Sony BD7		1920 x 1080	16 x 9	Phoenix104-A
Still Images	(1)	Source 8 - Sony BD8		1920 x 1080	16 x 9	Phoenix104-B
Phoenix DVI Input	(10)	Source 9 - Sony BD9		1920 x 1080	16 x 9	Phoenix105-A
VNC	(2)	Source 10 - Sony BD10		1920 x 1080	16 x 9	Phoenix105-B
Add Source		Source 11 - Sony BD11		1920 x 1080	16 x 9	Phoenix106-A
		Source 13 - Digix BD13		1920 x 1080	16 x 9	
		Source 14 - Sony BD14		720 x 480	3 x 2	Phoenix107-B
		Workstation 1 - Workstation 1		1920 x 1080	16 x 9	
		Ranorex_still - Ranorex_still		1024 x 768	4 x 3	
		Source 15 - Workstation 1 (DVI)		Pending	Pending	
		Mike's Laptop - Mike's Laptop		3840 x 1080	32 x 9	
		Axis 1 - Cam 1		1920 x 1080	16 x 9	
		Axis 2 - Cam 2		1920 x 1080	16 x 9	

Figure 14 – Source List

The following are displayed for each source: source name and title, an icon representing the source type, resolution, aspect ratio, and notes. This page also indicates if there are any active alerts for any sources.

How to Add a Source

To add a source, click **Add Source** from the Source List page. The Add Source page (1 of 2) is displayed.

Before adding a source, ensure the resolution for the source is not variable. The resolution should be set to a fixed resolution. Check the manufacturer’s documentation.

Source Types

Depending on the type of source you want to add, refer to the following:

The fields on the Add Source page vary based on the source type selection.

Source Type	Reference
Phoenix DVI Input	How to Add a Phoenix DVI Input Source , page 55
RTSP Stream	How to Add an RTSP Stream Source , page 58
VNC	How to Add a VNC Source , page 65
Remote Desktop	How to Add a Remote Desktop Source , page 70
Still	How to Add a Still Source , page 73
Application	How to Add an Application Source , page 75

How to Add a Phoenix DVI Input Source

What you need: Any device with a DVI or H-DVI connector (e.g.; PC or DVD player) connected to a Phoenix node.



For any device connected to the Phoenix node through the Input A and Input B connectors, the incoming video from the DVI (that will be encoded) can have a maximum resolution of 1080p. Verify the setting on your device.

Interlaced formats are not supported.

What is supported with this source type: audio and video.

A Phoenix DVI Input source requires a device to be connected to a Phoenix system input connector (Input A or Input B), and the node must be set to encode the source.

The Phoenix system performs the encoding for this source.

The screenshot shows the 'Phoenix Web Manager' interface. The top navigation bar includes 'Home', 'Global', 'Nodes', 'Walls', 'Users', 'Sources' (highlighted), and 'Help'. The user is logged in as 'admin'. The main content area is titled 'ADD SOURCE' and shows the configuration for a 'Phoenix DVI Input' source. The 'Source Type' is set to 'Phoenix DVI Input'. The 'Source Name' field is required. The 'Source Title (for walls)' is optional. The 'Default Treatment' is set to 'No Treatment'. The 'Group' is set to '{Root}'. The 'Thumbnail Refresh Interval' is set to 'Never'. There is an option to 'Override Default Bitrate' set to '4,000 Kbps'. The 'Phoenix DVI Input Info' section includes 'Phoenix Node' (PHOENIX-AB1FEF) and 'Input' (Input A). Under 'EDID Configuration', the 'Leave existing EDID configuration' radio button is selected. There are checkboxes for 'Override MTU', 'Allow Interaction', 'Audio Allowed', 'Manned (operator attended)', and 'Optimized for Text'. A 'Directory Groups' dropdown is set to '-- Select --'. A 'Titling Overrides' section at the bottom has a checkbox for 'Yes, I want to override the default titling on this source.' which is currently unchecked. A 'Save' button is located at the bottom right.

Figure 15 – Add Phoenix DVI Input Source

1. In the **Source Type** field, click **Phoenix DVI Input** to add a stream encoded by a Phoenix system.
2. Configure the details using the information in the following table.
3. If desired, configure the titling overrides for all walls. Refer to [How to Create Titling Overrides](#) (page 77).

4. Click **Save**.

Table 6 — Phoenix DVI Input Fields



Field	Description	
Source Type	Phoenix DVI Input.	
Source Name	User-defined name for the source, maximum of 20 characters. This is a required field and will help you identify the source in the list of sources.	
Source Title (for walls)	User-defined title for the source, maximum of 20 characters. This is an optional field and will help you identify the source in the list of sources and on walls.	
Default Treatment	Default treatments are populated by treatments that have been created by users.  When setting up a new system there will be no default treatments available. After the treatments are created, a source can be edited to apply a treatment.	
Group	Creates a folder in the source list in the Desktop Client and adds the source to the folder; or if the folder exists, adds the source to an existing folder. Groups are used to organize sources into folders in the Desktop Client.	
Thumbnail Refresh Interval	Refresh interval for updating thumbnails on the Sources list and on the wall simulator in the Desktop Client. Valid values are never, less frequently (every 75 seconds), normal (every 60 seconds), or more frequently (every 45 seconds).  These times can vary based on the number of sources you have configured.	
Override Default Bitrate	Check box to enable an override of the default bitrate. When selected, specify the bitrate for the source. The valid range is 0-20 Mbps. The default value is 4000 Kbps. The default bitrate can be viewed on the System Settings page (refer to How to Set Encoding Defaults , page 119page 117).	
Phoenix DVI Input Info	Phoenix Node	The node ID of the node the source is connected to. The node ID is selected from the drop down list of available nodes.
	Input	The input connector that the source is connected to, Input A or Input B.
	EDID Configuration	Specifies the Extended Display Identification Data (EDID) configuration of the source by specifying a file name, a wall, or existing EDID configuration. The existing EDID configuration is automatically detected. You can change the configuration using the EDID Manager (refer to How to Manage EDID Configurations , page 135).
Override MTU	Check box to override the global setting for MTU. When selected, select a new value from the drop down list to set the value for this source only.	
Allow Interaction	Check box to enable a user to interact with the source. For additional information, refer to Interaction Mode , page 176. If you are interacting with a HID-capable device configured as a Phoenix DVI Input source on a display wall, additional cabling is required (refer to How to Connect Cabling for Interaction Mode , page 34). When interaction mode is enabled for a source, a USB icon is displayed in the Capabilities Allowed field on the Source Profile page.	
Audio Allowed	Check box to enable audio for the source. When enabled, a speaker icon is displayed in the Capabilities Allowed field on the Source Profile page. Also, refer to Configure Audio for a Wall , page 174.	
Manned (operator attended)	Check box to indicate the source is monitored by a person. When enabled, a person () icon is displayed in the Manned field on the Source Profile page.	

Table 6 — Phoenix DVI Input Fields

Field	Description
Optimized for Text	Used to enhance text on displays. <div style="display: flex; align-items: center;"> <div style="border: 1px solid gray; border-radius: 50%; width: 30px; height: 30px; display: flex; align-items: center; justify-content: center; margin-right: 10px;">i</div> <div> <p>This setting should not be used without guidance from Christie support personnel. When set, it can lead to high streaming data rates that stress the network.</p> <p>To enable this feature, the Controller must be manually restarted.</p> </div> </div>
Directory Groups	Used to select the Directory Groups for this source. A source can be added to 10 groups. To remove a source from a group, select x .

How to Share a DVI Source with a Controller for a Different Phoenix System

A DVI source can be exported and imported onto another controller as a RTSP source.

1. Select one or more sources you want to share with another controller.
2. Click **Download RTSP** to download the selected source(s) as a .CSV file. The .CSV file can only be imported by a different controller; it cannot be used with the current controller.

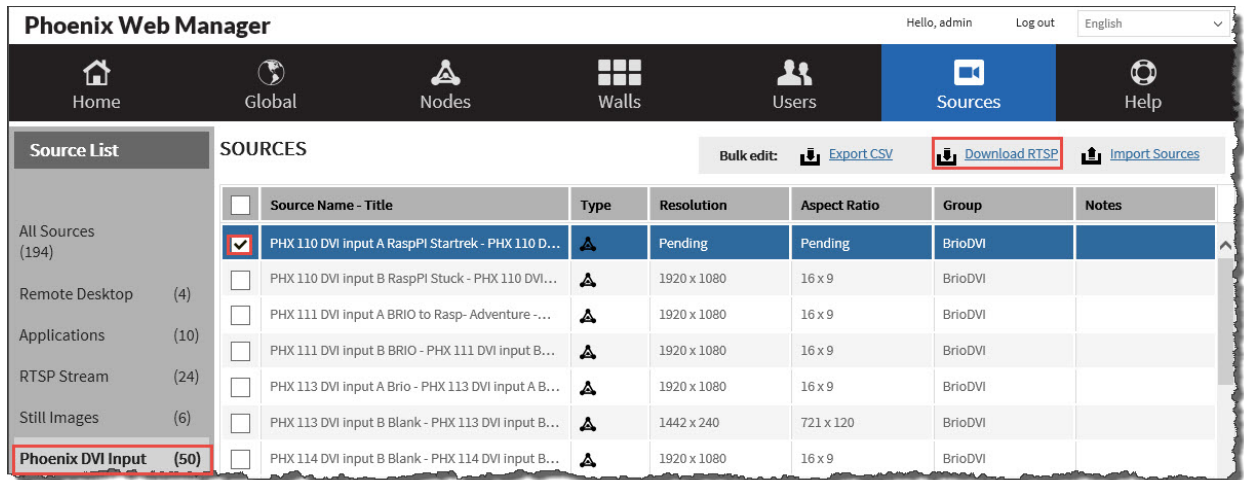

3. Click **OK** to confirm the download.
4. Click **Save** to save the file to the desired location.
5. From the controller that you want to share the source with, click **RTSP Streams**.
6. Click **Import Sources**.

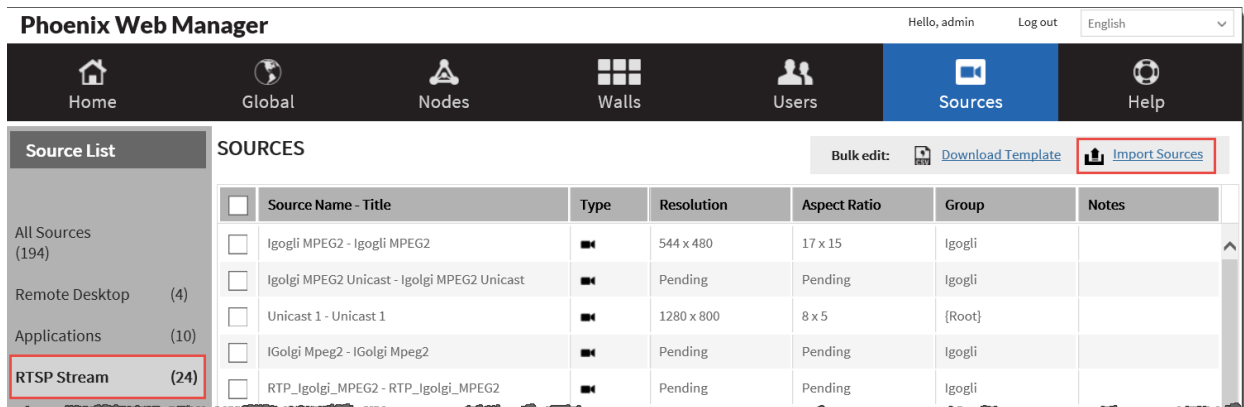

7. Browse to the .CSV file you created from the DVI source in the steps above.
8. Click **Open**.
9. Open the Phoenix Desktop Client using the controller for the new source.

10. From the Desktop Client, open the wall you want to add the new RTSP source.
11. Drag the RTSP source onto the wall.

How to Add an RTSP Stream Source

What you need: Encoding device connected to the network.

What is supported with this source type: audio and video.



All networking streaming devices must support Real Time Streaming Protocol (RTSP) with H.264 video.

Figure 16 – Add RTSP Stream Source

1. In the **Source Type** field, click **RTSP Stream** to add a Real Time Streaming Protocol stream source.
2. Configure the details using the information in the following table.
3. If desired, configure the titling overrides for all walls. Refer to [How to Create Titling Overrides](#) (page 77).
4. Click **Save**.

Table 7 – RTSP Fields



Field	Description
Source Type	RTSP Stream.
Protocol Type	The protocol type for the source, RTP (Real-time Transport Protocol), UDP (User Datagram Protocol), RTSP (Real Time Streaming Protocol), or QUADT (Phoenix Quad-T).
Source Name	User-defined name for the source, maximum of 20 characters. This is a required field and will help you identify the source in the list of sources.
Source Title (for walls)	User-defined title for the source, maximum of 20 characters. This is an optional field and will help you identify the source in the list of sources and on walls.
Default Treatment	<p>Default treatments are populated by treatments that have been created by users.</p> <p> When setting up a new system there will be no default treatments available. After the treatments are created, a source can be edited to apply a treatment.</p>
Group	Creates a folder in the source list in the Desktop Client and adds the source to the folder; or if the folder exists, adds the source to an existing folder. Groups are used to organize sources into folders in the Desktop Client.
Thumbnail Refresh Interval	<p>Refresh interval for updating thumbnails on the Sources list and on the wall simulator in the Desktop Client. Valid values are never, less frequently (every 75 seconds), normal (every 60 seconds), or more frequently (every 45 seconds).</p> <p> These times can vary based on the number of sources you have configured.</p>

Table 7 — RTSP Fields





Field	Description																
Network Info	<p>The network location of the RTSP Stream source.</p> <p> For all RTSP sources, make sure to assign all IP and subnet settings when configuring the device. You must use the same settings when adding the source to the Phoenix system using the Web Manager.</p> <p>The management PC cannot be connected to a wireless network connection and to a wired network connection. If it is connected to both, the RTSP sources will not display on the display wall.</p> <table border="1" data-bbox="477 512 1412 604"> <tr> <td data-bbox="477 512 714 604">Source Address (name or IP)</td> <td data-bbox="714 512 1412 604">The DNS name or IP address of the source. To use a DNS name, the DNS name must be set using the Edit Node page. Refer to How to Edit a Node, page 87.</td> </tr> </table> <table border="1" data-bbox="477 613 1412 705"> <tr> <td data-bbox="477 613 714 705">Port</td> <td data-bbox="714 613 1412 705">The port number associated with the IP address of the source. The default value is 554, except for QUADT; the default value for QUADT is 8554.</td> </tr> </table> <table border="1" data-bbox="477 714 1412 1310"> <tr> <td data-bbox="477 714 714 1310">Video File Name</td> <td data-bbox="714 714 1412 1310"> <p>User-defined name for the file. This is a required field. The file name is set by the manufacturer (for example: axis-media/media.amp?videocodec=h264&audio=1).</p> <p>For Phoenix Quad-T sources (Protocol Type is set to QUADT), use the following video file names for each source connected to a HDMI connector:</p> <table border="1" data-bbox="743 898 1273 1058"> <tr> <td>v1</td> <td>HDMI 1 connector</td> </tr> <tr> <td>v2</td> <td>HDMI 2 connector</td> </tr> <tr> <td>v3</td> <td>HDMI 3 connector</td> </tr> <tr> <td>v4</td> <td>HDMI 4 connector</td> </tr> </table> <p>Here is a useful link to a list of IP camera sites: http://www.soleratec.com/rtsp/</p> <p> If you do not have the file for your device, search the manufacturer’s Web site for the device and model. The information for each device should be available; if it is not, contact the manufacturer. Copy the file name to a text file for ease of configuration if the camera is remote.</p> </td> </tr> </table> <table border="1" data-bbox="477 1318 1412 1402"> <tr> <td data-bbox="477 1318 714 1402">Keep alive</td> <td data-bbox="714 1318 1412 1402">Sets the timing for a keep alive message to check the link between the Phoenix system and the source. The default setting is 55 seconds. The maximum setting is 60 seconds.</td> </tr> </table>	Source Address (name or IP)	The DNS name or IP address of the source. To use a DNS name, the DNS name must be set using the Edit Node page. Refer to How to Edit a Node, page 87.	Port	The port number associated with the IP address of the source. The default value is 554, except for QUADT; the default value for QUADT is 8554.	Video File Name	<p>User-defined name for the file. This is a required field. The file name is set by the manufacturer (for example: axis-media/media.amp?videocodec=h264&audio=1).</p> <p>For Phoenix Quad-T sources (Protocol Type is set to QUADT), use the following video file names for each source connected to a HDMI connector:</p> <table border="1" data-bbox="743 898 1273 1058"> <tr> <td>v1</td> <td>HDMI 1 connector</td> </tr> <tr> <td>v2</td> <td>HDMI 2 connector</td> </tr> <tr> <td>v3</td> <td>HDMI 3 connector</td> </tr> <tr> <td>v4</td> <td>HDMI 4 connector</td> </tr> </table> <p>Here is a useful link to a list of IP camera sites: http://www.soleratec.com/rtsp/</p> <p> If you do not have the file for your device, search the manufacturer’s Web site for the device and model. The information for each device should be available; if it is not, contact the manufacturer. Copy the file name to a text file for ease of configuration if the camera is remote.</p>	v1	HDMI 1 connector	v2	HDMI 2 connector	v3	HDMI 3 connector	v4	HDMI 4 connector	Keep alive	Sets the timing for a keep alive message to check the link between the Phoenix system and the source. The default setting is 55 seconds. The maximum setting is 60 seconds.
Source Address (name or IP)	The DNS name or IP address of the source. To use a DNS name, the DNS name must be set using the Edit Node page. Refer to How to Edit a Node, page 87.																
Port	The port number associated with the IP address of the source. The default value is 554, except for QUADT; the default value for QUADT is 8554.																
Video File Name	<p>User-defined name for the file. This is a required field. The file name is set by the manufacturer (for example: axis-media/media.amp?videocodec=h264&audio=1).</p> <p>For Phoenix Quad-T sources (Protocol Type is set to QUADT), use the following video file names for each source connected to a HDMI connector:</p> <table border="1" data-bbox="743 898 1273 1058"> <tr> <td>v1</td> <td>HDMI 1 connector</td> </tr> <tr> <td>v2</td> <td>HDMI 2 connector</td> </tr> <tr> <td>v3</td> <td>HDMI 3 connector</td> </tr> <tr> <td>v4</td> <td>HDMI 4 connector</td> </tr> </table> <p>Here is a useful link to a list of IP camera sites: http://www.soleratec.com/rtsp/</p> <p> If you do not have the file for your device, search the manufacturer’s Web site for the device and model. The information for each device should be available; if it is not, contact the manufacturer. Copy the file name to a text file for ease of configuration if the camera is remote.</p>	v1	HDMI 1 connector	v2	HDMI 2 connector	v3	HDMI 3 connector	v4	HDMI 4 connector								
v1	HDMI 1 connector																
v2	HDMI 2 connector																
v3	HDMI 3 connector																
v4	HDMI 4 connector																
Keep alive	Sets the timing for a keep alive message to check the link between the Phoenix system and the source. The default setting is 55 seconds. The maximum setting is 60 seconds.																
Supports ONVIF	<p>Check box to indicate if the source is ONVIF compatible. When selected, the URL for the device must be entered.</p> <p>If ONVIF devices are supported, use the Phoenix Import Utility to discovery the devices on your network.</p>																
Use Anonymous Authentication	<p>Check box to use anonymous authentication for the source.</p> <p>If selected, the source must have a user account with anonymous access enabled.</p> <p>If cleared, a user name and password must be provided to access the source. Contact your system administrator for the source for a valid user name and password.</p>																
Force Unicast (disable multicast)	<p>Check box to enforce unicast transmission only and disable multicasting.</p> <p>If selected, communication with the source is limited to unicast messaging.</p> <p>If cleared, communication with the source uses multicast messaging.</p>																
Audio Allowed	<p>Check box to enable audio for the source. When enabled, a speaker icon is displayed in the Capabilities Allowed field on the Source Profile page. Also, refer to Configure Audio for a Wall, page 174.</p>																

Table 7 — RTSP Fields

Field	Description
Directory Groups	Used to select the Directory Groups for this source. A source can be added to 10 groups. To remove a source from a group, select  .

How to Install the Phoenix Import Utility

To install the utility:

1. Launch the Phoenix Web Manager software (refer to [Access the Web Manager](#), page 45).

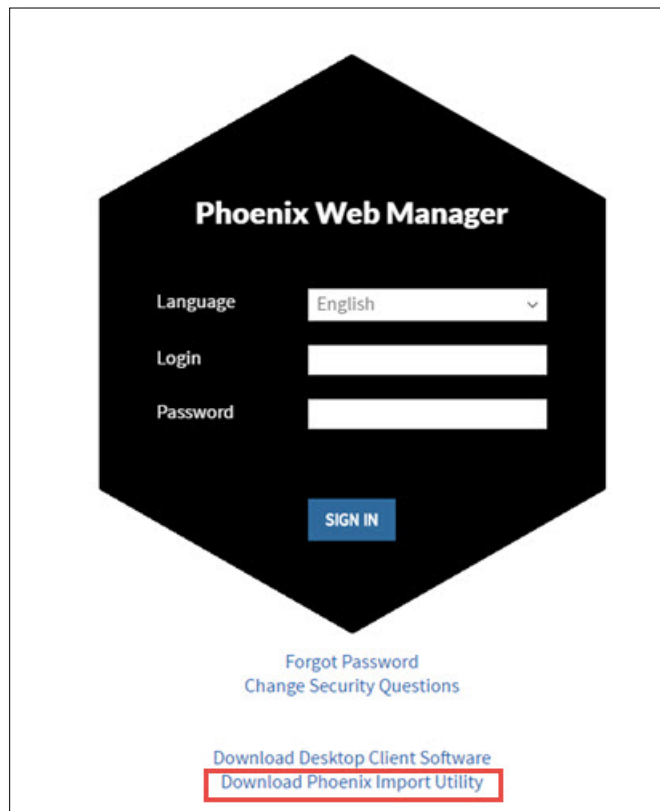

2. Click **Download Phoenix Import Utility** to download it. Follow the prompts from your browser to complete the download.
3. Extract the .exe file from the .zip file.

How to Integrate Phoenix with a Milestone XProtect Video Management System

Milestone XProtect Corporate (2014 or greater) H.264 camera sources are supported with Phoenix software version 1.5 or greater. These sources are viewable on walls only; they are not viewable using the Phoenix Desktop Client.



Each node can transcode a maximum of two Milestone sources.

Complete the following tasks to integrate Milestone sources:

1. Connect to the Milestone management server. Refer to [How to Connect to a Milestone Server](#), page 137.
2. Use the Phoenix Import Utility to retrieve camera data from the Milestone management server. Refer to [How to Find ONVIF or Milestone XProtect Sources](#), page 62.
3. Create layouts for the Phoenix walls that will be used for the Milestone events. Refer to [How to Create a Wall Layout](#), page 159.
4. Create user-defined events in Milestone that you want to trigger a recall of Phoenix system layouts.
5. Map the Milestone events to specified Phoenix wall layouts. When the event occurs, the layout is recalled on the specified wall. Refer to [How to Map Milestone Events to Phoenix Wall Layouts](#), page 138.

How to Find ONVIF or Milestone XProtect Sources

The Phoenix Import Utility can be used to find ONVIF and Milestone XProtect compatible devices on your network. The utility has to be run on a device attached to the same VLAN as the compatible devices. If the devices are on multiple VLANs, run the utility on each VLAN.



Milestone source settings must support H.264 and RTSP/RTP/TCP. Use the Milestone Management Client to set the Streaming Mode to RTP/RTSP/TCP and the Codec to H.264.

To start the Phoenix Import Utility on your PC:

1. Double-click **PhoenixImportUtility.exe**.

When the utility starts, the following window is displayed:

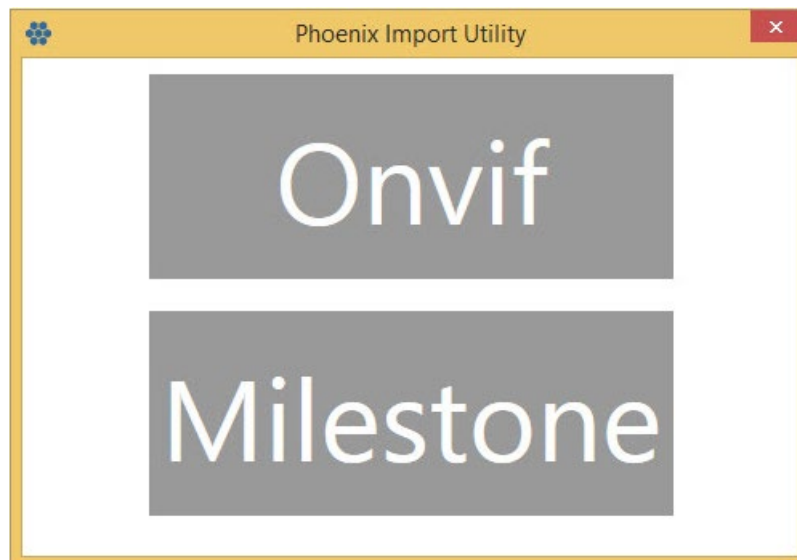

2. Click the desired device type.
 - If you selected ONVIF, the following window is displayed:

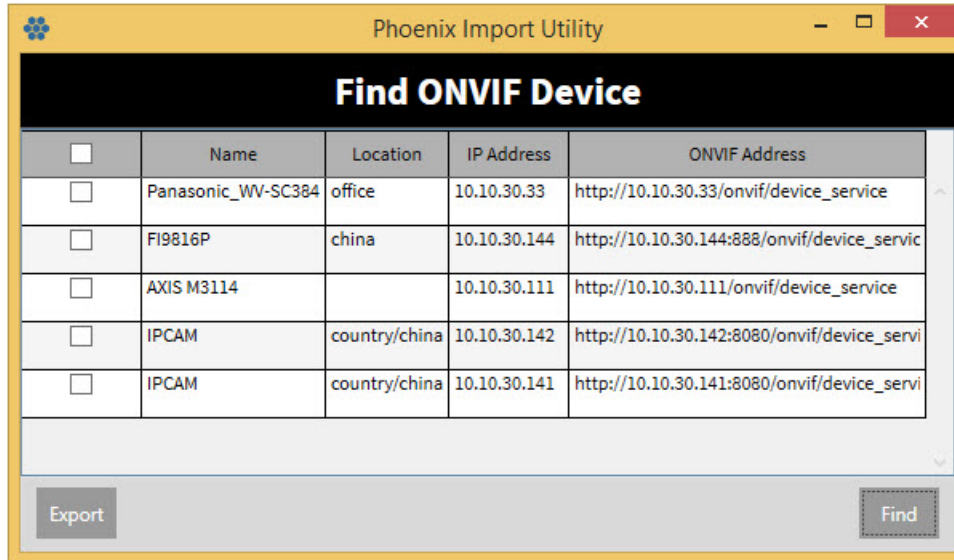

- If you selected Milestone, the following window is displayed and you must provide the server name and your credentials and click **OK**:

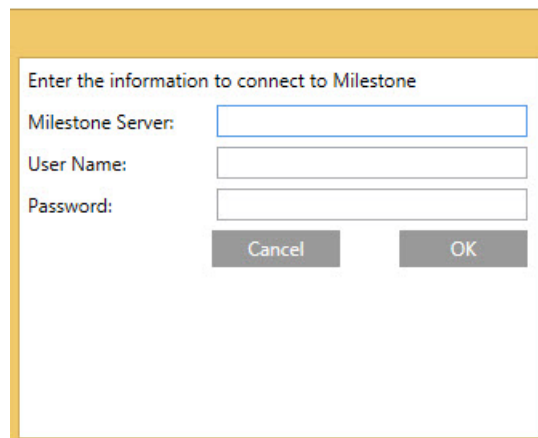

3. Click **Find** to find the compatible devices on your network (on the same VLAN). A list of devices is displayed. See the following examples.

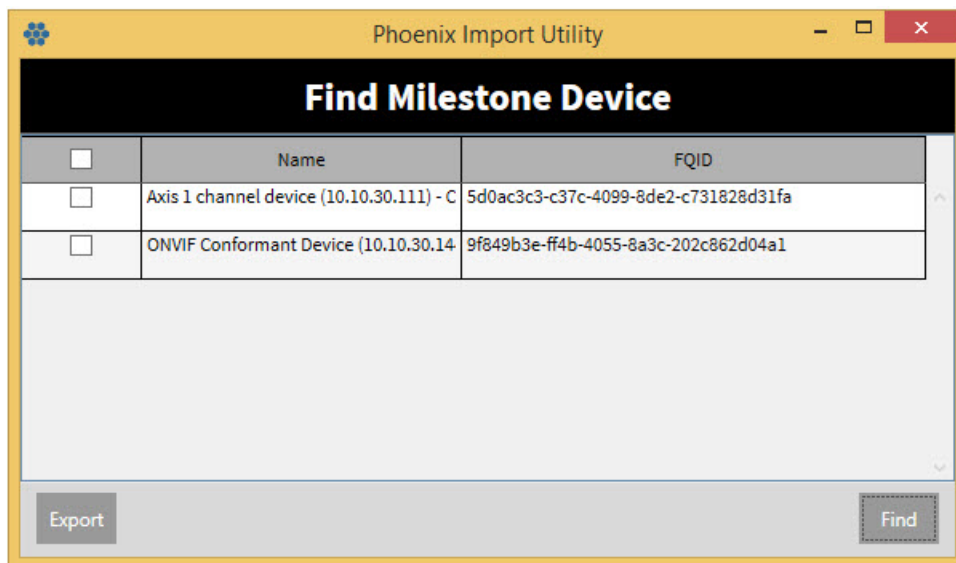
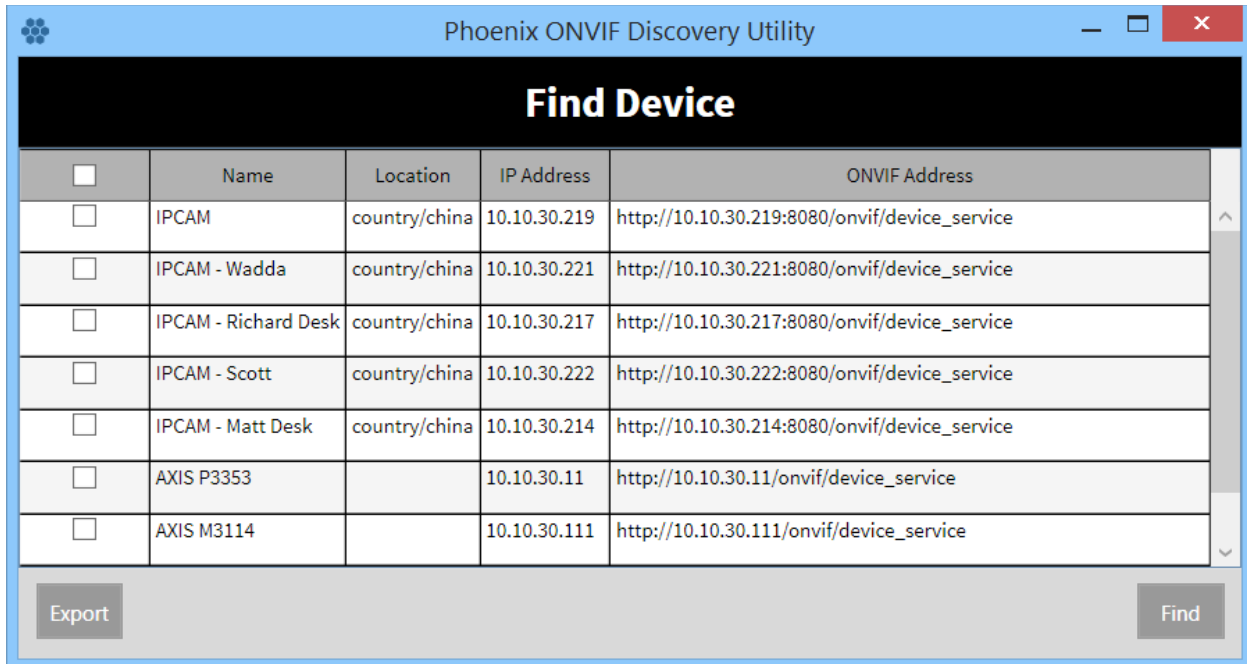

4. Select the check box next to each device you want to export; or select the check box in the first column header to select all devices.

i To import the devices as RTSP sources, each device must have a unique name. If the name is not unique, the device will not be imported.

5. Select **Export**.

6. Do one of the following:

- If the compatible devices are secured with a user name and password, enter the User Name and Password, and then click **OK**.

i Make sure to use the device user name and password. The authentication credentials may be different than the RTSP credentials.

- To find all devices, do not enter User Name and Password, and then click **OK**.

The devices that cannot be exported with the supplied user name and password are highlighted in red.

7. To export the validated devices, click **Yes**.



A warning pop up is displayed if any of the sources do not have valid credentials. Check the credentials and try again.

8. Save the file.
9. Import into Phoenix using the **Import Sources** link in the RTSP Stream Source List. Refer to [How to Bulk Edit Sources](#), page 79.

How to

How to Add a VNC Source

What you need: PC running TightVNC software and a valid user name and password to access the PC. The user needs the appropriate security clearance. Contact your network administrator for this information.



RealVNC software is not supported.

What is supported with this source type: video and interaction with the PC



Phoenix does not support configuring two different VNC sources with the same computer as their destination.

VNC enables you to remotely control a computer using VNC software even if another user is accessing the PC at the same time (share a session). VNC is a 3rd party platform-independent software that consists of a server and a client application. The software must be installed on both computers and it must be using RFB (remote framebuffer) protocol version 3.7 or higher.

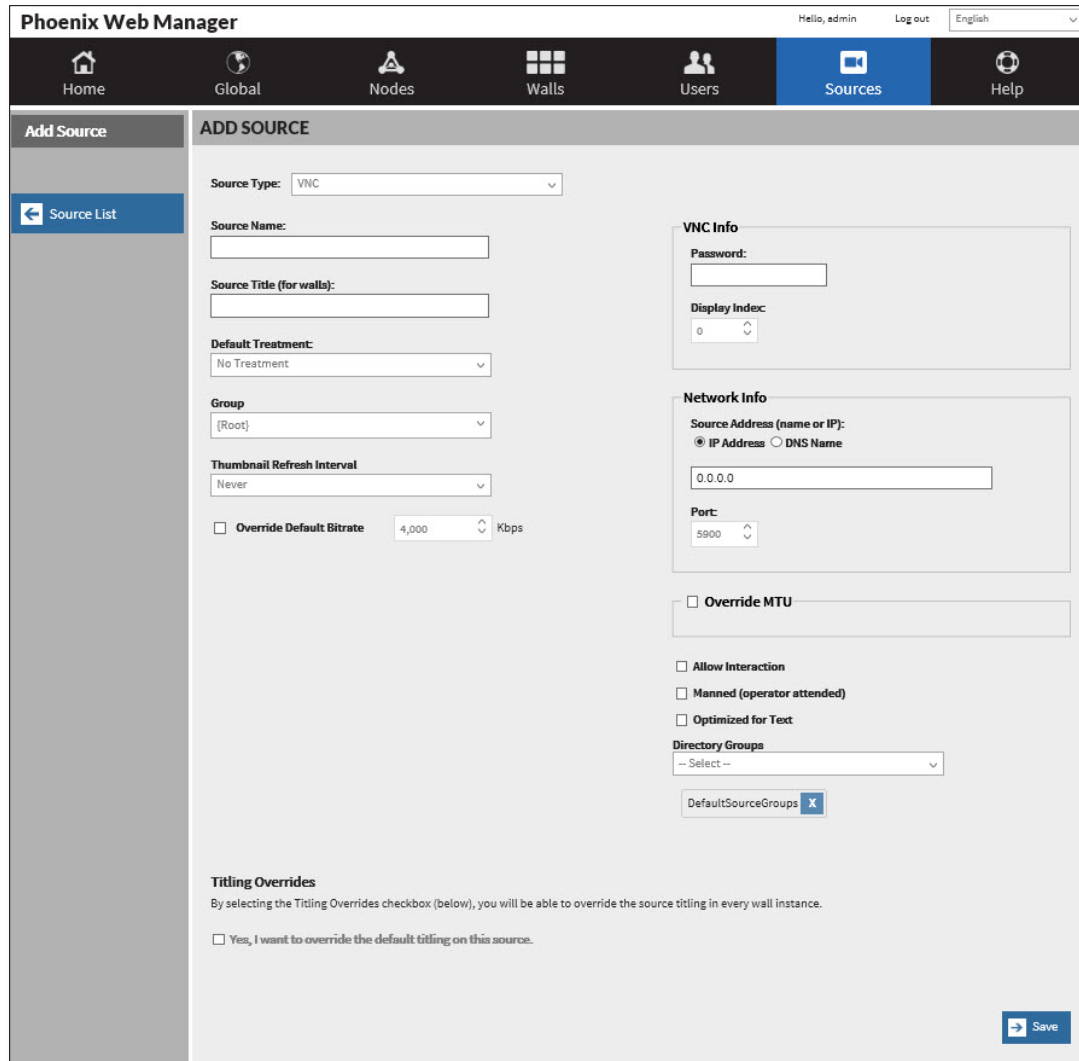







Figure 17 - Add VNC Source

1. In the Source Type field, click VNC to add a PC using the VNC protocol as the source.
2. Configure the details using the information in the following table.
3. If desired, configure the titling overrides for all walls. Refer to [How to Create Titling Overrides](#) (page 77).
4. Click **Save**.

Table 8 – VNC Fields

Field	Description
Source Type	VNC.
Source Name	User-defined name for the source, maximum of 20 characters. This is a required field and will help you identify the source in the list of sources.
Source Title (for walls)	User-defined title for the source, maximum of 20 characters. This is an optional field and will help you identify the source in the list of sources and on walls.

Table 8 – VNC Fields

Field	Description				
Default Treatment	<p>Default treatments are populated by treatments that have been created by users.</p> <p> When setting up a new system there will be no default treatments available. After the treatments are created, a source can be edited to apply a treatment.</p>				
Group	<p>Creates a folder in the source list in the Desktop Client and adds the source to the folder; or if the folder exists, adds the source to an existing folder. Groups are used to organize sources into folders in the Desktop Client.</p>				
Thumbnail Refresh Interval	<p>Refresh interval for updating thumbnails on the Sources list and on the wall simulator in the Desktop Client. Valid values are never, less frequently (every 75 seconds), normal (every 60 seconds), or more frequently (every 45 seconds).</p> <p> These times can vary based on the number of sources you have configured.</p>				
Override Default Bitrate	<p>Check box to enable an override of the default bitrate. When selected, specify the bitrate for the source. The valid range is 0-20 Mbps. The default value is 4000 Kbps. The default bitrate can be viewed on the System Settings page (refer to How to Set Encoding Defaults, page 119).</p>				
VNC Info	<table border="1"> <tr> <td>Password</td> <td>Password to access the VNC source.</td> </tr> <tr> <td>Display Index</td> <td>The number related to the display attached to the VNC source. For example, if the VNC source has more than one display, this number specifies the display to encode. Valid values start at 0 and increase by 1 for each display attached.</td> </tr> </table>	Password	Password to access the VNC source.	Display Index	The number related to the display attached to the VNC source. For example, if the VNC source has more than one display, this number specifies the display to encode. Valid values start at 0 and increase by 1 for each display attached.
	Password	Password to access the VNC source.			
Display Index	The number related to the display attached to the VNC source. For example, if the VNC source has more than one display, this number specifies the display to encode. Valid values start at 0 and increase by 1 for each display attached.				
Network Info	<p>Specifies the network location of the VNC source.</p> <table border="1"> <tr> <td>Address</td> <td>The IP address of the VNC source.</td> </tr> <tr> <td>Port</td> <td>The port number associated with the IP address of the remote desktop. The default port is 5900.</td> </tr> </table>	Address	The IP address of the VNC source.	Port	The port number associated with the IP address of the remote desktop. The default port is 5900.
Address	The IP address of the VNC source.				
Port	The port number associated with the IP address of the remote desktop. The default port is 5900.				
Override MTU	<p>Check box to override the global setting for MTU. When selected, select a new value from the drop down list to set the value for this source only.</p>				
Allow Interaction	<p>Check box to enable a user to interact with the source. For additional information, refer to Interaction Mode, page 176.</p> <p>When interaction mode is enabled for a source, a USB icon is displayed in the Capabilities Allowed field on the Source Profile page.</p> <p>For VNC sources, no additional cabling is required other than a network connection.</p>				
Manned	<p>Check box to indicate the source is monitored by a person. When enabled, a person () icon is displayed in the Manned field on the Source Profile page.</p>				
Optimized for Text	<p>Used to enhance text on displays.</p> <p> This setting should not be used without guidance from Christie support personnel. When set, it can lead to high streaming data rates that stress the network.</p> <p>To enable this feature, the Controller must be manually restarted.</p>				
Directory Groups	<p>Used to select the Directory Groups for this source. A source can be added to 10 groups.</p> <p>To remove a source from a group, select .</p>				



Session sharing should be enabled on the VNC source.
 If you have more than one monitor attached to the PC you are connecting to, make sure two different ports are configured.

Refer to the following for the settings for TightVNC software (other software should have similar settings):

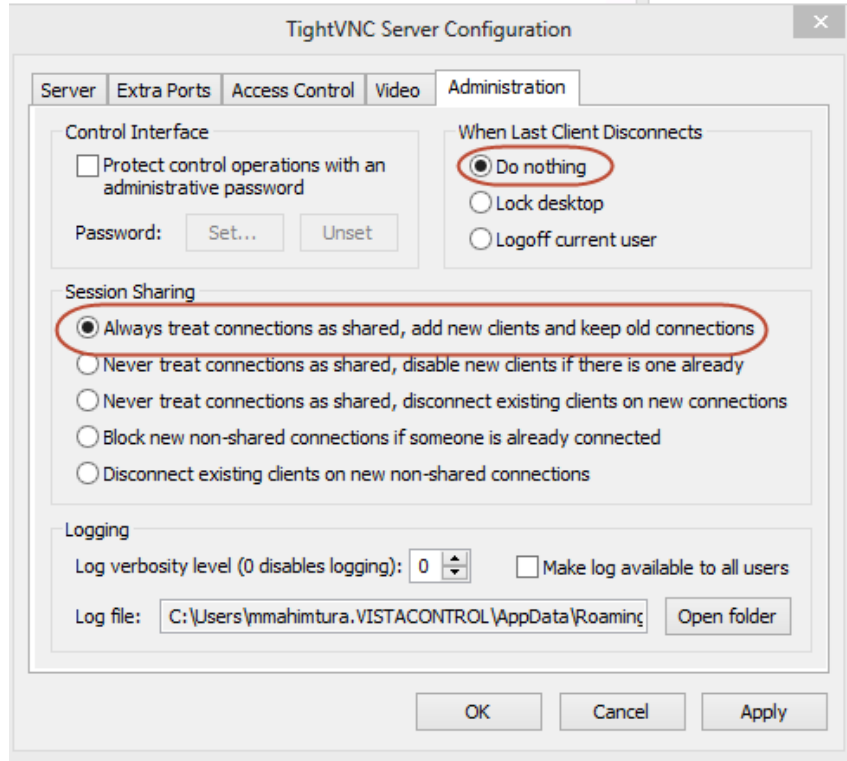

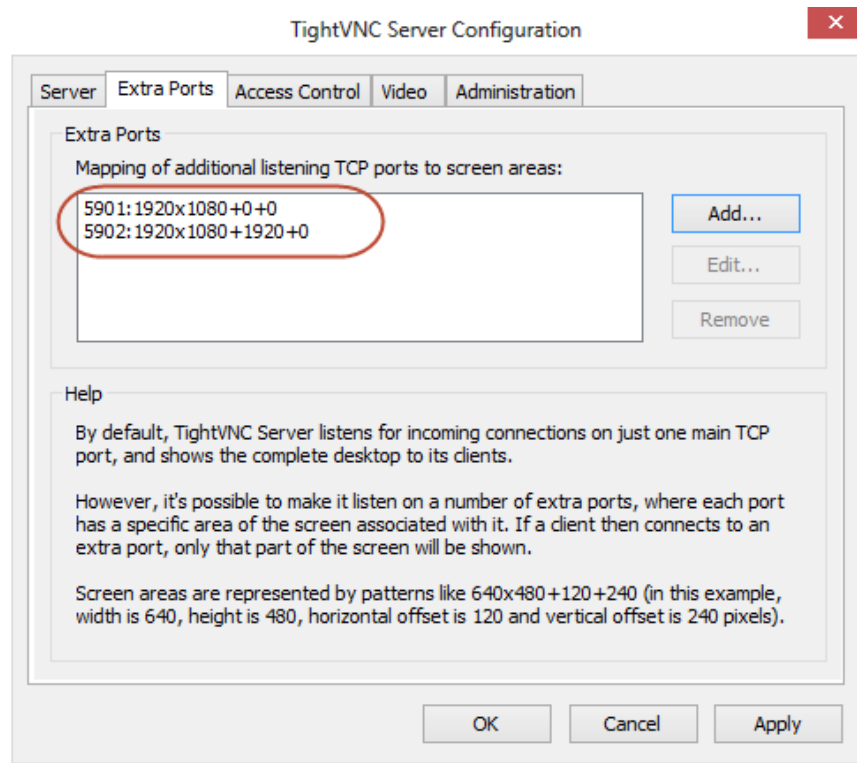

Sharing Multiple Monitors using a TightVNC Server

You can share workstations that use multiple monitors to a Phoenix video wall using a TightVNC Server running on your computer. This is useful for low-motion computer screens when a DVI cable cannot be connected between the source computer and the Phoenix system.

To do this, verify the following:

1. Ensure the TightVNC Server Configuration Settings are configured to include Incoming Viewer Connections and Control Interview passwords.
2. After the Settings are set up on TightVNC Server Configuration Settings dialog, restart the Server and then start the TightVNC Service.

Restrictions

- To share a sources, it must not exceed 1920 x 1200.
- Each Phoenix node can transcode a maximum of two VNC sources.
- If a source computer is using multiple monitors, extra ports (extra monitors) must be configured on the VNC Server to share the monitor on the Phoenix video wall.

To configure Phoenix:

1. Download TightVNC Server from <http://www.tightvnc.com/download.php>.
2. Verify the screen resolution and settings of the monitor(s) you want to share.
3. Verify the IP address of the source computer.
4. Configure the TightVNC Server's extra ports. See the following example for a desktop workstation that uses four screens arranged in a 2x2 array producing a resolution of 3840x2160.

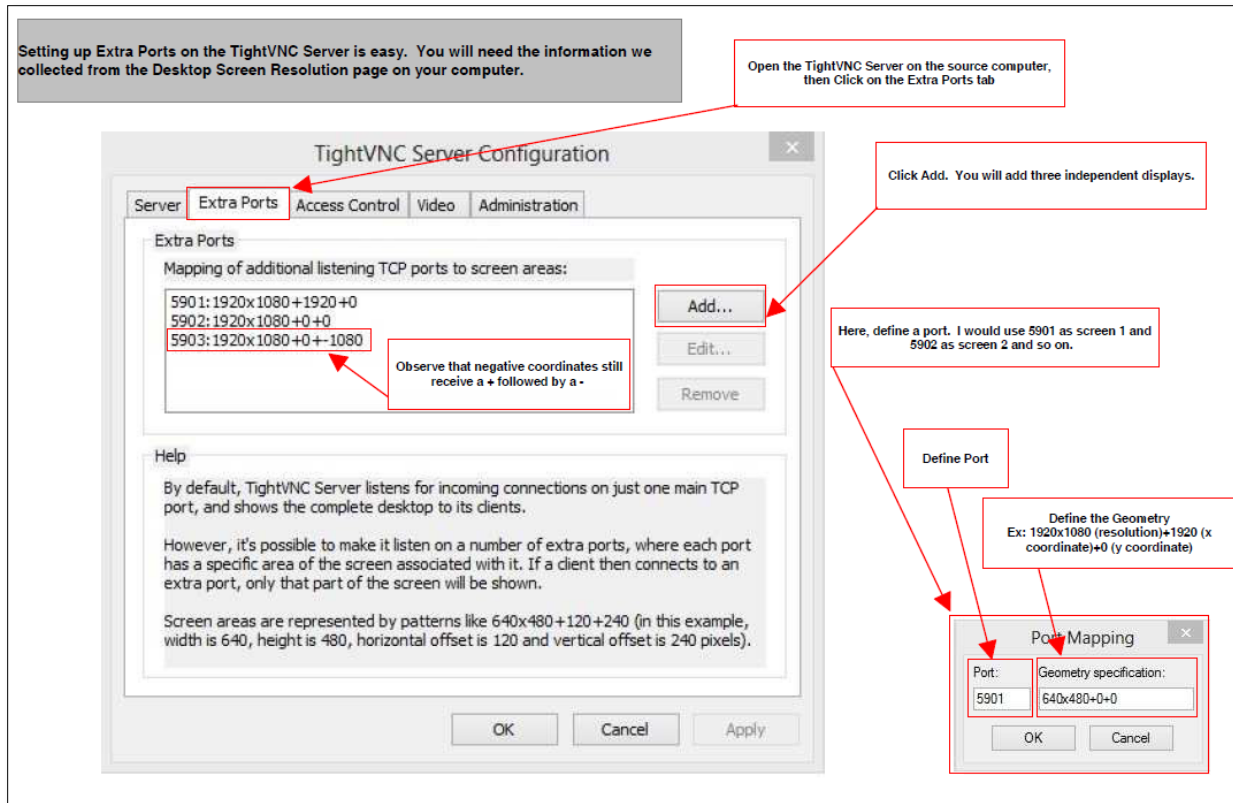

- Configure the VNC source in the Phoenix Web Manager. In the VNC Info pane, select the password you configured on your VNC Server; enter the IP address of the source computer; enter the port of the monitor you want to share.

How to Add a Remote Desktop Source

What you need: PC running Remote Desktop Protocol and a valid user name and password to access the PC. The user needs the appropriate security clearance. Contact your network administrator for this information.

What is supported with this source type: video and interaction with the PC.

A remote desktop source enables you to access a remote computer that is on the network using Microsoft Remote Desktop Protocol (RDP).

This protocol is built into Windows, treats each connection as a new session, and limits the number of connections (usually 1). Remote desktop is faster than VNC, and provides more control on who connects and what they can do.

To connect to a remote computer, that computer must be turned on, it must have a network connection, Remote Desktop must be enabled, you must have network access to the remote computer, and you must have permission to connect to the computer. Once connected to the computer, you can access all its programs and files (e.g., view a PowerPoint presentation, display graphics, etc.).

Phoenix Web Manager Hello, admin Log out English

Home Global Nodes Walls Users **Sources** Help

ADD SOURCE

Source Type: Remote Desktop

Source Name:

Source Title (for walls):

Default Treatment: No Treatment

Group: [Root]

Thumbnail Refresh Interval: Never

Override Default Bitrate 4,000 Kbps

Remote Desktop Info

User Name:

Password:

Network Info

Source Address (name or IP):
 IP Address DNS Name

Port: 3389

Override MTU

Allow Interaction
 Manned (operator attended)
 Optimized for Text

Directory Groups: -- Select --

DefaultSourceGroups X

Titling Overrides
 By selecting the Titling Overrides checkbox (below), you will be able to override the source titling in every wall instance.

Yes, I want to override the default titling on this source.

Save

Figure 18 – Adding a Remote Desktop Source

1. On the PC you want to connect to, verify the system properties settings allow for remote connections. See the following:

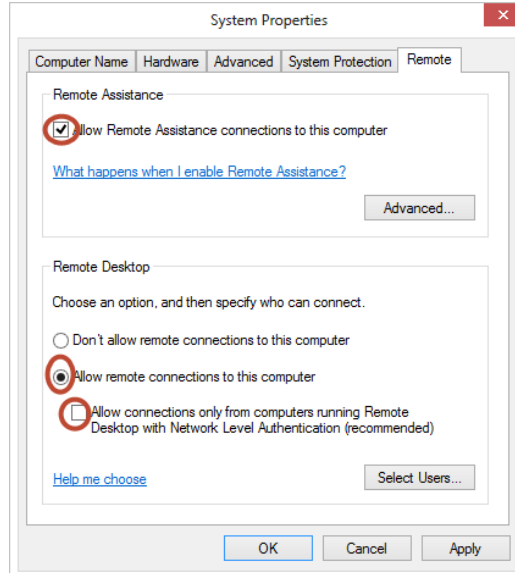

i Make sure the *Allow Connections only from computers running Remote Desktop with Network Level Authentication* check box is not selected.

- In the **Source Type** field, click **Remote Desktop** to add a source that is a remote desktop not directly connected to the Phoenix system.



i The computer must be on the same LAN as the Phoenix node.

- Configure the details using the information in the following table.
- If desired, configure the titling overrides for all walls. Refer to How to Create Titling Overrides (page 77).
- Click Save.

Table 9 – Remote Desktop Fields

Field	Description
Source Type	Remote Desktop.
Source Name	User-defined name for the source, maximum of 20 characters. This is a required field and will help you identify the source in the list of sources.
Source Title (for walls)	User-defined title for the source, maximum of 20 characters. This is an optional field and will be displayed on a wall if titling is enabled.
Default Treatment	Default treatments are populated by treatments that have been created by users. i When setting up a new system there will be no default treatments available. After the treatments are created, a source can be edited to apply a treatment.
Group	Creates a folder in the source list in the Desktop Client and adds the source to the folder; or if the folder exists, adds the source to an existing folder. Groups are used to organize sources into folders in the Desktop Client.
Thumbnail Refresh Interval	Refresh interval for updating thumbnails on the Sources list and on the wall simulator in the Desktop Client. Valid values are never, less frequently (every 75 seconds), normal (every 60 seconds), or more frequently (every 45 seconds). i These times can vary based on the number of sources you have configured.

Table 9 — Remote Desktop Fields

Field	Description				
Override Default Bitrate	Check box to enable an override of the default bitrate. When selected, specify the bitrate for the source. The valid range is 0-20 Mbps. The default value is 4000 Kbps. The default bitrate can be viewed on the System Settings page (refer to How to Set Encoding Defaults , page 119).				
Remote Desktop Info	<p>User Name User name to log into the remote desktop.</p> <p>Password Password for the user name.</p>				
Network Info	<p>Network location of the remote desktop.</p> <table border="1"> <tr> <td>Address</td> <td>The IP address of the remote desktop. Valid format is IPv4.</td> </tr> <tr> <td>Port</td> <td>The port number associated with the IP address of the remote desktop.</td> </tr> </table>	Address	The IP address of the remote desktop. Valid format is IPv4.	Port	The port number associated with the IP address of the remote desktop.
Address	The IP address of the remote desktop. Valid format is IPv4.				
Port	The port number associated with the IP address of the remote desktop.				
Override MTU	Check box to override the global setting for MTU. When selected, select a new value from the drop down list to set the value for this source only.				
Allow Interaction	<p>Check box to enable a user to interact with the source. For additional information, refer to Interaction Mode, page 176.</p> <p>When interaction mode is enabled, a USB icon is displayed in the Capabilities Allowed field on the Source Profile page.</p> <p>For Remote Desktop sources, no additional cabling is required other than a network connection.</p>				
Manned (operator attended)	Check box to indicate the source is monitored by a person. When enabled, a person () icon is displayed in the Manned field on the Source Profile page.				
Optimized for Text	<p>Used to enhance text on displays.</p> <div style="border: 1px solid gray; border-radius: 50%; width: 40px; height: 40px; display: flex; align-items: center; justify-content: center; margin: 10px 0;"> i </div> <p>This setting should not be used without guidance from Christie support personnel. When set, it can lead to high streaming data rates that stress the network.</p> <p>To enable this feature, the Controller must be manually restarted.</p>				
Directory Groups	<p>Used to select the Directory Groups for this source. A source can be added to 10 groups.</p> <p>To remove a source from a group, select .</p>				

How to Add a Still Source

What you need: An image file available on the network.

What is supported with this source type: still image.

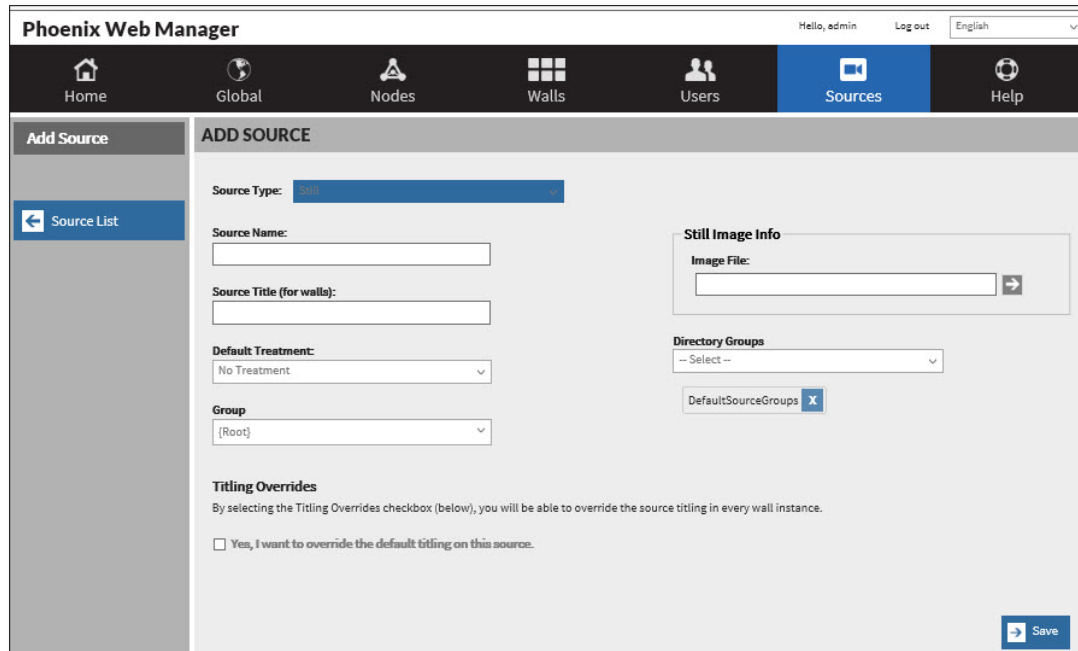

Figure 19 – Add Still Source

1. In the **Source Type** field, click **Still** to add a still image as the source.
2. Configure the details using the information in Table 10.
3. If desired, configure the titling overrides for all walls. Refer to [How to Create Titling Overrides](#) (page 75) for details.
4. Click **Save** to save the file to the controller.

Table 10 – Still Fields

Field	Description		
Source Type	Still.		
Source Name	User-defined name for the source, maximum of 20 characters. This is a required field and will help you identify the source in the list of sources.		
Source Title (for walls)	User-defined title for the source, maximum of 20 characters. This is an optional field and will help you identify the source in the list of sources and on walls.		
Default Treatment	Default treatments are populated by treatments that have been created by users. <div style="display: flex; align-items: center;"> <div style="border: 1px solid gray; border-radius: 50%; width: 30px; height: 30px; display: flex; align-items: center; justify-content: center; margin-right: 10px;">i</div> <p>When setting up a new system there will be no default treatments available. After the treatments are created, a source can be edited to apply a treatment.</p> </div>		
Group	Creates a folder in the source list in the Desktop Client and adds the source to the folder; or if the folder exists, adds the source to an existing folder. Groups are used to organize sources into folders in the Desktop Client.		
Still Image Info	<table border="1" style="width: 100%; border-collapse: collapse;"> <tr> <td style="width: 20%;">Image File</td> <td>Select the file name that identifies the still image. Valid formats are BMP, JPEG, PNG, or TIFF.</td> </tr> </table>	Image File	Select the file name that identifies the still image. Valid formats are BMP, JPEG, PNG, or TIFF.
Image File	Select the file name that identifies the still image. Valid formats are BMP, JPEG, PNG, or TIFF.		
Active Directory Groups	Used to select the Active Directory Groups for this source. A source can be added to 10 groups. To remove a source from a group, select x .		

How to Add an Application Source

What you need: A URL or an executable program (e.g. excel.exe) for the web page and a virtual machine (Windows Server version 2008 and higher) to support the source.

What is supported with this source type: Running an executable or a Web page running in Internet Explorer in kiosk mode (this mode prevents users from accessing other web pages by running in Full Screen mode where the Internet Explorer title bar, menus, toolbars, and status bar are not displayed).

The screenshot shows the 'ADD SOURCE' configuration page in the Phoenix Web Manager. The interface includes a top navigation bar with icons for Home, Global, Nodes, Walls, Users, Sources, and Help. The 'Sources' tab is active. On the left, there is a sidebar with 'Add Source' and 'Source List' options. The main content area is titled 'ADD SOURCE' and contains the following fields and options:





- Source Type:** A dropdown menu set to 'Application'.
- Source Name:** A text input field with 'Required' entered.
- Source Title (for walls):** A text input field with 'Optional' entered.
- Default Treatment:** A dropdown menu set to 'No Treatment'.
- Group:** A dropdown menu set to '{Root}'.
- Thumbnail Refresh Interval:** A dropdown menu set to 'Never'.
- Override Default Bitrate:** A checkbox (unchecked) followed by a spinner box set to '3,999' and the unit 'Kbps'.
- Application Configuration:** A section containing:
 - Website URL:** A text input field.
 - Override default command:** A checkbox (unchecked).
 - Override MTU:** A checked checkbox followed by a dropdown menu set to '1316'.
 - Allow Interaction:** A checkbox (unchecked).
 - Manned (operator attended):** A checkbox (unchecked).
- Titling Overrides:** A section with a paragraph: "By selecting the Titling Overrides checkbox (below), you will be able to override the source titling in every wall instance." and a checkbox (unchecked) labeled "Yes, I want to override the default titling on this source."

A blue 'Save' button is located at the bottom right of the form.

Figure 20 – Add Application Source

1. Verify you have a Virtual Machine set up to support the application source you are creating. Refer to [How to Add a Virtual Machine, page 138](#).
2. In the **Source Type** field, click **Application**.
4. Configure the details using the information in the following table.
5. If desired, configure the titling overrides for all walls. Refer to for details.
6. Click **Save**.

Table 11 – Application Source Fields

Field	Description
Source Type	Application.
Source Name	User-defined name for the source, maximum of 20 characters. This is a required field and will help you identify the source in the list of sources.
Source Title (for walls)	User-defined title for the source, maximum of 20 characters. This is an optional field and will help you identify the source in the list of sources and on walls.
Default Treatment	<p>Default treatments are populated by treatments that have been created by users.</p> <p> When setting up a new system there will be no default treatments available. After the treatments are created, a source can be edited to apply a treatment.</p>
Group	Creates a folder in the source list in the Desktop Client or adds the source to an existing folder. Groups are used to organize sources into folders in the Desktop Client.
Thumbnail Refresh Interval	<p>Refresh interval for updating thumbnails on the Sources list and on the wall simulator in the Desktop Client. Valid values are never, less frequently (every 75 seconds), normal (every 60 seconds), or more frequently (every 45 seconds).</p> <p> These times can vary based on the number of sources you have configured.</p>
Application Configuration	<p>Website URL or Command</p> <p>The web address for the Website or a command to run a specified application/program stored on a virtual machine.</p> <p> This field is renamed to <i>Command</i> when the <i>Override default command</i> check box is selected.</p>
	<p>Override default command</p> <p>The default command is: <code>iexplore -k URL</code> To override this, select this checkbox. Selecting this checkbox enables you to run a program (e.g., Microsoft Office programs, third-party software, and other executable programs) on a virtual machine (e.g., <code>excel.exe</code> runs Excel when the source is accessed).</p>
Override MTU	Check box to override the global setting for MTU. When selected, select a new value from the drop down list to set the value for this source only.
Allow Interaction	<p>Check box to enable a user to interact with the source. For additional information, refer to Interaction Mode, page 176.</p> <p>When interaction mode is enabled, a USB icon is displayed in the Capabilities Allowed field on the Source Profile page.</p> <p>For Application sources, no additional cabling is required other than a network connection.</p>
Manned (operator attended)	Check box to indicate the source is monitored by a person. When enabled, a person () icon is displayed in the Manned field on the Source Profile page.
Active Directory Groups	<p>Used to select the Active Directory Groups for this source. A source can be added to 10 groups.</p> <p>To remove a source from a group, select .</p>

How to Create Titling Overrides

Titling overrides are used to prevent titles of sources from being changed. If this feature is enabled, you can specify how the titling should be formatted for a source and the titling won't change when displayed on a wall.

Titling Overrides
 By selecting the Titling Overrides checkbox (below), you will be able to override the source titling in every wall instance.

Yes, I want to override the default titling on this source.

Copy titling from:

Title Visibility: **Titles On** **Titles Off**

<p><input type="checkbox"/> Font Family: <input type="text" value="Arial"/></p> <p><input type="checkbox"/> Font Size: <input type="text" value="20"/></p> <p><input type="checkbox"/> Font Color: <input type="text" value="#FFFFFF"/></p> <p><input type="checkbox"/> Font Weight: <input type="text" value="B"/></p> <p><input type="checkbox"/> Font Italic: <input type="text" value="I"/></p> <p><input type="checkbox"/> Font Underline: <input type="text" value="U"/></p>	<p><input type="checkbox"/> Font Background: <input type="text" value="#000000"/></p> <p><input type="checkbox"/> Stroke Color: <input type="text" value="#000000"/></p> <p><input type="checkbox"/> Stroke Thickness: <input type="text" value="px"/></p> <p><input type="checkbox"/> Titling Horizontal Alignment: <input type="text" value="Left"/></p> <p><input type="checkbox"/> Titling Vertical Alignment: <input type="text" value="Top"/></p>
--	---

Figure 21 - Titling Overrides

Table 12 – Titling Overrides

Field	Description
Titling Overrides	Click the check box to enable titling overrides for the following characteristics for a source. To specify each, click the desired individual check boxes and specify the value.
Copy titling from	Select the desired source from the drop down list.
Title Visibility	On, off
Font Family	Select the desired value from the drop down list.
Font Size	Specify the size in points (pts).
Font Color	Input the hex value for the desired font color or use the color selector to specify it.
Font Weight	Used to specify bold font.
Font Italic	Used to specify italic font.
Font Underline	Used to specify underline font.
Font Background	Input the hex value for the desired font background color or use the color selector to specify it.
Stroke Color	Input the hex value for the desired stroke color or use the color selector to specify it.
Stroke Thickness	Specify the stroke thickness in pixels. Valid values are 1-100.
Titling Horizontal Alignment	Click the desired horizontal alignment.
Titling Vertical Alignment	Click the desired vertical alignment.

How to View a Source Profile

To view a source profile:

From the Source List page, point to a source and click.

The source profile includes the source information, attributes, and the current activity for the source. The current activity includes the walls that the source is displayed on and the nodes on the walls that are displaying the source.

How to Edit a Source

From the Edit Source page, you can modify the source configuration and you can update the thumbnail associated with the source.

To edit a source:

1. Click the source in the Source List.
2. Click **Edit Source** in the page navigation pane.
3. Make the desired changes referring to [Table 6](#) through [Table 10](#) for additional information.
4. Click **Save**.

- To edit the notes for a source, click on a source name and enter the new notes, and then click **Save**.

How to Bulk Edit Sources

You can edit multiple sources (except Still Images) using the template that can be downloaded from the Sources page. Additionally, you can bulk edit RTSP sources using a .csv file exported from the Phoenix ONVIF Discovery Utility (refer to [How to Install the Phoenix Import Utility](#), page 61). Bulk editing requires basic experience using Microsoft Excel and an understanding of the fields associated with each source type.

Bulk editing enables you to add, update, and delete sources. The A and B column in the spreadsheet determine the type of edit.

	A Column ID	B Column To Delete
Add	No value (empty cell)	FALSE
Update	Valid value	FALSE
Delete	Valid value	TRUE

In the following example, line 2 is an example of an update, line 3 is an example of a deletion, and line 4 is an example of an addition.

	A	B	C	D	E	F	G	H	I	J	K	L	M	N
1	Id	ToDelete	Name	Title	Default Tri	Group	Thumb Rel	Active Dire	Protocol T	Source Ad	Port	Video File	Keep Alive	Use Anony U
2	74	FALSE	Camera 1	Camera 1		Cameras	Normal		RTSP	eng-de01.	554	axis-media	30	TRUE
3	76	TRUE	Camera 2	Camera 2		Cameras	Normal		RTSP	10.10.30.3	554	axis-media	30	FALSE
4		FALSE	Camera 3	Camera 3		Cameras	Normal		RTSP	10.10.0.55	554	axis-media	30	TRUE

To use this feature, it is best to add at least one source before attempting to bulk edit sources.

To bulk edit sources:

- Backup your system. Refer to [How to Back up the System](#), page 124.
- Click the source type you want to edit from the Source List.

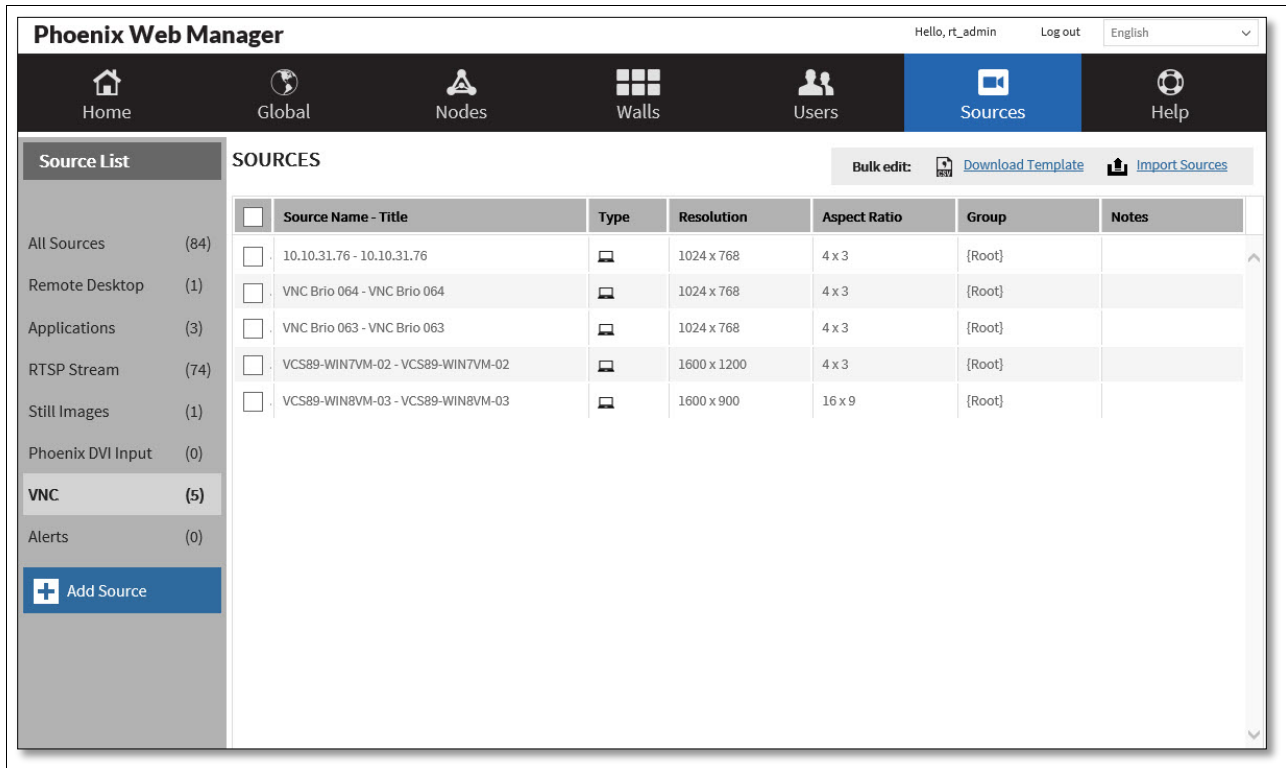

3. Do one of the following:
 - a. Click **Download Template**. The template is downloaded in your browser. The template has a sample entry. Before saving the template, delete the sample entry.
 - b. Click the check box associated with each source you want to edit, and then click **Export CSV**.
4. Edit the existing sources by changing the desired fields or add a new source by completing all the fields except the source ID for the source. The source ID is generated automatically.
5. Click **Import Sources** to upload your changes.

How to Delete a Source

To delete a source:



Sources can only be deleted using the Web Manager (not using the Desktop Client).

1. Click the source in the Source List.
2. Click **Edit Source** in the page navigation pane.
3. Click **Delete** in the page navigation pane.
4. Respond to the confirmation popup to delete the source.

Manage Nodes

To manage nodes, click **Manage Nodes** on the Home page or click **Nodes** in the main navigation area.

Phoenix Web Manager						
Nodes						
Nodes List	Node ID - Node Name	IP Address	Decoding	Encoding	Transcoding	Outputs
All Nodes(29)	00008D - PHOENIX 101	10.10.100.101	60%	0%	0%	1920 x 1080 @ 59...
Controllers(1)	03FF13 - PHOENIX 106	10.10.100.106	60%	0%	0%	1920 x 1080 @ 59...
Decoders(24)	0000ED - PHOENIX 102	10.10.100.102	60%	0%	0%	1920 x 1080 @ 59...
Encoders(24)	040288 - PHOENIX 120	10.10.100.120	60%	20%	0%	1920 x 1080 @ 59...
Transcoders(24)	0000DA - PHOENIX 104	10.10.100.104	60%	0%	0%	1920 x 1080 @ 59...
Un-assigned(2)	0402B8 - PHOENIX 121	10.10.100.121	60%	20%	0%	1920 x 1080 @ 59...
Alerts(0)	0000DB - PHOENIX 118	10.10.100.118	60%	10%	0%	1920 x 1080 @ 59...
	0000DE - PHOENIX 108	10.10.100.108	60%	0%	0%	1920 x 1080 @ 59...
	0000E3 - PHOENIX 116	10.10.100.116	60%	0%	0%	1920 x 1080 @ 59...
	040246 - PHOENIX 103	10.10.100.103	60%	0%	0%	1920 x 1080 @ 59...
	040299 - PHOENIX 119	10.10.100.119	60%	20%	0%	1920 x 1080 @ 59...
	0000DD - PHOENIX 112	10.10.100.112	60%	0%	0%	1920 x 1080 @ 59...
	00008A - PHOENIX 111	10.10.100.111	60%	10%	0%	1920 x 1080 @ 59...
	03FF0A - PHOENIX 107	10.10.100.107	60%	0%	0%	1920 x 1080 @ 59...

Figure 22 – Node List

From this page you can view the status of each node (associated with the icon next to the Node ID), view the profile for an existing node, add a node, display a list of nodes, un-assign a node from a controller, stop decoding on a node, download the details for the nodes, and edit a node.

The status of the node also includes the current amount (in percent) of encoding, decoding, and transcoding being performed by each node; and the resolution of the output for each node (horizontal and vertical) and the frequency of the output (Hz).

The node status can be one of the following:

Connected to a controller and no alerts are active on the node.	No icon
Warning. One or more warning alerts are active on the node.	
Un-assigned. The node is not assigned to a controller.	
Offline. The node is unavailable. The node may be powered off or not connected to the network.	
Critical. One or more critical alerts are active on the node.	

A node can be assigned to a controller when it is in the unassigned state. When unassigned, the un-assigned () icon is displayed next to the node ID in the node list. When a node is installed, it is

automatically recognized (auto detected) by the controller, but it has to be assigned to a controller. Once assigned to a controller, the node is not available to any other controller.

How to View a Node Profile

Click the node in the node list to display the node profile.

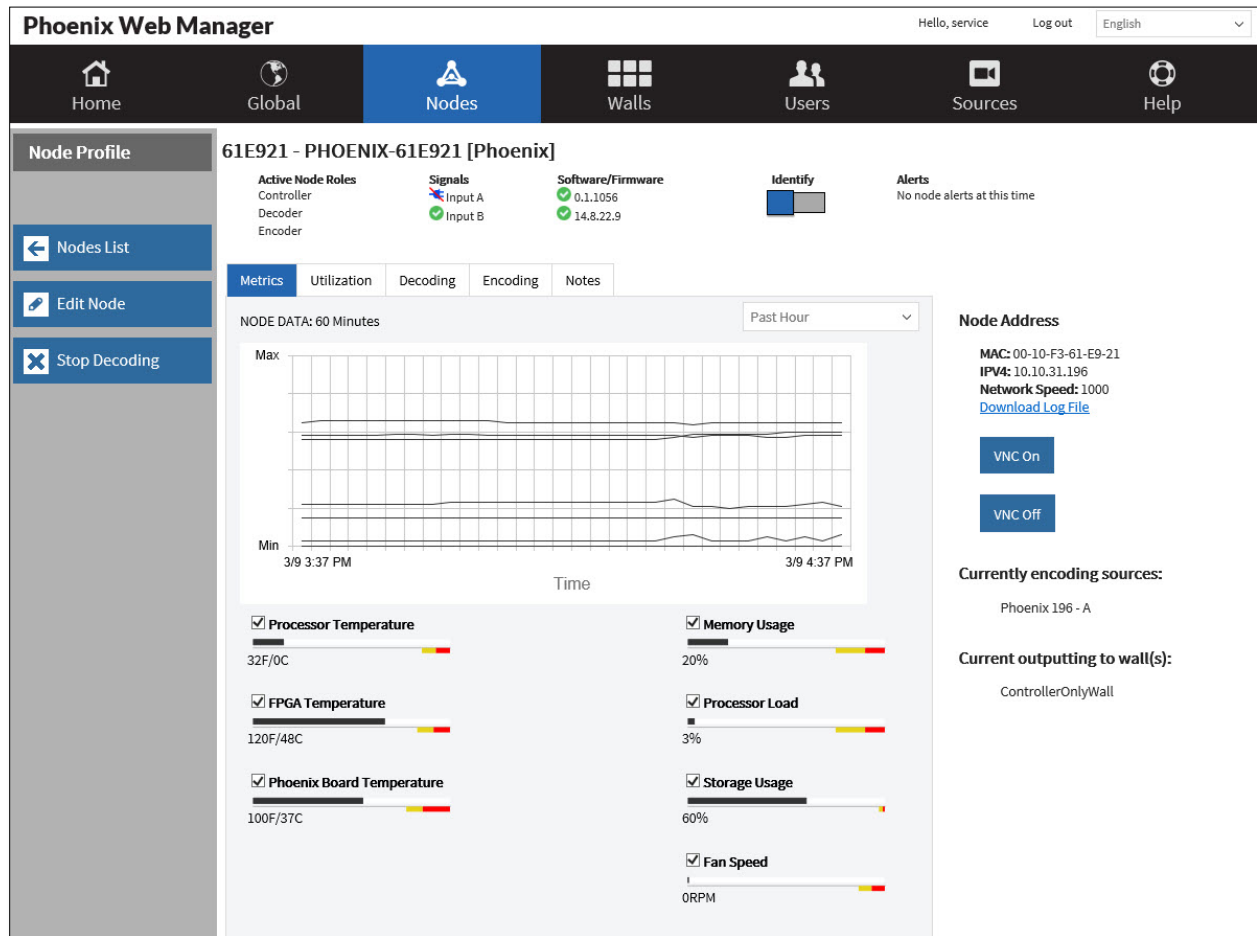

Figure 23 – Node Profile

Table 13 — Node Fields

Field	Description
Node ID	The Node ID and Node Name identify the node. The node ID is assigned during manufacturing (format: 6 alphanumeric serial number) and cannot be changed.
Node Name	The Node name is user-defined and can contain up to 20 characters. The default node name is the serial number. The serial number can be found on the label on the bottom of the node. The serial number is assigned during manufacturing. <div style="display: flex; align-items: center;"> <p>Assign useful names to the nodes to help identify them.</p> </div>

Table 13 — Node Fields





Field	Description						
Active Node Roles	<p>Valid values are:</p> <table border="1"> <tr> <td>Controller</td> <td> <p>Manages the system data and status for all the nodes on the network.</p> <p>The controller role is automatically allowed on every node. The Controller role is assigned using the Phoenix Controller Management Wizard. Refer to Configure a Controller, page 39.</p> </td> </tr> <tr> <td>Decoder</td> <td> <p>Decodes sources and displays the output through the Output A and Output B connectors.</p> </td> </tr> <tr> <td>Encoder</td> <td> <p>Encodes sources connected to the Input A and Input B connectors.</p> </td> </tr> </table> <p> A single Phoenix node can be an encoder, decoder, and controller all at the same time. To assign a node as a controller, use the Controller Manager (refer to Configure a Controller, page 39).</p>	Controller	<p>Manages the system data and status for all the nodes on the network.</p> <p>The controller role is automatically allowed on every node. The Controller role is assigned using the Phoenix Controller Management Wizard. Refer to Configure a Controller, page 39.</p>	Decoder	<p>Decodes sources and displays the output through the Output A and Output B connectors.</p>	Encoder	<p>Encodes sources connected to the Input A and Input B connectors.</p>
Controller	<p>Manages the system data and status for all the nodes on the network.</p> <p>The controller role is automatically allowed on every node. The Controller role is assigned using the Phoenix Controller Management Wizard. Refer to Configure a Controller, page 39.</p>						
Decoder	<p>Decodes sources and displays the output through the Output A and Output B connectors.</p>						
Encoder	<p>Encodes sources connected to the Input A and Input B connectors.</p>						
Signals	The signals detected by the node; Input A and Input B.						
Software/Firmware	Versions for the software and firmware (refer to Software Versioning , page 116).						
Identify	Turns the LED on and off on the front of the node to identify it and displays the node details on the wall.						
Alerts	Current alerts for the node. When there is more than one alert, the alerts automatically scroll; or you can manually scroll through them using the scroll buttons.						
Metrics	<p>Graphical and textual representation of the following diagnostics for a specific timeframe (hour, day, week, or month):</p> <ul style="list-style-type: none"> • Processor Temperature • FPGA Temperature • Phoenix Board Temperature • Memory Usage • Processor Load • Storage Usage • Fan Speed <p>Select the desired timeframe, the desired values to include on the graph by selecting the check box associated with the value, and then hover over the desired indicator (e.g.; temperature or Memory Usage) to highlight the values on the graph. When the results are within the yellow or red range for any of the diagnostics, the LED on the front of the node changes to yellow or red and an alert is displayed on this page. When the results return to within the normal range, the LED changes to blue.</p>						
Utilization	<p>Displays the current percentage of the node’s resources that are being used by each role.</p> <p> If you position your mouse over the pie chart, the percentages are displayed.</p> <p>The icons indicate if one or more sources have Audio () or Interaction () enabled.</p>						

Table 13 — Node Fields

Field	Description								
Encoding	<p>Displays a pie chart illustrating the current percentage of encoding being performed by the node.</p> <p>The Input Settings provide the following details:</p> <ul style="list-style-type: none"> • If one or more sources connected to the Input A or B connectors have Audio (🔊) or Interaction (👁️) enabled. • The resolution of each input. • The percentage of the node’s resources that are being used by the encoding tasks; or for Remote Desktop or VNC sources, the percentage of the node’s resources that are being used by the transcoding tasks. 								
Decoding	<p>Displays the wall the node is decoding on and the resolution for the outputs and the rotation. Each output displays if it is decoding video and audio and its X and Y positions on the wall. The X and Y positions are based on the top left corner of the outputs and the wall.</p>								
Notes	<p>Displays the current user-entered notes and a support contact (if one has been assigned). The Submit button saves the notes and they are displayed in the Nodes List and the Node Profile.</p>								
Node Address	<p>The node address in the network includes the following:</p> <table border="1"> <tr> <td>MAC</td> <td>The MAC address for the node. The valid format is six groups of two hexadecimal digits, separated by hyphens (e.g. 01-23-45-67-89-ab).</td> </tr> <tr> <td>IPv4</td> <td>The Internet Protocol version 4 address for the node. The valid format is: nnn.nnn.nnn.nnn.</td> </tr> <tr> <td>Network speed</td> <td>Displays the current speed of the network.</td> </tr> <tr> <td>Download log files</td> <td>Downloads the system log files.</td> </tr> </table>	MAC	The MAC address for the node. The valid format is six groups of two hexadecimal digits, separated by hyphens (e.g. 01-23-45-67-89-ab).	IPv4	The Internet Protocol version 4 address for the node. The valid format is: nnn.nnn.nnn.nnn.	Network speed	Displays the current speed of the network.	Download log files	Downloads the system log files.
MAC	The MAC address for the node. The valid format is six groups of two hexadecimal digits, separated by hyphens (e.g. 01-23-45-67-89-ab).								
IPv4	The Internet Protocol version 4 address for the node. The valid format is: nnn.nnn.nnn.nnn.								
Network speed	Displays the current speed of the network.								
Download log files	Downloads the system log files.								
VNC	<p>Toggle buttons to enable/disable VNC access to the node. The default setting is disabled. A node has to be assigned to a controller to enable this feature. To change the default setting:</p> <ol style="list-style-type: none"> 1. Select the node to display the Node Profile page. 2. Click VNC On to enable access. <div data-bbox="500 1245 1315 1640" data-label="Image"> </div> <p>Once enabled, access to the node times out after 120 minutes. If within the 120 minutes and you need more time accessing the node, select VNC On again.</p>								
Currently encoding sources	<p>Displays the sources the node is currently encoding. This field is not displayed if the node is not currently encoding any sources.</p>								
Currently outputting to wall(s)	<p>Displays the walls that the node is currently decoding on. This field is not displayed if the node is not decoding to a wall.</p>								

Metrics Utilization Decoding Encoding Notes

NODE NOTES

 **Current Notes**

Add notes...

 **Node / System Support**

For problems with any node on the Phoenix Network, contact:

Joe Integrator
Work: (602) 943-5700
Work: (602) 943-5701
Work Email: jintegrator@vistasystems.net

How to Add a Node

A node is added to the network of nodes by physically connecting the node to the network. When the node is powered on, it is automatically detected by the Phoenix system software.

1. To assign the node to a controller, point to the node ID/Node Name in the Nodes List and click.

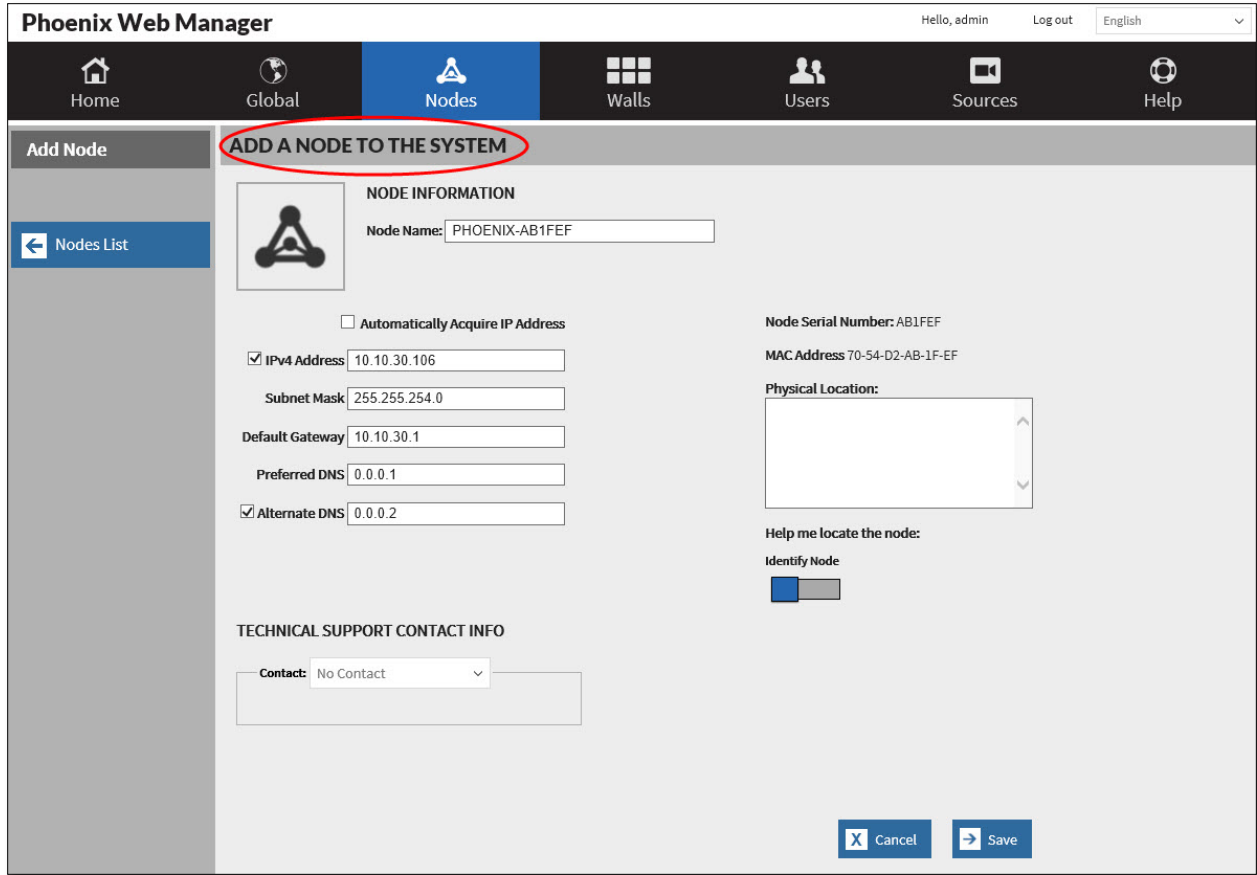

2. View the details for the node and make any desired changes.
3. Click **Save**.

How to Download the Details for the Nodes

1. To download the details for all nodes, click **Download Node Details**.

The screenshot shows the Phoenix Web Manager interface. At the top, there is a navigation bar with icons for Home, Global, Nodes (selected), Walls, Users, Sources, and Help. Below the navigation bar is a sidebar with a 'Nodes List' section containing categories like All Nodes(29), Controllers(1), Decoders(24), Encoders(24), Transcoders(24), Un-assigned(2), and Alerts(0). The main content area displays a table titled 'NODES' with columns for Node ID - Node Name, IP Address, Decoding, Encoding, Transcoding, and Outputs. A 'Download Node Details' link is visible in the top right corner of the table area.

Node ID - Node Name	IP Address	Decoding	Encoding	Transcoding	Outputs
00008D - PHOENIX 101	10.10.100.101	60%	0%	0%	1920 x 1080 @ 59...
03FF13 - PHOENIX 106	10.10.100.106	60%	0%	0%	1920 x 1080 @ 59...
0000ED - PHOENIX 102	10.10.100.102	60%	0%	0%	1920 x 1080 @ 59...
040288 - PHOENIX 120	10.10.100.120	60%	20%	0%	1920 x 1080 @ 59...
0000DA - PHOENIX 104	10.10.100.104	60%	0%	0%	1920 x 1080 @ 59...
0402B8 - PHOENIX 121	10.10.100.121	60%	20%	0%	1920 x 1080 @ 59...
0000DB - PHOENIX 118	10.10.100.118	60%	10%	0%	1920 x 1080 @ 59...
0000DE - PHOENIX 108	10.10.100.108	60%	0%	0%	1920 x 1080 @ 59...
0000E3 - PHOENIX 116	10.10.100.116	60%	0%	0%	1920 x 1080 @ 59...
040246 - PHOENIX 103	10.10.100.103	60%	0%	0%	1920 x 1080 @ 59...
040299 - PHOENIX 119	10.10.100.119	60%	20%	0%	1920 x 1080 @ 59...
0000DD - PHOENIX 112	10.10.100.112	60%	0%	0%	1920 x 1080 @ 59...
00008A - PHOENIX 111	10.10.100.111	60%	10%	0%	1920 x 1080 @ 59...
03FF0A - PHOENIX 107	10.10.100.107	60%	0%	0%	1920 x 1080 @ 59...

2. Click Save to save the file.

How to Edit a Node



If you have the Controller Redundancy option enabled, disable it before editing a controller. Editing a controller’s profile can cause a failover when the Controller Redundancy option is enabled.

Remember to re-enable it when you finish editing the controller.

To edit a note:

1. Click the node in the Nodes List.
2. Click **Edit** in the page navigation pane.

Node Name	The Node name is user-defined and can contain up to 20 characters (alphanumeric and special characters). The default node name is the serial number.
Automatically Acquire IP Address	Select the check box to enable the Web Manager to obtain the IP address automatically using DHCP. If you do not select this check box, you have to provide the IPv4 address. <div style="display: flex; align-items: center;"> <div style="font-size: 2em; margin-right: 10px;">i</div> <p>To avoid changes to the IP addresses, use static IP addresses.</p> </div>
IPv4	The Internet Protocol version 4 address for the node. The valid format is: nnn.nnn.nnn.nnn.
Subnet Mask	The subnet mask for the network address. This is an optional field.
Default Gateway	The node on the network that the network software uses when an IP address does not match any other routes in the routing table. This is an optional field.
Preferred DNS	The preferred server for resolving domain names. This must be set to use DNS names for RTSP sources.
Alternate DNS	The alternate server for resolving domain names.
Physical Location	A user-defined description to identify the physical location of the node.

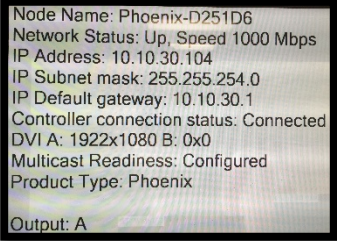
<p>Identify Node</p>	<p>Used to turn on and off the LED on the front of the node and display the node details on the wall output to help identify its location and status. When turned on, the LED blinks and the node details are displayed on the wall including:</p> <ul style="list-style-type: none"> • Node Name • Network Status • IP Address • IP Subnet mask • IP Default gateway • Controller connection status • DVI Status • Multicast Readiness • Product type • Display Output  <p>i The <i>Multicast Readiness: Configured</i> indicator is accurate if the IGMPV2 Snooping and Querier configuration are local to the switch. If the querier service is supplied by an external router, use Wireshark or Netmon to verify these services are present.</p>
<p>Technical Support Contact Info</p>	<p>Select a contact from the list to specify the support contact. This list is populated from the list of users with the role of admin.</p>
<p>Power Options</p>	<p>Used to shutdown (power off) the node or restart (power off and power on) the node. Select the desired option from the list and click the arrow icon.</p>

How to Un-assign a Node

To un-assign a node from a controller, click **Un-Assign**. When the node is un-assigned, the un-assigned (🔌) icon is displayed next to the node ID in the node list and the controller no longer manages it.

If the node was used on a display wall, it will be removed.

To reassign a node to a controller, edit the node profile.

When new nodes are connected to the LAN, the controller automatically detects them and serves as the controller for the node.

How to Stop Decoding on a Node

If there is an issue with a node that is decoding or you want to move the node to a different wall, click **Stop Decoding** to stop decoding on the node. When the decoding is stopped, you can assign the node to a different wall. When the node is re-assigned to a wall, the node will start decoding.

Manage Walls

To manage walls, click **Manage Walls** on the Home page or click **Walls** in the main navigation area. The list of current walls and any associated subwalls is displayed.



The term *wall* in this documentation refers to both walls and subwalls unless otherwise noted.

Name	Description	Outputs	Manager	Notes
small wall 2	small wall 2 Description	1 (1x1)	Tom Thumb	small wall 2 Notes
Big Wall 2 by 2	Big Wall 2 by 2 Description	4 (2x2)	Tom Thumb	Big Wall 2 by 2 Notes

Copyright © Vista Systems 2013

From this page you can view the profile for an existing wall, display a list of walls and subwalls, add a wall, edit a wall, and generate test patterns.

How to View a Wall Profile

Click the wall in the list of walls to display the wall profile.

The wall profile displays:

Graphic	Graphical representation of the nodes associated with the wall including the node ID, node name, and output.										
Mapped outputs	Number of outputs that are physically connected to an output port and configured on the wall. See the details below the Phoenix Nodes table.										
Unmapped outputs	Number of outputs that are physically connected to an output port but have not been assigned to a wall. See the details below the graphic.										
Nodes	Number of Phoenix nodes configured for the wall (also graphically displayed). See the details below the graphic.										
Resolution	Resolution of the wall (width and height in pixels). <div style="display: flex; align-items: center;"> <div style="border: 1px solid gray; border-radius: 50%; width: 30px; height: 30px; display: flex; align-items: center; justify-content: center; margin-right: 10px;">i</div> <p>All displays for one wall have to have the same resolution.</p> </div>										
Refresh Rate	Refresh rate for the wall (Hz).										
Show Wall Mapping	Used to identify the output on a wall by displaying the outputs (A or B).										
Wall Created	Date and time the wall was created.										
Reboot Wall	Restarts all nodes that output to the wall.										
Monitors On	Turns on all monitors associated with the wall.										
Monitors Off	Turns off all monitors associated with the wall.										
Phoenix Nodes	The details for the nodes that are configured for the wall. <table border="1" style="width: 100%; border-collapse: collapse;"> <tr> <td style="width: 20%;">Node ID</td> <td>The node ID for each node connected to the wall. The node ID is assigned by manufacturing (format: <i>serial number</i>).</td> </tr> <tr> <td>Node Name</td> <td>The name of each node connected to the wall.</td> </tr> <tr> <td>Output A</td> <td>List of outputs connected to the Output A connector for all of the nodes connected to the wall.</td> </tr> <tr> <td>Output B</td> <td>List of outputs connected to the Output B connector for all of the nodes connected to the wall.</td> </tr> <tr> <td>Identify Node</td> <td>Used to identify the Phoenix node by blinking the LED on the front of the node and displaying node details on the output.</td> </tr> </table>	Node ID	The node ID for each node connected to the wall. The node ID is assigned by manufacturing (format: <i>serial number</i>).	Node Name	The name of each node connected to the wall.	Output A	List of outputs connected to the Output A connector for all of the nodes connected to the wall.	Output B	List of outputs connected to the Output B connector for all of the nodes connected to the wall.	Identify Node	Used to identify the Phoenix node by blinking the LED on the front of the node and displaying node details on the output.
Node ID	The node ID for each node connected to the wall. The node ID is assigned by manufacturing (format: <i>serial number</i>).										
Node Name	The name of each node connected to the wall.										
Output A	List of outputs connected to the Output A connector for all of the nodes connected to the wall.										
Output B	List of outputs connected to the Output B connector for all of the nodes connected to the wall.										
Identify Node	Used to identify the Phoenix node by blinking the LED on the front of the node and displaying node details on the output.										

Last Updated	Date and time the wall was edited and the name of the user who made the change.
Wall Manager	The name of the user who created the wall.

How to Add a Wall

When you add a wall to the Phoenix system you define the format of the wall.

 You can configure up to 128 outputs for a wall.

1. Click **Add a Wall**.
2. Configure the details using the information in the following table.

 There are two pages for this task.

3. Map your outputs for the wall by dragging and dropping outputs from the list of Phoenix nodes to the desired location on the wall. You must select nodes that have the displays for the wall connected to the output A or B connectors on the nodes.

 If you enable Frame Synchronization, you must assign a node as the Master Sync and another node as the Last Sync.

4. Click **Save Wall Layout** to save the wall.

Phoenix Web Manager
Hello, admin Log out English

Home
Global
Nodes
Walls
Users
Sources
Help

Add Wall

← Walls List

ADD A WALL TO YOUR SYSTEM

Build Your Configuration - Step 1 (of 2)

Build a new wall for your Phoenix system. The information you enter (below) should configure a wall preview which matches your output array. Once you have built a successful wall preview, continue on to map your Phoenix nodes to your outputs (on the next page).

Basic Information

Wall Name

Output Array
 Wide x High

Output Spacing
 Bezel Compensation (+) Overlap Screens (-) None

Horizontal

Vertical

x Pixels

Directory Groups

DefaultWallGroups x

Output Format
 Format: Factory VESA

Rotation

NEW WALL TEMPLATE

This Wall preview should represent the information you entered above and match your wall's output configuration. If the template looks correct, click the Continue button and go to the next screen to map your Outputs to your Phoenix Nodes.

1	2	3	4
5	6	7	8

Continue

Output Format

Format: Factory VESA

Horizontal

x

Vertical

Pixels

Refresh Rate

Hz

Use reduced blanking

Rotation

Phoenix System Reference Manual
 020-101183-16 Rev. 1 (05-2019)

Copyright© 2019 Christie Digital Systems USA Inc. All rights reserved.

93

Phoenix Web Manager
Hello, admin Log out English

Home
Global
Nodes
Walls
Users
Sources
Help

Edit Wall

← Walls List

← Back

✕ Delete Wall

← Wall Profile

EDIT WALL PHOENIX 282

Map Your Outputs - Step 2 (of 2)

Map your Phoenix Nodes to your wall outputs. Simply drag and drop an available output from the nodes list onto an open wall output. When you are satisfied with the configuration of your wall outputs, be sure to save your wall layout (below). If you need to make minor wall adjustments, you will be prompted to apply test patterns (after your save).

WALL OUTPUTS

D251D6
A

E20C4B
A

D251D6
B

E20C4B
B

Enable Frame Synchronization [Clear my output assignments](#)

BackChannel

PHOENIX NODES

Node ID	Node Name	Output 1	Output 2	Identify Node
D251D6	PHOENIX-PEORIA	1	2	<input type="checkbox"/>
AB1FEF	PHOENIX-AB1FEF	AB1FEF A	AB1FEF B	<input type="checkbox"/>
E20C4B	PHOENIX-GLENDALE	3	4	<input type="checkbox"/>
S2183D	PHOENIX-S2183D	S2183D A	S2183D B	<input type="checkbox"/>

* Phoenix EP

✕ Cancel
→ Save Wall Layout

Frame Synchronization Configuration

Master Sync
Select the node you want to use as the start of the frame synchronization chain.

PHOENIX-GLENDALE

Last Sync
Select the last node at the end of the frame synchronization chain. It must be immediately before the master in the chain.

PHOENIX-PEORIA

→ Finish

Table 14 – Wall Fields







Field	Description	
Basic Information	Wall Name	User-defined name for the wall, maximum of 20 characters. This is a required field and will help you identify the wall in the list of walls.
	Directory Groups	Used to select the Directory Groups that can access this wall. Up to 10 groups can be added to a wall. To remove a group from a wall, select  next to the name.
Output Array	Describes the physical arrangement of the displays for the wall (e.g., four displays, two wide and two high, also referred to a 2 x 2).	
Output Format	<p>The output formats are Factory or VESA. The preferred method is Factory. VESA is used for equipment that requires a resolution that is not supported as a factory format or if more control over the output timing is needed.</p> <p>If Factory is selected, you need to specify the resolution for the display, the rotation (off, 90, 180, or 270), and enable or disable synchronization.</p> <p>If VESA is selected, you need to specify the display size in pixels, the refresh rate (Hz), rotation (off, 90, 180, 270) and enable or disable reduced blanking. Reduced blanking is used to reduce horizontal and vertical blanking if the receiving equipment can tolerate it. It will reduce the clock frequency on the cable, potentially allowing longer cable lengths or lower quality cables to still function properly.</p>	
Output Spacing	Settings for output spacing include:	
	Bezel Compensation (+)	Select to compensate for the width of the bezel around the edges of the display by adding space between the two outputs. If selected, set the horizontal and/or vertical compensation. Adjust the horizontal spacing for outputs that are side by side (e.g., 2 wide x 1 high). Adjust the vertical spacing for outputs that are stacked vertically (e.g., 1 wide x 2 high).
	Overlap Screens (-)	Select to compensate for blending the overlapping edges of neighboring images on a wall. If selected, set the horizontal and/or vertical compensation. Adjust the horizontal spacing for outputs that are side by side (e.g.: 2 wide x 1 high). Adjust the vertical spacing for outputs that are stacked vertically (e.g.: 1 wide x 2 high).
	None	Select to not use output spacing.
New Wall Template	A graphical representation of the wall you are adding.	
Wall Outputs	<p>Assigns outputs to the displays on the wall. The list is populated with all the nodes assigned to the controller that are not currently decoding for a wall.</p> <p> When editing a wall, the list will include the nodes that have been assigned to the wall you are editing.</p> <p>Drag and drop the output to the desired location. The node is displayed on the wall and the list of nodes is updated with the location of the node on the wall.</p>	

Table 14 – Wall Fields

Field	Description						
Enable Frame Synchronization	<p>Frame Synchronization is used to interconnect all the nodes in a wall so all the content being displayed across a node boundary would remain synchronized. When using the BackChannel option for frame synchronization, the Sync connectors on the back of every node must be connected (refer to How to Synchronize the Display Wall, page 35). See Figure 10 for an example. Additionally, you have to identify a node as the master sync and the node that is the last link in the chain (Last Sync) in the Sync port wiring scheme. A pop-up is displayed prompting for this information. The node assigned as the Last Sync must have its output connector connected to the master’s input connector.</p> <table border="1"> <tr> <td>None</td> <td>Frame synchronization not enabled. This setting may also be used to troubleshoot an issue.</td> </tr> <tr> <td>BackChannel</td> <td> <p>Provides the most accurate synchronization among video outputs and the lowest possible latency. Normally used when timing differences of less than one frame are noticeable, such as for displays with extremely minimal/nonexistent divisions between them that are showing fast-moving content.</p> <p> The BackChannel synchronization is supported by wiring across Phoenix nodes. It provides superior screen-to-screen performance versus Network synchronization. When using Network synchronization, one frame differences may be visible for some content.</p> <p>BackChannel synchronization operates with lower latency than Network synchronization.</p> </td> </tr> <tr> <td>Network</td> <td> <p>Provides the maximum video smoothness as well as accurate audio/video sync. Other advantages are that wall size is less of a limitation, and that setup is simpler than wiring and configuring the BackChannel.</p> <p>In most cases, it is advisable to try Network sync first before using BackChannel sync.</p> </td> </tr> </table>	None	Frame synchronization not enabled. This setting may also be used to troubleshoot an issue.	BackChannel	<p>Provides the most accurate synchronization among video outputs and the lowest possible latency. Normally used when timing differences of less than one frame are noticeable, such as for displays with extremely minimal/nonexistent divisions between them that are showing fast-moving content.</p> <p> The BackChannel synchronization is supported by wiring across Phoenix nodes. It provides superior screen-to-screen performance versus Network synchronization. When using Network synchronization, one frame differences may be visible for some content.</p> <p>BackChannel synchronization operates with lower latency than Network synchronization.</p>	Network	<p>Provides the maximum video smoothness as well as accurate audio/video sync. Other advantages are that wall size is less of a limitation, and that setup is simpler than wiring and configuring the BackChannel.</p> <p>In most cases, it is advisable to try Network sync first before using BackChannel sync.</p>
None	Frame synchronization not enabled. This setting may also be used to troubleshoot an issue.						
BackChannel	<p>Provides the most accurate synchronization among video outputs and the lowest possible latency. Normally used when timing differences of less than one frame are noticeable, such as for displays with extremely minimal/nonexistent divisions between them that are showing fast-moving content.</p> <p> The BackChannel synchronization is supported by wiring across Phoenix nodes. It provides superior screen-to-screen performance versus Network synchronization. When using Network synchronization, one frame differences may be visible for some content.</p> <p>BackChannel synchronization operates with lower latency than Network synchronization.</p>						
Network	<p>Provides the maximum video smoothness as well as accurate audio/video sync. Other advantages are that wall size is less of a limitation, and that setup is simpler than wiring and configuring the BackChannel.</p> <p>In most cases, it is advisable to try Network sync first before using BackChannel sync.</p>						
Phoenix Nodes	Provides the details for the nodes available on the network.						
Phoenix Output Navigator	<p>This tool is only displayed if you are adding a wall that is larger than a 7 x 10 output array. Click inside the colored box and drag it to view a different area of the wall in the Wall Outputs display area.</p> <p> Additionally, you can use the Next Output arrows to change the outputs in the Wall Outputs display.</p>						
Zoom	This field is only available when the Phoenix Output Navigator is active. Select the zoom level to enlarge or decrease the size of the outputs in the Wall Outputs display.						

How to Implement Subwalls

Subwalls are portions of walls that are created and secured for specific users. Subwalls cannot overlap; one output can only be part of one subwall.

To access a subwall, a user must be a member of the associated Wall Group. Users can manage subwalls using the same tools used to manage walls. Users who manage subwalls can also be assigned access to specific groups of sources using Source Groups.

To implement sub walls:

1. Create an implementation plan including the walls that will be used to create subwalls and the users that will access these subwalls.



The wall used to create subwalls must be physically connected to the outputs before creating subwalls.

2. Use the Directory Services settings on the Global Page to create wall groups for the subwalls using logical names.

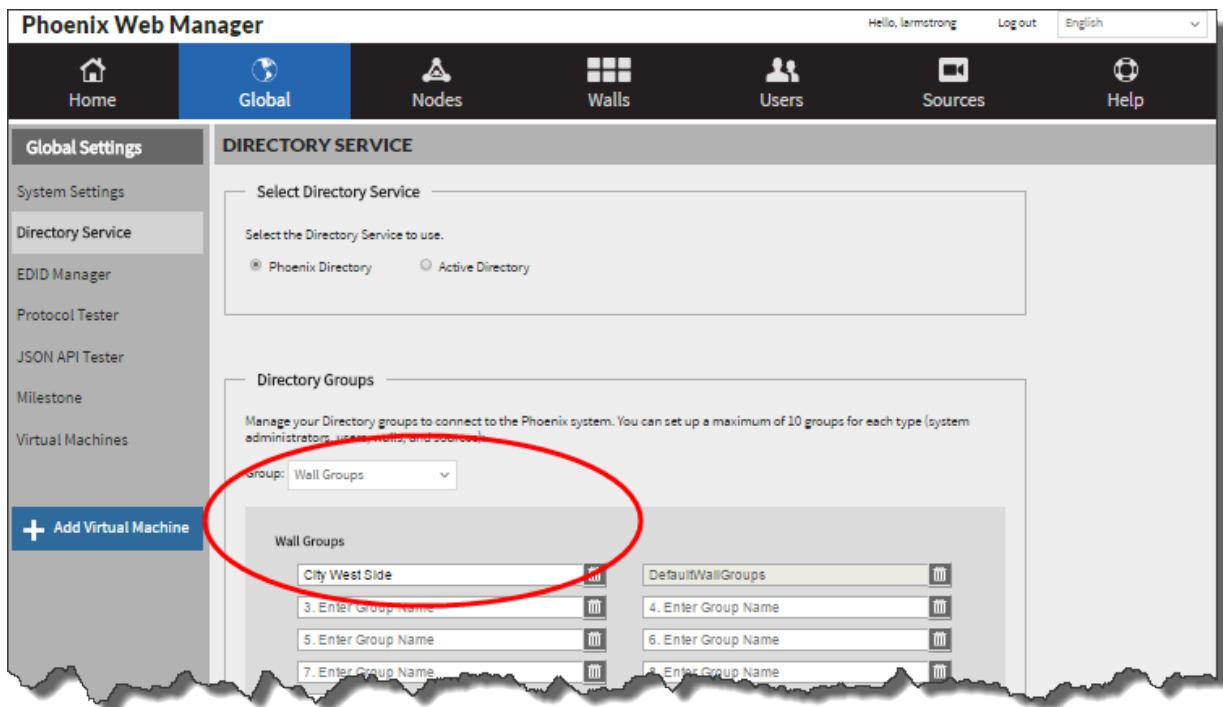

3. Assign walls to the subwall groups.

Phoenix Web Manager Hello, Iamstrong Logout English

Home Global Nodes **Walls** Users Sources Help

Edit Wall

Walls List Delete Wall Wall Profile

EDIT WALL 2X2 WALL

Build Your Configuration - Step 1 (of 2)

Build a new wall for your Phoenix system. The information you enter (below) should configure a wall preview which matches your output array. Once you have built a successful wall preview, continue on to map your Phoenix nodes to your outputs (on the next page).

Basic Information

Wall Name: 2x2 wall

Directory Groups: City West Side

Output Array

2 Wide x 2 High

Output Spacing

Horizontal: 0 x Vertical: 0 Pixels

Output Format

Format: Factory VESA

Horizontal: 1680 x Vertical: 1050 Pixels

Refresh Rate: 59.94 Hz Use reduced blanking

Rotation: Off

NEW WALL TEMPLATE

This Wall preview should represent the information you entered above and match your wall's output configuration. If the template looks correct, click the Continue button and go to the next screen to map your Outputs to your Phoenix Nodes.

1 2
3 4

Cancel Continue

4. Assign user groups to the subwall groups.

Phoenix Web Manager Hello, service Logout English

Home Global Nodes Walls **Users** Sources Help

Add User

Users List

CREATE A NEW USER

Employee Information

First Name: Steven

Last Name: King

Login: sking

Password:

Re-Type Password:

Phone Numbers: Work 623 792-7900

Email Addresses: Work sking@christiedigital.com

Directory Groups: City West Side

Add notes here...

Save

User Created

User Activity

Last Login:

Last Update

5. Use the Web Manager to create the subwall. See [How to Create a Subwall](#).

How to Create a Subwall

Create one or more subwalls as follows:

1. Click the wall name on the Walls List to display the wall profile for the wall that will be used to create the new subwall.
2. Click **Subwalls** in the page navigation pane.

The screenshot shows the Phoenix Web Manager interface. The top navigation bar includes Home, Global, Nodes, Walls (selected), Users, Sources, and Help. The left sidebar contains Wall Profile, Walls List, Add Wall, Edit Wall, Test Patterns, and Subwalls (circled in red). The main content area displays the '2X2 WALL' profile with a 2x2 grid of outputs: PHOENIX-61E932 A, PHOENIX-61E925 A, PHOENIX-61E932 B, and PHOENIX-61E925 B. A summary panel on the right shows Mapped Outputs: 6, Unmapped Outputs: -2, Nodes: 2, Resolution: 1680 x 1050, and Refresh Rate: 59.94 Hz. Below the grid are buttons for Reboot Wall, Monitors On, and Monitors Off. A table titled 'PHOENIX® NODES' is shown at the bottom.

Node ID	Node Name	Output A	Output B	Identify Node
61E932	PHOENIX-61E932	61E932 A	61E932 B	<input type="checkbox"/>
61E925	PHOENIX-61E925	61E925 A	61E925 B	<input type="checkbox"/>



All the outputs for the wall can be used to create subwalls. The maximum number of subwalls that can be created is equal to the number of outputs associated with the wall.

3. Use the mouse (click and drag) to create a window over the desired area of the wall to create the subwall. The window will snap to the nearest wall border.
4. Use the handles to adjust the size of the subwall.

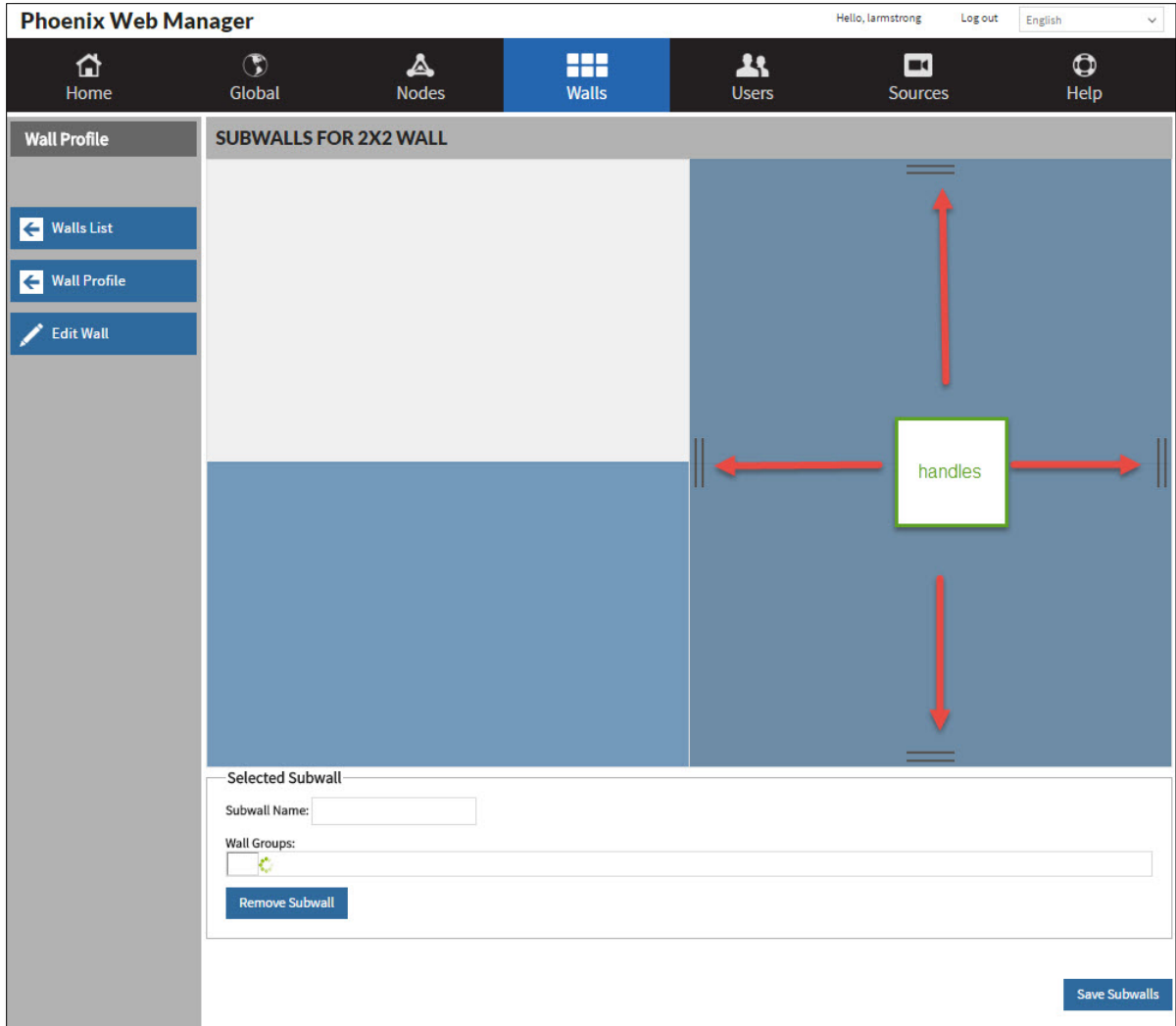

5. In the **Subwall Name** field, type a name for each subwall.
6. Select **Wall Groups** for each subwall.

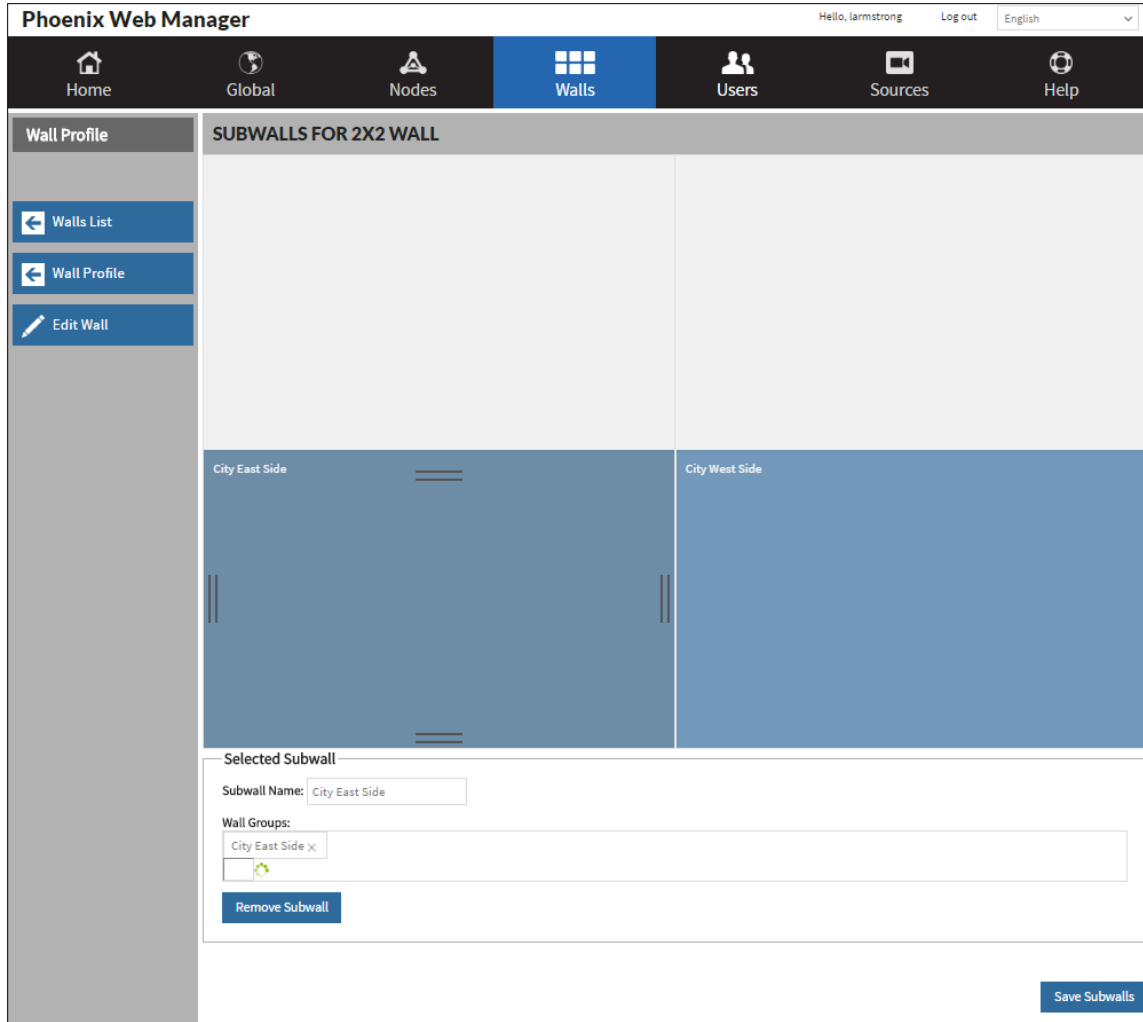

7. Click **Save Subwalls**. In the wall list, the subwall will be displayed under the wall that it was created from.

Name	Resolution	Outputs	Manager
1x2 wall	1024 x 768	2 (1x2)	
2x2 wall	1680 x 1050	4 (2x2)	
City East Side	1680 x 1050	4(2x2)	
City West Side	1680 x 1050	4(2x2)	

8. Add sources to the subwall. Refer to [How to Add a Source](#), page 54.

Only sources completely located in the subwall boundaries will be visible.

If you attempt to move a source out of the subwall boundaries, it will snap back to its original position.



Background colors and background images will not be displayed on subwalls. They can only be assigned from the main wall.

Sources created using the main wall that span into subwalls will not display for the active users of the Desktop Client. The users must log off and log back in to see the newly-added sources.

How to Edit a Wall

To edit a wall:

1. Click the wall on the Walls List.
2. Click **Edit Wall** in the page navigation pane.
3. Make the desired changes referring to [Table 14](#) (page 95) for additional information.
4. Click **Save Wall Layout**. When selected, your changes are saved and the wall is rebooted.

Phoenix Web Manager
Hello, admin
Log out
English

Home
Global
Nodes
Walls
Users
Sources
Help

Edit Wall

← Walls List

✕ Delete Wall

← Wall Profile

EDIT WALL PHOENIX 282

Build Your Configuration - Step 1 (of 2)

Build a new wall for your Phoenix system. The information you enter (below) should configure a wall preview which matches your output array. Once you have built a successful wall preview, continue on to map your Phoenix nodes to your outputs (on the next page).

Basic Information

Wall Name

Output Array
 Wide x High

Output Spacing
 Bezel Compensation (+) Overlap Screens (-) None

Horizontal

Vertical

x

Vertical

Pixels

Active Directory Groups

✕

Output Format
 Format: Factory VESA

Rotation

NEW WALL TEMPLATE

This Wall preview should represent the information you entered above and match your wall's output configuration. If the template looks correct, click the Continue button and go to the next screen to map your Outputs to your Phoenix Nodes.

1

2

3

4

✕ Cancel

→ Continue

Phoenix Web Manager Hello, admin Log out English

Home Global Nodes **Walls** Users Sources Help

Edit Wall EDIT WALL PHOENIX 282

Map Your Outputs - Step 2 (of 2)
 Map your Phoenix Nodes to your wall outputs. Simply drag and drop an available output from the nodes list onto an open wall output. When you are satisfied with the configuration of your wall outputs, be sure to save your wall layout (below). If you need to make minor wall adjustments, you will be prompted to apply test patterns (after your save).

WALL OUTPUTS

D251D6 A	D251D6 B
E20C4B A	E20C4B B

Enable Frame Synchronization BackChannel [Clear my output assignments](#)

PHOENIX NODES

Node ID	Node Name	Output 1	Output 2	Identify Node
D251D6	PHOENIX-PEORIA	1	2	<input type="checkbox"/>
E20C4B	PHOENIX-GLENDALE	3	4	<input type="checkbox"/>
AB1FEF	PHOENIX-AB1FEF	AB1FEF A	AB1FEF B	<input type="checkbox"/>

* Phoenix EP

Cancel Save Wall Layout

How to Bulk Edit Walls

1. System [How to Apply Test Patterns](#)

The **Test Patterns** option on the Wall Profile page enables you to apply test patterns to a wall. The patterns can be a solid color or a graphic with or without overlays (e.g., center x or a grid).

To apply test patterns to a wall:

1. From the Walls List, click on a wall to open its profile.
2. Click **Test Patterns**.

3. Select the desired test pattern options.
4. Click **Apply Test Pattern** to update the wall.
5. To remove the test pattern, click **Remove Test Pattern**.

Manage Users

To manage users, click **Manage Users** on the Home page or click **Users** in the main navigation area.



This page adds users to both the Web Manager interface and the Desktop Client interface.

Phoenix Web Manager Hello, admin Log Out English

Home Global Nodes Walls **Users** Sources Help

User List **USERS**

+ Add User

User Name	Roles	Last Login	Notes
White	User		jkdlfsa;mdnfna;neinral;dfm dfdfs...
jttester	Administrator	3/1/2013 9:38 AM	
adesigner	Administrator	2/25/2013 1:34 PM	
Mbowers	Administrator	2/18/2013 11:09 AM	
twriter	Administrator		
Case	Administrator	3/1/2013 9:18 AM	

Copyright © Vista Systems 2013

If the Active Directory feature is enabled, a link to Update Users from Active Directory is available and all the configured user groups are listed. When a group is selected, all the members in the group are listed.

Phoenix Web Manager Hello, rt_admin Log out English

Home Global Nodes Walls **Users** Sources Help

User List **USERS**

Update Users from Active Directory

User Name	Roles	Last Login
rt_user1_s1w3	User	Mon Jul 28 2014 6:51:00 AM
rt_user2_s2w1	User	Mon Jul 28 2014 6:51:00 AM
rt_user3_s2w1	User	Mon Jul 28 2014 6:51:00 AM
rt_user4_s3w1	User	Mon Jul 28 2014 6:51:00 AM
rt_user5_s1s4w1w2	User	Mon Jul 28 2014 6:51:00 AM
rt_admin_noswgroups	Administrator	Mon Jul 28 2014 6:51:00 AM
rt_admin_s1s4w1w2	Administrator	Mon Jul 28 2014 6:51:00 AM
rt_admin	Administrator	Mon Jul 28 2014 9:50:00 AM
rt_admin2	Administrator	Mon Jul 28 2014 6:51:00 AM
rt_admin3	Administrator	Mon Jul 28 2014 6:51:00 AM
rt_admin4	Administrator	Mon Jul 28 2014 6:51:00 AM
specialchar	Administrator	Mon Jul 28 2014 6:51:00 AM
jmaxpass	Administrator	Mon Jul 28 2014 6:51:00 AM
groupconflict	Administrator	Mon Jul 28 2014 7:05:00 AM



System Administrators must use this link to update the Phoenix system with any changes to users in the Active Directory database.

From this page you can view the profile for an existing user, display a list of existing user, add a user, and edit a user.

How to View a User Profile

Click a user name on the list of users to display the details for the user profile. From this page, you can view the profiles of the current users or you can add a user.

Login	Login name for the user.
Role	User or Administrator. Administrators have access to the Web Manager and the Desktop Client interface. Users have access to the Desktop Client interface only.
Contact Numbers	Up to two phone numbers.
Email addresses	Up to two email addresses.
User Created	Date and time the user was added.
User Activity	Time and date of the last login for the user.
Last Update	Time and date of the last update to the user profile and the user name of the person who did the update.
Note	Notes added for the user.

How to Add a User

1. From the User List page, click **Add User**; or if the Active Directory feature is enabled, select the **Update Users from Active Directory** to start an update.
2. Configure the details using the information in the following table.
3. Click **Save**.



To add security questions for password recovery, use the **Change Security Questions** link on the Login page. Refer to [How to Add or Change Security Questions](#), page 118.

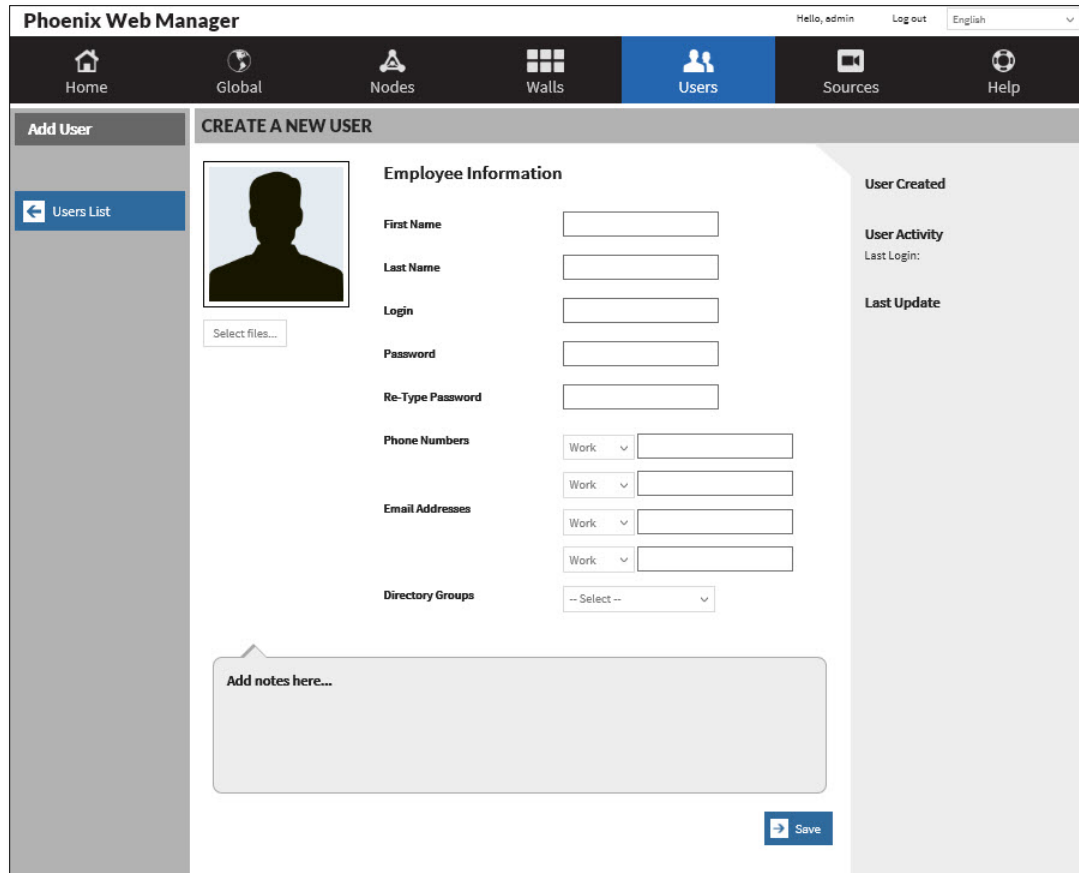

Select	Select a graphic file to add to the user profile.
First Name	Enter the first name of the user.
Last Name	Enter the last name of the user.
Login	Enter a login for the user (maximum of 20 alphanumeric characters).
Password	<p>Passwords cannot contain spaces and must contain eight or more characters, including at least three of the following:</p> <ul style="list-style-type: none"> • Uppercase letter • Lowercase letter • Number • Special character
Re-type Password	Retype the password.
Role	User or Administrator. Administrators have access to the Web Manager and the Desktop Client interface. Users have access to the Desktop Client interface only.
Phone Numbers	Enter the phone numbers to contact the user.
Email Addresses	Enter the email to contact the user.
Directory Groups	Used to select the Directory Groups for this user. A user can be added to 10 groups. To remove a user from a group, select  .
Notes	Add any user-defined notes for the user.

How to Edit a User Profile



If the Active Directory feature is enabled, you cannot edit users using the Web Manager. Make changes to users in Active Directory, and then use the *Update Users from Active Directory* button to update them in the Web Manager.

1. Click the user in the User List.
2. Click **Edit User** in the page navigation pane.
3. Make the desired changes. Refer to *How to Add a User (107)* for a description of the fields.
4. Click **Save**.

How to Change a Password

If your password expires or you forget it:

1. Click **Change/Forgot Password** on the login page.



2. Enter the User Name and click **Submit**.

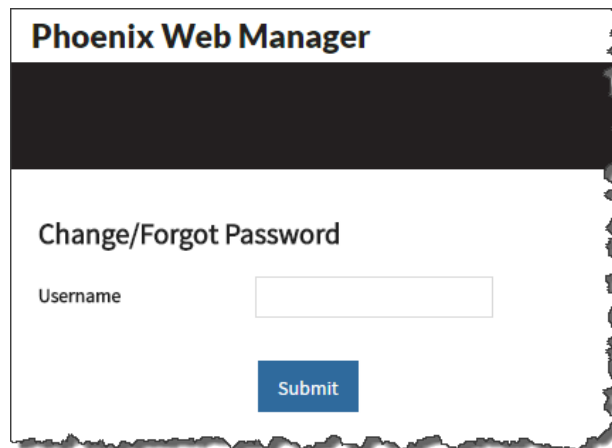

3. Answer the security questions.

The screenshot shows the 'Phoenix Web Manager' interface with the 'Change/Forgot Password' section. Below the title, it says 'Please answer your security questions:'. There are three text input fields with the following prompts: 'What was the name of your first pet (FIRST NAME only)?', 'What is the FIRST NAME of the best man/maid of honor at your wedding?', and 'What is your MATERNAL grandfather's FIRST NAME?'. A blue 'Submit' button is located at the bottom right of the form area.

4. Click **Submit**.
5. Type the new password (twice) and click **Save**.

The screenshot shows the 'Phoenix Web Manager' interface with the 'Change/Forgot Password' section. It features two text input fields labeled 'Password' and 'Confirm Password'. A blue 'Save' button is positioned below the second input field.

How to Unlock a User Account

If stringent security is active and a user attempts to log in three times with the wrong password, the user account will be locked. A system administrator must unlock the account.

The screenshot shows the 'Phoenix Web Manager' login interface. It includes a 'Language' dropdown menu set to 'English', 'Login' and 'Password' text input fields. A red-bordered message box displays 'Account locked'. A blue 'SIGN IN' button is located at the bottom of the form.

To unlock a user account:

1. Login as an administrator.
2. Click the user in the User List.
3. Click **Edit User** in the page navigation pane.
4. Click **Unlock**.
The Password field is cleared.

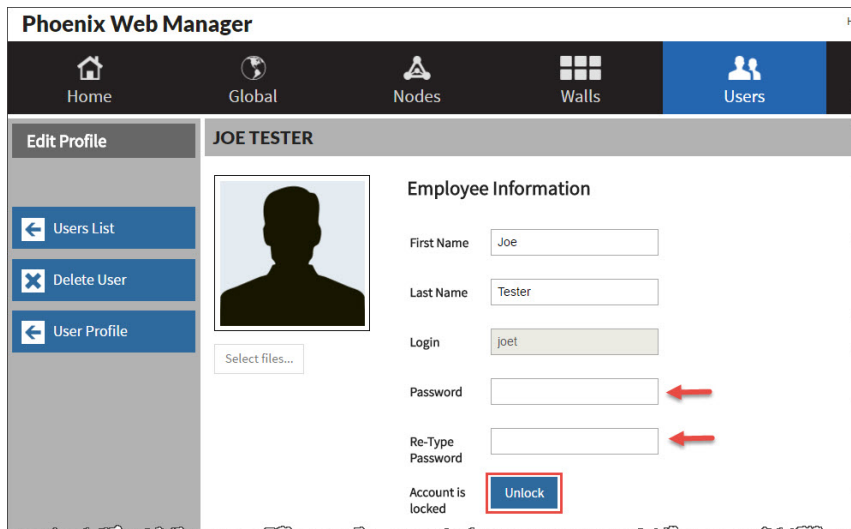

5. Enter a temporary password for the user.
6. Click **Save**.
7. Notify the user that the account is unlocked and provide the temporary password.

How to Force Users to Logout

If needed, administrators can force users to logout.

1. On the Users page, select one or more user names.
2. Click **Force Logoff**.

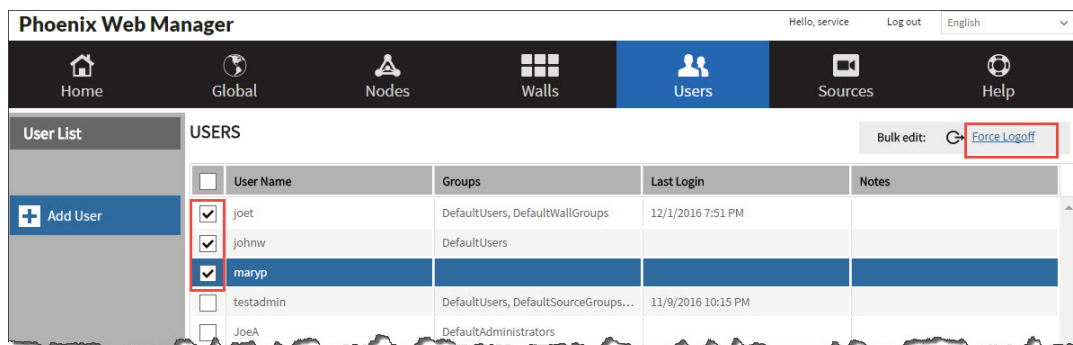

3. The selected users will be logged out and notified with a pop-up message:

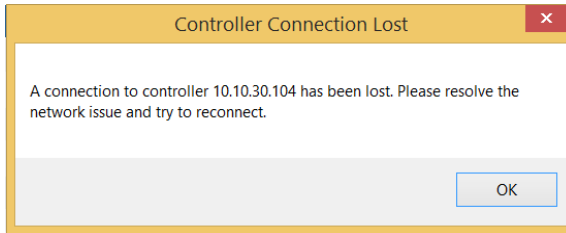

How to Change the Default Password

The system is shipped with the following default user account:

- User name: service
- Password: service

For security purposes, you are forced to change the password for the default user account.



Once you change the password for this account, it cannot be changed back to the default password (service).

To change the default password:

1. On the login page, use the following credentials and click **SIGN IN**:
 - User name: service
 - Password: service
2. When prompted, select and answer the security questions.
3. Type the new password in the **Password** field, confirm it by typing it again in the **Confirm Password** field, and then click **Save**.

You are automatically logged out.



Passwords cannot contain spaces and must contain eight or more characters, including at least three of the following:

- Uppercase letter
- Lowercase letter
- Number
- Special character

4. Login using the new password.

How to Delete a User



If the Active Directory feature is enabled, you cannot delete users using the Web Manager. Make changes to users in Active Directory, and then use the *Update Users from Active Directory* button to update them in the Web Manager.

To limit a user's access to the system, you can delete the user's profile.

To delete a user:

1. Click the user in the user list.
2. Click **Edit User**.
3. Click **Delete User**.
4. Click **OK** to confirm the deletion or **Cancel** to cancel the request.

Update Global System Settings

To update the global settings for the system, click **Update Global System Setting** on the Home page or click **Global** in the main navigation area.

Global settings include:

- System Settings
- Directory Service
- EDID Manager
- Protocol Tester
- JSON API Tester
- Virtual Machines
- Phoenix Quick Control

Manage System Settings

To manage system settings, click **System Settings** on the Global Settings page.



Most of the options on this page require a system restart to change the settings. An alert will be displayed when a restart is necessary.

Use this page to:

- Update the software and firmware for the nodes.
- Set the time zone and time for the Phoenix controller and all associated nodes.
- Set the security type.
- Set the encoding defaults for video and audio.
- Set the default starting IP address used for multicast delivery.
- Set the API communication method.
- Optionally set all web connections to use SSL.
- Set the Maximum Transmission Unit (MTU) for Video and Audio Packets.
- Set the Time to Live (TTL) for Unicast and Multicast packets.
- Set an option to restore last display wall layout after a restart.
- Set an option for the style displayed on the outputs when the system is starting.
- Set the cursor size for the display wall for interaction mode.
- Set the time-out setting for a mouse on the display wall for interaction mode.
- Display a mouse on a KVM layer for interaction mode.
- Activate/deactivate the controller redundancy option.
- Backup the system.
- Restore the system from a restore point.
- Restart the system with the current configuration and reboot the display wall and all associated nodes.
- Restore the system to factory defaults.

System Settings

The following items are included in the System Settings:

Update System

Browse your computer to find a .pfw file to update the software and firmware for your Phoenix system:

⚠ **BEWARE:** This process requires multiple restarts of the system and may take several minutes to complete, while your system is offline. The process includes an initial reboot of the controller and continues with reboot(s) of the dependent nodes.

Select files...

Time

Select the time zone and set the time for the Phoenix System.

Current Time: 8:26:14

Set Time

08 : 25

Time Zone

US Mountain Standard Time

Save Time

⚠ **Caution:** Clicking Save Time will cause the controller and system to restart automatically.

Security Type

Select the appropriate Security Level.

Basic

Save Security Type

Encoding Defaults

Set your encoding defaults to include the following formats and parameters:

Video Bitrate 4000 Kbps

Audio Format AAC

Stop encoding/decoding when a source is no longer in use. (Be aware that this may slow down initial display of sources)

Save Encoding Defaults

Multicast Start Address

Define the default IP address used for multicast delivery:

IPv4 Address: 239.1.0.0

Save Address

API Connection

Select the appropriate communication mechanism for the API.

Network

Save API

Force SSL

Selecting the option will force all web connections to use SSL. API Connections do not use SSL.

Off

Save SSL

MTU (Max Transmission Unit)

Sets the Maximum Transmission Unit for Video and Audio Packets

1410

[Save MTU](#)

TTL (Time to Live)

Set the TTL for Unicast and Multicast packets.

Unicast

Multicast

[Save TTL](#)

Restore Last Layout

Restore last display wall layout on startup:

Yes No

[Save Last Layout](#)

Source Startup Style

The style that will be shown while a source is starting up.

Grey Bars Black

[Save Style](#)

Wall Cursor Size

Control the size of your cursor as it appears on the display wall:

Normal Large Extra Large

[Save Cursor Size](#)

Display Wall Mouse Timeout

Control the time-out settings for a mouse on the display wall:

Always leave mouse on Always leave mouse off Auto-delay mouse by:

Seconds

[Save Mouse Timeout](#)

Display Mouse vs. KVM Layers

Do you wish for the system to display your mouse on a KVM layer?

Yes No

[Save KVM](#)

Controller Redundancy

If your controller fails, do you want a new one automatically assigned?

Yes No

Redundant Controller Preference

Alert Timeout

[Clear Controller Swap alert \(shown on the wall\)](#)

[Save Redundancy Settings](#)

Backup System/Restore Points

Save your system configuration by creating a new restore point.

[Backup System...](#)

- or -

Browse your computer to find a different restore point and to overwrite your current system configuration:

⚠ BEWARE: This process will completely overwrite your current system configuration.

Restart System

Refresh your system if you have encountered any unexpected problems. A system restart will reboot the display wall and all associated nodes, and apply the last system save.

[Restart System](#)

Wipe System (Restore to factory defaults)

Restore your Phoenix system back to its original factory defaults. A system wipe removes all saved system information, including: sources, treatments, wall layouts, user profiles, thumbnails, etc.

Also remove walls

⚠ BEWARE: With the exception of the controller role assignment, this function will permanently erase ALL system data.
 [Wipe System](#)

Figure 24 – System Settings

Update the System

The Update System option updates your system with a new version of software and/or firmware. It should only be performed when you are notified of an update.



This process requires multiple restarts of the system.

A system update should not be performed when any changes are being made to the system. If there are users logged on, ask them to log out.

Software Versioning

The system software release numbering is in the form of three numeric fields (e.g., 2.1.19) separated by decimal points. The fields in order from left to right are: major, minor, and revision.

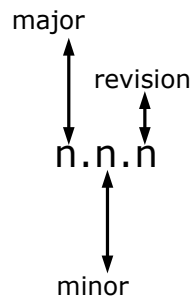

Figure 25 – Software Versioning Fields

Table 15 – Software Versioning

Field	Description
Major	Increases by one when new functionality is added.
Minor	Increases by one when enhancements to the functionality are added.

Revision	Incremented by one for every release including internal releases. This may result in gaps in the numbering for customer software releases.
----------	--

How to Update the System

What you need: A .pfw file with the desired version of the software and/or firmware.



You can send instant messages to users who are currently logged on.

To update the system:

1. From the Update System pane on Global Settings page, click **Select** to browse for the desired .pfw file.
2. Select the file.
3. When prompted, confirm the reboot. The system will be updated and restarted.

How to Change the Time Zone and Time

To change the default time zone and/or time for the controller and all associated nodes:

In the Time pane in System Settings on the Global Settings page:



Changing the time zone and/or time requires a system restart. This restart begins immediately after clicking **Save Time**.

1. Set the desired time.
2. Select the desired time zone.
3. Click **Save Time**. The system will automatically begin the restart process.

How to Set the Security Type

There are two levels of security; basic and stringent. Both levels require a user name and password. Passwords cannot contain spaces and must contain eight or more characters, including at least three of the following:

- Uppercase letter
- Lowercase letter
- Number
- Special character

Additionally, the stringent level requires selecting security questions, and administrator passwords expire after six months and user passwords expire after one year.

The following summarizes the differences in the two levels.

Complexity Requirements	Basic Mode	Stringent Mode
Security Certificate for accessing the Phoenix Web manager.		✓
Security questions.		✓
Passwords cannot contain spaces and must contain eight or more characters, including at least three of the following:	✓	✓

<ul style="list-style-type: none"> • Uppercase letter • Lowercase letter • Number • Special character 		
Expiration of administrator passwords in six months.		✓
Expiration of user passwords in 12 months.		✓
Desktop Client trust certification.	Optional	✓
Automated Web Manager Inactivity Timeout	✓	✓

To set the security type, in Security Type pane on the Global Settings page:



Changing the security type requires a system restart.

1. Select the desired security type.
2. Click **Save Security Type**.
3. When prompted, click **OK** to acknowledge the system has to be restarted the system.
4. In the Restart System section of the System Settings page, click **Restart System**.
5. When prompted, Click **OK** to start the restart or click **Cancel** to cancel the request.

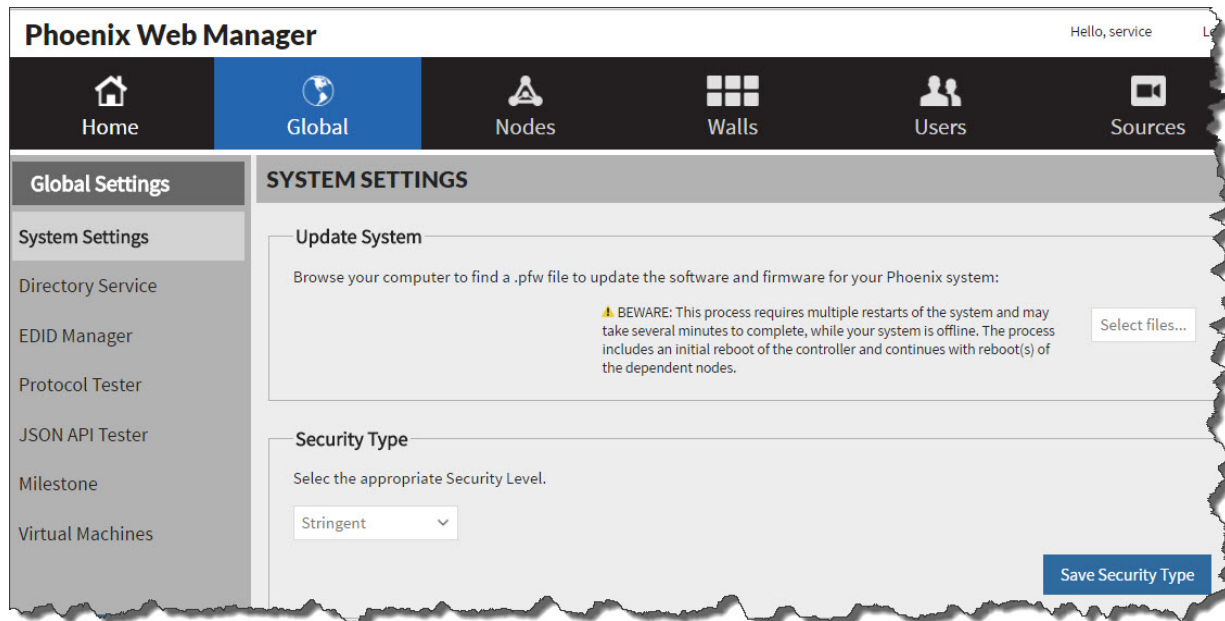

When Stringent is selected, you are prompted to answer security questions.

How to Add or Change Security Questions

1. To add or change your security questions or answers, click the **Change Security Questions** link on the Web Manager sign in page.

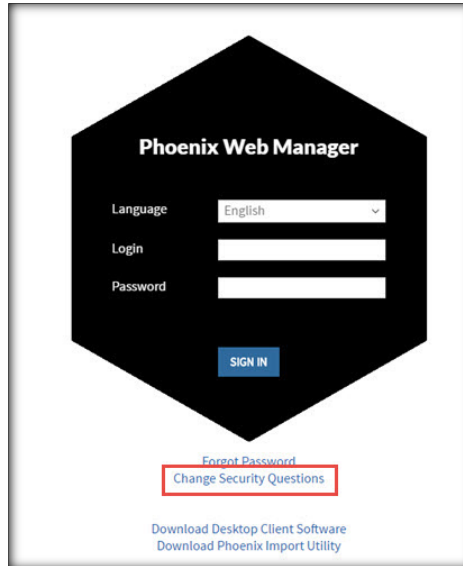

2. Select the desired question and enter your answers and click **Save**.

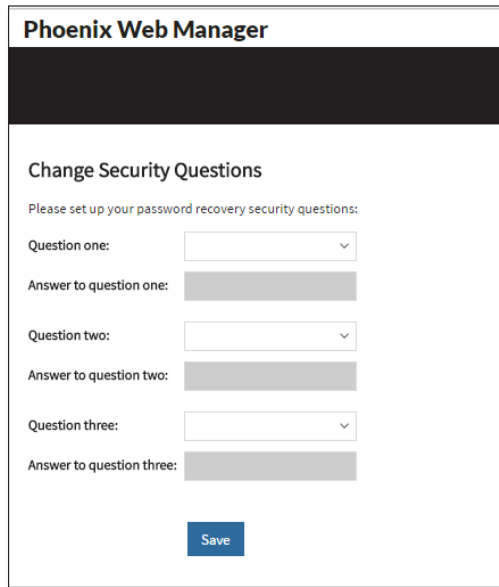

How to Set Encoding Defaults

The Encoding Default settings are used to set the default bitrate for video, the default format for audio, and to stop encoding/decoding a source when it is no longer in use.



When changes are made to the default settings, these changes are not applied to existing inputs until they are restarted. When the system is restarted, all nodes and walls are rebooted.

To set encoding defaults, in the Encoding Defaults pane on Global Settings page:

1. To set the encoding defaults for video, input the desired bitrate (Kbps).



Sources with higher bitrates have higher quality but also have larger file sizes.

2. To set the encoding defaults for audio, select the desired format (AAC, MPEG, or PCMU).
3. To stop encoding/decoding sources that are not in use, select the check box.



If selected, the stream will be deactivated when the source is deleted from the wall simulator. This is useful for networks containing a lot of cameras and when wall layouts are changed often. If this is not checked, the source will continue streaming to the system, even when it is not displayed on a wall. This can be useful if the same sources are recalled repeatedly on a wall.

4. Click **Save Encoding Defaults**.
5. When prompted, click **OK** to acknowledge the system has to be restarted the system.
6. In the Restart System section of the System Settings page, click **Restart System**.
7. When prompted, Click **OK** to start the restart or click **Cancel** to cancel the request.

How to Set the Starting Address for Multicasting

The starting address needs to change if other networked devices are using specific multicasting addresses. Each device in the network requires a unique address. This address does not need to be set unless there are conflicting devices on the same network.



The network switch must support multicasting.
The settings must be unique for multicasting.

The valid format for an IPv4 address is: nnn.nnn.nnn.nnn.

To set the address:

1. In the Multicast Start Address pane on the Global Settings page, type the starting address in the correct format.
2. Click **Save Address**.
3. When prompted, click **OK** to acknowledge the system has to be restarted the system.
4. In the Restart System section of the System Settings page, click **Restart System**.
5. When prompted, Click **OK** to start the restart or click **Cancel** to cancel the request.

How to Set the Communication Method for the API Connection

This option is used to set the communication method for APIs. Valid settings are:

Off	Disables API access to the system.
Network	Uses the network for APIs (default setting).
RS232	Uses the COM1 port for APIs. To communicate with a Phoenix system over a serial port link using the COM1 port on the controller, the RS232 client must be configured as follows:

	<table border="1"> <tr> <td>Baud Rate</td> <td>115200</td> </tr> <tr> <td>Parity</td> <td>None</td> </tr> <tr> <td>StopBits</td> <td>1</td> </tr> <tr> <td>DataBits</td> <td>8</td> </tr> <tr> <td>Handshake</td> <td>None</td> </tr> </table> <p> The COM1 port is only available on version 2 hardware.</p>	Baud Rate	115200	Parity	None	StopBits	1	DataBits	8	Handshake	None
Baud Rate	115200										
Parity	None										
StopBits	1										
DataBits	8										
Handshake	None										
Network and RS232	Uses both the network and the RS-232 serial port COM1 for APIs.										

To set the communication method for APIs:

1. In the API Connection pane on the Global Settings page, select the desired setting.
2. Click **Save API**.
3. When prompted, click **OK** to acknowledge the system has to be restarted the system.
4. In the Restart System section of the System Settings page, click **Restart System**.
5. When prompted, Click **OK** to start the restart or click **Cancel** to cancel the request.

How to Force SSL

This option is used to force all web connections to use SSL. When an SSL certificate is used, the data passed between the server and the client becomes unreadable to everyone except for the server you are sending the information to.

 API connections do not use SSL; enabling SSL authentication will disable API connections.

To set the Force SSL:

1. In the Force SSL pane on the Global Settings page, select the desired setting.
2. Click **Save SSL**.
3. When prompted, click **OK** to acknowledge the system has to be restarted the system.
4. In the Restart System section of the System Settings page, click **Restart System**.
5. When prompted, Click **OK** to start the restart or click **Cancel** to cancel the request.

How to Set MTU

 This setting only impacts video and audio packets that are encoded by the Phoenix system, such as DVI sources, VNC sources, Remote Desktop sources, and Application sources.

This option is used to set the Maximum Transmission Unit size, which is the maximum size (in bytes) for a single data packet on the network. Larger packets decrease the bit rate. Valid values are: 1316, 1366, and 1410. Default value: 1410.

To set the MTU size:

1. Select the desired size.
2. Click **Save MTU**.
3. When prompted, click **OK** to acknowledge the system has to be restarted the system.
4. In the Restart System section of the System Settings page, click **Restart System**.
5. When prompted, Click **OK** to start the restart or click **Cancel** to cancel the request.

How to Set TTL



This setting only impacts video and audio packets that are encoded by the Phoenix system, such as DVI sources, VNC sources, Remote Desktop sources, and Application sources.

This option is used to set the number of hops that a packet is permitted to travel before being discarded by a router. Valid values for unicast packets are 6-64 (default: 64). Value values for multicast packets are 1-5 (default: 5).

To set TTL:

1. Select the desired size.
2. Click **Save TTL**.
3. When prompted, click **OK** to acknowledge the system has to be restarted the system.
4. In the Restart System section of the System Settings page, click **Restart System**.
5. When prompted, Click **OK** to start the restart or click **Cancel** to cancel the request.

How to Restore the Last Wall Layout after Restart

This option is used to specify if the last wall layout should be restored after restarting the controller.

1. Click **Yes** or **No**.
2. Click **Save Last Layout**.
3. When prompted, click **OK** to acknowledge the system has to be restarted the system.
4. In the Restart System section of the System Settings page, click **Restart System**.
5. When prompted, Click **OK** to start the restart or click **Cancel** to cancel the request.

How to Set the Source Startup Style

This option sets the default style for the sources that are not outputting when starting up the system.

1. Click **Grey Bars** or **Black**.
2. Click **Save Style**.
3. When prompted, click **OK** to acknowledge the system has to be restarted the system.
4. In the Restart System section of the System Settings page, click **Restart System**.
5. When prompted, Click **OK** to start the restart or click **Cancel** to cancel the request.

How to Set the Wall Cursor Size

This option specifies the size of the cursor that is displayed on the wall when using Interaction Mode.

To control the size of the cursor for the display wall:

1. From the Wall Cursor Size pane on the Global Settings page, click the desired option button (normal (12x19 pixel), large (19x30 pixel), or extra large (28x43 pixel)).
2. Click **Save Cursor Size**.

How to Set the Wall Mouse Timeout

This option is used to specify the timeout settings for the mouse cursor on the display wall when using Interaction Mode. The settings enable you to always leave the mouse on or off; or set a timeout delay to turn the mouse off after a specified period of inactivity.

To control the timeout of the display wall mouse:

1. From the Display Wall Mouse Timeout pane on the Global Settings pane, click the desired option button (always leave mouse on, always leave mouse off, or auto delay mouse by a specified number of seconds).
2. Click **Save Mouse Timeout**.



The auto delay mouse option displays the mouse until the timeout period expires.

How to Display the Mouse on a KVM Layer

This option is used to specify the display of the mouse cursor on a KVM layer when using Interaction Mode. When Yes is selected, the wall cursor is displayed when interacting with a source; this results in two cursors being displayed when the mouse is moved over the source; one is the wall cursor and the other is cursor from the mouse directly connected to the source. If No is selected, only the wall cursor is displayed on the wall.



For VNC sources, the mouse cursor is displayed as a small dot (rather than an arrow pointer). To change this, refer to [Change the Cursor Shape for VNC Sources](#), page 189.

To control the display of the mouse on a KVM layer:

1. From the Display Mouse vs. KVM Layers pane on the Global Settings page, click the desired option button (yes or no).
2. Click **Save KVM Settings**.

How to Activate/Deactivate Controller Redundancy

This option is used to turn controller redundancy on or off for a system consisting of more than one node, and to clear the alert message if a controller fails and another node assumes the role.



Still images are not preserved through a controller switchover when a controller fails and controller redundancy is activated. They need to be added as sources on the new controller.

To activate controller redundancy:

1. From the Controller Redundancy pane on the Global Settings page, select the **Yes** button.

2. Select a backup controller from the Redundant Controller Preference list.
i If a system fails and the backup controller is promoted to primary you will need to select a new backup controller.
3. Select an Alert Timeout. The alert is displayed on the wall for the selected amount of time.
4. Click **Save Redundancy Settings**.
5. Wait 10 minutes.
6. Restart the controller.

To deactivate controller redundancy:

1. From the Controller Redundancy pane on the Global Settings page, select the **No** button.
2. Click **Save Redundancy Settings**.
3. Restart the controller.

How to Clear the Alert

To clear the alert message from the associated walls, click **Clear Controller Swap alert (shown on the wall)**.

i This link is visible only when there is an active alert.

Back up the System

The backup option creates a .PBF file that backups the configuration for nodes, walls, sources, wall layouts, source treatments, users, desktop workspaces for all users, favorites, recent wall list, and Web Manager global settings on the controller.

i The Desktop Client settings are stored on the PC and are user specific; they are not backed up using this feature.

The file name format is:

PhoenixBackup m_d_yyyy (month, day, year)

The file with the most current date and time stores the latest system configuration.

How to Back up the System

To create a backup of your system:

1. In the Backup System/Restore Points pane of the System Settings page, click **Backup System**.

Backup System/Restore Points

Save your system configuration by creating a new restore point.

Backup System...

- or -

Browse your computer to find a different restore point and to overwrite your current system configuration:

⚠ BEWARE: This process will completely overwrite your current system configuration. **Select...**

- When prompted to open or save the file, click Open, Save, Save as, Save and open, or **Cancel** (some of these options are browser specific).

Do you want to open or save **PhoenixBackup 1_9_2013.pbf** from 10.2.1.19? Open Save ▾ Cancel x

i The default location for the PBF file is the Downloads folder. Click on the arrow next to Save to access the options to Save as, or Save and open the file.

i To manage your backup files, you can create a new folder to store the files.

- When the download is complete, you can open the file, open the folder where the file is located, view the downloads list, or close the dialog (some of these options are browser specific).

The PhoenixBackup 2_12_2013 (2).pbf download has completed. Open ▾ Open folder View downloads x

Restore the System

You should restore your system when a problem occurs and the system needs to be restored to a restore point.

Before restoring a system, try to resolve the problem using the **Restart System** option (refer to [Restart the System](#), page 126). The restore option should only be used when a restart is not successful.

- !** The restore process completely overwrites your current system configuration.
- The restore process initiates a restart of all the nodes connected to the controller.
- Verify all users are logged off before starting the restore process. Restoring the system should not be performed when any changes are being made to the system configuration.
- Do not perform a firmware update when a backup or restore operation is in progress.

How to Restore the System

To restore the system, you must have a backup file (*filename.PBF*). Refer to [Back up the System](#), page 123.

To restore the system:

- In the Backup System/Restore Points pane of the System Settings page, click **Select** to select the backup file you want to use to restore your system.

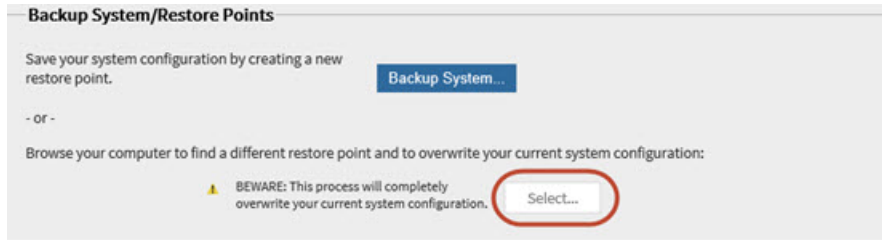

2. When prompted, confirm you want to restore the system.
3. When the restore completes, log in to the system.

Restart the System

The restart option should be used to restart all the nodes connected to the controller and restart the display wall if you encounter any problems with the system. Before using this option, you can also try to restart a specific node from the Edit Node page.



- The restart process initiates a restart of all the nodes connected to the controller. Make sure your changes are saved.
- Verify all users are logged off before starting the restart process.
- Do not perform a firmware update when a restart process is in progress.

To restart the system:

1. In the Restart System section of the System Settings page, click **Restart System**.

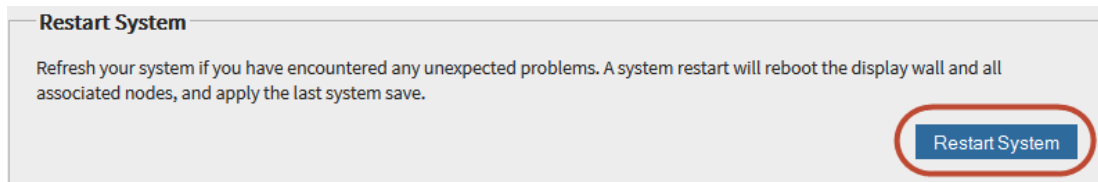

2. When prompted, Click **OK** to start the restart or click **Cancel** to cancel the request.

Wipe System (Restore to factory defaults)

The Wipe System option should be used to restore your system to the default factory settings when all other recovery efforts have failed. Before using this option, perform a system restart (refer to [Restart the System](#), page 126); if that does not resolve your problem, perform a system restore ([Restore the System](#), page 125).

The wipe system process completely overwrites your current system configuration including sources, wall treatments, wall layouts, user profiles, thumbnails, background images, etc. If the **Also remove walls** check box is selected, the configuration for all walls is deleted.



- The controller role assignment is preserved throughout this process.

If you select the **Also remove walls** check box, the configuration for all walls will be deleted. If you do not check it, the configuration of all walls will be preserved.

This procedure restarts the controller.



- The wipe system process initiates a restart of all the nodes connected to the controller.

Verify all users are logged off from both the Desktop Client and the Web Manager before starting the wipe system process. Wiping the system should not be performed when any configuration changes are being made.
Do not perform a firmware update when a wipe system process is in progress.

How to Restore to Factory Defaults

To restore the system to the factory defaults, in the Wipe System (Restore to factory defaults) pane of the System Settings page, perform the following:

1. To remove wall layouts, select the **Also remove walls** check box. To preserve any configured walls, verify this check box is cleared.
2. Click **Wipe System**, and then click **OK** to start the process or **Cancel** to cancel the request.

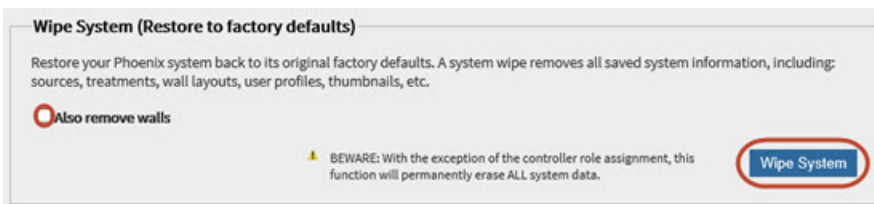

Directory Services

Directory service integration with Phoenix allows groups to be set up with access rights to sources and walls. There are two options for using directory service:

- Phoenix Directory
- Active Directory (AD)

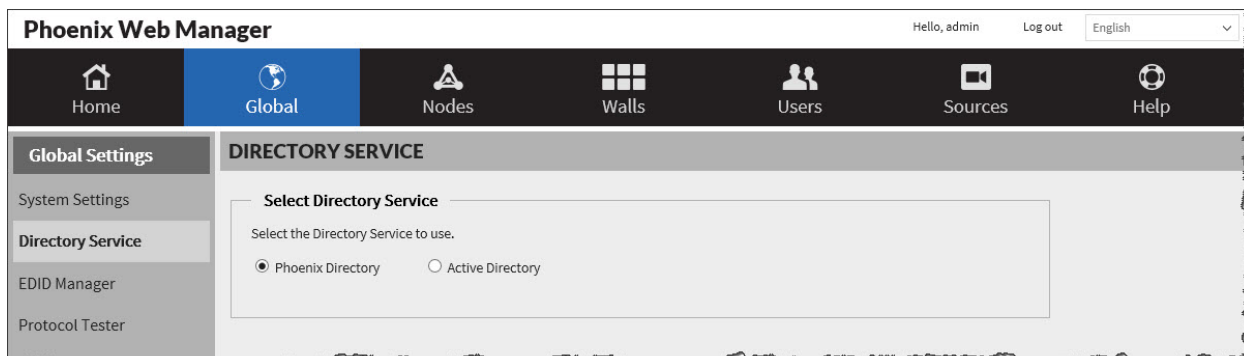

Phoenix Directory is used to create groups to access the Phoenix system. This is the default setting.

Active Directory settings are used when users access the Phoenix system using their network user login and password. A dedicated Active Directory server is required.

When Phoenix Directory is configured, it functions the same as Active Directory.

To implement directory services:

1. Create an implementation plan.
2. Create user, administrator, wall, and source groups using logical names.
3. Assign sources to source groups.
4. Assign walls to wall groups.

5. Assign administrators to administrator groups.
6. Assign users to user groups.
7. Assign user groups to source groups and wall groups.

Manage Phoenix Directory Service

Use this page to configure Phoenix Directory Service for Desktop Client users. Once enabled users can use their user name and password for authentication for the Phoenix system.

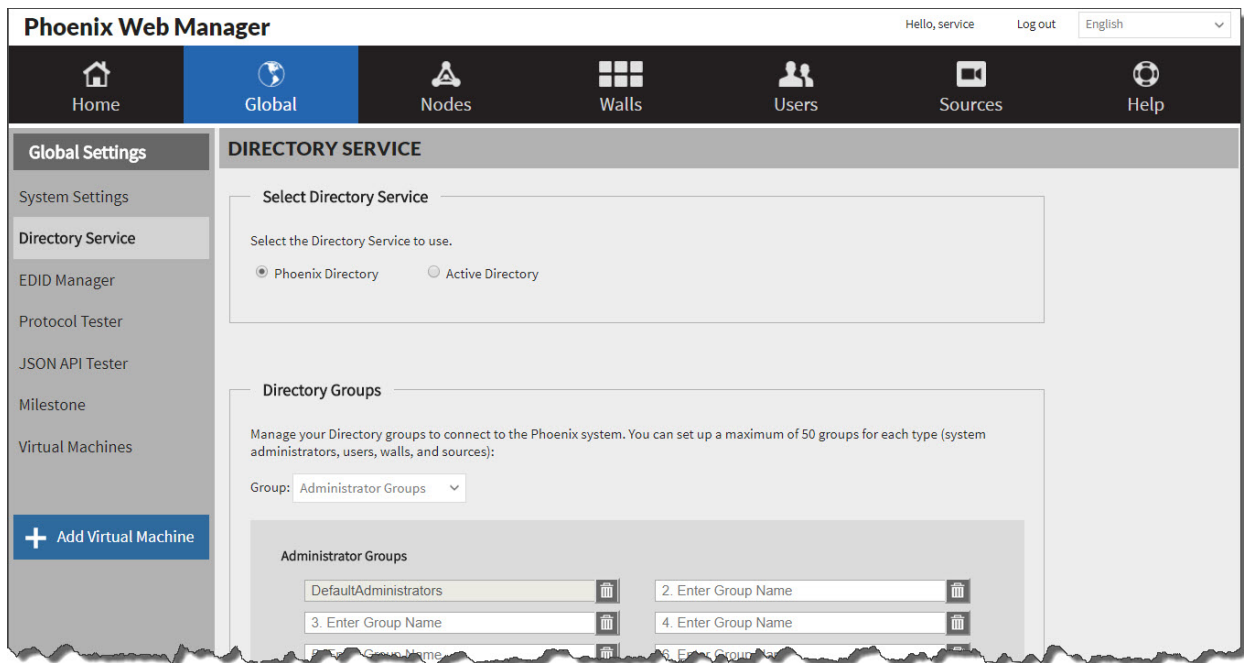

Use this page to:

- Enable Phoenix directory
- Set Phoenix directory administrator and user groups
- Set default source and wall groups

Refer to [Managing Groups](#) (page 128) for more information.

Managing Groups

There are two types of users:

- Users with access to the Desktop Client and Phoenix Quick Control only.
- Administrators with access to the Desktop Client, Phoenix Quick Control, and the Web Manager.

The directory administrator should create new groups or select one or more existing groups that represent the two types of users. Users then use their user ID and password when using the Phoenix system. The administrator configures group names that allow members of those groups to access the Desktop Client, Phoenix Quick Control, and/or the Web Manager.



The default groups cannot be deleted.

All group names must be unique. For example, you cannot have a source group named Christie and a wall group named Christie.

There are default groups for each type of directory groups (administrator, user, source, and wall). When a user is added to one of these groups, the user is automatically assigned to the default group. Group members can be assigned to additional groups.

- Members of the default administrator group (DefaultAdministrators) have full access to the system and can manage all walls, sources, users.
- Members of the default user group (DefaultUsers) have full access to the Desktop Client and Quick Control.
- Members of the default source groups (DefaultSourceGroups) have full access to all sources and can manage all sources using the Desktop Client or Phoenix Quick Control.
- Members of the default wall groups (DefaultWallGroups) have full access to all walls and can manage all walls using the Desktop Client or Phoenix Quick Control.

To restrict access to users, sources, or walls:

1. Create new groups that include the specific items.
2. Remove the items from the default groups.
3. Assign users to the new groups.



The administrator also configures the group names to allow members of those groups access to the sources and walls. If a user belongs to a group that is configured for the Phoenix system administrator access, they can access all users, sources and walls. Users who do not belong to those groups have access to the Desktop Client and Phoenix Quick Control and access to sources and walls that was granted by the administrator.

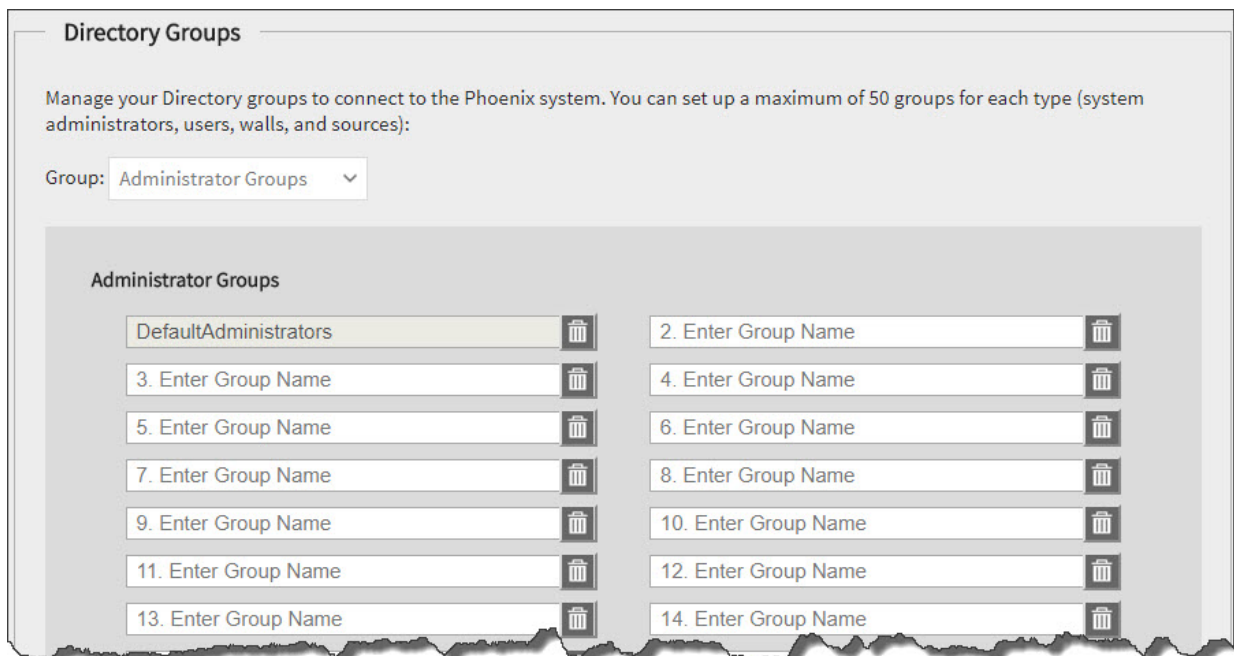

If any updates are made to a user’s access rights, they will not be applied until the user logs off and logs back on.



Directory Groups

Group	<p>Used to set up the group types. Valid groups are: users, administrators, sources, and walls. You can set up a maximum of 50 groups for each type.</p> <p>To delete a group, select .</p> <p> To access walls and sources in the Desktop Client or Phoenix Quick Control, users should be added to the user group, source group, and wall group.</p>
-------	--

Default Groups

Group: User Groups ▼

Available User Groups

- DefaultUsers
- user1
- user4

Default User Groups

← →

Default Groups

Group	Used to select the type of group for setting up the default groups. Valid group types are: administrator, users, sources, and walls.
Available and Default Groups	Used to select groups for the default users, sources, or walls groups. Select a group to transfer it between the available and default groups.

Manage Active Directory Settings

Active Directory (AD) is supported using the Lightweight Directory Access Protocol (LDAP) over a Secure Socket Layer (SSL) (LDAPS). The Phoenix system requires a user (and corresponding password) with enough permissions to query the AD server.

 External access to the Phoenix system using a third-party controller is only supported using the serial RS-232 port when the Phoenix system is configured to use Active Directory.

Use this page to configure Active Directory Domain Services for Desktop Client users. Once enabled users can use their domain name and password for authentication for the Phoenix system.

The user account used to authenticate Active Directory should have the lowest privileges. It is recommended the new user have read-only Active Directory privileges and no other privileges in the domain.

Use this page to:

- Enable active directory

- Set the active directory account credentials
- Set active directory groups
- Set default source and wall groups

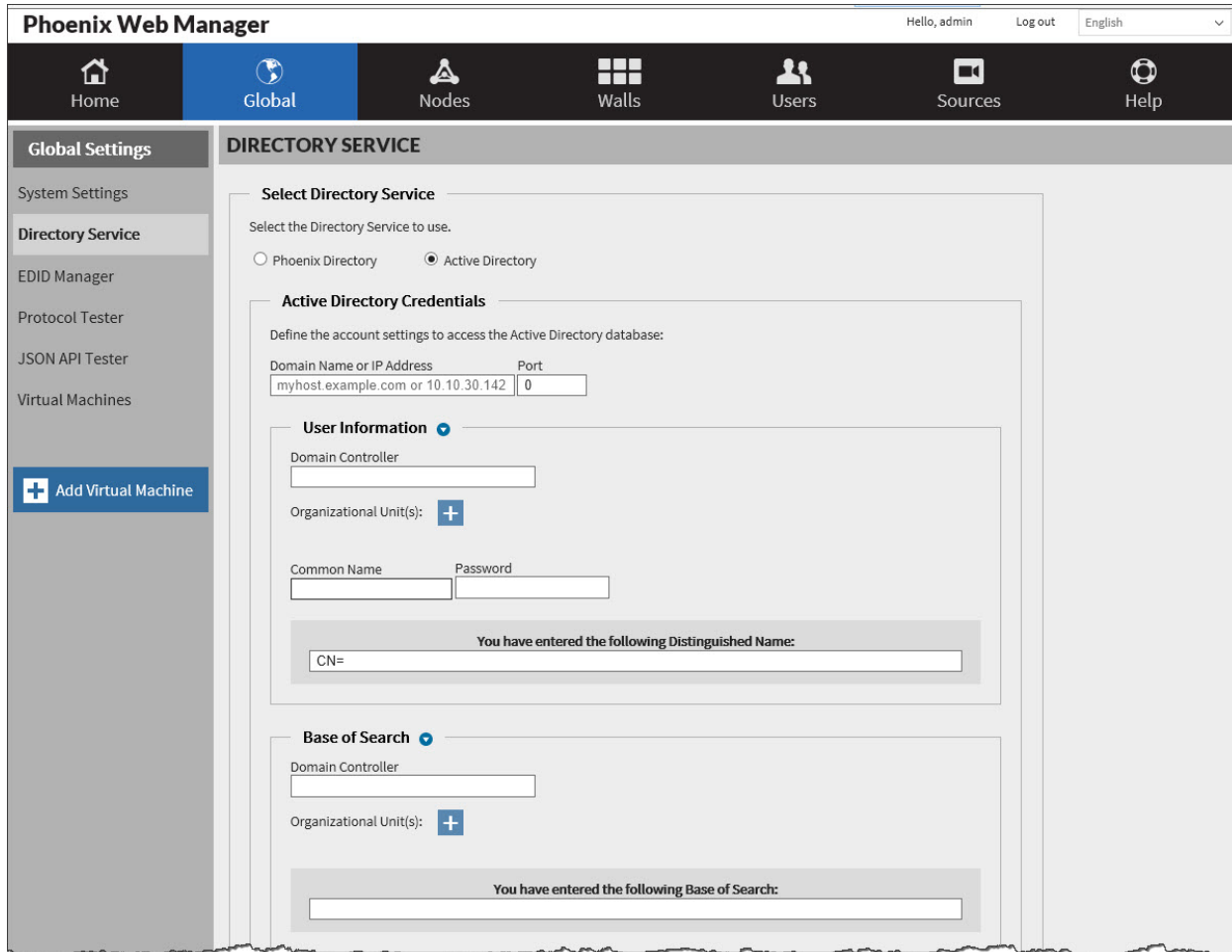

Distinguished Name Base ▼

Domain Controller

Organizational Unit(s): +

You have entered the following Distinguished Name Base:

Directory Groups

Manage your Directory groups to connect to the Phoenix system. You can set up a maximum of 50 groups for each type (system administrators, users, walls, and sources):

Group:

Administrator Groups

<input style="width: 90%;" type="text" value="DefaultAdministrators"/>	<input style="width: 90%;" type="text" value="2. Enter Group Name"/>
<input style="width: 90%;" type="text" value="3. Enter Group Name"/>	<input style="width: 90%;" type="text" value="4. Enter Group Name"/>
<input style="width: 90%;" type="text" value="5. Enter Group Name"/>	<input style="width: 90%;" type="text" value="6. Enter Group Name"/>

Refer to [Managing Groups](#) (page 128) for more information.

Synchronizing Changes with Active Directory

If changes are made that impact the Active Directory configuration, the administrator is notified when selecting **Save**. This notification occurs when a security group does not exist in Active Directory. A sample notification follows:

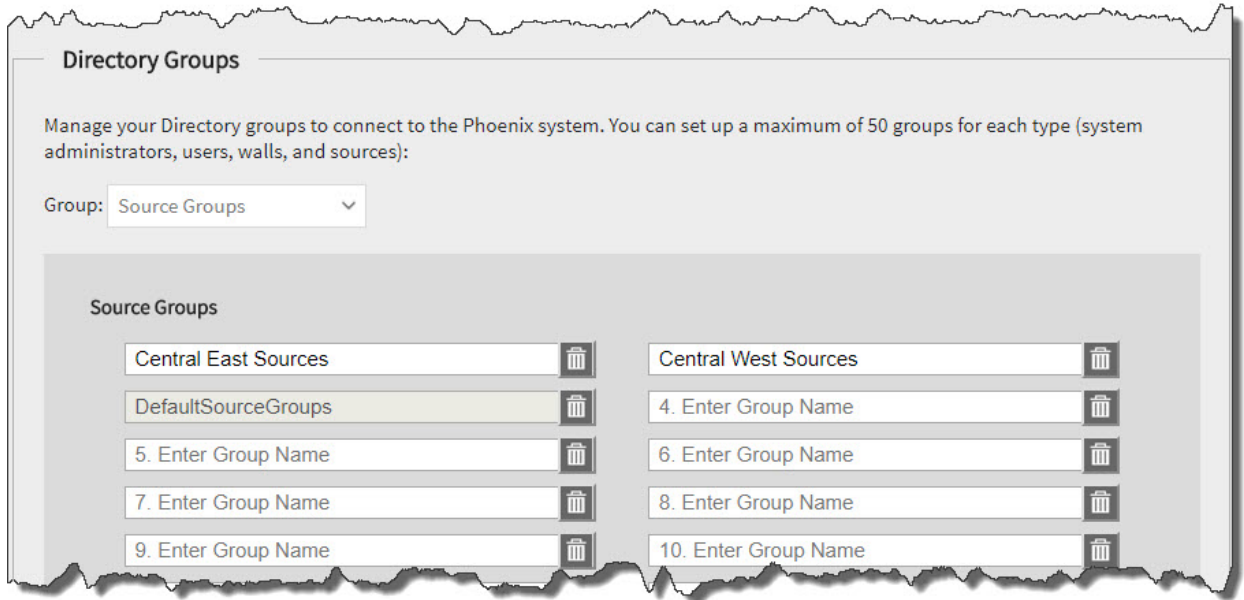

The administrator is prompted to review the inconsistency and resolve it. The following is an example of a change:

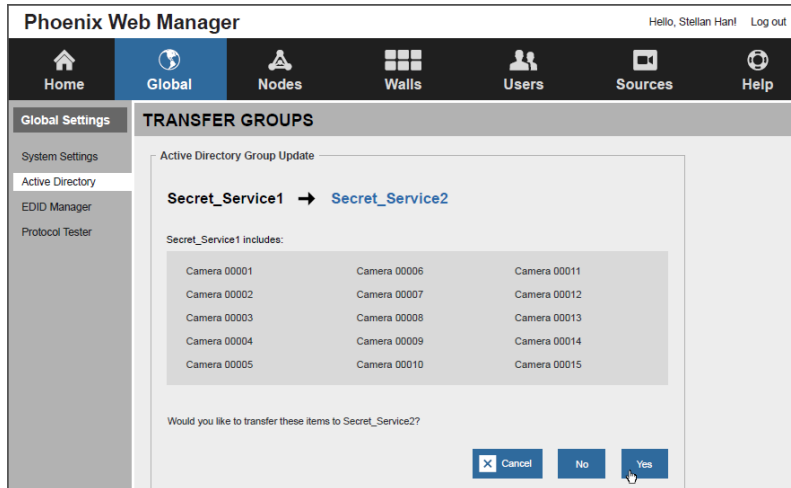

The following is an example of a deletion:

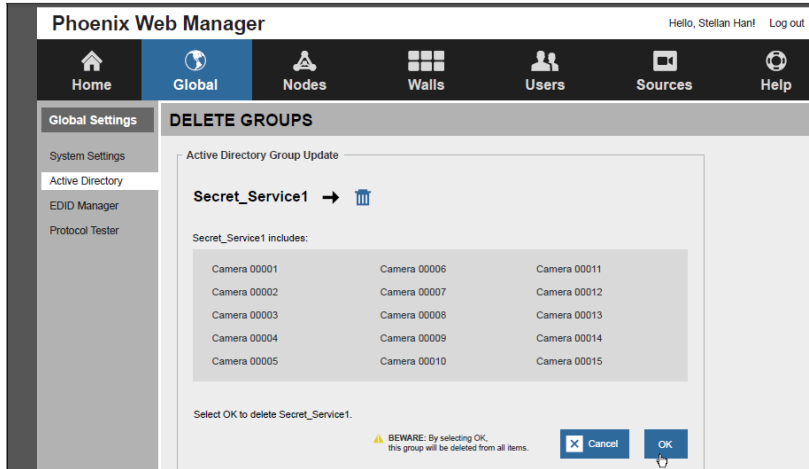

When a change in the Active Directory configuration in the Phoenix system occurs, an administrator can accept or reject the change.



If a change in Active Directory permissions impacts users, they should log out and log back in.

How to Set the Active Directory Account Credentials



1. To enable the Active Directory feature, select **Yes**. By default, Active Directory is not enabled.
2. Configure the details using the information in the following table.
3. Select  to expand a section on the page or  to collapse a section.
4. Click **Save**.

Table 16 – Active Directory Credentials



Field	Description
Domain Name or IP Address	The identifier for the Active Directory server.
Port	Network port for Active Directory. The default port is 636.
User Information	
Domain Controller	Domain name of your server (e.g. sub.domain.com) hosting the Active Directory service.
Organizational Units	Used to organize users. Each Organizational Unit can have a maximum of 64 characters. The Organizational Units are nested under the Domain Controller. Select  to add additional units.
Common Name	One of the attributes for the Distinguished Name. Common Name, Organizational Units, and the Domain Controller are used to create the Distinguished Name. Distinguished Names can have a maximum of 255 characters (e.g., CN=John Testing,OU=CorporateVicePresidents,OU=CorporateOfficers,OU=ViewOfP ugetSoundOffices,OU=TopFloor,OU=Building123,OU=CorporateCampus,OU=Redmond,OU=Washington,OU=NorthWestern,OU=UnitedStatesOfA merica,OU=NorthAmerica,OU=LongNameTests,DC=phoenix,DC=local).
Password	Password associated with the common name. To change the password, select Change Password , enter the new password, and then select Save .

Table 16 – Active Directory Credentials

Field	Description
Base of Search	
Domain Controller	Domain name of your network (e.g. sub.domain.com).
Organizational Unit	Used to specify the Organizational Unit to be used as the starting point for directory server searches. Select  to add additional Organizational Units (e.g., NorthAmerica/UnitedStates/Arizona).
Distinguished Name Base	
Domain Controller	Domain name of your network (e.g. sub.domain.com).
Organizational Unit	Used to specify the Organizational Unit to be used as the as the starting location to authenticate users. Select  to add additional Organizational Units (e.g., NorthAmerica/UnitedStates/Arizona).
Directory Groups	
Group	Refer to Managing Groups (page 128) for more information.

Manage EDID Configurations

The inputs on a Phoenix node conform to the Extended Display Identification Data (EDID) standard defined by the Video Electronics Standards Association (VESA). This standard is a data structure provided by a display device to describe its capabilities to a PC graphics card. The EDID configuration includes information such as the manufacturer name and video timings supported by the display.

In certain cases, it may be favorable to use the EDID configuration from a display wall or from a file to modify the EDID data stored within the Phoenix node inputs (e.g., to get a desired resolution from a PC). The EDID Manager enables you to:

- Mirror the EDID configuration of an existing wall.
- Import a different configuration from an EDID configuration file.
- Select the inputs from the list to apply the EDID configuration to one or more inputs.

When the **Mirror the EDID configuration of an existing wall** option is selected, the EDID configuration is copied from the display attached to the output connector to the inputs.

How to Manage EDID Configurations

To select an EDID Source:

1. From the Global Settings page, click **EDID Manager** in the page navigation pane.
2. Perform one of the following:
 - a. Select **Mirror the EDID configuration of an existing wall**, and then select the desired wall from the dropdown list.
 - b. Select **Import an existing EDID configuration**, and then click **Select** to browse to a valid file name.
3. Select one or more inputs by clicking on the input in the Choose Inputs pane.



To select more than one input, hold down the Ctrl key and select additional inputs.

4. Click **Update EDID**.

Using the Protocol Tester

The protocol tester is designed for 3rd party control developers to test commands against the Phoenix system.

The protocol tester sends commands to the external control port (TCP port 11135) of the controller and displays the results.

The Protocol Tester provides an external control protocol that can be used when developing customized control systems and user interfaces. These control systems are generally found in installations where the Phoenix system is only one of several disparate systems combined to form a larger system.

Refer to the Phoenix System External Control Protocol Reference Manual (020-101425).

Using the JSON API Tester

The JSON protocol tester is designed for 3rd party control developers to test commands against the Phoenix system.

The protocol tester sends commands to the external control port (TCP port 23456) of the controller and displays the results.

The JSON Protocol Tester provides an external control protocol that can be used when developing customized control systems and user interfaces. These control systems are generally found in installations where the Phoenix system is only one of several disparate systems combined to form a larger system.

Refer to the *Phoenix System External Control Protocol (JSON) Reference Manual* (020-000965).

Use this page to test an API command and view the results before implementing the command.

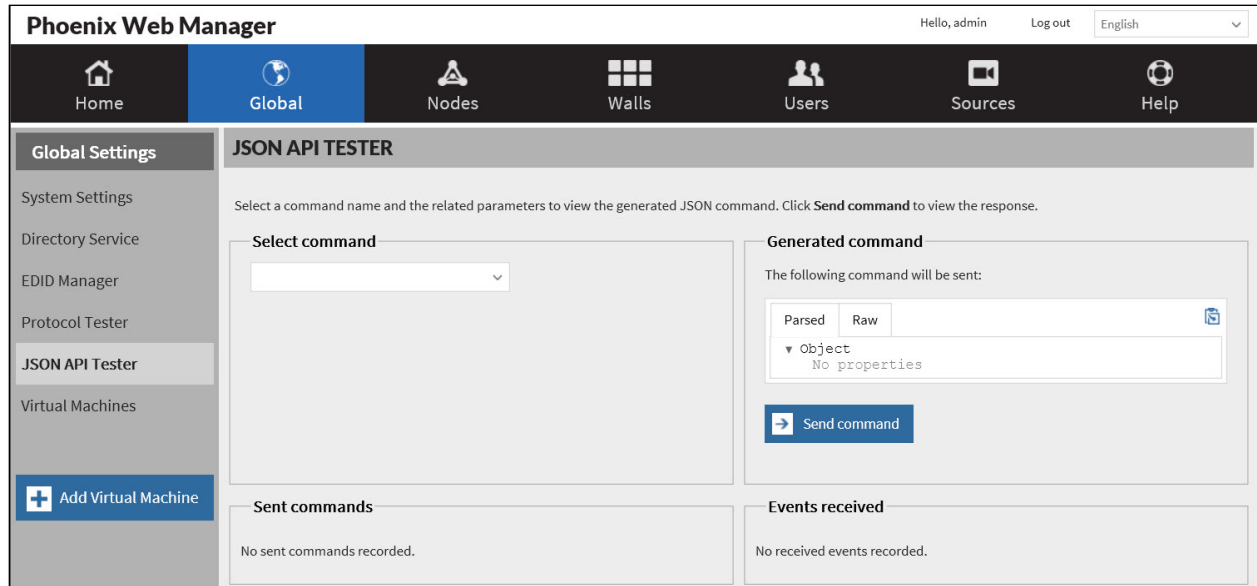

How to Connect to a Milestone Server

To connect Milestone sources to the Phoenix system and to map Milestone events to wall layouts, you have to provide the IP address of the server that hosts the Milestone sources and the credentials for the server (user name and password).

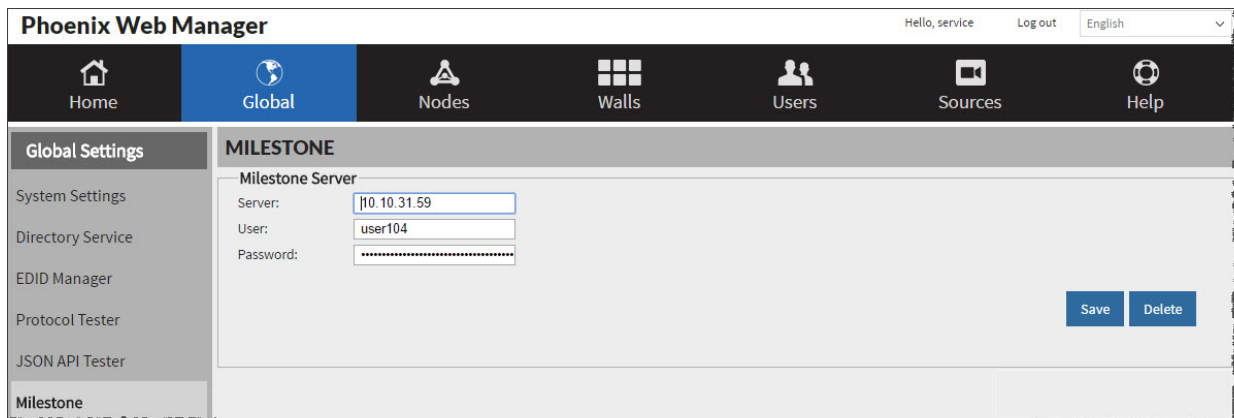

To connect to the server:

1. Type the IP address of the server.
2. Type the user name and password.



It is recommended to add a dedicated user for the Phoenix system.

3. Click **Save**.

How to Map Milestone Events to Phoenix Wall Layouts

When Phoenix is connected to the Milestone server, Phoenix queries the Milestone server to find the user-defined events for Phoenix. Use the Milestone Events pane to assign the events to Phoenix layouts on specified walls.

The screenshot shows the Phoenix Web Manager interface. The top navigation bar includes Home, Global (selected), Nodes, Walls, Users, Sources, and Help. The left sidebar lists various settings and management options, with 'Milestone' selected. The main content area is titled 'MILESTONE' and contains two sections: 'Milestone Server' and 'Milestone Events'.

Milestone Server section includes input fields for Server (http://10.10.31.59), User (user104), and Password (masked). There are 'Save' and 'Delete' buttons.

Milestone Events section features a table with columns: Wall, Layout, Event Name, and an action icon.

Wall	Layout	Event Name	
Wall 1	Layout1	TestEvent	

Below the table are three dropdown menus: 'Select a Wall' (Wall 1), 'Select a Layout' (Layout1), and 'Select a Milestone Event' (TestEvent). A 'Save' button is located at the bottom right of this section.

To assign events to Phoenix walls and layouts:

1. In the Milestone Events, select a wall.
2. Select the desired layout to be associated with the event.
3. Select the Milestone event.
4. Click **Save**.

How to Add a Virtual Machine

What you need: Terminal server (Windows Server version 2008 and higher) running Remote Desktop Protocol and a valid user name and password to access the server. The user needs the appropriate security clearance. Contact your network administrator for this information. The browser you will use to access the application source needs to be installed on the server. Client Access License (CAL) is required for clients to connect to the terminal server.

What is supported: Web pages and interaction with the source.

A remote desktop source enables you to access a remote computer that is on the network using Microsoft Remote Desktop Protocol (RDP).

Table 17 – Virtual Machine Fields

Field	Description	
Virtual Machine Info	User Name	User name to log into the virtual machine. The user name must be unique.
	Password	Password for the user name.
	IP Address	The IP address of the virtual machine. Valid format is IPv4.
	Port	The port number associated with the IP address of the virtual machine. The default port number is 3389.

Phoenix Quick Control

Phoenix Quick Control is an HTML-based interface (commonly referred to as an app) used to recall layouts and change sources. It provides dynamic control over a Phoenix system using a browser from PCs or smart devices.

Phoenix Quick Control is used to manage wall layouts using a touch-enabled device. Available features include:

- Change the active layout for a wall.
- Swap sources on a wall.
- Change the treatment for a source.
- Change the audio source for a wall.

The walls, layouts, sources, treatments, etc. are created and configured using the Phoenix Web Manager and Phoenix Desktop Client. When using Phoenix Quick Control, you should observe the wall you are managing to view your changes to the wall.

Accessing Phoenix Quick Control

To access Phoenix Quick Control, you must be configured as a user or admin in the Phoenix Web Manager and your device must be connected to the same network as the Phoenix controller. If you have admin privileges, click **Phoenix Quick Control** under Global Settings to access Phoenix Quick Control. If you are a user, login in to the Web Manager using your user name and password to access Phoenix Quick Control.

Supported devices

You can access the app using a web browser on a touch-enabled PC, laptop, tablet, or smartphone.

Select preferences

The preferences option enables additional features including audio and source options. It is best to only enable the options you plan on using.

The **Display audio options** enables you to change the audio source for the wall.

The **Enable source management** enables you to swap a source on the selected wall and optionally apply a treatment to any source on the wall.

Selecting a wall

To select a wall to view or modify, click the name or graphical illustration for the wall. The preconfigured layouts for the wall are displayed. Select the desired layout to update your wall.



To view a wall, you must be set up with rights management of access to walls in Phoenix Directory Services. Refer to [Directory Services](#), page 127.

Swapping a source on a layout

To swap a source on a layout:

1. Select the wall (single click).
2. Select the layout (single click) to modify.
3. From the **Actions** pane, select the **Recall layout name**.
4. Select the source you want to change.
5. Click **Change source**.
6. Click the replacement source from the **Change source** list.
7. Click **Apply**.

Applying a treatment to a source

To apply a treatment to a source:

1. Select the wall (single click).
2. Select the layout (single click) to modify.
3. From the **Actions** pane, select the **Recall layout name**.
4. Select a source to change the treatment.
5. Click **Apply treatment**.
6. Click the treatment from the **Apply treatment** list.



To filter the treatments, click in the **Filter treatments** field and type the text to filter on.

7. Click **Apply**.

Desktop Client

The Desktop Client is used to design content for walls and subwalls that were configured using the Phoenix Web Manager.



The term *wall* in this documentation refers to both walls and subwalls.

The user interface for the Desktop Client uses standard Windows conventions (e.g., click, double-click, right-click menus, tooltips, ribbons and tabs, and drag and drop). These conventions provide flexibility – offering users multiple ways to do a single task. For example, to view a source you can double-click on a source; or you can right-click on it to open the source on your desktop or in a wall simulator. This type of flexibility exists throughout the user interface.

In addition to using standard Windows conventions, the user interface includes some unique features. The user interface consists of multiple independent lists that can be docked together or arranged on your desktop to your liking. When you set up a desktop you like, you can save it for future use as a workspace. You can save multiple workspaces and then quickly access a workspace to help you work efficiently.

You interact with the Desktop Client software using the wall simulator and the main lists. The main lists include:

- Sources
- Walls
- Layouts
- Treatments
- Favorites
- Users

The wall simulator provides a graphical representation of a wall that was configured using the Web Manager. You use the wall simulator to design your wall.

From the lists, you can perform common tasks, such as search for items, add items to favorites, delete items, and add new items (administrators only). The following graphics illustrate these common tasks and the flexibility of the user interface.

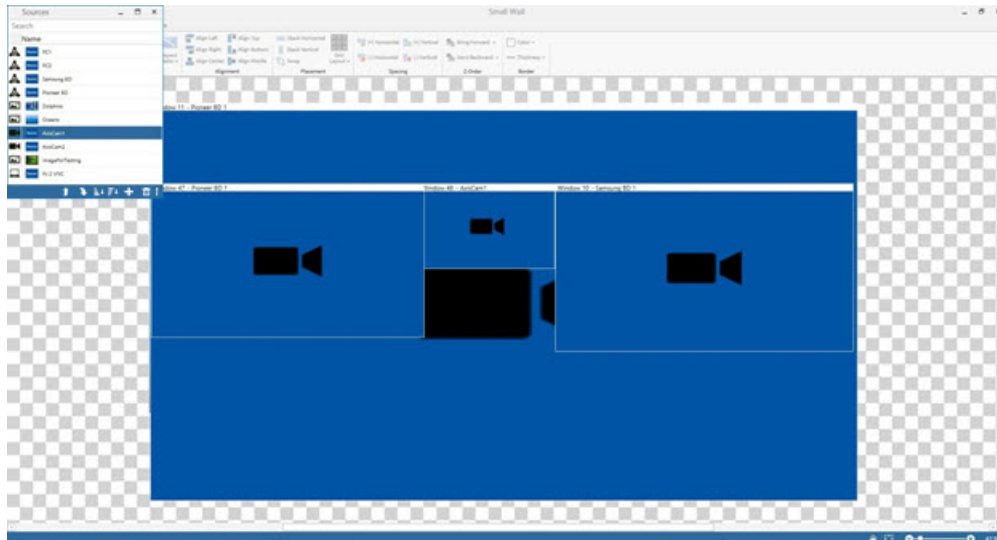

Figure 26 – Wall Simulator and Sources List, Not Docked

- | | | | |
|-----------|---------------------------|----------------------------------|-----------|
| 1. Search | 2. Open, Add to Favorites | 3. Add New (Administrators only) | 4. Delete |
|-----------|---------------------------|----------------------------------|-----------|

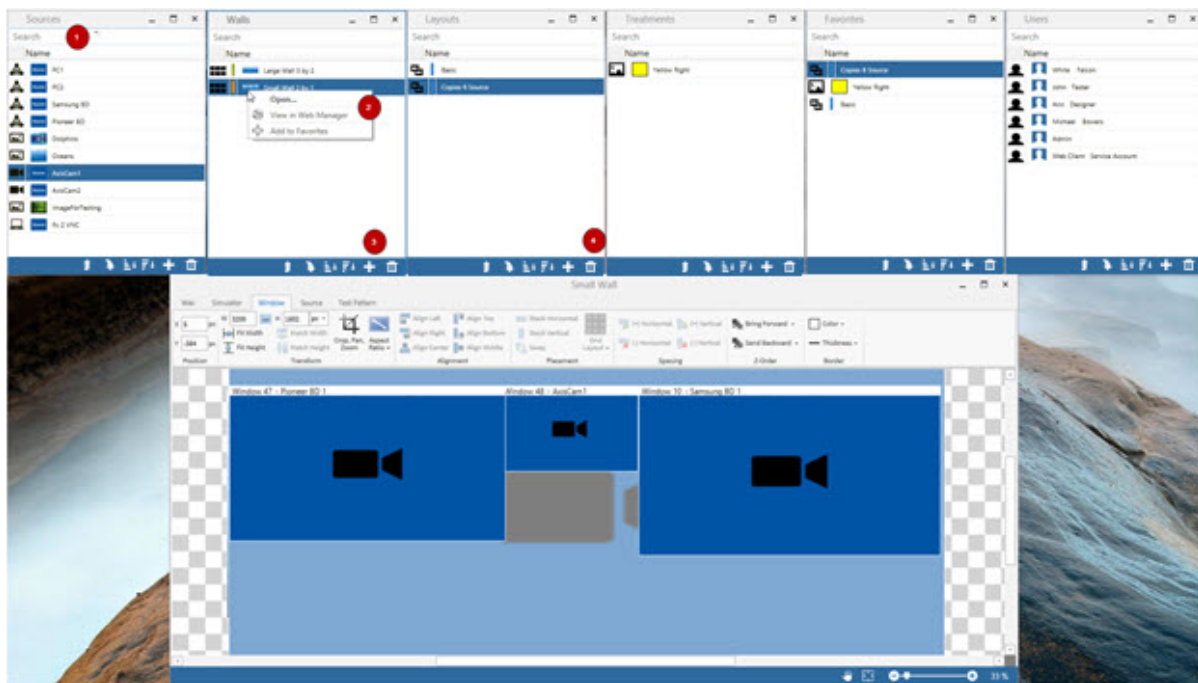

Figure 27 - All Lists Opened and Docked

The wall simulator has a control bar that can be used as follows:

Click	To
	Reposition the representation of the wall in the wall simulator.
	Reposition the representation of the wall to the center of the wall simulator.
	Change the zoom level of the representation of the wall in the wall simulator.

Install the Desktop Client

The Phoenix Desktop Client Setup software is used to install the Phoenix Desktop Client software. The software is launched from the Phoenix Web Manager login page.

How to Install Visual Studio 2012 Update

Prior to using the Desktop Client, you need to install the Visual C++ Redistributable packages for Visual Studio 2012 for both x86 and x64 from:

<http://www.microsoft.com/en-us/download/details.aspx?id=30679>

The Visual C++ Redistributable Packages install runtime components that are required to run C++ applications built with Visual Studio 2012.

How to Install the Desktop Client Software



The Desktop Client software can only be installed by administrators. If it is not installed by an administrator, the connection to a controller will fail.

To install the software:

1. Launch the Phoenix Web Manager software (refer to [Access the Web Manager](#), page 45).

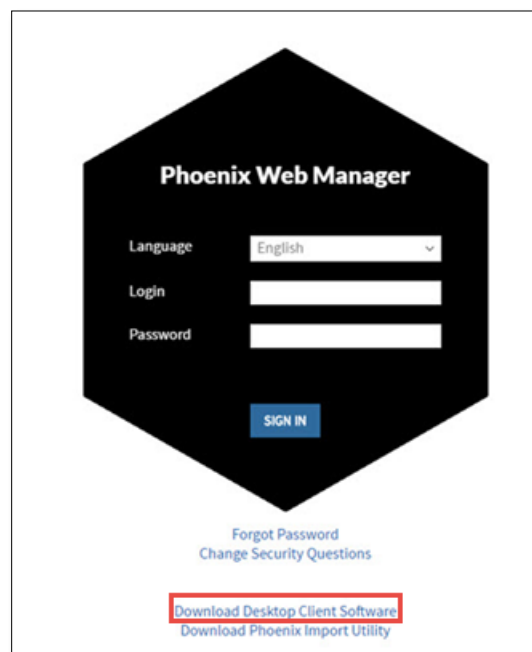

2. Click **Download Desktop Client Software** to download the software. Follow the prompts from your browser to complete the download.
3. Right click on the Desktop Client icon or the ClientSetup.exe file and click **Run as Administrator**.
4. When the setup software starts, select the desired language and click **OK**.

5. Accept the default location to install the software or use the browse button to select a different location; select the check box to agree to the terms and conditions; and then click **INSTALL**. Wait until the installation is complete.



6. Allow the program to make changes to your computer. When the software is installed, click **Run** to launch the software and close the wizard; or click **Finish** to exit the wizard.



If the Desktop Client software is already installed on your PC, if you attempt to install it, you will have the option to repair it or remove it.

If you want to downgrade to an older software version, you may have to first use the Windows “Uninstall or change a program” option on the Control Panel to remove the existing software, and then reinstall the older version.

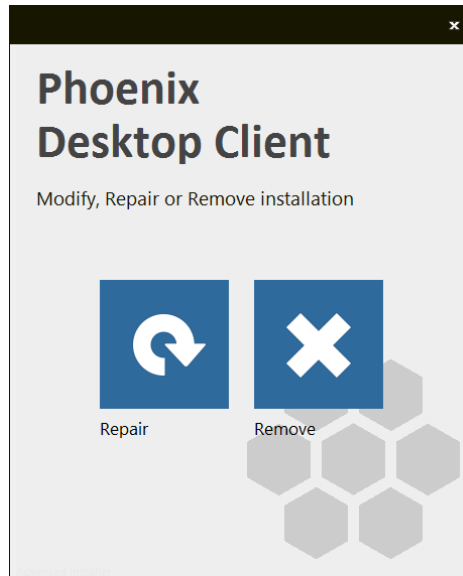

Starting the Desktop Client the First Time

Every time a different computer running the Desktop Client (version 1.6.0 or later) attempts to connect to a Phoenix Controller for the first time using Stringent security mode, you will have to send a request to establish trust. This includes controllers that you connected to with the previous software version.

To establish trust:

1. Sign in to a controller. You will be prompted to create a trust relationship with the server.



The Desktop Client will NOT connect until this relationship is established if Stringent security is enabled.

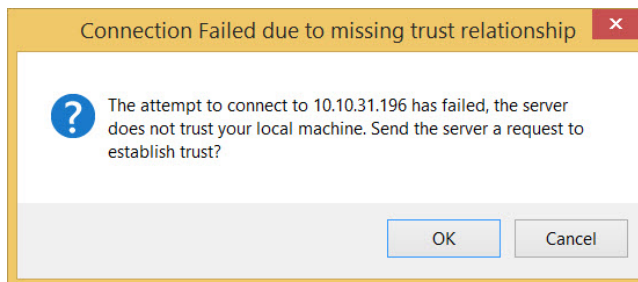

2. Click **OK**.
3. After sending the request (you will not receive a response from the request), sign in again to connect to the controller.

Start the Desktop Client

The Phoenix Desktop Client is designed to minimize into the notification area of the taskbar. It can be accessed from the task toolbar.

How to Start the Desktop Client

To start:

1. Click **Show hidden icons** to display all icons in the notification area.

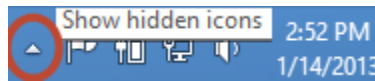

2. Click the Phoenix system icon (☼).

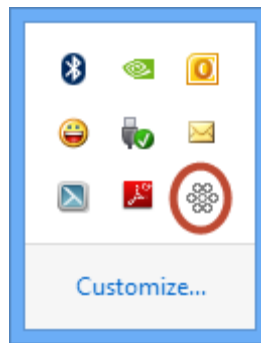

You can change the icon to always display in the taskbar by clicking **Show hidden icons**, and then click **Customize**. On the list of icons, scroll to PhoenixClient, change the setting to Show icon and notifications, and then click **OK**.

3. Select the IP address of the controller for your system by selecting the IP address from the list or type the IP address, type your user name and password, and then click **Sign In**.
4. Type your user name and password.
5. Optionally, select the **Remember Username?** check box to remember your user name.
6. Click **Sign In**.



If you are connecting to a controller using a wireless connection or if you are connecting to a controller from outside the subnet that the Phoenix system is connected to, you need to type the IP address of the controller in the Select Controller field (it will not be displayed in the list).



If the address is not listed, use the Phoenix Web interface to verify the node is configured as a controller.

Once logged in, the main menu is displayed.

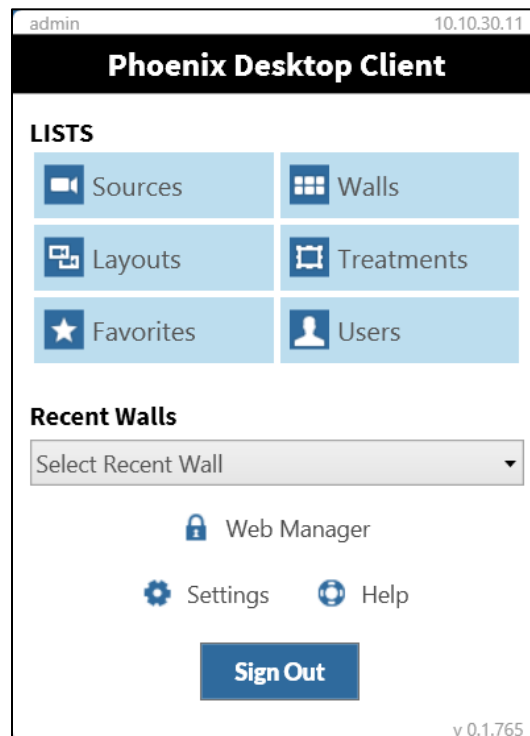

From this menu, you can open lists for sources, walls, layouts, treatments, favorites, and users; open a wall you recently viewed; access the settings for the Desktop Client; access help; and log out. Additionally, if you are an administrator, you can access the Web Manager by clicking **Web Manager**.



If these lists are open and you shutdown the Desktop Client, they reopen when you restart the Desktop Client.

Also, the IP address of the controller you are connected to, the name of the user who is currently signed in, and the software version are displayed on this menu.

To close all windows, right click on the Desktop Client icon in your task bar, and then select **Close all windows**.

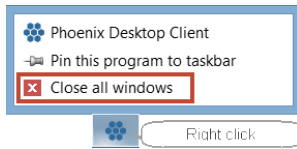

Phoenix Desktop Client Settings

The Desktop Client settings include:

- Enable Desktop Drag and Drop
- Remember Last Workspace
- Force Unicast (this is useful for viewing sources on your desktop when you are running the Desktop Client software on a PC that is located on a different subnet or network than the Phoenix System, default is on).
- Run the Desktop Client in the System Tray

How to Change the Desktop Client Settings

1. From the main menu, click on Settings to view or edit the settings for the Desktop Client.

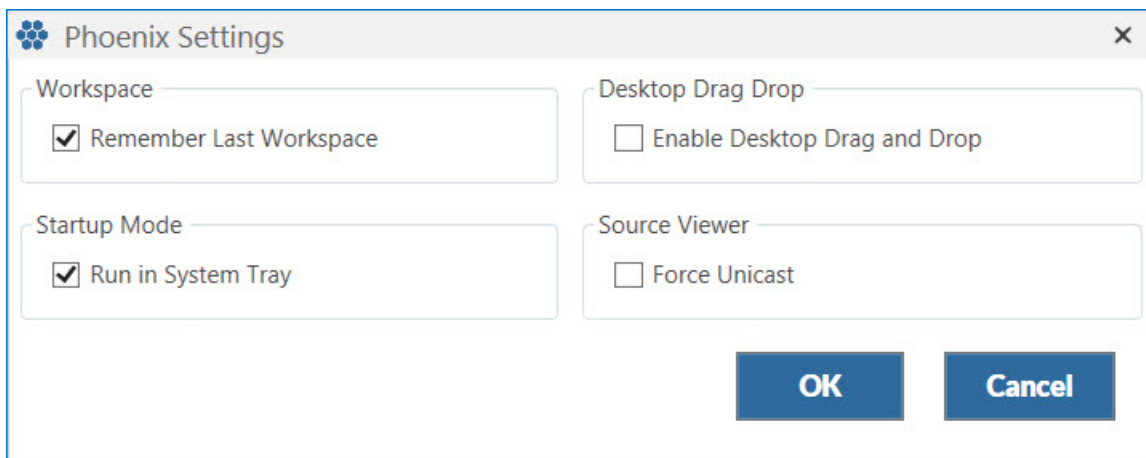

2. Make the desired changes.
3. Click **OK**.

How to Remember the Last Workspace

If this is not enabled, the location of the open windows (workspace) will not be stored on the computer you are running the Desktop Client on when you exit.

1. From the main menu, click **Settings**.
2. Select the **Remember Last Workspace** check box.
3. Click **OK**.

How to Enable Desktop Drag and Drop

Enabling Desktop Drag and Drop permits the dragging and dropping of sources to the desktop. The default setting is disabled.

1. Verify the display setting on your PC is set to the default setting (100%).

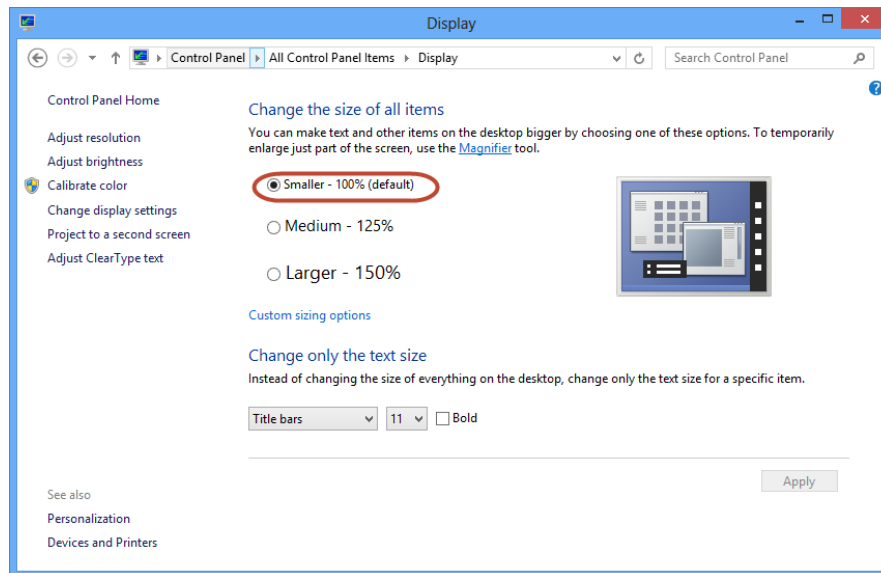

2. From the main menu, click **Settings**.
3. Select the **Enable Desktop Drag and Drop** check box and then click **OK**.

Sources List

All the sources on the Sources list were configured by an Administrator using the Web Manager software. From the Sources list, you can search sources, add a source to your favorites, double click on a source to open a full size view of the source and listen to audio for a source (if audio is enabled), and view your source groups. From the right-click menu, you can open a source, reset the decoder network stream for the source, and refresh the thumbnail for the source. You can also use this list to drag and drop sources to walls. Sources are shared by all users.



If the Active Directory feature is enabled, sources are not visible on the list if you do not have permissions to the source.

Additionally, administrators can access the Web Manager to view the source profile, add a new source, delete a source, or edit a source.

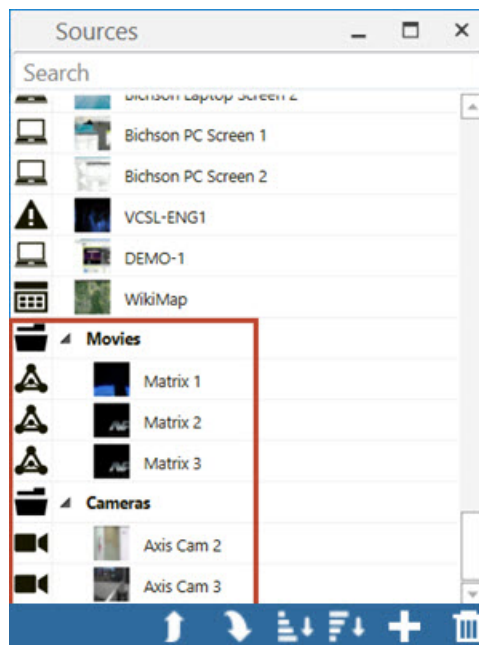
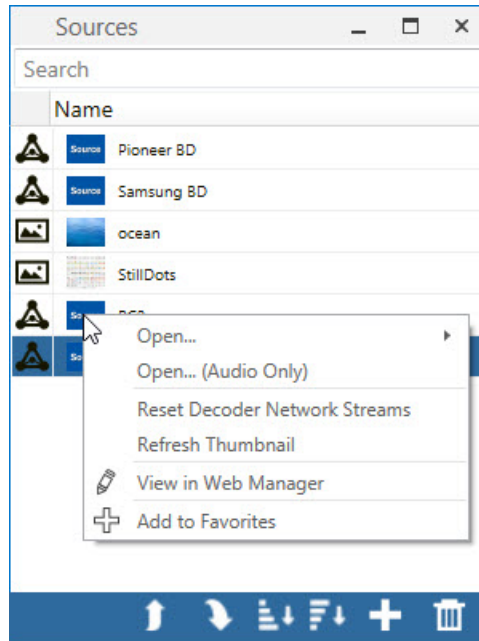

How to Open a Source

You can open a source in a wall simulator or on your desktop. When you open a source in a wall simulator, it is represented by a thumbnail in the wall simulator. When you open a source on your desktop, you view the source itself using the Desktop Client Source Viewer.

To open a source:

1. From the Sources list, do one of the following:



- To open the source in the wall simulator, right-click on it and click **Open**, click **In Simulator**, and then select the desired wall.
- To open the source on your desktop using the source viewer, double-click on the source; or right-click on it and click **Open**, and then click **On Desktop**.

How to Use the Source Viewer

The source viewer enables you to open and view a source on your desktop. Still sources are opened on your desktop using the default viewer associated with the file type for the source. For all other sources, the source is opened with the Desktop Client Source Viewer. The source viewer has a control bar that you can use as follows:

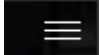

Click	To
	Stop the viewer.
	Restart the viewer.
	Listen to or mute audio for the source (if enabled). If audio is disabled for this source, the audio disabled icon () is displayed.
	Take and save a snapshot of the source.
	Display titles for the source.
	Add borders to the source.
	View the source in a scaled mode (default setting).
	View the source using its native resolution (with scroll bars).
	This mode provides better accuracy when using interaction mode.

Click	To
	Interact with a Remote Desktop source, VNC source, or a PC configured as a Phoenix DVI source on your desktop. When in this mode, the control bar is replaced by the interaction bar. The interaction bar is displayed on the top of the source window and an additional icon, the pushpin, is available. You can use the pushpin to pin the interaction bar so it is always displayed. Refer to <i>Interaction Mode</i> , page 176 for additional information on interaction mode.
	Pin the interaction bar to the desired location when using interaction mode. Click the pin again to unpin it.
	Minimize the source window, view the source full screen, or close the source window.
	Move the window.

Controlling PTZ (Pan/Tilt/Zoom) Cameras

RTSP sources that are ONVIF compatible have pan, tilt, and zoom capabilities. When you open an ONVIF compatible source or click on the source window, the PTZ controls are available.



To pan left or right, use the left and right controls on the source or the left and right arrow keys on your keyboard.



To tilt up or down, use the top and bottom controls on the source or the up and down arrow keys on your keyboard.



To zoom, use the + and - keys on your keyboard.



How to Reset the Decoder Network Streams

The Reset Decoder Network Streams option restarts the connection used to stream the video and audio from a source. If you are having issues with the source, reset the stream to attempt to resolve the issue.

To reset the stream:

1. From the Sources list, right-click on a source.
2. Click **Reset Decoder Network Streams**.

How to Refresh a Thumbnail

This option refreshes the thumbnail associated with the source. When you refresh the thumbnail, it is updated with the most recent capture of the source everywhere the source is represented in the Desktop Client



Keep in mind the thumbnail may also be set to refresh automatically if it has been configured with a Thumbnail Refresh Internal setting in the Web Manager.

To refresh the thumbnail:

1. From the Sources list, right-click on a source.
2. Click **Refresh Thumbnail**.

How to View a Source in the Web Manager

Administrators can view sources in the Web manager.

To view a source in the Web Manager:

1. From the Sources list, right-click on a source.
2. Click **View in Web Manager** to open the source in the Web Manager.

How to Add a Source to Favorites

You can add sources to a wall simulator from your list of favorites.



If the Active Directory feature is enabled, a favorite is not visible on the list if you do not have permissions to the source in the favorite.

To add a source to favorites:

1. From the Sources list, right-click on a source.
2. Click **Add to Favorites** to add the source to your favorites list.

How to Add a Message to a Source

Temporary text messages can be displayed on sources that are displayed on walls. To add a message to a source:

1. Drag a source onto the desired wall.
2. Right click on the source name on the Sources list and select **Display Message**.

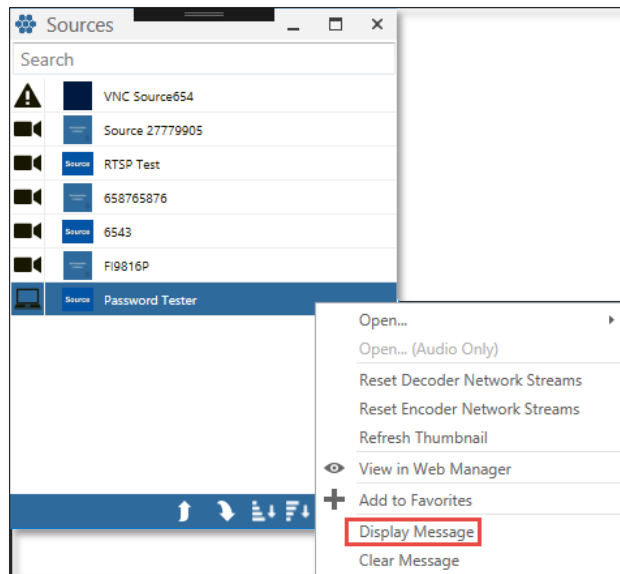

3. Type the message and format it using the formatting tools.

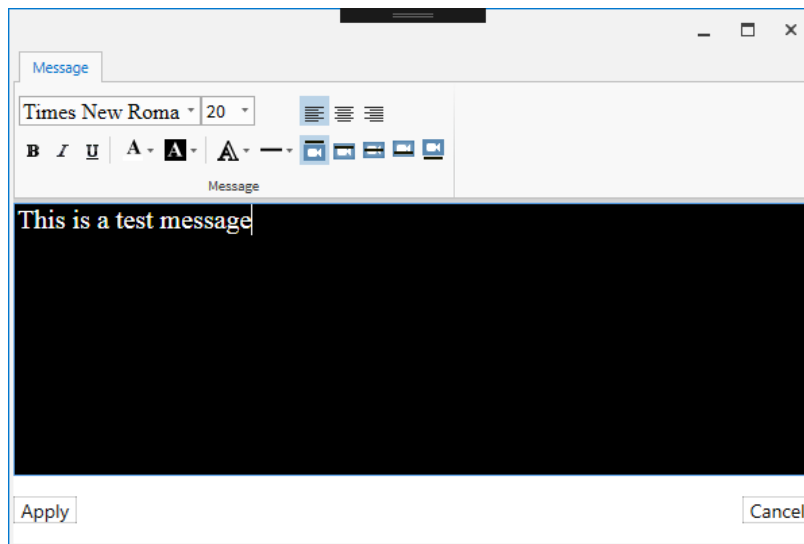

4. Click **Apply**.

How to Clear a Message from a Source

To clear a message from a source:

1. Right click on the source name on the Sources list and select **Clear Message**.

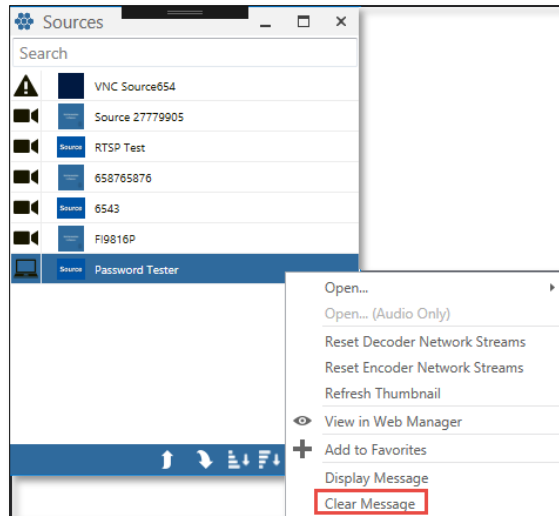

2. Respond to the confirmation message to clear the message.

How to Delete a Source Folder Groups

If you have created folder groups for sources, you can delete the folder group and all the sources in the group; or you can move the sources to a new group.

i Groups cannot be renamed.

To save the sources to a new group, select **Move items to a new group**, select a group from the drop down, and click **OK**.

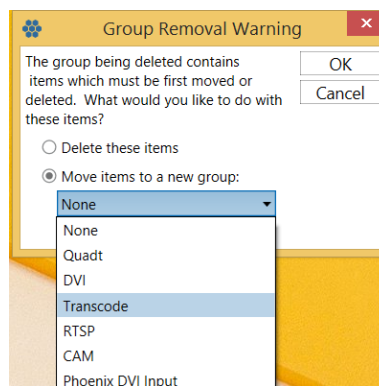

To delete the group and associated sources, select **Delete these items**, and then click **OK**.

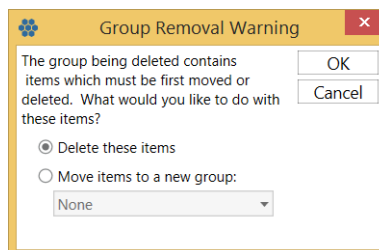

Walls List

From the Walls list, you can open a wall in a wall simulator, add a wall to your favorites list, or search your list of walls. Additionally, administrators can access the Web Manager to view the wall profile, add a new wall, or delete a wall.

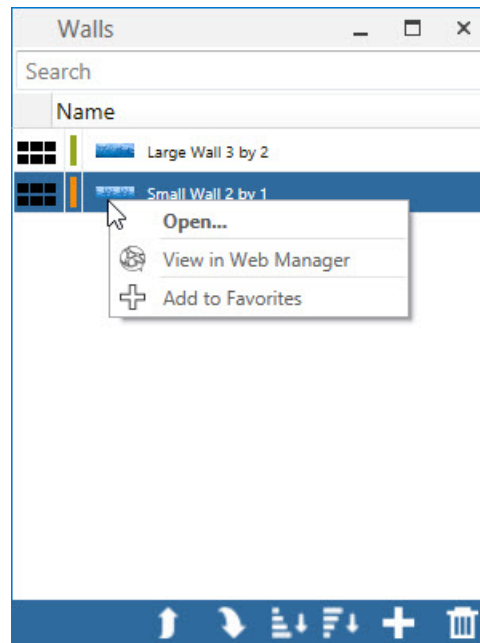

If the Active Directory feature is enabled, a wall not visible on the list if you do not have permissions to the wall.

When a wall is created, it is assigned a default color that is displayed next to the wall name in the wall list. This color helps you identify the wall that was used to create a wall layout.

Layouts List

From the Layouts list, you can apply a layout to a wall, rename a layout, search the list of layouts, add a layout to your favorites, add a new layout, and delete a layout.

When you design the content of a wall, you can save it as a wall layout. The wall layout preserves the wall content, position and size of the sources, and any treatments applied to the sources. Layouts help you quickly display a wall with a predefined format; or to change the appearance of a wall by applying a different layout to the wall.

Layouts are shared by all users and all walls managed by the same controller.

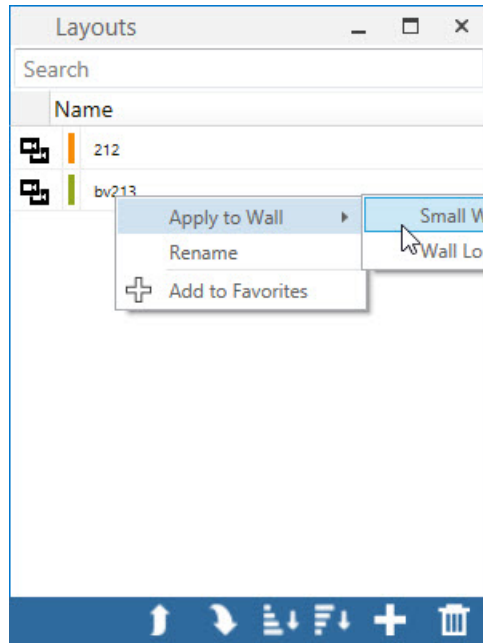

If the Active Directory feature is enabled, the layouts are not visible on the list if you do not have permissions to one or more sources in the layout.

The following illustrates the use of color to help you identify what wall was used to create each layout.

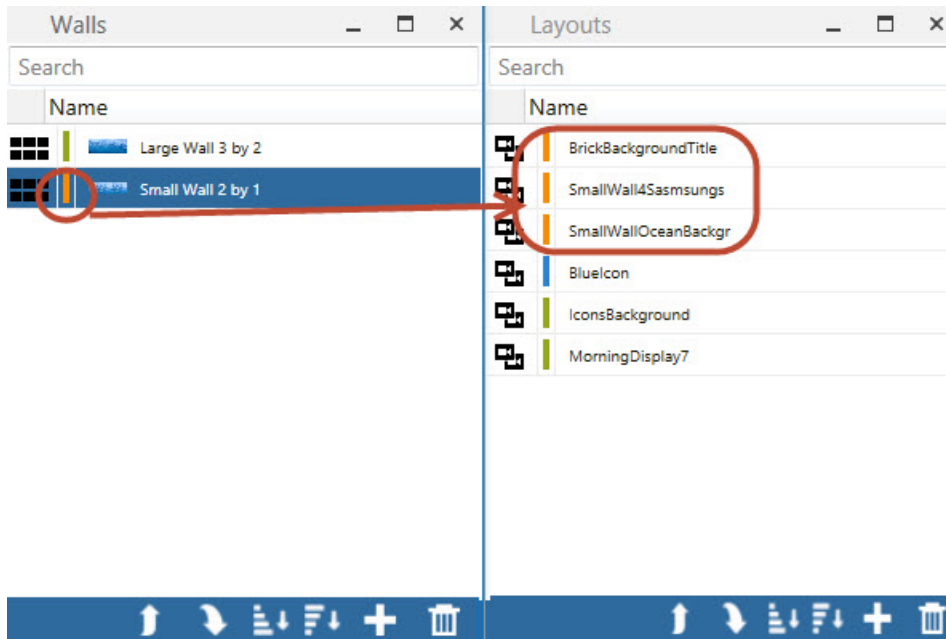

Layouts that are created on one wall can be applied to different walls. When you apply a layout to a different wall, you need to account for any size differences in the walls and the aspect ratio. For example, if you apply a layout that was created on a wall that is a different shape than the wall you are applying the layout to, you may need to change the layout to resolve the differences in the wall sizes.

From the Layouts list, you can create a layout for a wall, rename a layout, add a layout to your favorites list, delete a layout, apply an existing layout to another wall, and search layouts.

How to Create a Wall Layout

To create a wall layout:

1. From the Layouts list, click +.

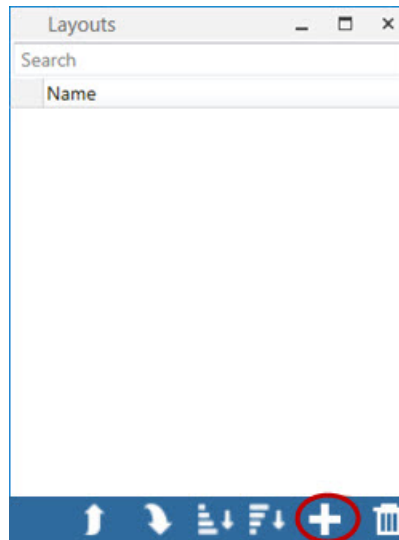

2. Click the name of the wall that you want to link with the current layout.
3. Type the name of the layout.
Optionally, type a name for a new Group or select a name from the dropdown list.

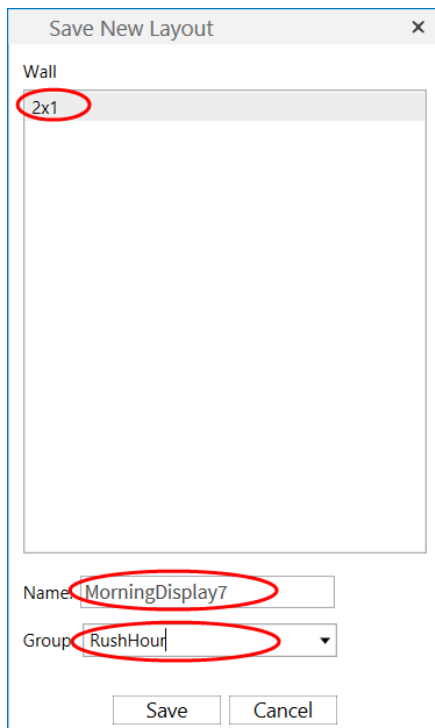

4. Click **Save**.

How to Delete Layout Folder Groups

If you have created folder groups for layouts, you can delete the folder group and all the layouts in the group; or you can move the layouts to a new group.

i Groups cannot be renamed.

To save the layouts to a new group, select **Move items to a new group**, select a group from the drop down, and click **OK**.

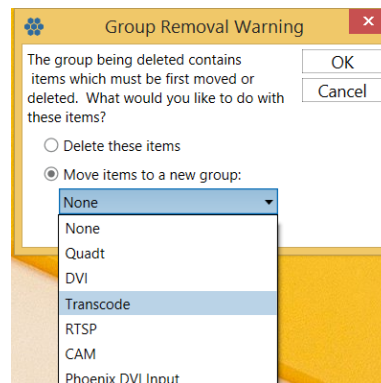

To delete the group and associated layouts, select **Delete these items**, and then click **OK**.

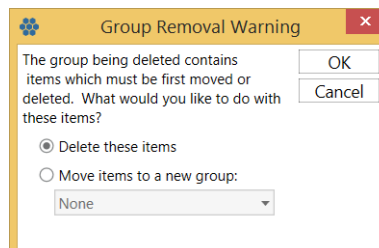

How to Rename a Layout

To rename a layout:

1. From the Layouts list, right-click on the name of the layout.
2. Click **Rename**.

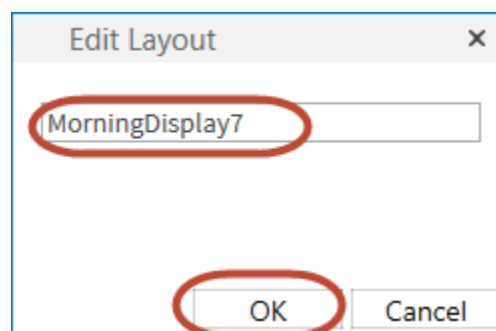

3. Type a new name.
4. Click OK.

How to Apply a Layout to another Wall

To apply a layout to another wall:

1. From the Layouts list, right-click on the name of the layout.
2. Click **Apply to Wall**, and then click the name of the wall you want to apply the layout to; or drag and drop a layout to a wall.



When you apply a layout to a wall and there is a problem with applying a source to the wall, you will receive a notification but the layout will still be applied. All other sources in the layout that can be applied will succeed.

Treatments List

Treatments define the properties of a source. The properties of a source include size, position, border, aspect ratio, crop, and pan and zoom. You can create treatments for sources by defining one or more of these properties. Additionally, you can apply more than one treatment to a source.



If you want to define more than one property, it might be helpful to define these properties in one treatment.

From the Treatments list, you can add a treatment to favorites, search for a treatment, or delete a treatment. All other tasks related to treatments are accessed through a source.

Treatments are shared by all users and all sources.

How to Create a Treatment

To create a treatment:

1. Right-click on a source on the wall simulator.
2. Click **Save As Treatment**.
3. Type the name of the treatment.
4. Select the desired options.
5. Click **OK**.

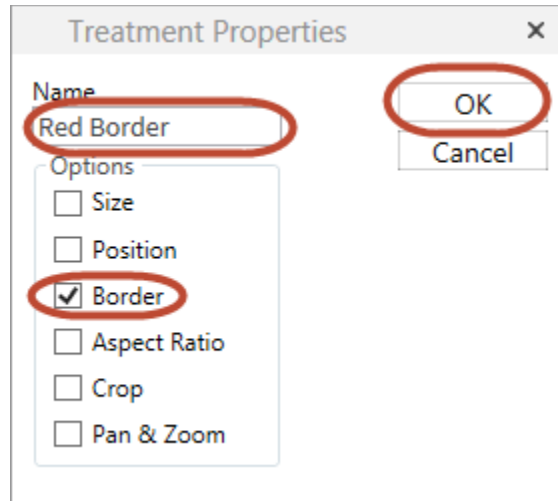

How to Apply a Treatment to a Source

To apply a treatment:

1. Right-click on a source.
2. Click **Apply Treatment**.
3. Click the name of the treatment you want to apply to the source.
4. Click **OK**.

i If drag and drop is enabled (refer to [How to Enable Desktop Drag and Drop](#), page 150), a treatment can also be dragged and dropped onto a source in the simulator.

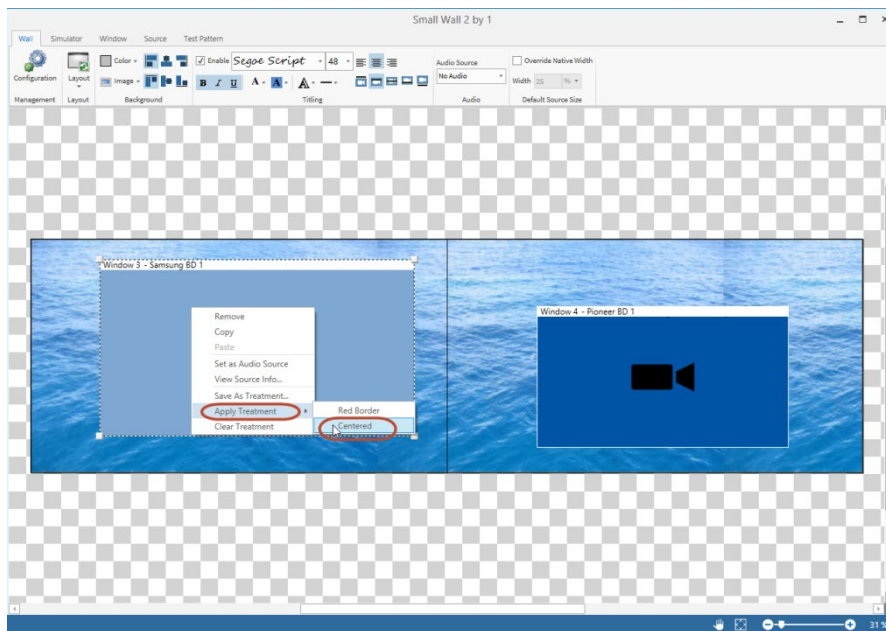

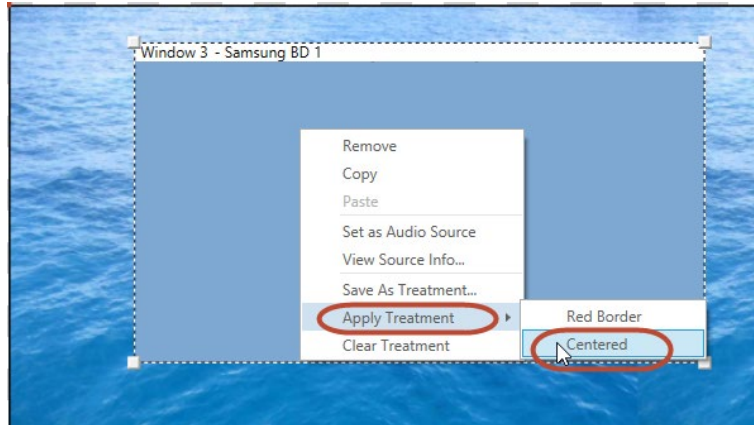

How to Clear a Source Treatment

To clear all of the treatments applied to a source:

1. Right-click on the source.
2. Click **Clear Treatment**.

Favorites List

You can create a personalized list of favorite sources, wall simulators, layouts, and treatments. The list of favorites is arranged by the date and time the favorite was added. The oldest item appears at the top of the list.

Favorites are not shared by other users. All users can create their own list of favorites.



If the Active Directory feature is enabled, a favorite is not visible on a list if you do not have permissions to the item in the favorite.

How to Add an Item to Favorites

To add an item to your list of favorites:

1. Right-click on the item.
2. Click **Add to Favorites**.

Users List

From this list you can view a list of users and you can use instant messaging to communicate with other active users. On the list of users, users that are currently logged in have a blue online status indicator.

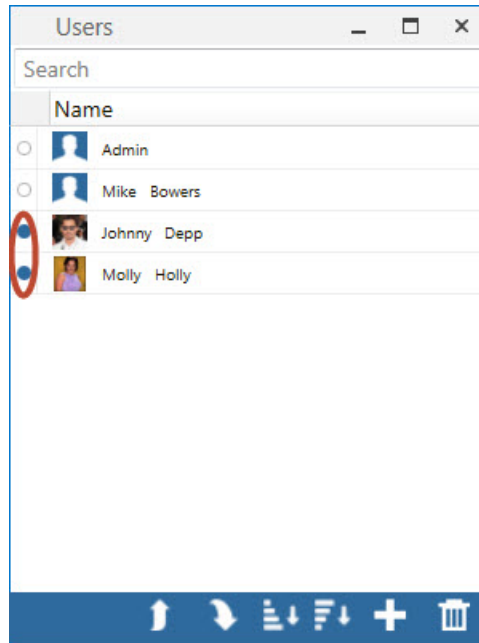

Additionally, administrators can delete a user or access the Web Manager to add a new user.



When you are logged in, your user name is not displayed on your list of users, but you appear as an active users to other active users.

How to Manage Users

- To add a new user, click on the + icon, and then refer to *How to Add a User*, page 107.
- To delete a user, click on the trash can icon, and then refer to *How to Delete a User*, page 112.
- To send an instant message or send a source to an active user, double-click the user’s name, enter your message, (optionally) attach a source, and click **Send**.

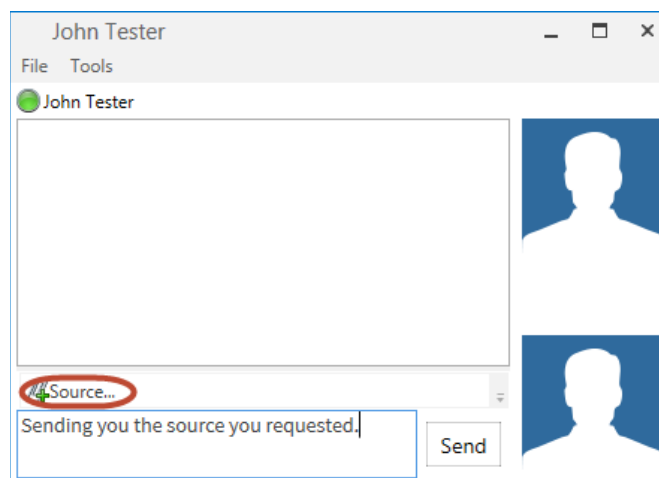

Wall Simulator

When you double-click a wall name, the wall opens in the wall simulator. You use the wall simulator to design the content for the wall and the format of the content. The wall simulator has a ribbon interface that you use to design the content and appearance of a wall. In the simulator, you have access to the following tabs and associated commands:

- Wall
- Simulator
- Window
- Source
- Test Pattern



If you do not have permissions to a source, it is displayed on the wall simulator with a lock icon. The source is restricted and it cannot be modified or removed by users without permissions.

Working with Subwalls

The following summarizes the differences between working with walls and subwalls:

When working on subwalls, the only sources you can manipulate are the sources that are completely contained in the subwall. Any sources that are shared with another subwall will not be visible in the wall simulator; they are only visible on the wall displays.

When working with subwalls, you cannot move a source outside of the border of the wall simulator. In the following illustration, sources cannot be moved outside the blue rectangular.

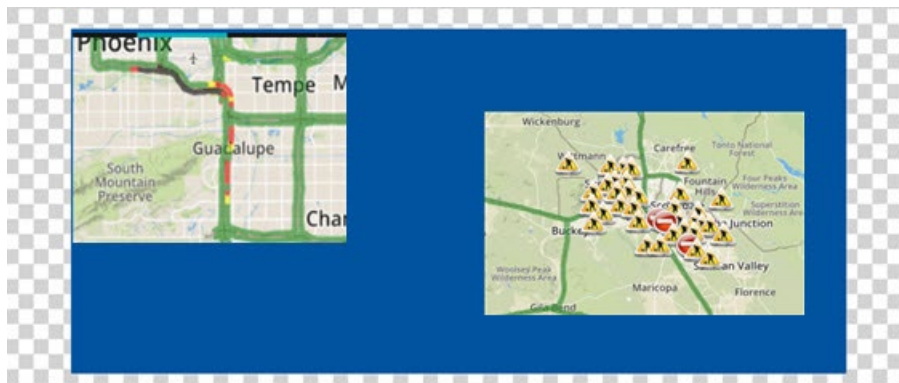

How to Add a Source to a Wall

To add a source to a wall:

1. Double-click on a wall name in the Walls list. The wall opens in the wall simulator.
2. Do one of the following:
 - a. From the Sources list, drag and drop sources on the wall.



If you drag and drop a source on top of an existing source, it will replace the source.

- b. Right-click in the wall simulator and select Add Source, and then point to the desired source, and then click on the source name.



The minimum size of any source for a wall is 64x64 pixels.

How to Remove a Source from a Wall

To remove a source from a wall:

1. Double-click on a wall name in the Walls list. The wall opens in the wall simulator.
2. Click on the source you want to remove, and then right-click and select **Remove**.

How to View a Source on your Desktop

To view a source that is on a wall simulator on your desktop:

1. Right-click on the source in the wall simulator window.
2. Select **Show on Desktop**. The source opens on your desktop.

Wall Tab

The Wall tab has options for management, layouts, backgrounds, titling, audio, and default source size.



The minimum size of any source for a wall is 64x64 pixels.

Wall

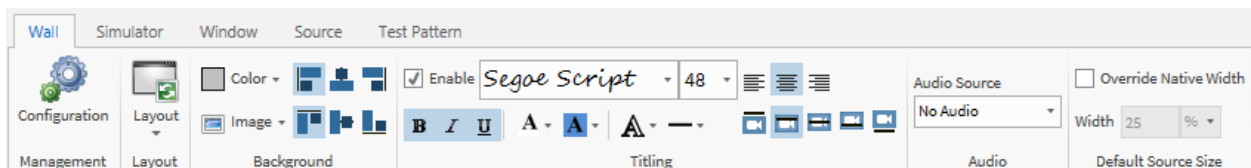

Management

The Configuration option in the Management group is used by administrators to access the Web manager to view the wall profile, edit the profile, add test patterns to the wall, or access other options in the Web Manager.

Layout

This option is used to edit the name of a layout (pencil icon), delete a layout, update a layout, or add a new layout.

Background

This group is used to set the background color for the wall, select an image for the background of the wall, and select the display mode for the background image.

Titling

This group is used to enable or disable titling for the sources on the wall. When enabled, you can change the font and format. To display the source titles in the simulator, Show Titles must be checked in the Simulator tab.



Source titles are set and can be modified using the Web Manager.

Audio

This option is used to specify the audio source for the wall. Valid audio sources are sources on the wall that are configured with audio allowed in the Web Manager.



Only one source on a wall can be selected to play the audio for the wall; but the source can be changed at any time.

Default Source Size

This group enables or disables the option to override the default width of the source. If enabled, specify the width in pixels or a percentage relative to the size of the wall.

How to Add a Layout to a Group

To add an existing layout to a group:

1. Using the Desktop Client, open a wall.
2. From the Layout option on the Wall tab, select the layout you want to add to a group.
3. From the Layout tab, select **Update Layout**.
4. In the Group field, type the name of a group you want to create or select an existing group name from the dropdown list.

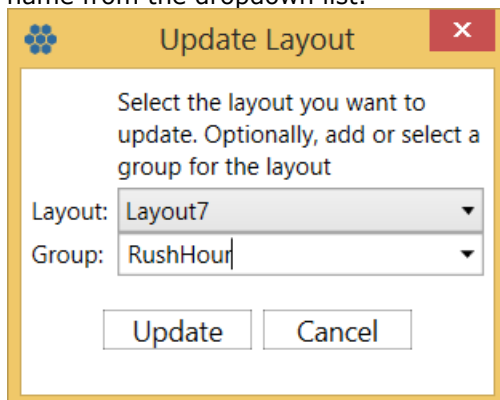

5. Click **Update**.

How to Edit a Wall in Preview Mode

The **Open in Preview** mode enables you to edit walls in an offline mode. The changes are not updated on the wall until you request the wall be updated.

To work in the offline mode:

1. Download the latest Desktop Client, version 1.6.0 or later.
2. Open the walls list.
3. Right click on the wall you want to update and click **Open in Preview**.

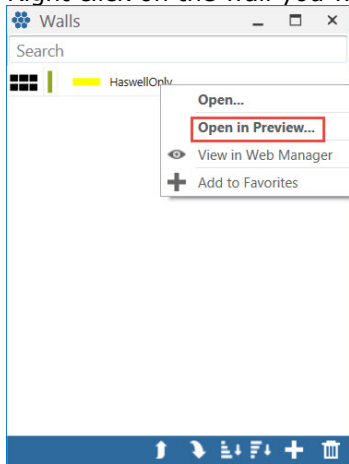

The title bar of the wall simulator has the editing icon ().

4. Make the desired changes.

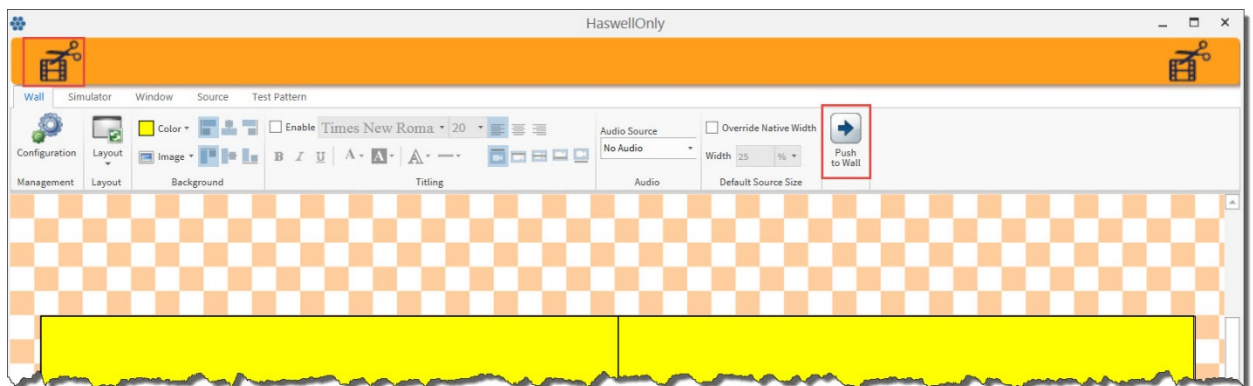

5. When you want to update the wall, click **Push to Wall**.

Simulator Tab

The Simulator tab has options for management, overlays, and snapping.

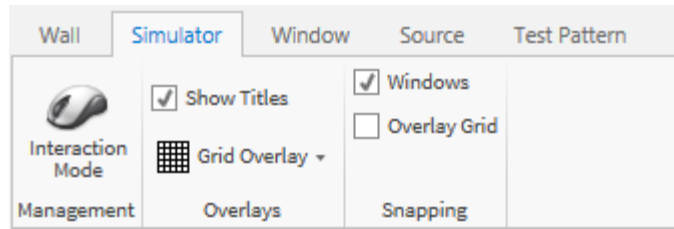

Interaction Mode (Management)

This option enables you to directly interact with a Remote Desktop source, a VNC source, or a Phoenix DVI Input source on a wall using Interaction Mode.

i To interact with a Phoenix DVI Input source, additional cabling is required. Refer to [How to Connect Cabling for Interaction Mode for a HID-Capable Device](#), page 20.

When the interaction mode is enabled, the simulator is unavailable.

- To enable it, click **Interaction Mode**.
- To disable the Interaction Mode click on **Interaction Mode**.

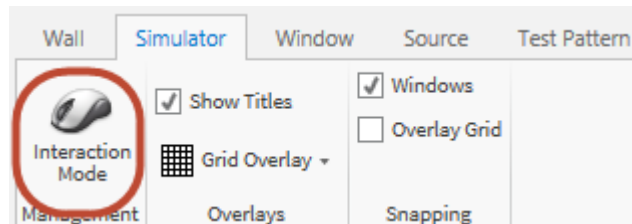

i Interaction with the source will not be permitted, if the source is not set to allow interaction. Allowing interaction with a source is set using the Allow Interaction check box on the Add Source or Edit Source page (refer to [How to Add a Source](#), page 54 or [How to Edit a Source](#), page 78).

When interaction mode is enabled, you can still interact with the wall even if no sources have interaction allowed. Through interaction with the wall, you can move, resize, and remove sources. This is done using the window frame (the title, minimize, maximize, and close buttons) that appears around all the sources on the actual wall, not on the wall simulator.

Overlays

This group is used to show titles in the format defined on the Wall tab if titling is enabled. The title is set in the Source Profile in the Web Manager. Additionally, you can define the format and placement of the grid overlay. The grid overlay can be based on the outputs on the wall or a custom design.

Snapping

This group is used to select the check box to enable snapping to a window or to the grid overlay. When snapping is enabled, once the sources are 25 pixels or less apart from each other or from the grid, they will snap together or to the grid (depending if you have enabled snapping to windows or the grid).

Window Tab

The Window tab has options for position, transform, alignment, placement, spacing, Z-order, and borders. Use these options to position sources on the wall in specified formats.

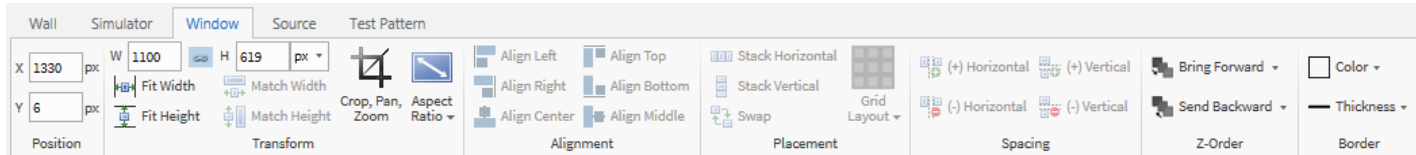

Position

This group is used to modify the position of the selected source on the wall simulator using the X and Y coordinates.

Transform

This group is used to change the size of selected windows to fit the width or height of the wall; set the size of selected windows to be the same width or height (requires more than one window to be selected); crop, pan, or zoom a source; or modify or reset the aspect ratio of a source.



If the Fit Width or Fit Height option is selected, the aspect ratio will be maintained but the source may not fit properly on the wall simulator.

Alignment

This group is used to modify the alignment of the sources on the wall.

Placement

This group is used to modify the placement of the sources relative to each other on the wall (requires more than one window to be selected).

Spacing

This group is used to increase or decrease the spacing between two or more sources.

Z-Order

This group is used to modify the order of sources on the wall. To bring a source to the front of the wall, click **Bring to Front**. To bring a source one layer towards the front of the wall, click **Bring Forward**. To send source to the back of the wall, click **Send to Back**. To send a source one layer toward the back, click **Send Backward**.

Border

This group is used to add borders using the specified color and thickness to the selected source.

Source Tab

The Source tab has options for identity and management.

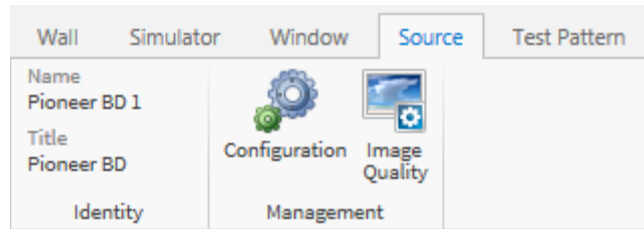

Identity

This group displays the source name and source title of the selected source.

Management

For administrators, the Configuration option opens the source in the Web Manager. The Image Quality option is used to modify hue, contrast, saturation, brightness, and gamma for the selected source.

Test Pattern Tab

The Test Pattern tab has options for pattern types, pattern options, and grip options.

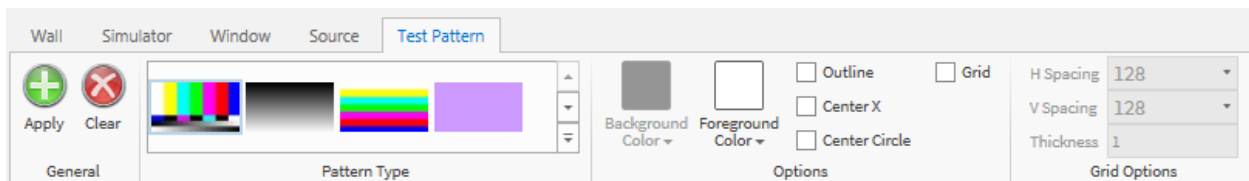

The test patterns are applied to walls to visually test the display for problems.

General

This group is used to apply or clear the test pattern. To apply a pattern, select the desired pattern type and click **Apply**. To remove the test pattern, click **Clear**.

Pattern Type

This group is used to specify the pattern (e.g. color bars horizontally or vertically) for the test pattern.

Options

This group is used to specify the foreground and background color, test pattern overlay options, and turns on and off grid.

Grid Options

This group is used to specify the spacing and thickness for the grip, if Grid is selected.

Change the Controller

If you have more than one controller, you can select a different system to interact with by clicking **Change Controller** on the main menu.

i You must log out when the controller is changed.

Using Workspaces and Settings

Workspaces save the PC work area including the open Desktop Client lists and their placement in the work area for individual users.

i Workspaces are saved per controller. If you connect to more than one controller, you need to save workspaces for each controller.

The popup that is accessed by right-clicking the Desktop Client icon enables you to save your current desktop workspace, open a saved workspace, manage (delete or rename) a workspace, show all windows, close all windows, change the settings, or exit from the Desktop Client.

Workspaces are not shared with other users. They are private and saved with your user profile locally on the PC you created them on.

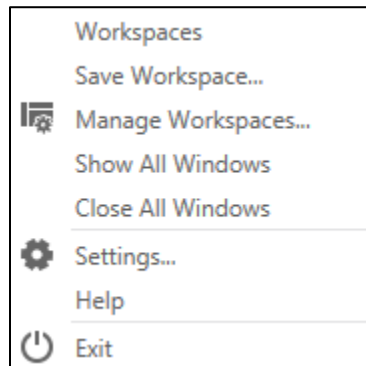

How to Save a Desktop Workspace

If you have arranged your desktop workspace to a setup you would like to reuse, you can save the setup for future use. You can save different workspaces with different arrangements.

To save a desktop workspace:

1. Right-click on the Desktop Client icon (🌸).
2. Click **Save Workspace**.
3. Type a name for the workspace.
4. Click **OK**.

How to Open a Saved Workspace

To open a saved Workspace:

1. Right-click on the Desktop Client icon ()
2. Click **Workspaces**, and then select the desired work space from the list.

Changing the Settings

Refer to *Phoenix Desktop Client Settings*, page 149.

Configure Audio for a Wall

Equipment needed: 3.5 mm audio cables and speaker

Wall audio is available through all of the audio-enabled decoding sources on the wall; but you can only listen to one audio source. The audio source for the wall can be changed at any time.

On the Phoenix node, two input audio channels are supported using the blue In A (audio in) or the pink In B (audio in) connector, and one output channel is supported using the green Line Out (audio out) connector.



To use audio from a source that is connected to the network (not through the Input A or B connectors), the source must have audio supported and does not require additional cabling.

To configure audio for a wall for a source connected to Input A or Input B:

1. Create a source with audio enabled (refer to [How to Add a Source](#), page 54).
2. Verify the audio is enabled on the source (e.g., If it is a PC playing a video, verify that you can hear the audio from the PC).
3. Connect the DVI cable from the source to the **In A** or **In B** connector on the encoder node.
4. Connect the audio cables as follows:
 - a. At the device generating the audio, connect the output cable to the green audio out connector. This is referred to as the audio input cable.
 - b. At any Phoenix decoder node associated with the wall, connect the audio out cable connected to the speaker for the wall to the green Line Out connector.
 - c. At the encoder Phoenix node that is connected to the DVI cable from step 3, do one of the following:
 - If the DVI cable associated with the source is connected to **Input A**, connect the audio input cable to the blue **In A** connector.
 - If the DVI cable associated with the source is connected to **Input B**, connect the audio input cable to the pink **In B**.



Verify that the speaker is powered on and the volume is adjusted.

5. Add the source (from step 3) to the wall (refer to [Simulator](#), page 168).
6. Enable audio for the source in the wall simulator by right-clicking on the source and selecting **Set as Audio Source**.

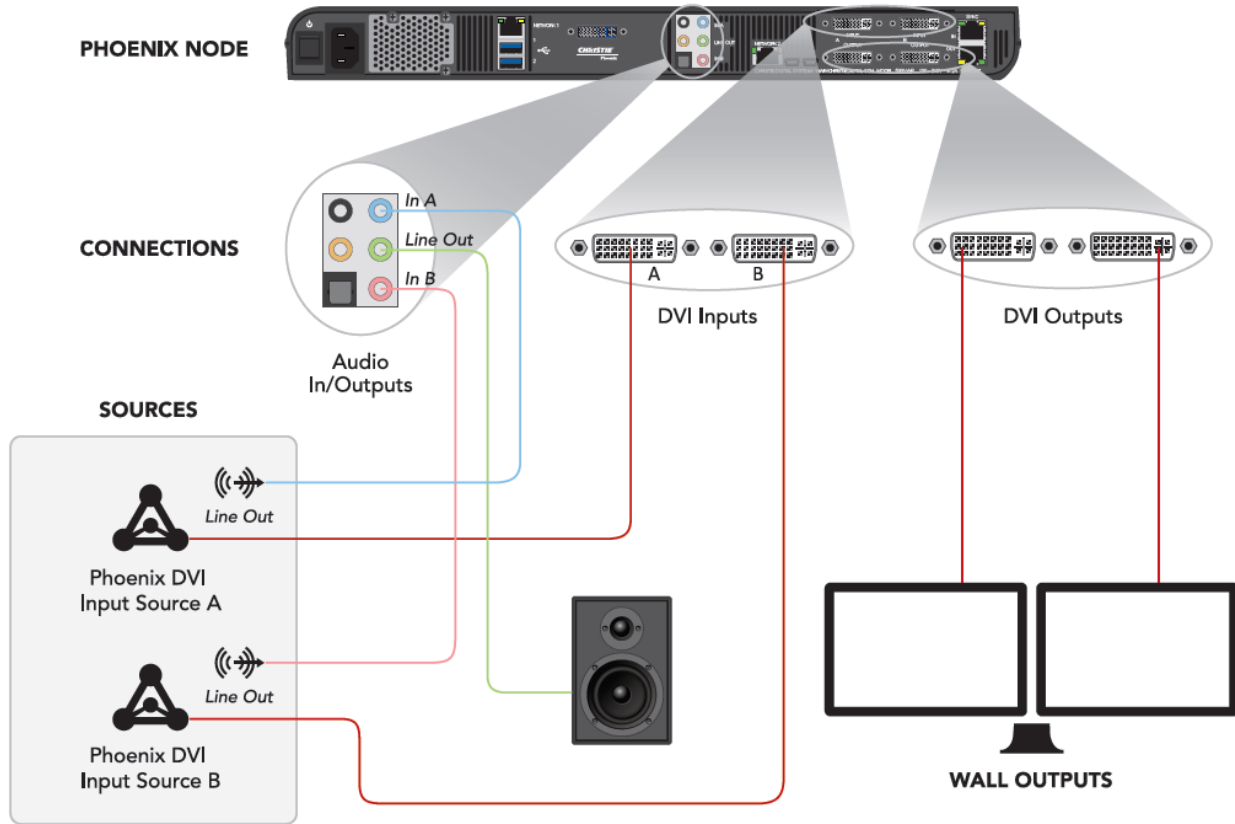

Figure 28 – Audio Connections

Interaction Mode

You can interact with a wall using one of the following methods:

- Desktop Client Interaction (refer to [Interaction using Desktop Client](#), page 177). This option allows the user to interact with the display wall by using the wall simulator in the Desktop Client software.
- Direct Interaction (refer to [Direct Interaction](#), page 177). This option uses a mouse and optional keyboard connected directly to a node serving as a decoder for the wall.

When interacting with a wall, you can change the content on a wall, the layout of a wall, or interact directly with a source. Using the cursor on the wall you can move or resize sources, or remove a source from the wall by interacting with the window frame, the title bar, and close button on the wall.

i To interact with the wall, you need to be able to see the wall to control the cursor.

To interact with a source, it must support interaction. To verify this, view the source profile using the Web Manager and verify the USB icon is displayed next to the Capabilities Allowed field. If it is not, edit the source to enable interaction. See the following example.

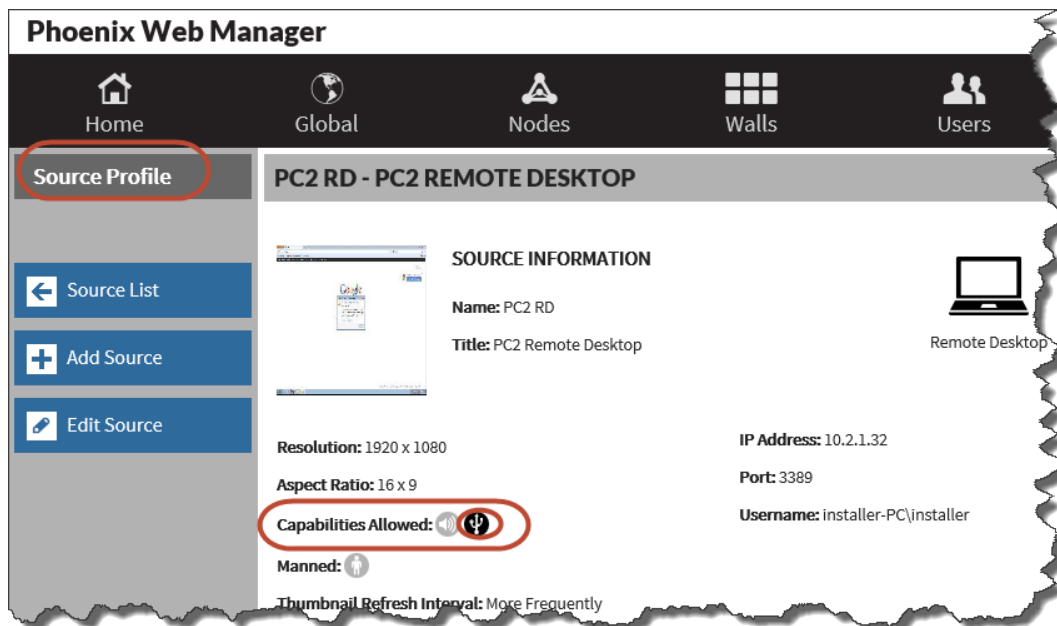

When interacting with a Remote Desktop, VNC, or a HID-capable device configured as a Phoenix DVI Input source on a wall, you can interact with the source and perform the same tasks you would at the source. For example, if the source is a PC running a browser, you could use Google to perform a search.

i To interact with a HID-capable device configured as a Phoenix DVI source, additional cabling is required (refer to [How to Connect Cabling for Interaction Mode for a HID-Capable Device](#), page 34).



In interaction mode, you can use quick keys (for example, mute/unmute), two quick buttons to send Ctrl+Alt+Del to the source, and the Windows key (labeled with a **Windows** logo); but you cannot use Windows shortcut keys (e.g. Ctrl + A) in interaction mode.

Before using this feature, review your settings for the following on the Global settings page:

- Wall Cursor Size
- Display Wall Mouse Timeout
- Display Mouse vs. KVM Layers

Direct Interaction

To interact with a wall through a node, you need to connect a mouse and optionally a keyboard to a Phoenix node that has a display for the wall connected to the Output A or B connector (the node is performing the decoding role). Additionally, you need to connect the HID-capable source that has been configured as a Phoenix DVI Input source to the node encoding the source. This connection uses one of the KVM connectors on the node. No additional software is required. When in interaction mode, use the speaker icon to turn audio on or off for the source.



To enable this feature, please contact customer support.

Interaction using Desktop Client

To interact with a wall using the Desktop Client, use the Interaction Mode on the Simulator Tab.

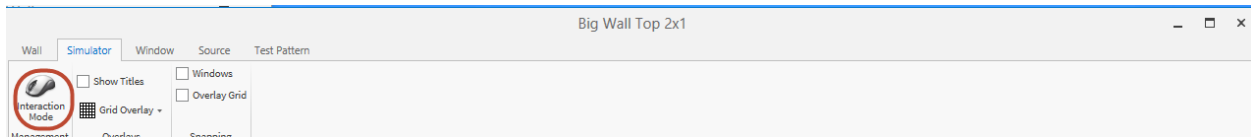

When interacting with a wall through the Desktop Client, the wall simulator is temporarily disabled, the cursor is displayed on the wall, and the mouse and speaker icons are displayed on each source on the wall. When interaction mode is enabled, the mouse icon is highlighted with green. In the following example, interaction is enabled for the source on the right with the cursor displayed) and not the other source. When in interaction mode, use the speaker icon to turn audio on or off for the source. Audio is on for the source on the right.

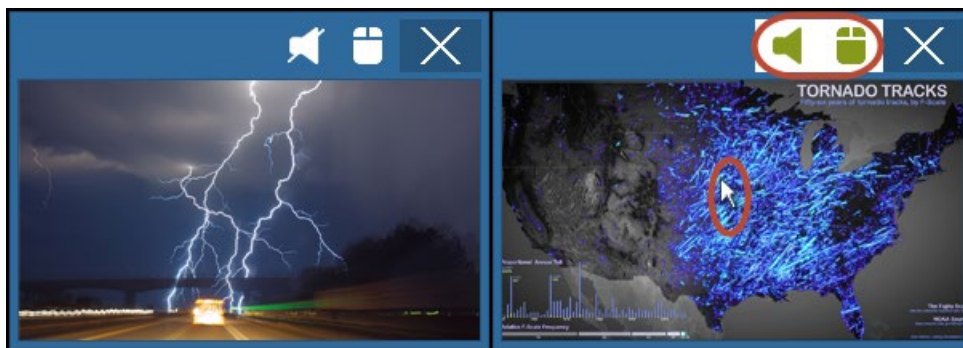

Periodic Maintenance

This section contains information on tasks that you should perform to maintain your system.



The Phoenix system does not have any user-serviceable internal parts. Therefore, for issues not covered in this document, or if you are having problems with your system, contact the support center.

Maintenance Schedule

The following are items that should be checked by an administrator:

Table 18 — Recommended Maintenance

Task	Schedule	Reference
Perform a identify node LED test.	During installation and every 6 months	How to Edit a Node , page 87
View the source and node status and resolve any problems.	Daily	Manage Nodes , page 81
Update system.	When advised	Update the System , page 116
Remove any accumulated dust at the rear panel slots while the unit fans are running.	Periodically	None

Glossary

Term	Description
AAC	Advanced Audio Coding. One of the audio encoding defaults for the Phoenix system.
Alerts	An event that has reached a level that caused an alert for the event.
Bezel Compensation	A setting to compensate for the width of a bezel around a display when sources are displayed across two displays.
Bitrate	The rate that data is transmitted in a given amount of time.
Controller	A node that manages the system data and status for all the nodes on the network.
Decoder	A node that decodes sources.
decoding	Process of transferring video streams or other data from one format to another. For the Phoenix system, this typically refers to converting network video streams into a viewable image that is composited and displayed on the Phoenix DVI outputs.
DNS	Domain Name System.
EDID	Extended Display Identification Data.
Encoder	A node that encodes sources.
Encoding	Process of transferring video streams or other data from one format to another. For the Phoenix system, this typically refers to converting DVI video signals or external network streams from Remote Desktop or VNC sources into a H.264 network stream.
GenLock	A technique used to synchronize the video output of one source to other sources.
H.264	ITU-T standard for advanced video coding for generic audiovisual services.
HDMI	High-Definition Multimedia Interface
HID	Human Interaction Device.
HTTP	Hypertext Transfer Protocol.
IGMP	Internet Group Management Protocol.
IPv4	Internet Protocol version 4 (IPv4) is the fourth version of the Internet Protocol.
KVM	Keyboard, Video, Mouse.
LAN	Local Area Network.
LMHOSTS	The LAN Manager Hosts file is used to enable domain name resolution under Windows when other methods, such as WINS, fail.
Mapped output	Number of outputs that are physically connected to an output port and configured on the wall.
MPEG	Moving Picture Experts Group. One of the audio encoding defaults for the Phoenix system.
Multicast	The delivery of a message or information to a group of destination computers simultaneously in a single transmission from the source.
Node	The physical Phoenix system unit.

Term	Description
Node ID	The ID assigned for the node during manufacturing (format: serial number).
Node Mapping	The arrangement of nodes used for a wall layout.
Node Role	The type of task (decoder, encoder, and controller) a node performs.
Output array	The arrangement of the displays for a wall specified by the number of displays in the width and height (e.g., 2x3).
PCMU	Post Code Modulation mu-law. One of the audio encoding defaults.
PIM	Protocol Independent Multicast. A protocol used for IGMP.
RDP	Remote Desktop Protocol. A source type for the Phoenix system.
Reduced blanking	Used to reduce the blanking time of drawing a screen image. The blanking time is the time spent on other tasks rather than drawing the image. An output format setting for walls in the Web Manager.
Refresh rate	The number of times per second that a display refreshes the data, measured in Hz.
RTP	Real Time Protocol. A network protocol supported by the Phoenix system.
RTSP	Real Time Streaming Protocol. A source type for the Phoenix system.
SM	Sparse Mode. A mode used for IGMP.
SRTP	The Secure Real-time Transport Protocol. A network protocol supported by the Phoenix system.
TCP	Transmission Control Protocol. A network protocol supported by the Phoenix system.
Transcoding	Process of transferring video streams or other data from one format to another.
UDP	User Datagram Protocol (used for video). A protocol supported by the Phoenix system.
Unicast	Communication between a single sender and a single receiver over a network.
Unmapped output	The outputs that are physically connected to an output port but have not been assigned to a wall.
User Role	The role (user or administrator) a user is assigned to for security purposes.
VESA	Video Electronics Standards Association. An international standards body for computer graphics.
VNC	Virtual Network Connection. A source type for the Phoenix system.
WCF	Windows Communication Foundation.
WINS	Windows Internet Name Service.

Appendix A - Ports used by the Phoenix System

The following ports may be used by the Phoenix system. Make sure they are not blocked in your network.

Port	Service	Type	Description
Various	RTP Manufacturer specific	UDP (Unicast or Multicast)	RTP traffic from IP cameras and other streaming sources may use many different ports.
80	HTTP	TCP	Used for the Phoenix Web Interface.
123	NTP Network Time Protocol	UDP	Used for time synchronization.
554	RTSP	TCP	RTSP is a network control protocol used for establishing and controlling media sessions between the controller and the source. Required by a Phoenix node to subscribe to a source.
636	LDAPS	TCP	Query of LDAP server over encrypted connections.
3389	RDP	TCP	The default Remote Desktop Protocol port is 3389. A new port can be assigned for use from VNC and Phoenix.
3702	ONVIF camera discovery	UDP (Multicast)	Discovery of IP camera addresses using ONVIF-compliant IP cameras.
5900 Sequential ports per screen	VNC	TCP	The default TightVNC port is 5900. A new port can be assigned for use from VNC and Phoenix.
10000	Phoenix Node Discovery	UDP (Multicast)	Phoenix uses a proprietary discovery network for node discovery and delivering configuration instructions.
11123	Phoenix Communication	TCP	A Phoenix system uses this port for a variety of services including: <ul style="list-style-type: none"> • Node to Node communication • Node to Desktop Client communication • Firmware updates • Still image files
11135	External Control Server	TCP	ASCII-based application protocol interface – API used by 3rd party control systems.
23456	JSON API	TCP	Phoenix Application Programming Interface.
32000	Phoenix Controller Keep Alive	UDP (Multicast)	Used to send messages (keep alive) between the redundant controller and the primary controller.
49,152 to 65,535 Dynamically allocated	RTP Phoenix streaming traffic	UDP (Multicast)	The RTP port defines a standardized packet format for delivering audio and video over IP networks. Required for transport of content between Phoenix nodes. Ports are assigned dynamically as required.
49,152 to 65,535 Dynamically allocated	SRTP	UDP	Encrypted RTP streaming.

Appendix B – Phoenix System Specifications

Phoenix Node		Network Streaming Appliance
Chassis		1U form factor
		Included mounting brackets (ears)
		Optional under table mount
		Optional VESA "sandwich" mount
Outputs	Dual DL-DVI (digital only)	For hardware version 3 and later: Up to 1920x1200 resolution per output (nodes using this resolution should be configured for decoding only). For hardware versions 1 and 2: Up to 2560x1600 resolution per output.
		Support for bezel compensation.
		Support for display overlap.
		Support for custom resolutions.
Inputs	DVI (digital only)	The following standard resolutions are supported for sources that are encoded by a Phoenix node: 640x350, 640x400, 640x480, 720x400, 720x480, 720x486, 720x576, 768x576, 800x480, 800x600, 848x480, 852x480, 960x540, 1024x576, 1024x600, 1024x768, 1152x768, 1152x864, 1280x720, 1280x768, 1280x800, 1280x854, 1280x960, 1280x1024, 1280x1600, 1344x756, 1344x1008, 1360x768, 1360x1024, 1366x768, 1366x1024, 1400x1050, 1440x240, 1440x1050, 1440x900, 1440x960, 1440x1080, 1600x900, 1600x1200, 1680x1050, 1920x540, 1920x1080, 1920x1200
	Dual 3.5 mm stereo audio	Analog stereo audio encoded to AAC.
	Dual mini-USB	HID device emulation for KVM control of Phoenix DVI inputs.
Network	Dual Gigabit Ethernet	1000 Mbps Ethernet, RJ45 connectors Support for IGMPv2, IPv4, RTSP, SRTP, HTTP, TCP/IP, RTP, and UDP. Support for ONVIF camera discovery and ONVIF PTZ camera control.
Control		Ethernet Serial RS-232 (available only on 120-059105-02 units)
Encoding		2 high definition DVI inputs to L5 H.264 video streams at 30 FPS.
		2 stereo audio streams
		Support for variable bitrate
Decoding		A combination of 12 H.264 and MPEG-2 network video streams @ 30Hz
		Includes borders and labeling
		Up to 20Mbps per video stream
		Direct support for network cameras
Transcoding		VNC and RDP streams transcoded to H.264
Physical Specifications		Size: (W x H x D) 17.40" x 1.74" x 9.5" (442x44x241mm)

		Weight: 6.5lbs. (2.95kg)
Power		100-240VAC 50-60Hz (auto-ranging power supply)
		4-2A (max)
		220W (max)
		750 BTU/hr (max)
Sound pressure (operator position)		0.5m distance, device on tabletop is 40.7 dBA max
Reliability	MTBF	>50,000 hours of major modules
	MTTR	<15 minutes
Regulatory safety	<ul style="list-style-type: none"> • CAN/CSA C22.2 No. 60950-1 • UL 60950-1 • IEC 60065 (ed.7); IEC 60065 (ed.7) am1-am2 • IEC 60950-1 FCC CFR47, Part 15, Subpart B, Class A –unintentional radiators • EN55103-1 Class A audio, video, audio-visual equipment emission; EN55103-2 audio video, audio-visual equipment immunity; EN61000-3-2, EN61000-3-3 • Directives: (EC) 2011/65/EU (RoHS); 2012/19/EU (WEEE); Regulation (EC) No. 1907/2006 (REACH) • Certification marks: check with Christie for the latest update. 	
Manufacturing location	Designed, manufactured and tested by Christie Digital Systems Inc.'s facility in Phoenix, Arizona, USA.	
Warranty	<ul style="list-style-type: none"> • Limited two years parts and labor. 	

Appendix C - Qualified Christie Video Wall Panels for Phoenix EP

Phoenix EP is compatible with select, qualified Christie video wall panels including FHD -XV and -XE models introduced in 2016 and 2017. Consult your Christie representative to verify compatibility.

VNC Sources						
Source Name	Password	Display Index	IP Address	Port		
Application Sources						
Source Name	URL	Command				
Walls						
Wall Name	Output Array	Format	Synchronization Enabled	Outputs	Nodes	Audio

Appendix E – Tips

This section contains some useful tips about the Phoenix system.

Quick Facts

Here are some quick facts about the Phoenix system:

- A node can perform more than one role; it can be a controller, decoder, and encoder.
- When the nodes are on the same network, they interact with one controller. All nodes in one Phoenix system have to be on the same VLAN.
- A controller manages up to 64 nodes.
- A wall supports up to 128 outputs.
- A wall can display 12 sources on a single decoder’s output.
- Sources are shared between all nodes.
- The Phoenix system has three user interfaces: Controller Manager, Web Manager, and Desktop Client.

Change the Cursor Shape for VNC Sources

The default setting for the cursor shape for VNC sources is a small dot. To change the cursor to an arrow for TightVNC:

1. Launch TightVNC.
2. Click **Options**.

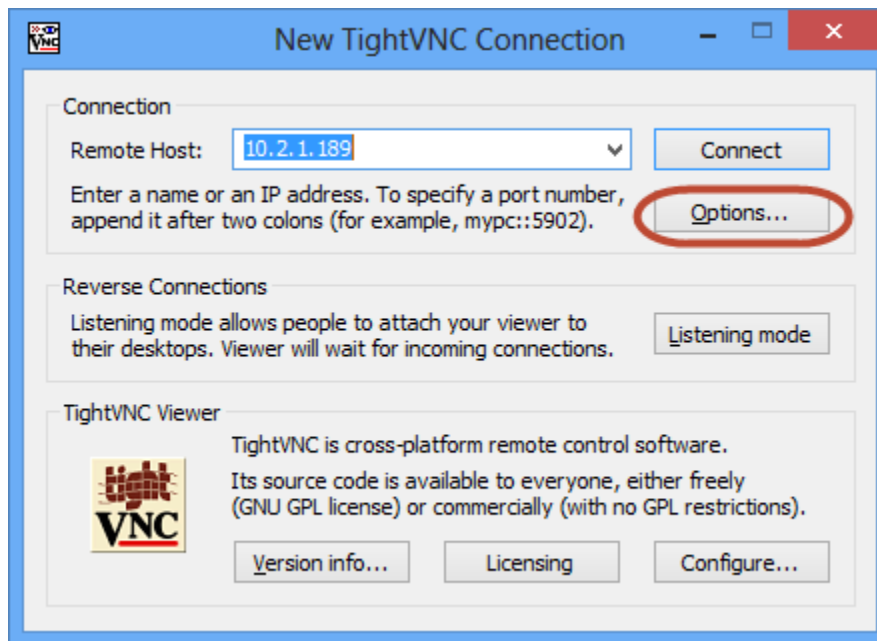

3. In the Local Cursor Shape pane, select **Arrow**, and then click **OK**.

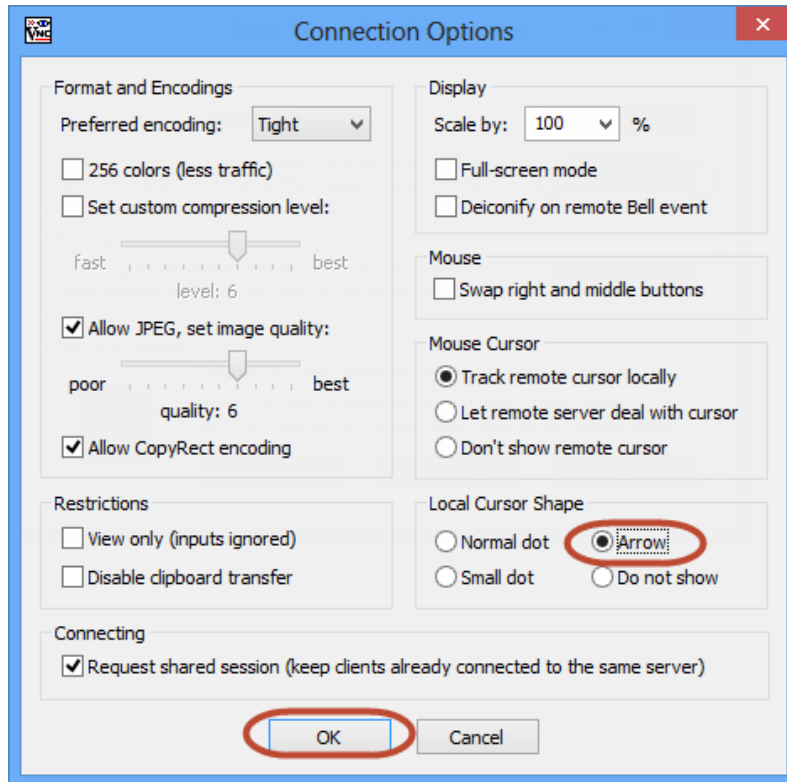

Index

- Active Directory, 130
- altitude, 17
- API, 120
- audio configuration, 174
- back up system, 124
- battery, 15
- browsers, 45
- bulk edit sources, 79
- cable connectors, 24
- cabling, 18
- cabling for interaction, 34
- change controller, 172
- change password, 109
- chassis, 183
- clear messaging, 155
- computer connection, 38
- computer requirements, 38
- configuration worksheet, 186
- connect
 - audio, 37
 - displays, 35
 - DVI Output Capable devices, 33
 - encoding sources, 33
 - Input A and B, 33
- controller
 - assignment, 40
 - configuration, 39
 - deactivate, 42
 - redundancy, 123
 - update, 43
 - wizard, 39
- Controller Manager Wizard, 39
- cursor shape, 189
- default password, 112
- desktop client, 142
- Desktop Client
 - change controller, 172
 - clear source message, 155
 - drag and drop, 150
 - favorites, 154
 - favorites list, 163
 - installation, 144
 - interaction mode, 169
 - layouts list, 157
 - overlays, 169
 - reset decoder streams, 154
 - settings, 149
 - simulator tab, 168
 - snapping, 169
 - source message, 154
 - source tab, 171
 - source thumbnails, 154
 - sources list, 150
 - start, 147
 - test pattern tab, 171
 - treatments list, 161
 - users list, 163
 - wall tab, 166
 - walls list, 157
 - window tab, 170
 - workspaces, 172
- dimensions, 17, 183
- Directory Services, 127
- display wall specifications, 16
- disposal, 15
- document conventions, 13

- drag and drop, 150
- DVI source
 - share, 57
- EDID configuration, 135
- encoding defaults, 119
- environmental conditions, 17
- favorites, 163
- favorites list, 163
- forgot password, 109
- getting started, 22
- global settings
 - system settings, 113
 - update, 113
- glossary, 179
- Groups, 128
- HID-capable device, 34
- install kit, 23
- installation, 23
- installation sequence, 28
- interaction cabling, 34
- interaction mode, 169
- JSON protocol tester, 136
- KVM layer, 123
- labeling, 15
- laptop connection, 38
- last wall layout, 122
- layouts, 157
- layouts list, 157
- maintenance, 178
- management PC, 38
- Managing Groups, 128
- messaging, 154
- Milestone discovery, 62
- Milestone server, 137
- mounting
 - desk, 30
 - monitor, 30
 - rack, 29
 - VESA 1 kit, 30
 - VESA 2 kit, 31
- mounting options, 29
- mouse timeout, 123
- MTU, 121
- multicasting starting address, 120
- network switch, 17
- networking, 32
- node
 - add, 85
 - edit, 87
 - profile, 82
 - stop decoding, 89
 - un-assign, 89
- nodes
 - manage, 81
- ONVIF, 153
- ONVIF discovery, 62
- operating temperature, 17
- overlays, 169
- overview, 19
- password
 - change, 109
 - forgot, 109
- periodic maintenance, 178
- Phoenix Directory, 128
- Phoenix Import Utility, 62
- Phoenix ONVIF Discovery Utility, 79
- Phoenix Quick Control, 140
- planning, 16
- ports, 181
- power connectors, 24
- power cords, 37
- prerequisites, 14
- protocol tester, 136
- PTZ cameras, 153
- quick facts, 189
- rack placement, 16
- redundancy, 123
- references, 14

- regulatory, 184
- relative humidity, 17
- reliability, 184
- reset decoder streams, 154
- resolutions, 183
- restart system, 126
- restore, 125
- safety, 184
- safety precautions, 15
- share DVI source, 57
- simulator tab, 168
- snapping, 169
- software update, 117
- software versioning, 116
- source
 - open, 151
- source list, 53
- source startup style, 122
- source tab, 171
- Source Viewer, 152
- sources
 - add, 54
 - add to favorites, 154
 - application, 75
 - bulk edit, 79
 - delete, 80
 - edit, 78
 - manage, 53
 - Milestone compatible, 62
 - ONVIF compatible, 62
 - Phoenix DVI, 55
 - profile, 78
 - RemoteDesktop, 70
 - RTSP stream, 58
 - stills, 73
 - VNC, 65
- sources list, 150
- specifications, 183
- SSL, 121
- status, 53
- storage temperature, 17
- subwall, 96, 99
 - add, 96
 - create, 99
- support, 13
- system settings, 113
- test pattern tab, 171
- test patterns, 104
- thumbnails, 154
- titling overrides, 77
- Tools, 23
- treatments, 161
- treatments list, 161
- TTL, 122
- unlock user, 110
- users, 163
 - add, 107
 - change password, 109
 - delete, 112
 - edit, 109
 - forgot password, 109
 - manage, 105
 - profile, 107
 - unlock, 110
- users list, 163
- VNC
 - sharing monitors, 69
- wall audio, 174
- wall cursor size, 123
- wall tab, 166
- walls
 - add, 92
 - bulk edit, 104
 - edit, 102
 - manage, 90
 - profile, 90

test patterns, 104
walls list, 157
warnings, 15
warranty, 184
Web Manager, 45

sign in, 48
weight, 17, 183
window tab, 170
workspaces, 172
Z-order, 170

Corporate offices

USA – Cypress
ph: 714-236-8610
Canada – Kitchener
ph: 519-744-8005

Consultant offices

Italy
ph: +39 (0) 2 9902 1161

Worldwide offices

Australia
ph: +61 (0) 7 3624 4888
Brazil
ph: +55 (11) 2548 4753
China (Beijing)
ph: +86 10 6561 0240
China (Shanghai)
ph: +86 21 6278 7708

Eastern Europe and
Russian Federation
ph: +36 (0) 1 47 48 100
France
ph: +33 (0) 1 41 21 44 04
Germany
ph: +49 2161 664540

India
ph: +91 (080) 6708 9999
Japan (Tokyo)
ph: 81 3 3599 7481
Korea (Seoul)
ph: +82 2 702 1601
Republic of South Africa
ph: +27 (0)11 510 0094

Singapore
ph: +65 6877-8737
Spain
ph: + 34 91 633 9990
United Arab Emirates
ph: +971 4 3206688
United Kingdom
ph: +44 (0) 118 977 8000