

User Guide
020-001836-01

Access II Series LCD Panels

CHRISTIE®

NOTICES

COPYRIGHT AND TRADEMARKS

Copyright © 2020 Christie Digital Systems USA Inc. All rights reserved.

All brand names and product names are trademarks, registered trademarks or trade names of their respective holders.

GENERAL

Every effort has been made to ensure accuracy, however in some cases changes in the products or availability could occur which may not be reflected in this document. Christie reserves the right to make changes to specifications at any time without notice. Performance specifications are typical, but may vary depending on conditions beyond Christie's control such as maintenance of the product in proper working conditions. Performance specifications are based on information available at the time of printing. Christie makes no warranty of any kind with regard to this material, including, but not limited to, implied warranties of fitness for a particular purpose. Christie will not be liable for errors contained herein or for incidental or consequential damages in connection with the performance or use of this material. Manufacturing facilities in Canada and China are ISO 9001 certified. Manufacturing facilities in Canada are also ISO 14001 certified.

WARRANTY

Products are warranted under Christie's standard limited warranty, the complete details of which are available by contacting your Christie dealer or Christie. In addition to the other limitations that may be specified in Christie's standard limited warranty and, to the extent relevant or applicable to your product, the warranty does not cover:

- a. Problems or damage occurring during shipment, in either direction.
- b. Problems or damage caused by combination of a product with non-Christie equipment, such as distribution systems, cameras, DVD players, etc., or use of a product with any non-Christie interface device.
- c. Problems or damage caused by misuse, improper power source, accident, fire, flood, lightning, earthquake, or other natural disaster.
- d. Problems or damage caused by improper installation/alignment, or by equipment modification, if by other than Christie service personnel or a Christie authorized repair service provider.
- e. Use of third party product enclosures for environmental protection during outside use must be approved by Christie.
- f. Problems or damage caused by use of a product on a motion platform or other movable device where such product has not been designed, modified or approved by Christie for such use.
- g. Except where the product is designed for outdoor use, problems or damage caused by use of the product outdoors unless such product is protected from precipitation or other adverse weather or environmental conditions and the ambient temperature is within the recommended ambient temperature set forth in the specifications for such product.
- h. Image retention on LCD flat panels.
- i. Defects caused by normal wear and tear or otherwise due to normal aging of a product.

The warranty does not apply to any product where the serial number has been removed or obliterated. The warranty also does not apply to any product sold by a reseller to an end user outside of the country where the reseller is located unless (i) Christie has an office in the country where the end user is located or (ii) the required international warranty fee has been paid.

The warranty does not obligate Christie to provide any on site warranty service at the product site location.

PREVENTATIVE MAINTENANCE

Preventative maintenance is an important part of the continued and proper operation of your product. Failure to perform maintenance as required, and in accordance with the maintenance schedule specified by Christie, will void the warranty.

REGULATORY

Note: This equipment has been tested and found to comply with the limits for a Class B digital device, pursuant to part 15 of the FCC Rules. These limits are designed to provide reasonable protection against harmful interference in a residential installation. This equipment generates, uses and can radiate radio frequency energy and, if not installed and used in accordance with the instructions, may cause harmful interference to radio communications. However, there is no guarantee that interference will not occur in a particular installation. If this equipment does cause harmful interference to radio or television reception, which can be determined by turning the equipment off and on, the user is encouraged to try to correct the interference by one or more of the following measures:

- Reorient or relocate the receiving antenna.
- Increase the separation between the equipment and receiver.
- Connect the equipment into an outlet on a circuit different from that to which the receiver is connected.
- Consult the dealer or an experienced radio/TV technician for help.

CAN ICES-3 (B) / NMB-3 (B)

이 기기는 업무용(A급)으로 전자파적합등록을 한 기기이오니 판매자 또는 사용자는 이점을 주의하시기 바라며, 가정 외의 지역에서 사용하는 것을 목적으로 합니다.

ENVIRONMENTAL

The product is designed and manufactured with high-quality materials and components that can be recycled and reused. This symbol  means that electrical and electronic equipment, at their end-of-life, should be disposed of separately from regular waste. Please dispose of the product appropriately and according to local regulations. In the European Union, there are separate collection systems for used electrical and electronic products. Please help us to conserve the environment we live in!

Content

Package handling.....	5
Unpacking the panel.....	5
Cleaning the panel.....	6
Important safeguards.....	7
General safety warnings.....	7
AC power precautions.....	7
Avoiding image retention.....	8
Parts list.....	8
Product documentation.....	8
Related documentation.....	9
Installing a display panel.....	10
Display panel control joystick.....	10
Remote control.....	13
Installing the Optional Wi-Fi dongle.....	15
Installing the IR extender cable.....	16
Installing an OPS module.....	16
Mounting a display panel.....	16
Installing a display panel on an indented wall.....	17
Configuring the display panel after installation.....	17
Connecting sources to the panel.....	17
Displaying content on multiple display panels.....	17
Controlling CEC-enabled devices.....	17
Selecting the audio destination.....	18
Connecting to a wired network.....	18
Connecting to a wireless network.....	18
Enabling Wake on LAN.....	19
Remotely waking the display panel from standby.....	19
Rotating the on-screen display.....	20
Copying settings from one display panel to another.....	21
Changing the startup logo.....	21
Upgrading the firmware from USB.....	21
Disabling the remote control.....	22
Using the Crestron RoomView Control tool.....	22

Playing content on the display panels	23
Playing media over the network	23
Playing media from USB	24
Playing USB media automatically	24
Displaying an image when no signal is detected	25
Display panel menu contents	26
Troubleshooting	34
Understanding the LED status indicators	34
Wireless network not available	34
Disruption during playback or slow reactions	35
Internet connection not available	35
Audio video sharing not working	35
Invalid domain	36
Remote control does not work	36
Image has artifacts or judder	36
Specifications	37
Physical specifications	37
Power specifications	38
Environmental specifications	38
Regulatory	40
Modification statement	40
Safety	40
RF exposure	40
Electro-magnetic compatibility	40
Environmental	41
Certification Note for Canada	42

Package handling

Learn how to remove the display panel from the packaging and how to handle the display panel.

Unpacking the panel

Learn how to remove the panel from the packaging.

Each LCD panel is packed inside a box carton. To protect the panel during transportation, additional packing material has been placed within the carton.

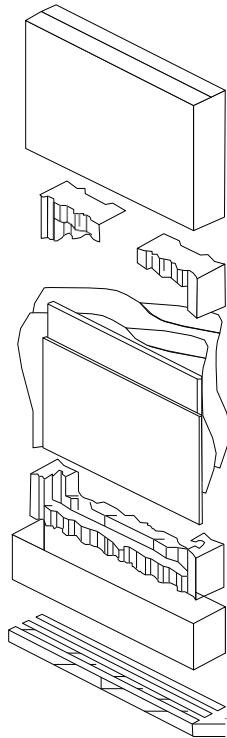

Warning! If not avoided, the following could result in death or serious injury.

- Heavy object - Multi-person lift or properly rated lift equipment is required.

A minimum of three handles is required to safely support the weight of the panel. To avoid damage to the panel, always use multiple handles when moving or lifting the panel. Do not carry the panel by the frame.

1. Before unpacking, prepare a stable, level, and clean surface near a wall outlet.
2. Set the box in an upright position, remove the packing straps and pull out the white carton locks.
3. Lift up the top cover carton.
4. Remove the electrostatic discharge (ESD) bag before removing the display from the bottom tray carton.
5. Remove any additional packaging, such as protective stickers, from the display panel.

Handling and mounting guidelines

Follow these best practices when handling and mounting panels.



Notice. If not avoided, the following could result in property damage.

- When moving the panel, always use the handles. Do not carry the panel by the frame.
- Do not twist, bend, or tilt the panel.
- Do not apply excessive force to the sides of the bezel when mounting the panel or pushing into its locked position.
- Always handle the display panel from the sides or handles.

Follow the following guidelines before removing the panel from the packaging.

- Always use the handles to pick up and carry the panel.
- Leave the panel in the box until the mount is on the wall and you are ready to install the panel.
- To avoid putting undue stress on the panel when mounted, make sure the mount is square, flat, and level.
- Do not rest panels on top of a lower panel.
- When inserting the panel into the wall, pay close attention to adjacent panels.
- Make sure there is a minimum of 0.5 mm between mounted panels to allow for thermal expansion.

Cleaning the panel

Learn how to clean the display panel.

After disconnecting the power cable, wipe contaminated parts and each part of the product screen lightly with a dry and soft cloth.

Do not use a liquid, spray cleaners, or any abrasive cleaners to clean the LCD panel.

Washing with various cleaning agents, brighteners, abrasives, waxes, benzene, alcohol, solvent, surface active agent, may damage the surface of the product.

Important safeguards

To prevent personal injury and to protect the device from damage, read and follow these safety precautions.

General safety warnings

Observe these important safety rules to avoid personal injury or damage to the product.



Warning! If not avoided, the following could result in death or serious injury.

- FIRE AND SHOCK HAZARD! Use only the attachments, accessories, tools, and replacement parts specified by Christie.
- Always provide proper ventilation for the product to prevent overheating.
- FIRE HAZARD! Do not install near any devices that produce heat such as amplifiers, radiators, heat registers, or stoves.



Caution! If not avoided, the following could result in minor or moderate injury.

- Heavy object- Multi-person lift or properly rated lift equipment is required.
- Ensure that any external equipment is properly grounded before connecting to the display device.
- This product is intended for indoor use only.
- Do not operate the product at an altitude exceeding 2000 m.
- Do not operate the product in tropical climate regions.
- Only clean the components with Christie approved products.
- Do not place objects containing liquids on the product.
- Do not spray cleaners or pour liquids directly onto the surface of the product.
- Do not remove the protective housing.

AC power precautions

Learn the safety precautions related to AC power.



Warning! If not avoided, the following could result in death or serious injury.

- SHOCK HAZARD! Disconnect the product from AC before installing, moving, servicing, cleaning, removing components, or opening any enclosure.
- FIRE AND SHOCK HAZARD! Do not attempt operation unless the power cord, power socket, and power plug meet the appropriate local rating standards.
- Never compromise the ground or earth connection of the product.
- SHOCK HAZARD! The AC power cord must be inserted into an outlet with grounding.
- The appliance coupler and main power supply plug must be easily accessible for disconnecting the product from the power source.
- FIRE OR SHOCK HAZARD! Do not overload power outlets and extension cords.
- SHOCK HAZARD! Only use the AC power cord provided with the product or recommended by Christie.
- FIRE HAZARD! Do not use a power cord, harness, or cable that appears damaged.
- TRIP OR FIRE HAZARD! Position all cables where they cannot contact hot surfaces, be pulled, be tripped over, or damaged by persons walking on or objects rolling over the cables.

Avoiding image retention

Image retention can occur when static content appears on the display panel in as little as a few hours. Image retention is not covered under warranty. To prolong the life of your display panel, follow these recommendations.

- Operate the display panel within its rated ambient environment. Christie recommends an operating temperature of 0 to 40 degrees Celsius (32 to 104 degrees Fahrenheit), with a maximum relative humidity of 90%.
- Avoid static content. Christie recommends displaying moving images whenever possible, and using a screen saver with a moving image.
- Turn off the display panel when it is not in use, or use the Scheduling feature to automatically turn off the display panel at preset times of the day.
- Turn on the Pixel shift setting.
- When designing content for the display panels, consider the following:
 - Regularly change the color of the text and background of the content.
 - Move text or images around the display.
 - Use colors of similar brightness levels.
 - Avoid using text color and background color with contrasting brightness, for example black and white.
 - Gray may contribute to image retention.

Parts list

Your display panel is shipped with the following items. If any items are missing or damaged, contact your dealer.

- Remote control and batteries
- IR extender cable
- Product Safety Guide
- NA, UK, EU line cords

Related information

Installing the IR extender cable (on page 16)

Product documentation

For installation, setup, and user information, see the product documentation available on the Christie website. Read all instructions before using or servicing this product.

1. Access the documentation from the Christie website:
 - Go to this URL:<https://bit.ly/2GniMjQ>
 - Scan the QR code using a QR code reader app on a smartphone or tablet.



2. On the product page, select the model and switch to the **Downloads** tab.

Related documentation

Additional information on the LCD panels is available in the following documents.

- Access II series LCD Panels Product Safety Guide (P/N: 020-001848-01)
- UHD552-L Service Guide (P/N: 020-001844-xx)
- UHD652-L Service Guide (P/N: 020-001845-xx)
- UHD752-L Service Guide (P/N: 020-001846-xx)
- UHD862-L Service Guide (P/N: 020-001847-01)
- Access / Secure Series LCD Panel External Controls (P/N: 020-001853-xx)

Installing a display panel

Learn how to install a display panel and connect sources.

Use this display panel for dynamic presentations, educational collaboration, and engaging retail applications.

Display panel control joystick

Learn about the control joystick on the rear of the display panel.

The on-screen display menu cannot be displayed with the control joystick.

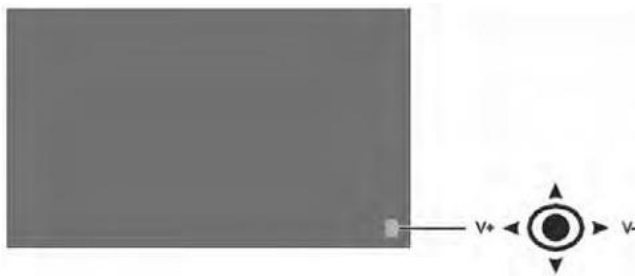

1. To turn on the display panel, press the center of the control joystick.
2. To turn off the display panel and put it into standby mode, press and hold the center of the control joystick for a few seconds.
3. To change the source, press the center of the control joystick.
4. To scroll through the available sources, move the joystick up and down.
5. To change the volume, press the control joystick left and right.
To increase the volume, move the joystick right. To decrease the volume, move the joystick left.

Display components

Learn about the various parts of the display panel.

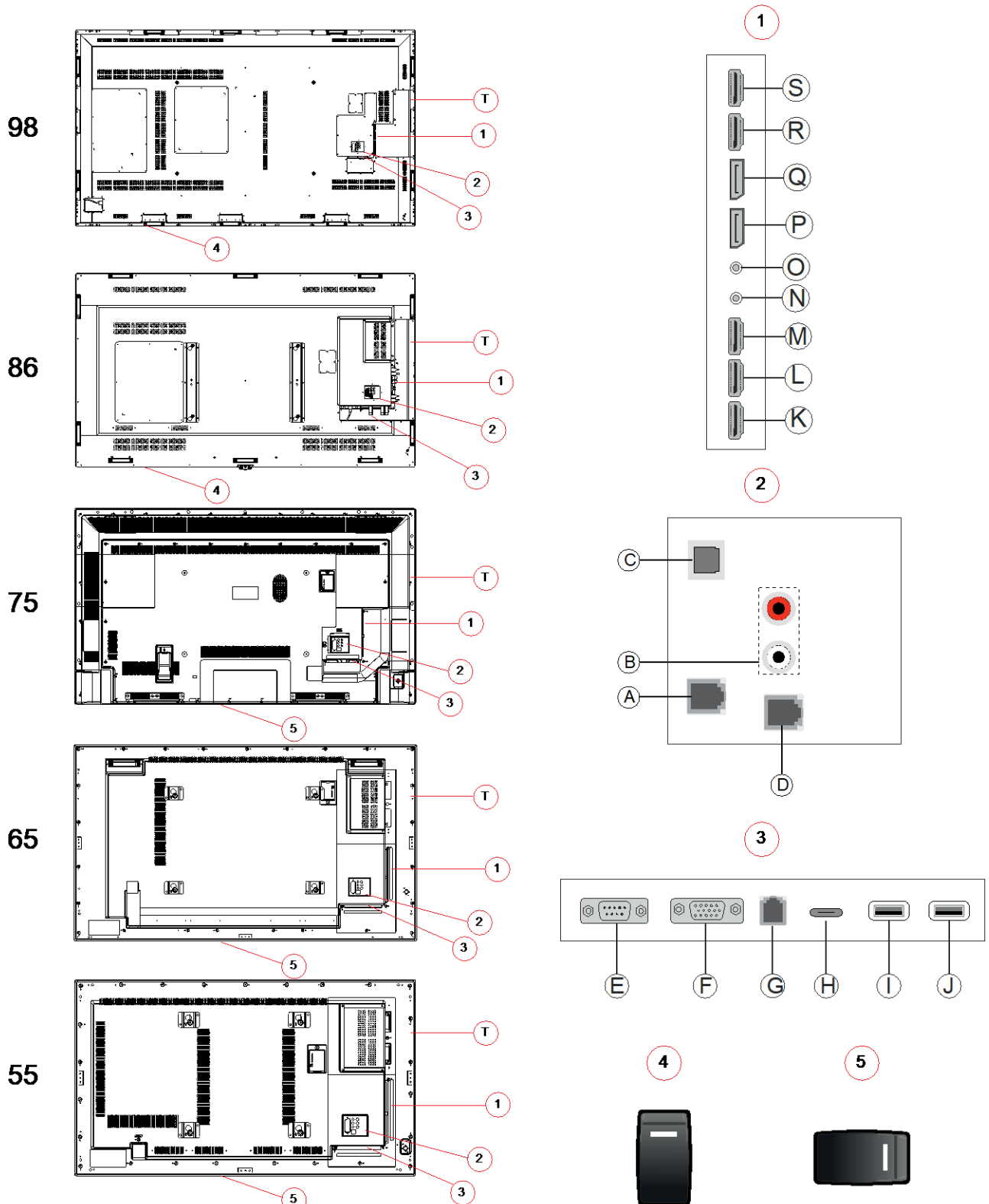

A	RJ12 (for sensor)	M	HDMI4 In
B	Audio in	N	IR Input
C	SFDIF Coaxial out	O	Headphone/Line Out
D	RJ12 (service use only)	P	DP In
E	RS232	Q	DP Out
F	VGA	R	HDMI1 In
G	Ethernet	S	HDMI Out Only the content received from HDMI1 Input port (N) can be outputted from this port. The HDMI output port functions when a source device is connected to the HDMI input.
H	USB Type - C		
I	USB (2.0)		
J	USB (2.0)		
K	HDMI2 In		
L	HDMI3 In	T	OPS Ready

Remote control

Learn the functions of the remote control.

Before you insert batteries in the remote control, consider the following:

- Ensure that the battery polarities are correct.
- Do not mix an old battery with a new one or mix different types of batteries together.
- Do not expose batteries to excessive heat such as sunlight or fire.

If you will not use the remote control for a long time, consider removing the batteries to avoid damage from battery leakage.

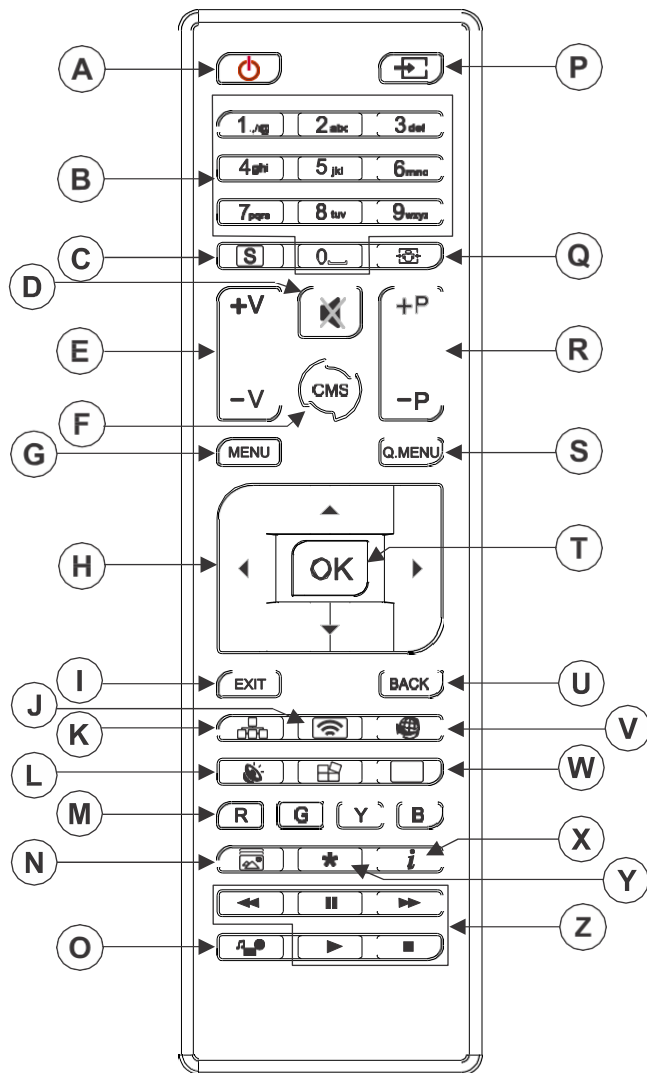

A	Standby —Switches the display panel on and off.	N	Picture Mode —Cycles between picture modes.
B	Numeric buttons	O	Media browser —Opens the media browsing screen.
C	Signage —Displays the Signage Settings menu.	P	Source —Shows all available content sources.
D	Mute —Silences the volume of the display panel.	Q	Screen —Changes the aspect ratio of the screen.
E	Volume —Increases or decreases the volume.	R	Not supported
F	Not supported	S	Quick Menu —Displays a list of menus for quick access.
G	Menu —Displays the main menu.	T	OK —Confirms user selections.
H	Directional buttons —Navigates through sub-menus and settings.	U	Back —Returns to previous screen.
I	Exit —Exits the displayed menu, or returns to the previous screen.	V	Not supported

J	Wireless Display —Opens the wireless display connection screen.	W	Picture —Displays the Picture Settings menu.
K	Network —Displays the Network/Internet Settings menu.	X	Info —Displays information about on-screen content.
L	Sound —Displays the Sound Settings menu.	Y	Not supported
M	Colored Buttons —For colored button functions, follow the on-screen instructions.	Z	Play buttons —Rewind, play, fast forward, stop, or pause media.

Related information

Installing the IR extender cable (on page 16)

Installing the Optional Wi-Fi dongle

Install the Wi-Fi dongle into the port on the panel.

1. On the rear of the panel, using a Phillips screwdriver, remove the port cover over the internal USB compartment (E).

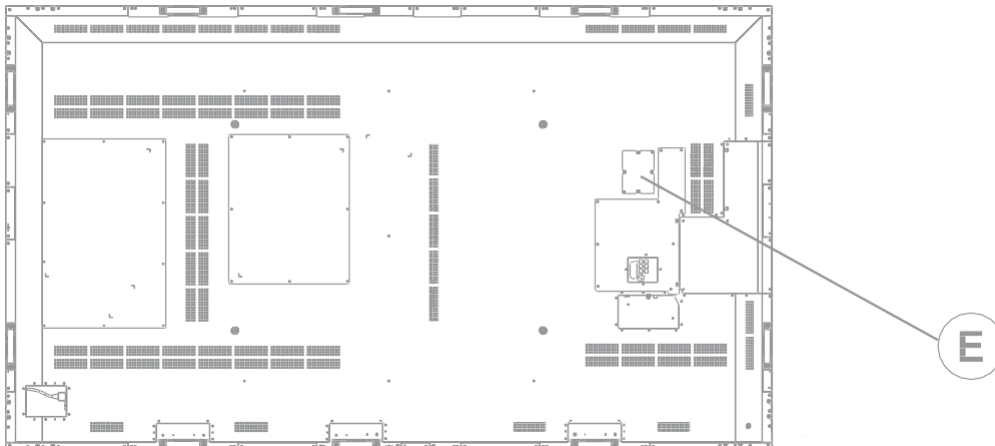

2. Plug the Wi-Fi dongle into the USB port.
Do not reinstall the port cover as it may interfere with Wi-Fi transmission.
3. If you experience Wi-Fi connection issues, connect the Wi-Fi dongle to the display panel with a USB cable, and move the Wi-Fi dongle away from the metal back-plate of the display panel.
The Wi-Fi dongle can be plugged into any of the USB ports on the display panel.

Installing the IR extender cable

For remote control commands to be received by the display panel, the display panel must have the IR extender cable installed.

1. On the rear of the panel, plug the IR extender cable into the display panel.
2. Position the IR receiver so it is visible from the front of the display panel.

Installing an OPS module

To provide a network distributed processor for managing content on the display panel, install an Change to OPS (Open Pluggable Specification) module.



The Access Series display panels only support OPS modules with a power draw of 40 watts or less.

1. On the rear of the display panel, remove the screw securing the OPS slot cover and remove the cover.
2. Insert the OPS module into the slot, ensuring the module is fully seated.
3. Replace and secure the OPS slot cover.
4. Complete any OPS module configuration as identified in the documentation provided by the OPS manufacturer.

Mounting a display panel

Use only the approved wall-mount kit designed for your display panel.



Caution! If not avoided, the following could result in minor or moderate injury.

- TIP HAZARD! Center align the product on the stand or mount.



Ensure the IR extender cable is installed before mounting the panel. For UHD982-P display panels, install the Wi-Fi dongle before mounting the panel.



Ensure that the signal cables are installed before mounting the panel.

If you decide to wall-mount a display panel, ensure that the wall-mount bracket is installed according to the instructions that are included with it. The wall must be capable of supporting three times the weight of the display panel, or be reinforced.

To ensure the mounting brackets clear any protrusions on the rear of the panel, Christie recommends using spacers with a minimum height of 6.35 mm (.25 in).

Mounting brackets may block access to the connector ports. To ensure the preferred mount allows access to the connectors, refer to the display panel line drawings on www.christiedigital.com for measurements.

When mounting the UHD982-P in portrait mode, connect signal cables before mounting the panel. Ensure the AC power input is on the bottom edge of the display panel and that the ports and OPS slot are on the top edge of the display panel. It may be necessary to move the Christie name plate to the bottom edge of the display panel. Use a #1 Phillips screwdriver to remove the screws from the nameplate, and to remove the extra screws from the secondary nameplate location on the bottom of the panel.

At the location where the space between tiles is the tightest, use the spacer tool to ensure there is a minimum of 0.5mm, or the thickness of a credit card, between adjacent LCD display panels.

Related information

Installing the IR extender cable (on page 16)

Installing the Wi-Fi dongle (on page 15)

Installing a display panel on an indented wall

When installing the display panel on an indented wall, ensure there is sufficient space around the display panel and the wall for ventilation.

The ambient temperature must be between 0 to 35°C (32 to 95°F). Do not expose the product to direct sunlight.

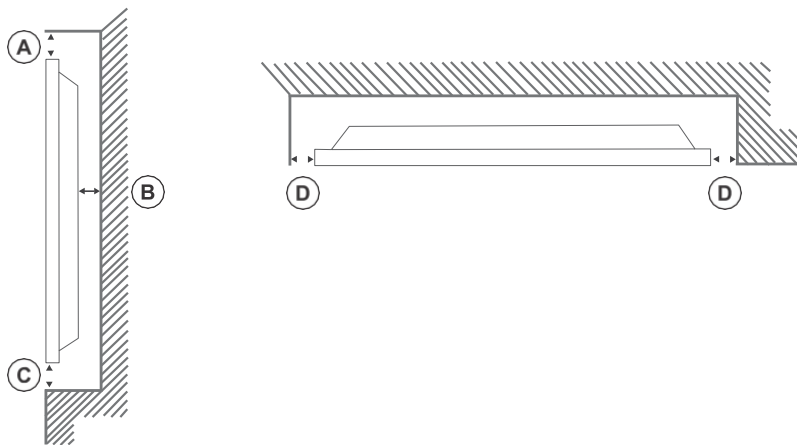

Configuring the display panel after installation

After turning the display panel on for the first time, complete the initial configuration.

1. Power on the display panel.
2. Using the display panel remote, select the display language and press **OK**.
3. Select the country and press **OK**
4. Configure the Signage settings, such as the OSD orientation and display panel ID. Model name, Serial number, and Software version cannot be modified.
5. Press **OK**.
6. Configure the display panel to connect to a wired or wireless network.
7. Press **OK**.

8. To repeat this process and reset the display panel settings to the factory defaults, select **Signage Settings > First time installation** and press **OK**. Accept the confirmation message.
9. To exit the menu, on the remote press **Menu** again.

Connecting sources to the panel

Select the port the source computer is connected to.

1. Connect a cable from the source computer to the display panel.
2. On the display panel remote, press **Menu**.
3. Select **System > Settings > Sources**.
4. Select the source input and press **OK**.
5. To exit the menu, on the remote, press **Menu** again.

Displaying content on multiple display panels

Configure the display panels to show content on multiple devices.

The maximum number of display panels that can be connected by using daisy-chaining may differ depending on the capacity of the source device. The image displayed on all display panels is defined by the source device. For example, to stream four different FHD images, the source device should be capable of supporting this operation.

1. Connect a cable between the DisplayPort or HDMI output port on one display panel and the DisplayPort or HDMI input port on another display panel.
2. Set the input source on the display panels to the appropriate input.
3. If using the DisplayPort, on the display panel remote, press **Menu**.
4. Select **System > Settings > More > DP Stream Setting** and select a method of connecting the display panels.
 - **MST**—Select MST (Multi-Stream Transport) when using an MST hub between the source computer and multiple display panels, extending a single image across multiple display panels. This is the default.
 - **SST**—Select SST (Single-Stream Transport) when the same image is displayed on all connected display panels. The maximum number of the display panels that can display HDCP encrypted content is seven. For content that is not HDCP encrypted, if the signal is stable and there is no cable loss, there is no limitation to the number of display panels.
5. To exit the menu, on the remote press **Menu** again.

Controlling CEC-enabled devices

Control CEC-enabled devices connected through the HDMI ports using the display panel remote.

1. On the remote, press **Menu**.
2. Select **System > Settings > More > CEC**.
3. Select **Enable**.
4. On the remote control, press **Source**.
5. In the Sources list, select the HDMI input of the connected CEC device.

When a new CEC source device is connected, the connected HDMI port name is replaced with the name of the CEC source device in the Source menu.

6. To exit the menu, on the remote, press **Menu** again.

Selecting the audio destination

Configure whether the audio is played through an amplifier or through the display panel.

Compatible audio devices must support System Audio Control.

1. On the display panel remote, press **Menu**.
2. *Enable the CEC option* (on page 18).
3. Select **System > Settings > More > Speakers**.
4. Select the destination for the audio.
 - **Display**—All audio is played through the display panel speakers.
 - **Amplifier**—All audio is played through the connected sound system, the display panel speakers are muted, and the volume is controlled using the remote for the display panel.

The display panel also supports also ARC (Audio Return Channel) feature. This is an audio link meant to replace other cables between the display panel and the audio system.

When ARC is active, the audio of the display panel is not muted automatically. To hear audio from connected audio devices only, the volume of the display panel must be turned down manually.

5. To exit the menu, on the remote, press **Menu** again.

Connecting to a wired network

For wired connections, connect the display panel to the modem or router with an Ethernet cable.

1. On the display panel remote, press **Menu**.
2. Select **System > Settings > Network/Internet Settings > Network Type**.
3. Select the **Wired device** network connection.
4. If necessary, configure the network connection.
 - a) Select **Advanced Settings** and press **OK**.
 - b) Change the IP address setting to **Manual** and type the IP address for the display panel.
 - c) To save the settings, press **OK**.
 - d) Repeat steps 4b and 4c for the DNS settings.
5. To exit the menu, on the remote, press **Menu** again.

Connecting to a wireless network

Content stored on a mobile device connected to the wireless network can be accessed and displayed on the display panel through the Media Browser.

The display panel supports 802.11 a,b,g and n type modems. Christie recommends using the IEEE 802.11n communication protocol.

The display panel cannot connect to networks with a hidden wireless network name (SSID). If the modem shares the same SSID as another modem in the area, change the SSID of the modem. Use a wired connection if you experience problems with a wireless connection.

1. Plug the Wi-Fi dongle into a USB port on the rear of the display panel.
2. On the display panel remote, press **Menu**.
3. Select **System Settings > Network/Internet Settings > Network Type**.
4. Select the **Wireless device** network connection.
The display scans for wireless networks automatically.
5. Select the network from the list.
6. If required, using the directional buttons on the remote, enter the network password and press **OK**.
Alternatively, if the router has a WPS (Wi-Fi Protected Setup) button, select **Press WPS on your Wi-Fi router** and press **OK**, and press the WPS button on the router.
When the IP address is displayed on the screen, the connection with the network has been established.
7. If necessary, configure the network connection.
 - a) Select **Advanced Settings** and press **OK**.
 - b) Change the IP address setting to **Manual** and type the IP address for the display panel.
 - c) To save the settings, press **OK**.
 - d) Repeat steps 7b and 7c for the DNS settings.
8. To exit the menu, on the remote press **Menu** again.

Enabling Wake on LAN

Configure the display panel to accept Wake on LAN commands.

1. Disable Quick Standby.
 - a) On the remote, press Menu.
 - b) Navigate to **Signage Settings > Power up settings > Quick Standby****
 - c) Ensure Quick Standby is disabled.
2. Enable Wake on LAN.
 - a) Using a terminal program, access the display panel.
 - b) Run the following command: `SWOL 1`
 - c) To verify Wake on LAN is enabled, run the following command: `GWOL`

Remotely waking the display panel from standby

To remotely wake the display panel from standby, configure and use Wake on LAN software.

1. Download the Wake On LAN (WOL) software.

Free Wake On LAN software packages are available for downloading from the internet. The steps below are for the Aquilia WOL software.

2. To open WakeOnLAN, select the downloaded file and click **New Host**.
3. Select the Wake Up page.
 - a) Enter the MAC address, which is the same as the display panel.
 - b) Enter the broadcast IP address.

The domain is the same as the computer.

For example, the IP address of the computer is 10.0.21.105, the subnet mask is 255.255.0.0, and the broadcast IP address is set to 10.0.255.255.
4. Enter any IP address in the FQDN/IP.

Leave all other fields at their default values.
5. Select the newly added host, right-click, and select **Wake Up**.

Rotating the on-screen display

Change the orientation of the on-screen display.

1. On the display panel remote, press **Menu**.
2. Select **Signage Settings > Controls > OSD Orientation** and select the appropriate orientation.
3. To exit the menu, on the remote, press **Menu** again.

Copying settings from one display panel to another

For installations with multiple display panels, copy the settings from one display panel and import them onto the other display panels.

The settings copied include database files, all preference data, and the signage and link option settings.

The Copy from USB and Copy to USB menu options are only available when a USB device is connected to the display panel.

1. Copy the settings to an external USB storage device.
 - a) Connect the USB storage device to the display panel.
 - b) On the display panel remote, press **Menu**.
 - c) Select **Signage Settings > USB > Clone to USB**.
The settings are saved to a folder named `Cloned <number>`.
2. Copy the settings from the external USB storage device to the display panel.
 - a) Connect the USB storage device to the display panel.
 - b) On the display panel remote, press **Menu**.
 - c) Select **Signage Settings > USB > Clone from USB**.
 - d) Navigate to the folder created in 1C and click **OK**.
3. To exit the menu, on the remote, press **Menu** again.

Changing the startup logo

Update the logo displayed when the display panel starts.

1. On a USB storage device, create a folder named `spi`.
2. Copy a .jpeg file into the `spi` folder.
3. Rename the .jpeg file to `boot_logo.bin`.
4. Connect the USB storage device to the display panel.
5. If the Media Browser is displayed, to close it press **Exit** on the remote.
6. On the display panel remote, press **Menu**.
7. Select **Signage Settings > USB > USB operations** and on the remote press **Enter**.
The boot logo is updated.
8. Restart the display panel.

Upgrading the firmware from USB

Install the new firmware to upgrade the display panels.

1. Download the latest software from www.christiedigital.com and unzip the file.
2. Navigate to `access_7.xx.x.x_mb130.bin`

3. Copy the `access_7.xx.x.x_mb130.bin` file to the root of a USB storage device.
4. Connect the USB storage device to the display panel.
5. If the Media Browser is displayed, to close it press **Exit** on the remote.
6. On the display panel remote, press **Menu > 1505**.
7. In the confirmation dialog, select **Yes**.
 During the upgrade process the display panel restarts. After the display panel restarts, while the upgrade finishes nothing is displayed on the panel and a red LED blinks in the top right corner. The process may take a few minutes to complete.

Disabling the remote control

Turn off the ability to control the display panel using the remote control.

The remote control functions in Stand-By mode independently from this setting.

1. On the display panel remote, press **Menu**.
2. Select **Signage Settings > Controls > RCU Inhibit** and select **On**.
 If this option is set as **On** only the Volume Up/Down, Numeric Buttons, and the Standby button on the remote are functional.
3. To enable the remote, press **MENU > 1973** on the remote control keypad.
4. Select **Signage Settings > Controls > RCU Inhibit** and select **Off**.

Using the Crestron RoomView Control tool

Crestron RoomView provides a central monitoring station for 250+ control systems on a single Ethernet network (more are possible, the number depends on the combination of IP ID and IP address).

Crestron RoomView monitors each projector, including projector's online status, system power, light source life, network setting and hardware faults, plus any custom attribute as defined by the Administrator. The Administrator can add, delete, or edit room information, contact information and events, which are logged automatically by the software for all users.



Crestron RoomView functions are set according to the models and specifications of the product.

For further information, visit <http://www.crestron.com> and <http://www.crestron.com/getroomview>.

Playing content on the display panels

Learn how to play images, video, and audio on the display panels.

Playing media over the network

Play content available on the same network as the display panel.

For higher playback quality, Christie recommends using a wired connection when connecting the display panel to other devices.



Third party software such as Nero MediaHome may be required to share content over the network.

1. Configure the display panel to connect to a wired or wireless network.
2. On the display panel remote, press **Media Browser**.
3. Select the media type and press **OK**.
4. Select the media server or network to connect to and press **OK**.
To refresh the device list, on the remote, press the green button.
5. If the selected media type is video, navigate to the location of the video files and select the file to play.
6. To play other media types, go back to main Media Browser menu and select the media type and the network again.
To switch to next media type quickly without changing the network, press the blue button.
7. Play the selected content.
 - To play all files in the list as a loop, in their original order, start playback with the **Play** button and activate
 - To play the same file continuously, start playback with the **OK** button and activate
 - To shuffle all files in the list once, start playback with the **Play** button and activate
 - To shuffle all files in the list indefinitely, start playback with the **Play** button and activate and
8. To exit the menu, on the remote, press **Menu** again.

Related information

Connecting to a wired network (on page 19)

Connecting to a wireless network (on page 19)

Playing media from USB

Play photos, music, and movie files stored on a USB device by connecting it to the display panel.

USB memory sticks and 2.5" and 3.5" inch external hard drives with external power supplies can provide content to the display panel through the USB inputs of the display panel. Certain types of USB hard drives, flash drives, and USB devices such as MP3 players may not be compatible with the display panel. The display panel supports FAT32 and NTFS disk formatting.







The following media types are supported: *mpg*, *mpeg*, *mp4*, *mkv*, and *avi*.

If both an internal USB device and external device are inserted, the media player uses the external device only.

USB hubs can be used with the USB inputs of the display panel. External power supplied USB hubs are recommended. When connecting a USB hard drive, use the USB inputs of the display panel directly.

Back up the files on your storage devices before connecting them to the display panel.

Before removing the USB device, ensure files are not being read or played from the device. Failure to do so may cause physical damage to the USB player and the USB device itself.

1. Back up the files on the storage devices before connecting them to the display panel.
2. Connect a USB hard drive or flash drive to one of the USB inputs located on the side of the display panel.
3. On the display panel remote, press **Media Browser**. 
4. Select the media type and press **OK**.
5. Navigate to the media to show on the display panel.
The Media Browser menu can only display 1000 image files stored on the connected USB device.
6. Play the selected content.
 - To play all files in the list as a loop, in their original order, start playback with the **Play** button and activate .
 - To play the same file continuously, start playback with the **OK** button and activate .
 - To shuffle all files in the list once, start playback with the **Play** button and activate .
 - To shuffle all files in the list indefinitely, start playback with the **Play** button and activate  and .
7. To exit the menu, on the remote, press **Menu** again.

Playing USB media automatically

Automatically start playing the media content on a USB device.

The content types available through the Media Browser are played in a predetermined order: photo, video, and then audio. If photo files are in the root directory of the USB device, the Media Browser plays the photos in alphabetical order by file name. If no photo files exist, the USB device is checked for video content and then audio.

If **Signage settings > Controls > No signal** is set to **Failover**, the Media Browser Autoplay setting is ignored and any media on the connected USB device is played.

1. On the display panel remote, press **Media Browser**. 
2. Select **Settings**.

3. Enable the **AutoPlay** option.
4. To exit the menu, on the remote, press **Menu**.

Displaying an image when no signal is detected

Set the behavior of the display panel when no signal is detected from the selected input source.

1. In the display panel menu, select **Signage Settings > No Signal**.
2. To set the display panel to check the connected USB devices for available files to play, select **Failover**.

If no playable files are available or a USB device is not connected to the display panel, the No Signal image is displayed and the display panel turns off after five minutes.

If the No Signal image is not available, the message "No Signal OSD" is displayed on the screen, and the display panel turns off after five minutes.

Display panel menu contents

Learn the structure of the display panel menu tree.

System > Picture menu

Mode	You can change the picture mode to suit your preference or requirements. Picture mode can be set to one of these options: Text, Game, Sports Signage and Natural
Contrast	Adjusts the light and dark values on the screen.
Brightness	Adjusts the brightness values on the screen.
Sharpness	Sets the sharpness value for the objects displayed on the screen.
Colour	Sets the colour value, adjusting the colours.
Energy Saving	<p>This Display is designed to be environmentally friendly. If you set this option to Minimum, Medium, Maximum or Auto the display reduces energy consumption by regulating the backlight level accordingly. If you like to set the backlight level to a fixed value set as Custom and adjust the Backlight (located under this setting) manually using left or right buttons on the remote.</p> <p>If the right button is pressed while auto option is selected the left button is pressed Custom option is selected, "Screen will be off in 15 seconds." message will be displayed on the screen.</p> <p>Select proceed and press OK to turn the screen immediately. If no button is pressed, the screen turns off in 15 seconds. Press any button on the remote or on the Display to turn the screen on again.</p> <p>When the display is not in use, please switch off or disconnect the display from the mains plug. This will also reduce energy consumption.</p> <p>NOTE: Available options may differ depending on the selected mode.</p>
Backlight	Controls the backlight level. The backlight function will be inactive if the Energy Saving is set to an option other than Custom.

Advanced Settings	
Dynamic Contrast	Change the dynamic contrast ratio to the required value.
Noise Reduction	If the signal is weak and the picture is noisy, use the Noise Reduction setting to reduce the amount of noise.
Colour Temp	Sets the desired colour temperature value. Cool (1300K), Normal (9300K) and Warm (8500K) options are available.
Picture Zoom	Sets the desired image size format.
Picture Shift	Available depending on the Picture Zoom setting. Highlight and press OK , then use directional buttons to shift the picture upwards or downwards.

Film Mode	Films are recorded at a different number on frames per second. Turn this feature on when you are watching films to see the fast motion scenes clearly.
Skin Tone	Skin tone can be changed between -5 and 5.
RGB Gain	Adjusts the strength of the red, green and blue colours. You can use this feature for fine adjustment of white balance in the picture.
HDMI Full Range	While watching from a HDMI source, this feature will be visible. You can use this feature to enhance blackness in the picture.
Reset	Resets the picture settings to factory default settings (except Game mode).

System > Sound menu

Volume	Adjusts the volume level.
Equalizer	Selects the equalizer mode. Custom settings can be made only when in User mode.
Balance	Adjusts whether the sound comes from the left or right speaker.
Headphone	Sets headphone volume. Please ensure before using headphones that the headphone volume is set to a low level, to prevent damage to your hearing. Only available if Headphone/Lineout option is set to Headphone.
AVL (Automatic Volume Limiting)	Sets the sound to obtain fixed output level between sources. If the Dolby Audio menu item is set to an option other than Off the AVL setting options will change. Auto , Night , Normal and Off options are available. In Auto mode, the TV switches to Normal or Night mode automatically according to the current time information. If no time information is available this option always functions as Normal . When the TV switches to Night mode for the first time after setting this option as Auto , an information bar appears on the screen. Note that compared to Normal mode Night mode provides more aggressive dynamic compression control which is suitable for silent environments.
Headphone/Lineout	When connecting an external amplifier to the Display using the headphone jack, select this option as Lineout . If connecting headphones to the Display, set this option as Headphone . Ensure before using headphones that this menu item is set to Headphone . If set to Lineout , the output from the headphone socket is set to maximum which could damage your hearing. A warning message will be displayed on the screen when switched to Lineout option. Remove the headphone and press OK to continue.
Dynamic Bass	Enables or disables dynamic bass.
Dolby Audio	Smart, Movie, Music, News and Off options are available. Set to Off to disable. Note: Some items in Sound menu are grayed out and unavailable if set to an option other than Off.
Surround Sound	Enables or disables surround sound.
Digital Out	Sets the digital out audio type to PCM or Compressed.

System > Network menu

Network Type	Disable the network connection or change the connection type.
Scan Wireless Networks	Starts a search for wireless networks. This option is available if the Network Type is set as Wireless Device.
Press WPS on your wifi router	If the modem/router device has WPS, directly connect to it using this option. Highlight this option and press OK. Go to your modem/router device and press the WPS button on it to make the connection. This option is available if the Network Type is set as Wireless Device.
Internet Speed Test	Start a speed test to check your connection bandwidth. The result is displayed on the screen when finished.
Advanced Settings	Change the IP and DNS configurations of your display.
Wake On	Enable or disable this feature by setting it as On or Off.
Note: For detailed information on the options of this menu refer to the Connectivity section.	

Signage Settings Menu

Device Info		
	Set ID	Sets the device ID. select a value between 0 to 99 using the numeric buttons on the remote to identify your Display.
	Software Upgrade	Displays current software version. Press OK to see the upgrade options. Use these options to start a manual search for software updates and set the automatic scan preference.
	Serial number	Displays serial number of the unit. (Cannot by changed by the user.)
	Model name	Displays model name of the unit. (Cannot by changed by the user.)
	Save model information	Copies the model information data of the unit to a connected USB device.
	Display Life Time	Displays the duration of life of the unit.
Controls		
	OSD Orientation	Sets the on-screen display (OSD) rotation of your display. Landscape, Portrait 1 and Portrait 2 options are available.
	Browser Orientation	Sets the rotation of the browser. Landscape, Portrait1, and Portrait2 options are available. One of the portrait options is set by default depending on the model. Rotates only the browser and applies changes after the display is switched off and on again. Note: Portrait mode does not support html pages which include videos.
	Pixel Shift	Enables or disables pixel shifting. Used to avoid image retention (after image effects) occurring when displaying fixed patterns or still images for long periods of time. If enabled, the picture and OSD are shifted at specified time intervals.
	No Signal	<p>Sets the behavior preference of the Display, when no signal is detected from the currently set input source. Failover and Input Search options are available.</p> <p>If Failover is selected, the Display checks the connected USB device for available files to play. If no playable files are available or no USB device is connected to the Display, the No Signal image will be displayed. If No Signal Image is available, No Signal OSD will be displayed on the screen. The setting of the USB Auto Play option in the Settings>System>More menu is not important, in Failover mode it continues to function.</p> <p>If Input Search is selected the Display searches all available input sources consecutively to find a signal. If no signal is detected from other available sources, No Signal OSD is displayed and the signal search continues according to the order in the Sources list until the ANDROID source is reached as it is always be available.</p> <p>How to install No Signal Image Install the file you want to use onto the root directory of any USB storage device and name it as "NoSignalImage.png". Connect the USB storage device to the Display. Highlight USB Operations option in the Settings>Signage>USB menu and press OK</p>
	No Signal Delay	Sets a delay value to the ' No Signal ' preferences when the Display is in No Signal state. After the set delay time is expired ' No Signal ' preferences are applied. If the No Signal option is set as Input Search, this option is not be available.

	No Signal Power Off	<p>When enabled the display turns itself off after a period of five minutes, if no signal is received from the selected source. This feature only works if all of the following circumstances occur:</p> <ul style="list-style-type: none"> - No Signal option is set as Failover. - USB device is not connected to the Display / USB device is connected but there are no playable files installed on the USB device. - If the No Signal option is set as Input Search, this option is not available.
	Panel Lock	Set to Off to prohibit the use of the buttons on the display.
	RCU Inhibit	<p>Set to On to inhibit the use of the remote. Remote control functions in Stand-By mode independently from the setting of this option. To turn this option off and to use the remote again, press MENU/M-1-9-7-3 buttons on the remote consecutively. Signage menu appears. Enter the Controls menu and set this option to Off.</p>
	UART 0	<p>Select ASCII/HEX protocol for UART 0. Default value is ASCII. Do not restart the display restart the Display after selection to work with the protocols correctly. If the selection is changed, the latest selected protocol is preserved and started when the display is booted up. Note that ASCII/HEX selection is not working while debug logs are enabled. If wrongly changed to HEX while debug logs are enabled, revert the selection to ASCII and reboot the display to correct the debug logs and the ASCII protocol behaviour. Also note that HEX protocol works with the baud rate value 19200 for UART 0.</p>
	UART 1	<p>Select ASCII/HEX protocol for UART 1. Default value is HEX. Do not restart the display after selection to work with the protocols correctly. If the selection is changed, the latest selected protocol is preserved and started when the Display is booted up. Note: the ASCII/HEX selection is always working as expected. It does not matter if the debug logs are enabled or not. Note: The HEX protocol Works with the baud rate value 9600 for UART1</p>
	Menu Lock	Block the usage of the menu button on the remote by setting this item as All menus. When you press the menu button, enter the PIN you have defined in the First Time Installation. Set to Off to disable this function.
	Auto Source Switch	<p>If this option is enabled the display switches to the currently active HDMI source automatically when a device is connected to the display through the HDMI1 or HDMI2 input socket. Set as Enabled to enable this feature. When the HDMI source is removed, the display switches to other active HDMI source. If no other devices are connected to the display and the HDMI Wake UP option for the related HDMI source is enabled the Display switches into the standby mode. A three second restriction exists for successive connected HDMI sources. The second HDMI device must be plugged in for three seconds after the first HDMI device is plugged in. Note: This feature applies for HDMI1 and HDMI2 input sockets only. Refer to the General View section to see the HDMI inputs.</p>

Power Up Setting Menu

Power Up Mode	Configures the power up mode preference. Last State, Always On and Standby options are available.
Quick Standby	If enabled, the display can be turned on again with the RS232 and LAN commands if it is turned off through it. Press the left or right buttons to enable or disable the feature.
Power on Delay	Sets a delay value at power on. This value can be set from 0 to 2000 ms in steps of 100 ms. The Display turns on after the set delay time is expired.
Auto Launch	Configures the auto launch preference. CMS(Start url), Open Browser(Open Browser initial page), and Disabled options are available.
Boot Up Picture Mode	Configures the picture mode preference at power on. If set as Off the last set picture mode will be used at power on.
HDMI1 Wake Up	<p>If set as Enabled, the display turns on with the HDMI1 input source, when it is switched on. This feature works based on the HDMI 5V signal. When this signal is active, the display wakes up and when the signal is inactive the Display shuts down. Disable this option by setting as Disabled. To use this feature in conjunction with the Auto Source Switch Christie recommends enabling the Auto Source Switch option in the Signage>Controls menu.</p> <p>If any Scheduler is set, this option is inactive and cannot be set as Enabled. and can not be set as Enabled.</p> <p>Note: This feature may not be available depending on the model of your unit.</p>
HDMI2, HDMI3, HDMI4 Wake Up (Optional)	<p>If is set as Enabled, the display turns on with the active input source (HDMI2, HDM3 or HDMI4 depending on which input source is active), when it is switched on.</p> <p>Works based on the HDMI 5V signal. When this signal is active the display wakes up and when the signal is inactive the Display shuts down. You can disable this option by setting as Disabled. To use this feature in conjunction with the Auto Source Switch feature, Christie recommends enabling the Auto Source Switch option in the Signage>Controls menu.</p> <p>If any Scheduler is set this option is be inactive and can not be set as Enabled.</p> <p>Note: This feature or HDMI3 and HDMI4 options may not be available depending on the model of your unit. If multiple devices are connected to the display through HDMI input sockets, this feature does not work.</p>
USB	
Clone to USB	Copies the database files from the unit to a connected USB device.
Clone From USB	Copies the database files from a connected USB device to the unit.
Copy app cache from USB	Copies app cache data from a connected USB device to the unit. Note: This feature may not be available depending on the model of your unit.
USB Information	Press OK to open the USB information menu screen. Current Total space and Free space information of the connected USB device will be displayed. You can also format the connected USB device using the Format Disk option in this menu (FAT32 format only).
USB Operations	Highlight and press OK to perform USB operations

	USB Option	Set to Off to disable the USB ports on the Display. Set this option as 5V to provide 5 volts power over USB. In this case, it is not available to browse the USB content using the Media Browser feature of the display.						
	Safely Remove	Use this option to remove the devices connected to the USB inputs of the Display safely. Highlight this option and press OK . Wait for the message to be displayed on the screen indicating you can remove your device and then remove your device. Failure to do so, may cause problems when connecting the your USB device to other devices and you may have to format your USB device.						
Video wall settings		<p>Press OK to open the Video Wall Settings menu screen. Video Wall Settings, Row Count, Column Count, Cell, and Offset options are available.</p> <p>Video Wall Settings: Enable or disable the Video Wall function by pressing Left/Right directional buttons.</p> <p>Row count: Adjust the number of Video Wall rows by pressing Left/Right directional buttons. The maximum number that can be set is 10.</p> <p>Column count: Adjust the number of VideoWall columns by pressing Left/Right directional buttons. The maximum number that can be set is 10.</p> <p>Cell: Each Video Wall unit is called Cell. Adjust the number of a cell by pressing Left/Right directional buttons. The maximum number that can be set is 100. To disable video wall function of the unit and display the image in full-screen mode, the Cell option should be set as 0.</p> <p>Offset: Offset setting is used to adjust the refractions at the sides of the picture depending on the bezel thickness between Video Wall units (Cells). The maximum number that can be set is 50.</p> <p>For example; For a 2x3 video wall matrix, Row count option should be set as 2 and Column count option should be set as 3. Numbers of the cells in a video wall matrix are determined as shown in the template below. If setting the display, which is positioned same as the display with the number 1 in this template, then the Cell option should be set as 1 for this display.</p> <div style="text-align: center;"> <table border="1" data-bbox="862 1211 1170 1417"> <tr> <td style="text-align: center;">1</td> <td style="text-align: center;">2</td> <td style="text-align: center;">3</td> </tr> <tr> <td style="text-align: center;">4</td> <td style="text-align: center;">5</td> <td style="text-align: center;">6</td> </tr> </table> </div>	1	2	3	4	5	6
1	2	3						
4	5	6						

<p>OPS settings</p>	<p>Using the scheduler options set the unit to turn on automatically at defined time intervals with the defined input source setting on the required days of the week. Press OK to open the Scheduler Settings menu screen. You can set up to four different schedulers.</p> <p>Highlight the first checkbox of the desired scheduler option and check it by pressing the OK button. Define a time for the Display to be turned on automatically. Highlight the time box next to the first checkbox and press the OK button, use the directional and numeric buttons on the remote to set a time. Press the OK button again when done.</p> <p>Perform the same steps to set a time for the Display to turn off.</p> <p>Define a source for your scheduler. Highlight the box located under the Source tab for your scheduler option and press the OK button. Set as required using the left/right directional buttons. The Source option is set as Last Source, the input source is not changed at the power-up. If the Source option is set as USB, the media files in the connected USB device are played back automatically as explained in the section entitled 'USB Auto Play Feature'.</p> <p>Select the week day(s) for your scheduler setting to be activated. Highlight the checkbox under the required day tab and press OK to check. Highlight and press OK a second time to uncheck a box. The scheduler is active on the checked days of the week.</p> <p>Set a backlight scheduler. After setting the On, Off, Source and day options highlight the checkbox under the Backlight column and press OK. The checkbox is checked and backlight level setting screen is displayed. Set On value and Off value using the sliders and then press OK to save. If you set a backlight scheduler, the display does not turned on or off, only the backlight values are changed at defined time interval. If Source option is set as Last Source the backlight settings will be applied to all sources; otherwise, the settings are applied to the selected source only.</p> <p>Press the Green button on the main scheduler screen to save settings when complete.</p>
<p>Scheduler Settings</p>	<p>Using the scheduler options, set the unit to turn on automatically at defined time intervals with the defined input source setting on the required days of the week. Press OK to open the Scheduler Settings menu screen. Set up to four different schedulers. Highlight the first checkbox of to the required scheduler option and check it by pressing the OK button. Define a time for the display to be turned on automatically. Highlight the time box next to the first checkbox and press the OK button, use the directional and numeric buttons on the remote to set a time. Press the OK button again when done.</p> <p>Perform the same steps to set a time for the Display to turn off.</p> <p>Define a source for your scheduler. Highlight the box located under the Source tab for your scheduler option and press the OK button, then set as required using the Left/Right directional buttons. If the Source option is set as Last Source, the input source is not changed at the power-up. If the Source option is set as USB, the media files in the connected USB device is played back automatically as explained in the section entitled USB Auto Play Feature.</p> <p>Select the week day(s) for your scheduler setting to be activated. Highlight the checkbox under the required day tab and press OK to check. Highlight and press OK a second time to uncheck a box. The scheduler is active on the checked days of the week.</p> <p>Press the Green button to save settings when complete.</p>

<p>Link Options</p>	<p>Press OK to open the link options menu screen. Current Start URL and Settings URL links is displayed. These items are for information only and not selectable. Refer to Usage of the Start URL section for information on setting the Start URL. Open browser initial page and NTP server link preferences can be configured using the related options.</p>
<p>Volume Settings</p>	<p>Press OK to see available menu options.</p>
<p>Reset to default values</p>	<p>Highlight this option and press the OK button on the remote to return the Display to default settings.</p>
<p>First Time Installation</p>	<p>Highlight and press OK to perform First Time Installation and reset all settings to factory settings. Enter the correct PIN to carry out this operation. Note: Enter the PIN you have defined during the First Time Installation process.</p>

System Menu Content

Language	Sets the OSD menu language preference.
Date / Time	Sets date and time.
Sources	Enables or disables selected source options. Regular, Enhanced and Disabled options are available for HDMI sources, if the display supports Ultra HD. Regular and Enhanced options are affecting the colour settings of the selected HDMI source. To watch 4K images from an HDMI source, the related source setting must be set as Enhanced if the connected device is HDMI 2.0 compatible. Set as Regular if the connected device is HDMI 1.4 compatible. Set accordingly or disable the related HDMI source by setting as Disabled. Note: HDMI cables longer than 5 metres and not HDMI certified, can cause display problems.
More	Displays other setting options of the Display.
Menu Timeout	Changes timeout duration for menu screens.
Standby LED	Enables or disables the functionality of the standby led. If disabled, the led does not function.
Software Upgraed	Displays current software version. Press OK to see the upgrade options. Use these options to start a manual search for software updates and set your automatic scan preference.
Auto Display OFF	Sets the required time for the Display to automatically go into standby mode when not being operated.
Auto Video Sharing	Audio Video Sharing feature allows you to share files stored on your smartphone or tablet PC. If a compatible smartphone or tablet PC and the appropriate software is installed, you can share/play photos on your Display. For more information, refer to the sharing software instructions.
Videowall Settings	Press OK to open the Video Wall Settings menu screen. Video Wall Settings, Row Count, Column Count, Cell and Offset options are available.
CEC	With this setting enable and disable CEC functionality completely. Press Left or Right button to enable or disable the feature.
CEC Auto power on	This function allows the connected HDMI-CEC compatible device to turn on the Display and switch to its input source automatically. Press Left or Right button to enable or disable the feature.
Quick Standby	If this feature is enabled, the display can be turned on again with the RS232 and Lan commands if it is turned off through it. Press Left or Right button to enable or disable the feature.
DP Steam Setting (*)	Sets the DisplayPort stream type. MST and SST options are available. This menu item appears only when the input source is set to DP.
USB Auto Play	Sets your Display to start playing the media content installed on a removable device automatically. Refer to USB Auto Play Feature section for detailed information.

Troubleshooting

Learn about common issues and their solutions.

Understanding the LED status indicators

Identify the LED state flashing pattern and meaning.

Power LED Status	Status of the monitor
LED not lit	Power on
LED lit	Power off (Standby mode)
LED flashing (slow)	Scheduler active
LED flashing (fast)	Power up/down and software update

Wireless network not available

The wireless network does not appear in the list of available networks.

Resolution

- Ensure the display panel wireless connection is allowed through the network firewall.
- Try searching for wireless networks again.
- If the wireless network does not function properly, use the wired network.
- If the display panel does not function using the wired connection, check the modem and router.
- If the router does not have a problem, check the internet connection of your modem.

Related information

Connecting to a wired network (on page 19)

Connection is slow

The network connection to the display panel is slow.

Resolution

To get information on the internet service area, connection speed, signal quality, and other settings, refer to the wireless modem documentation.

Disruption during playback or slow reactions

While content is playing on the display panel, the video is disrupted or slow to play.

Resolution

- Ensure the display panels are at least three meters away from microwave ovens, mobile telephones, Bluetooth-enabled devices, or any other Wi-Fi compatible devices.
- Change the active channel on the WLAN router.

Internet connection not available

The display panel cannot connect to the internet.

Resolution

- Ensure the display panel wireless connection is allowed through the network firewall.
- The MAC address of the display panel is authenticated each time when connecting to the internet. If the MAC address of the computer or modem is permanently registered, it is possible that the display panel might not connect to the internet. Because the display panel has its own MAC address, the internet service provider cannot validate the MAC address of the display panel. For this reason, the display panel cannot connect to the internet.
Contact the internet service provider and request information on how to connect a different device, such as the display panel, to the internet.

Audio video sharing not working

Audio and video cannot be shared to the display panel.

Resolution

- Ensure the display panel wireless connection is allowed through the network firewall.
- The MAC address of the display panel is authenticated each time when connecting to the internet. If the MAC address of the computer or modem is permanently registered, it is possible that the display panel might not connect to the internet. Because the display panel has its own MAC address, the internet service provider cannot validate the MAC address of the display panel. For this reason, the display panel cannot connect to the internet.

Contact the internet service provider and request information on how to connect a different device, such as the display panel, to the internet.

Invalid domain

An invalid domain error is displayed when trying to share media.

Resolution

Prior to sharing any files in the media server program on the computer, ensure that an authorized username and password is used for logging in, and that the domain is active. If the domain is invalid, this might cause problems while browsing files in Audio Video Sharing mode.

Remote control does not work

Using the remote control has no impact on the display panel.

Resolution

For remote control commands to be received by the display panel, the IR extender cable must be installed.

In certain conditions, direct light may impact the ability for the IR receiver to identify commands from the remote control.

Image has artifacts or judder

On the UHD982-P display panel, on certain resolutions the image may contain artifacts or judder.

Resolution

To resolve the issue, do one of the following.

- Navigate to **System > Picture Menu** and set the mode to either **Sports** or **Game**.
- Navigate to **System > Picture Menu > Advanced Settings** and turn off **Movie Sense**.

These settings may introduce judder into the image.

Specifications

Learn about the product specifications. Due to continuing research, specifications are subject to change without notice.

Physical specifications

Learn the physical specifications for the tiles and the power supply.

LCD Model	Dimensions (W x H x D)	Weight
UHD552-L	1238mm x 712mm x 104mm	17 Kg
UHD652-L	1459mm x 841mm x 99mm	25,25 Kg
UHD752-L	1684mm x 967mm x 100mm	37,25 Kg
UHD862-L	1972mm x 1143mm x 103mm	65,25 Kg

VESA Wall Mount Measurements

	Hole pattern size	Screw thread size	Screw thread size
UHD552-L	400 x 200	M6	9,5x21mm
UHD652-L	400 x 400	M6	7x21mm
UHD752-L	600 x 400	M8	15mm
UHD862-L	600 x 400	M8	15mm

Power specifications

Learn the power requirements for the display panels.

LCD Model	Input Rating
UHD552-L	100-240V AC 50-60Hz 1.4A
UHD652-L	100-240V AC 50-60Hz 1.8A
UHD752-L	100-240V AC 50-60Hz 3.1A
UHD862-L	100-240V AC 50-60Hz 3.8A

Environmental specifications

Learn the environmental specifications for the display panels.

Non-operating environment

LCD Model	Temperature	Humidity
UHD552-L	-20 °C to 60 °C (-4 °F - 140 °F)	(No condensation)
UHD652-L	-20 °C to 60 °C (-4 °F - 140 °F)	(No condensation)
UHD752-L	-20 °C to 60 °C (-4 °F - 140 °F)	(No condensation)
UHD862-L	-20 °C to 60 °C (-4 °F - 140 °F)	(No condensation)

Operating environment

LCD Model	Temperature	Humidity
UHD552-L	0 °C to 40 °C (32 °F - 104 °F)	(No condensation)
UHD652-L	0 °C to 40 °C (32 °F - 104 °F)	(No condensation)
UHD752-L	0 °C to 40 °C (32 °F - 104 °F)	(No condensation)
UHD862-L	0 °C to 40 °C (32 °F - 104 °F)	(No condensation)

The requirements for any country may change at any time. It is recommended that users check with local authorities for the current status of their national regulations for both 2.4 GHz and 5GHz wireless LANs.

Regulatory

This product conforms to the latest regulations and standards related to product safety, environmental, and electromagnetic compatibility (EMC) requirements.

Modification statement

Christie Digital Systems has not approved any changes or modifications to this device by the user. Any changes or modifications could void the user's authority to operate the equipment.

Christie Digital Systems n'approuve aucune modification apportée à l'appareil par l'utilisateur, quelle qu'en soit la nature. Tout changement ou modification peuvent annuler le droit d'utilisation de l'appareil par l'utilisateur.

Safety

- CAN/CSA C22.2 No. 62368-1:2014 – Audio/video, information and communication technology equipment – Part 1: Safety requirements
- ANSI/UL 62368-1:2014 – Audio/video, information and communication technology equipment – Part 1: Safety requirements
- IEC 62368-1:2014 / EN 62368-1:2014 + A11:2017 Audio/video, information and communication technology equipment – Part 1: Safety requirements
- EN 50663 : 2017

RF exposure

This equipment complies with FCC/ISED radiation exposure limits set forth for an uncontrolled environment and meets the FCC radio frequency (RF) Exposure Guidelines and RSS-102 of the ISED radio frequency (RF) Exposure rules. This equipment has very low levels of RF energy that is deemed to comply without maximum permissive exposure evaluation (MPE).

This device complies with Part 15 of the FCC Rules and Innovation, Science and Economic Development Canada license-exempt RSS standard(s). Operation is subject to the following two conditions: (1) this device may not cause interference, and (2) this device must accept any interference, including interference that may cause undesired operation of the device.

Подтверждение соответствия Минкомсвязи России: Декларация соответствия № Д-ИВРД-5325, Д-ИВРД-5326, и Д-ИВРД-5327 от 10.04.2018 года, действительна до 10.04.2024 года, зарегистрирована в Федеральном агентстве связи 17.04.2018

Electro-magnetic compatibility

Emissions

- CISPR 32/EN 55032
- FCC CFR47, Part 15, Subpart B, Class B – Unintentional Radiators
- ICES-003 (A), ISSUE 5, Class B Canada : RSS-102 and RSS-247

- IEC 61000-3-2/EN61000-3-2: Limits for Harmonic Current Emissions
- FCC CFR47, Part 15, Subpart C – Intentional Radiators

Immunity

- IEC 61000-3-3/EN61000-3-3
- IEC/EN61000
- IEC 61000-4-2/EN61000-4-2
- IEC 61000-4-3/EN61000-4-3
- IEC 61000-4-4/EN61000-4-4
- IEC 61000-4-5/EN61000-4-5
- IEC 61000-4-6/EN61000-4-6
- IEC 61000-4-11/EN61000-4-11

Environmental

China Ministry of Information Industry (along with 7 other Government Agencies) Order No.32 (01/2016) on the control of pollution caused by electronic information products, hazardous substances concentration limits (GB/T 26572 - 2011), and the applicable product marking requirement (SJ/T 11364 - 2014).

EU Directive (2011/65/EU) on the restriction of the uses of certain hazardous substances (RoHS) in electrical and electronic equipment and the applicable official amendment(s).

EU Directive (2012/19/EU) on waste and electrical and electronic equipment (WEEE) and the applicable official amendment(s).

Regulation (EC) No. 1907/2006 on the registration, evaluation, authorization and restriction of chemicals (REACH) and the applicable official amendment(s).

Certification Note for Canada

This device contains licence-exempt transmitter(s)/receiver(s) that comply with Innovation, Science and Economic Development Canada's licence-exempt RSS(s).

Operation is subject to the following two conditions,

1. This device may not cause interference.
2. This device must accept any interference, including interference that may cause undesired operation of the device.

L'émetteur/récepteur exempt de licence contenu dans le présent appareil est conforme aux CNR d'Innovation, sciences et Développement économique Canada applicables aux appareils radio exempts de licence. L'exploitation est autorisée aux deux conditions suivantes:

1. L'appareil ne doit pas produire de brouillage;
2. L'appareil doit accepter tout brouillage radioélectrique subi, même si le brouillage est susceptible d'en compromettre le fonctionnement.

Corporate offices

Christie Digital Systems USA, Inc.
Cypress
ph: 714 236 8610

Christie Digital Systems Canada Inc.
Kitchener
ph: 519 744 8005

Worldwide offices

Australia
ph: +61 (0) 7 3624 4888

Brazil
ph: +55 (11) 2548 4753

China (Beijing)
ph: +86 10 6561 0240

China (Shanghai)
ph: +86 21 6278 7708

France
ph: +33 (0) 1 41 21 44 04

Germany
ph: +49 2161 664540

India
ph: +91 (080) 6708 9999

Japan (Tokyo)
ph: 81 3 3599 7481

Korea (Seoul)
ph: +82 2 702 1601

Mexico
ph: +52 55 4744 1790

Republic of South Africa
ph: +27 (0)11 510 0094

Russian Federation
and Eastern Europe
ph: +36 (0) 1 47 48 100

Singapore
ph: +65 6877 8737

Spain
ph: +34 91 633 9990

United Arab Emirates
ph: +971 4 3206688

United Kingdom
ph: +44 (0) 118 977 8000

United States (Arizona)
ph: 602 943 5700

United States (New York)
ph: 646 779 2014

Independent sales consultant offices

Italy
ph: +39 (0) 2 9902 1161



For the most current technical documentation, visit www.christiedigital.com.

