



User Manual

020-001698-01

# Projector Messenger Tool

Ver. 1.50

**CHRISTIE**

# Content

- 1 Introduction.....4**
  - 1.1 Outline ..... 4
  - 1.2 System ..... 5
- 2 Installation.....6**
  - 2.1 System Requirements ..... 6
- 3 Function.....7**
  - 3.1 Abstract ..... 7
  - 3.2 Supported language..... 9
  - 3.3 Each part name ..... 10
  - 3.4 Display style ..... 12
  - 3.5 Display mode ..... 13
  - 3.6 Display position ..... 14
  - 3.7 Title icon ..... 15
  - 3.8 Character font size..... 15
  - 3.9 Character color..... 16
  - 3.10 Character limit ..... 17
  - 3.11 Level ..... 18
  - 3.12 Startup Display..... 19
  - 3.13 Caution ..... 19
- 4 Alarm.....20**
  - 4.1 Outline ..... 20
- 5 Install.....22**
  - 5.1 Projector Messenger Tool Installation ..... 22
- 6 Operating Instructions.....24**
  - 6.1 Start Application..... 24
  - 6.2 Quit Application ..... 24
  - 6.3 Main Screen..... 25
  - 6.4 Select Projector ..... 26
  - 6.5 Projector Status ..... 27
  - 6.6 Send Message ..... 27
  - 6.7 Display on/off ..... 28

6.8 Delete Message .....	29
6.9 Create Projector List .....	30
6.10 Create Message .....	32
6.11 Send Message .....	37
6.12 Save File.....	38
6.13 Get Message .....	38
6.14 Startup Display.....	39
6.15 Send Lock.....	40
6.16 About this Application.....	44

- Microsoft and Windows is the registered trademark of Microsoft Corporation in the US and other countries.
- Pentium is the registered trademark of Intel Corporation in the US and other countries.
- All other trademarks are the property of their respected owners.

## Warning

- This software is free. The manufacturer has no responsibility for any errors that may occur while using this software.
- This software, or any product used with this software may not be used for any act which obstructs the Maintenance of the International Peace and Safety.

# 1 Introduction

## 1.1 Outline

Projector Messenger Tool is application software used when the messenger function is used with the projector.

PJMessenger provides the ability to:

- ✗ The message edited in the editor is transmitted to the projector by way of the network and it preserves it.
- ✗ Display On/Off and the deletion of the message registered in the projector are executed.
- ✗ The alarm registered in the projector is played in sync with the message.
- ✗ The message data send button can be locked using a password.

[Note]

In order to send the Message to the projector, the computer needs to connect the network and be able to communicate with the projector. Please see 'User's Manual-Network Functions' for the details.

Please see 'User's Manual-Operating Guide' and 'User's Manual-Network Functions' about Messenger functionality.

## 1.2 System

The following diagram shows a typical network diagram for the Projector Messenger Tool.

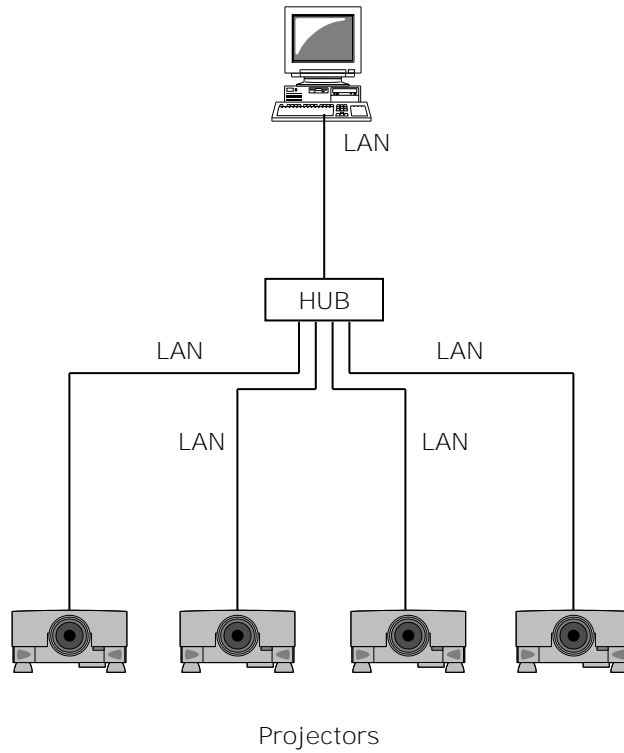

- Use a UTP cable category 5 or higher for a Local Area Network cable.

# 2 Installation

## 2.1 System Requirements

The following are the minimum system requirements of hardware and software to use the Projector Messenger Tool

(1) Operating System

Windows 7

Windows 8

Windows 8.1

Windows 10

(2) CPU

Pentium3 500MHz or higher

(3) Memory

128MB or higher

(4) Hard Disc

Minimum 20MB free space for installation.

(5) Local Area Network port (RJ-45)

# 3 Function

## 3.1 Abstract

The messenger function is the one to transmit the message (text data) to the projector by way of the network, and display the character data transmitted on the screen of the projector.

【Image】



The display style can be selected from 3 styles (Scroll / Box / Pop on).  
Please refer to the following for each detail.

### 1) Scroll

The message text is displayed by a horizontal scroll.

It is suitable for reducing the influence on the image displayed or the display of short sentences.

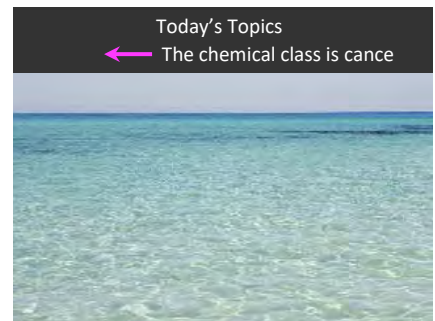

## 2) Box

The message text is displayed by a vertical scroll.

It is suitable for the display of long sentences.

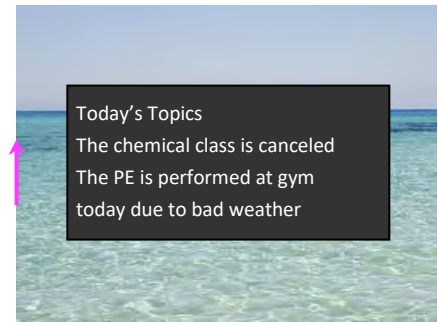

## 3) Pop on

The message text is popped on the screen all at once. The blinking operation is possible though there is no movement such as scrolls.

It is suitable for the display of sentences to want to pay attention.

(etc. alarm)

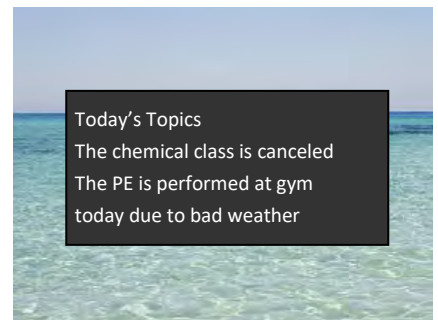

## 4) Picture Side

This function is only available for wide aspect ratio panel models. When not native aspect signal such as 4:3 is input to wide aspect ratio panel models, right and left hand sides are non-image display area. The message text is displayed in this non-image display area. In this case, displayed image can be shifted to right or left hand side.

If you select text display at left hand side, image display moves to right hand side. On the other hand, right hand side is selected for text display, image display moves to left hand side.

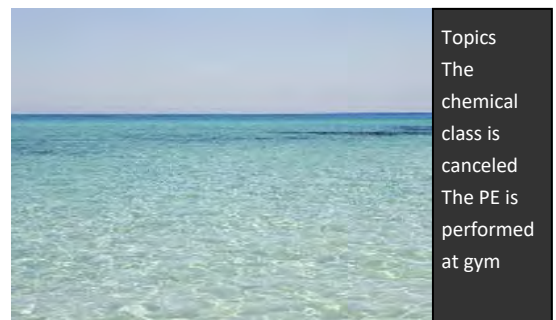
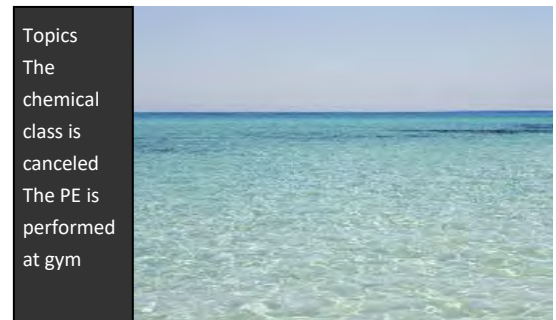



## 3.2 Supported language

The example of the language that can be displayed is shown below.

e.g. English, French, German, Spanish, Italian, Norwegian, Dutch, Portuguese, Swedish, Finnish, Polish, Russian, Turkish, Japanese, Chinese (Simplified), Chinese (Traditional), Korean.

### 3.3 Each part name

The name of each part is defined as follows.

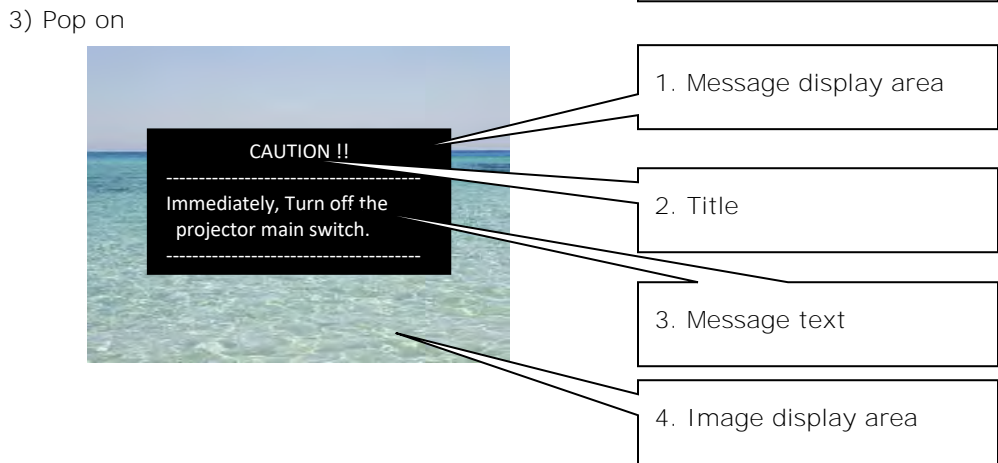
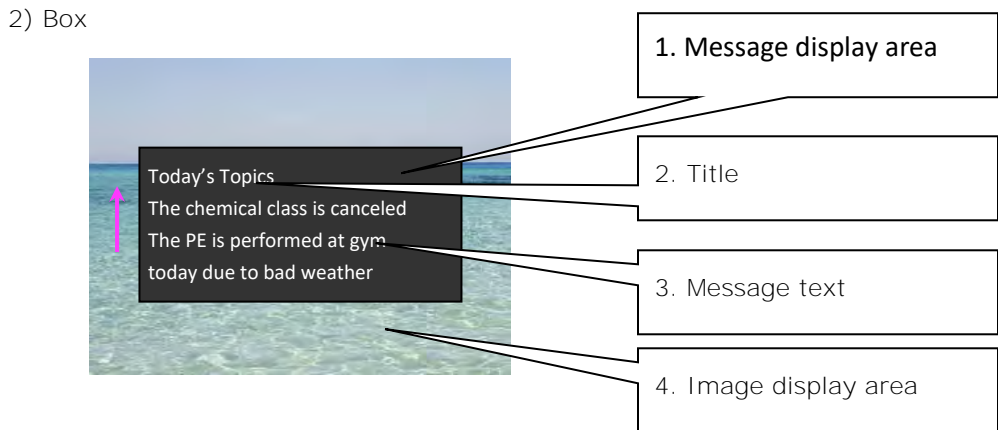
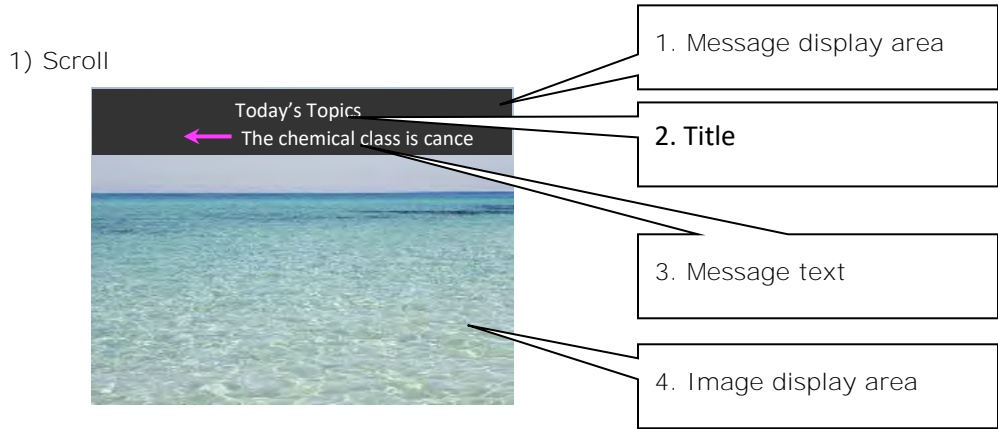

## 4) Picture Side

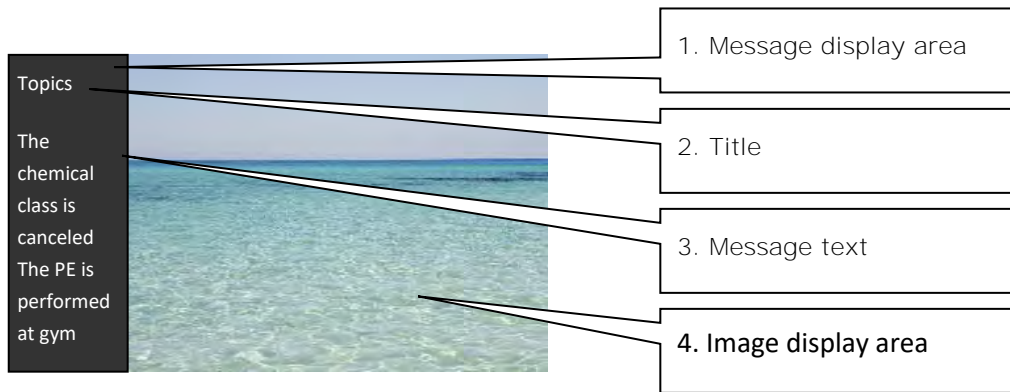

### 1. Message display area

It is an area where the message is displayed. The color can be set. Please refer to "3.9 Character color" for details.

### 2. Title

The title of the displayed message is displayed. The title is displayed by a line. Moreover, the character color and the character background color can be set. Please refer to "3.9 Character color" for details.

### 3. Message Text

The text of the message is displayed. The character color and the character background color can be set. Please refer to "3.9 Character color" for details.

### 4. Image display area

It is an area where the image is displayed.

## 3.4 Display style

The display style can be selected from 3 styles (Scroll / Box / Pop on). Please refer to the following for each detail.

### 1) Scroll

The title is displayed in the first line, and the message text is displayed in the second line.

Only the message text scrolls to the left. The title doesn't scroll.

Only the message text is displayed by one line when there is no title.

It is also possible to set the scroll times, and to turn off the display by the automatic operation. Moreover, it is also possible to set the speed of the scroll from 3 types (slow/standard/fast).

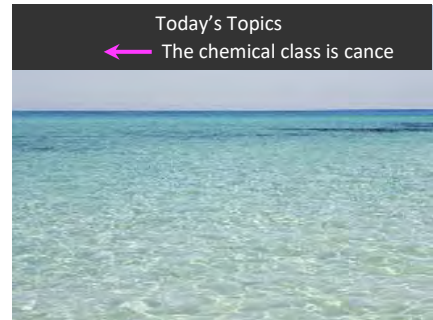

### 2) Box (Scroll up)

The title is displayed in the first line. The character scrolls in the message display area. Even if the screen changes by the vertical scroll of the message text, the title is always displayed.

The display time can be set, and the display be turned off by the automatic operation.

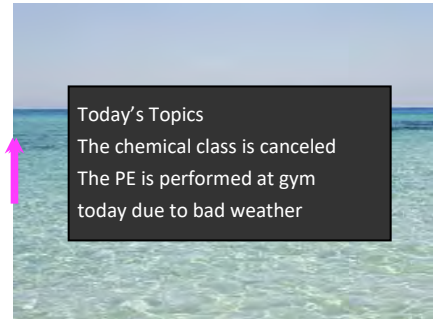

### 3) Pop on

The title and the message text are displayed all at once.

The title is displayed in the first line. The message text is not scrolled.

The display time can be set, and the display be turned off by the automatic operation.

Moreover, the blink setting can be set. When the blink setting is turned on, the interval is [1 second: non-display / 3 seconds: display].



## 4) Picture Side

The title is displayed in the first line. The character scrolls in the message display area. Even if the screen changes by the vertical scroll of the message text, the title is always displayed.

Depending on the combination with input signal aspect ratio, "Picture Side" texts might be displayed over the image. In that case, you can make "Picture Side" invisible. Push "down ▼" button on remote or select "down ▼" in OSD while "Picture Side" is displayed.

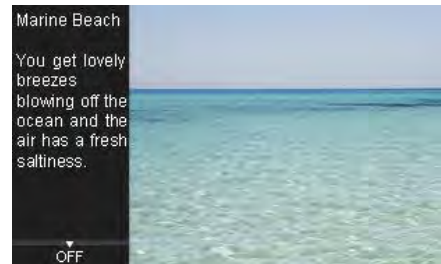

[Note]

When Picture Side function is enabled, the title will not be displayed completely depending upon the length of title or other projector settings.

## 3.5 Display mode

### 1) Quick

It immediately displays transmitted message without saving the message data. When AC is turned off, the message data is deleted. (It is not deleted when the projector stays in the standby mode.)

### 2) Saved number

The message is saved in the memory in the projector. 12 pieces can be saved.

Even if the main power is turned off, the message is not deleted.

Therefore, it makes possible to display the message only by setting saved number.

## 3.6 Display position

1) Horizontal position (Scroll / Box / Pop on)

A horizontal position of the "Title" can be selected from 3 styles (left/center/right). The position cannot be chosen about the "Message text".



2) Vertical position (Scroll)

The vertical position can be selected from 3 styles (upper/center/lower).

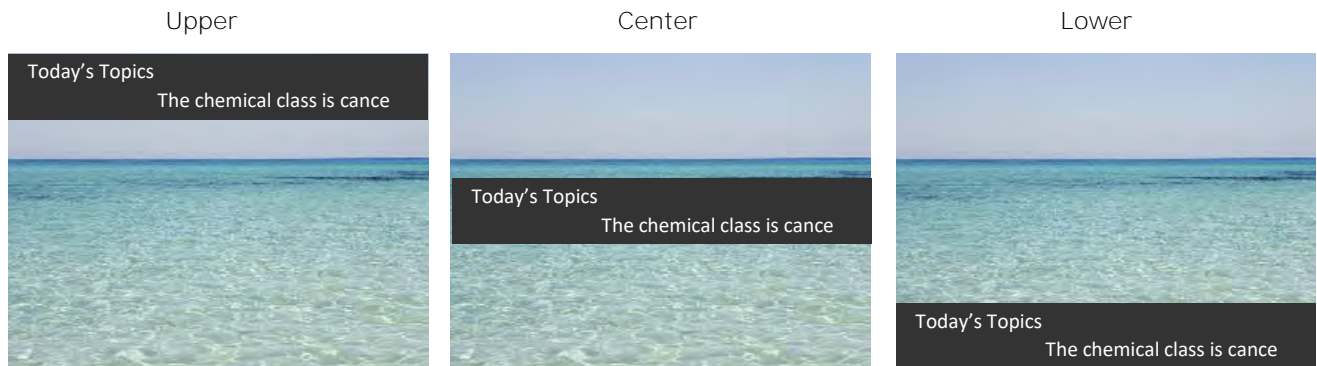

3) Vertical position (Box/Pop on)

The vertical position can be selected from 3 styles (upper/center/lower).

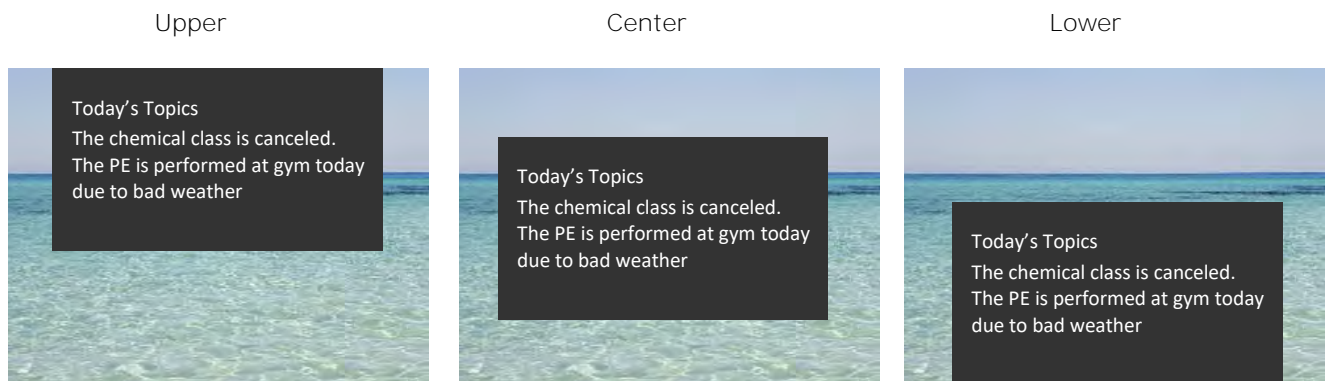

#### 4) Horizontal position (Picture Side)

The Horizontal position can be selected from 2 styles (Left/Right).



### 3.7 Title icon

The icon can be inserted in the title.

Please select it from the following five icons.

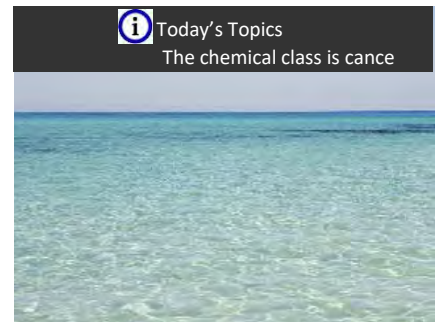
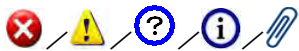

### 3.8 Character font size

The character font size to display can be chosen from two, Standard/Double size.

## 3.9 Character color

The character color, the character background color, and the background color can respectively be chosen according to the following nine colors.

Black / Red / Blue / Green / Cyan / Magenta / Yellow / White / Half transparent black

It is possible to color in each character. (character color and character background color)

The background color sets the color of the message display area. The background color of the title and the message text becomes the same color.

The example of the scrolling display is shown right.

[Character color: Red / Character background color: Blue / Background color: Green]

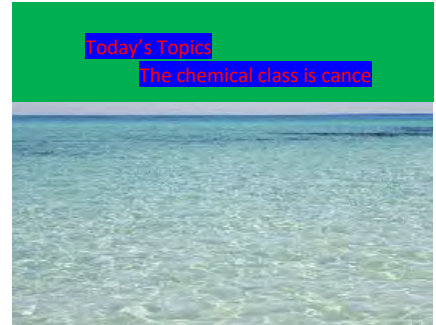



## 3.10 Character limit

### 1) Title

Max 40 characters can be input by a standard character font size, and Max 20 characters can be input by a double character font size.

[Note]

- The data of 128 bytes is the maximum in the title. When character color/character background color is set, the data for color information will be added further. Therefore, when the character color is set, it becomes less than 40/20 characters. Please refer to the following \* character data computational method for the data size of message computational method.
- When Picture Side function is enabled, the title will not be displayed completely depending upon the length of title or other projector settings.

### 2) Message text

The data of 3968 bytes is the maximum in message text. When character color/character background color is set, the data for color information will be added further. It is 1916 characters or less when only one color is used, but it decreases less than 1916 characters when the character color is set. Please refer to the following \* character data computational method for the data size of message computational method.

<Character data calculate method example>

First of all, control header (6byte) that includes color information in beginning is added. Afterwards, the character code (Unicode) continues. And then if the character color is changed, control header (6byte) is added in addition. The terminate code (2byte) is added to the terminal of the message, and it becomes an end of the message data.

The example of calculating the data size is shown below (when "Today" is input).

Ex 1) Today (all black characters with white background)

Control code	Character color(Black)	Character background color(White)	'T'	'o'	'd'	'a'	'y'	Control Code
[00][1B]	[00][00]	[00][07]	[00][54]	[00][6F]	[00][64]	[00][61]	[00][79]	[00][00]

The data size is 18 bytes for example 1).

The next example when one character color is changed is shown below.

Ex 2) Today ("d" is only red character and remaining characters are all black with white background)

Control code	Character color(Black)	Character background color(White)	'T'	'o'	Control code	Character color(Red)	Character background color(White)	'd'
[00][1B]	[00][00]	[00][07]	[00][54]	[00][6F]	[00][1B]	[00][01]	[00][07]	[00][64]

Continues to the next line. →

Continuation from the former line →

Control code	Character color(Black)	Character background color(White)	'a'	'y'	Control code
[00][1B]	[00][00]	[00][07]	[00][61]	[00][79]	[00][00]

The data size is 30 bytes for example 2).

As mentioned above, 12byte (control header 6byte×2) data size will increase when the character color is changed only by one character.

### 3.11 Level

The projector displays the NO INPUT IS DETECTED message (hereafter, NO INPUT message) etc. displayed in the menu, the alarm message, and the state of non-input with OSD on the input image.

This is setting to decide the priority level of the display item.

The display level can be selected from 3 styles (low/middle/high).

Please refer to the following for each detail.

1) High: neither menu OSD nor the alert messages are displayed.

[Note]

There is no method of turning off the message except that the application software is used to turn off the message when Messenger is not set with My Button. Please refer to the projector manual attachment for the setting of My Button.

While the message set at High-level is displayed, all buttons except STANDBY/ON button are invalid.

2) Middle: NO INPUT message is not displayed. Just the message is displayed.

3) Low: After the NO INPUT message is displayed for five seconds, the message is displayed.

## 3.12 Startup Display

In specified minutes after AC is turned on or return from stand-by mode, stored message in projector memory is displayed. This function is not available at "Quick" display mode. You can select the display message from 12 stored ones by "Saved number" as described in "3.4 Display mode".

You can also set this function at the same time when you newly send the message to projector or store into projector.

## 3.13 Caution

1) This messenger function and C.C functions cannot be used at the same time. Please turn off the message to display C.C because the priority of the message is set high.

2) When direct keys such as Magnify, Freeze, and Position are operated while this function is used, it becomes invalid. Please turn off the message when using it.

# 4 Alarm

## 4.1 Outline

The Alarm function is the one to sound the alarm at the same time when the message transmitted by way of the network is displayed with the projector.

Please use this function when you want to display the message that you want to show particular attention to. These alarms can be selected from four types of alarm registered in projectors.



The following is the alarms registered in projectors.

- 1) Sound Number 1 [ The alarm sound : pipipipi... ]
- 2) Sound Number 2 [ The warning sound : beee... ]
- 3) Sound Number 3 [ The start-up sound : poon]
- 4) Sound Number 4 [ The campus broadcasting sound : Pin – Pon – Pan - Pon]

Moreover, it is possible to set following option to these above alarm.

1) Volume [low/mid/high]

The volume of the alarm can be selected from low/mid/high.

[Note]

This volume is not synchronized with the volume of the projector. Please note it.

Even if you mute the projector, these alarms is played by the specified volume.

2) Loop [endless/1/3/5]

The alarm time is selected from endless/1/3/5.

3) Interval [0-5sec]

Time from the end of the alarm the next alarm can be selected.

You can select from 0 second to 5 second.

# 5 Install

## 5.1 Projector Messenger Tool Installation

The installation process of Projector Messenger Tool is as shown below. Please follow each step.

(1) Double click the file "InstForPJMessenger\_v1.50.exe".

(2) Click [Next]

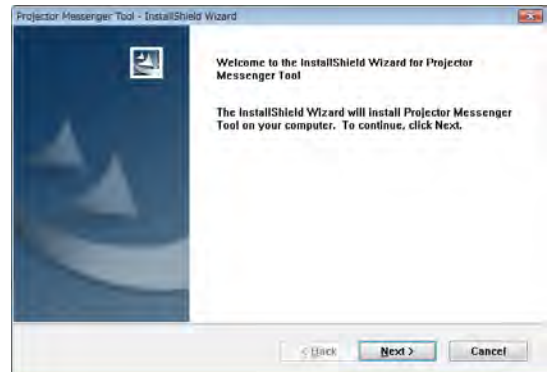

(3) Read "License Agreement" and select "I accept the terms of the license agreement" and click [Next] if you agree the license agreement. Otherwise, click [Cancel] and stop the installation.

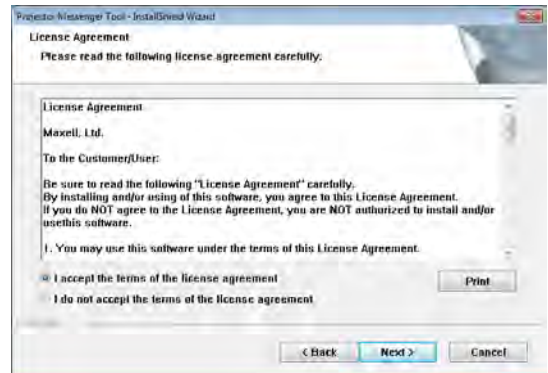

(4) Confirm the program folder, and then click [Next].

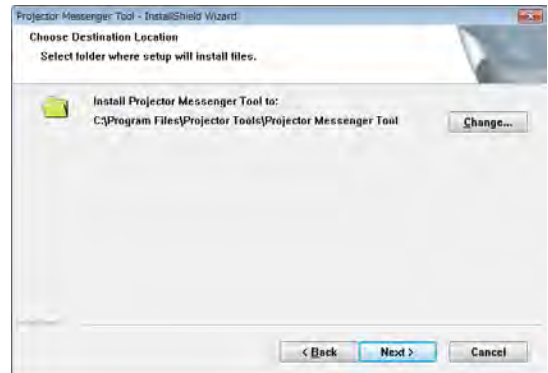

(5) Confirm the install folder and program folder again, and then click [Next].

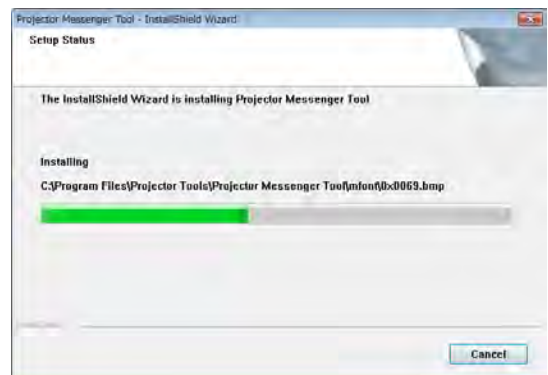
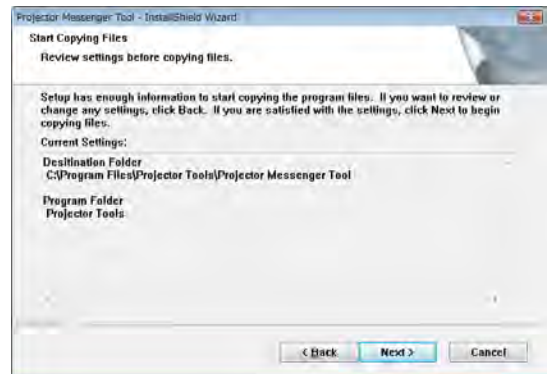
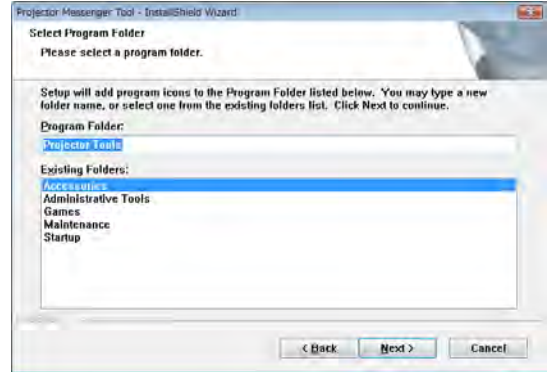

(6) Click [Finish] to complete the Projector Messenger Tool setup wizard.

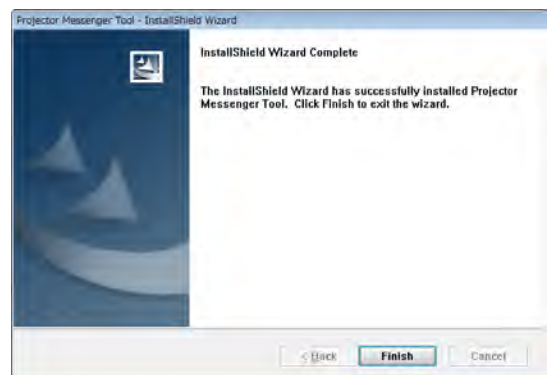

# 6 Operating Instructions

## 6.1 Start Application

Select Windows [Start] → [Program] → [Projector Tools] → [Projector Messenger Tool]. A following window is appeared.

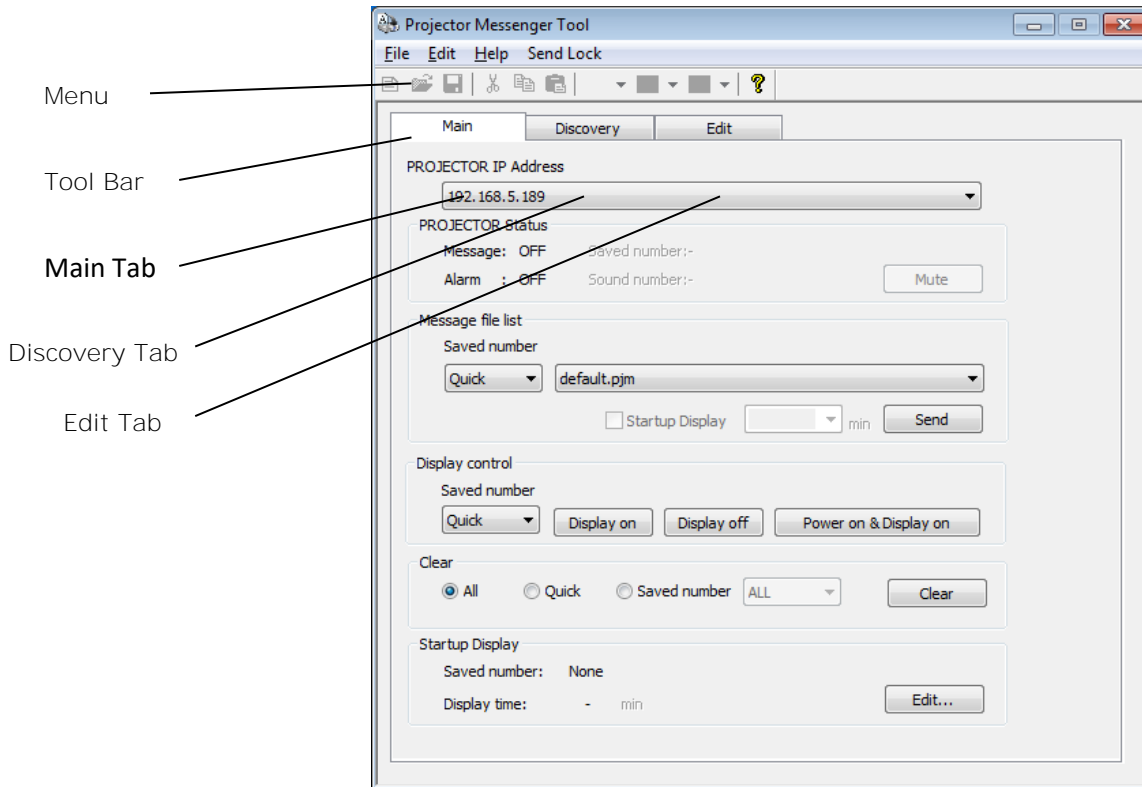

## 6.2 Quit Application

Select [File] - [Exit] to quit.

It is also possible to quit this software by clicking [x] on the top right corner of the window.

When the confirmation dialog appears, select [OK] to finish.

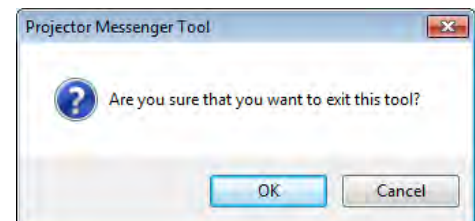



## 6.3 Main Screen











### (1) Menu

The functions of the main window are as follows.

Menu	Sub-Menu	Function
File	New	The message/title boxes are initialized.
	Open	Load the image file from the PC and display it on Main Screen.
	Save	Save the image file on Main Screen as a Projector GIF type.
	Exit	Quit Application.
Edit	Undo	Undo a previous change.
	Cut	Selected sentences are cut.
	Copy	Selected sentences are copied.
	Paste	Sentences of the clipboard are pasted.
	Font color	The character color is decided, and it colors.
	Font background color	The character background color is decided, and it colors.
	Background Color	The background color is decided, and it colors.
Help	About	Display the version of this application.
Send Lock	Send Lock	The password lock on the Send button of the Main tab and the Edit tab.
	UnLock	Release the lock on the send button of the Main tab and the Edit tab is released.
	Change Password	Change the password used to lock the Send button of Main tab and the Edit tab.

(2) Toolbar

The functions of these icons correspond with the menus are as follows:

Icon	Menu
	[File] – [New]
	[File] – [Open]
	[File] – [Save]
	[Edit] – [Cut]
	[Edit] – [Copy]
	[Edit] – [Paste]
	[Edit] – [Font color]
	[Edit] – [Font background color]
	[Edit] – [Background color]
	[Help] – [About]

## 6.4 Select Projector

The destination is selected from shown PROJECTOR IP Address.

In the initial state, "Please select PROJECTOR" is displayed in this list.

It is because of no registration in the initial state in the projector list. Please refer to "6.9 Create Projector List" for details of the registration of the projector list.

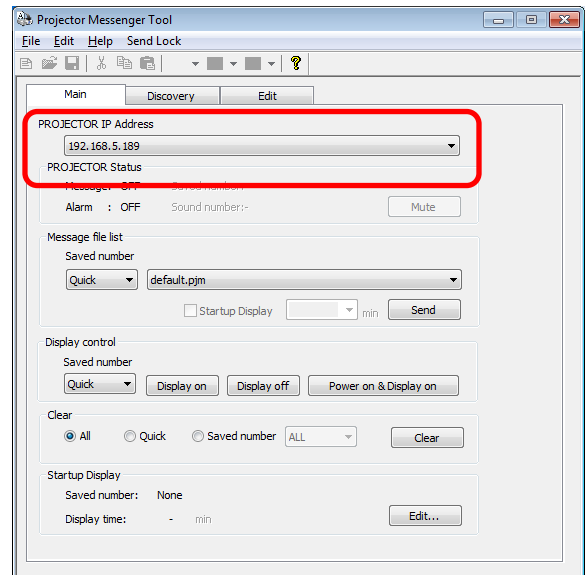

## 6.5 Projector Status

The state of the message and the alarm that selected in [PROJECTOR IP Address] on the projector are displayed in [PROJECTOR Status].

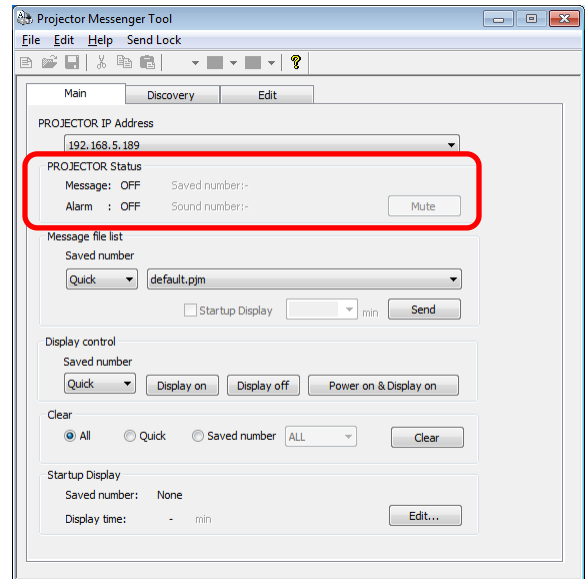

## 6.6 Send Message

The file and the saved number are selected in Message file list, and then click the Send button.

The .pjm file is made in the Edit tab. Please refer to “6.10 Create Message” for details.

You can also set “Startup Display” at the same time when you newly send the message. Please checked “Startup Display” and select the display time.

[Note]

“Startup Display” is not available at “Quick” display mode.

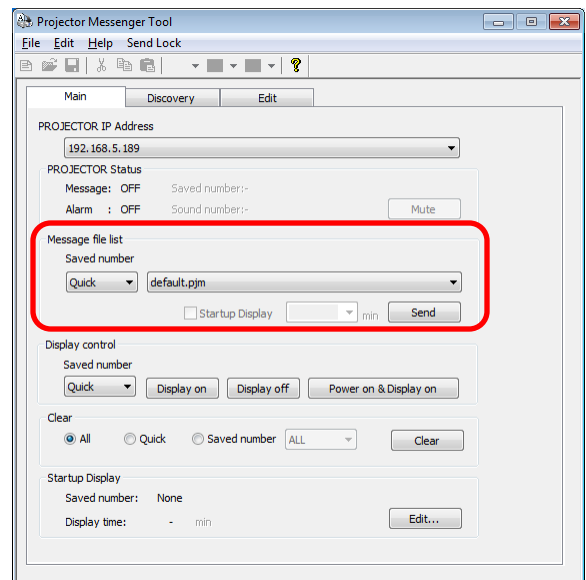

## 6.7 Display on/off

1) Please select the saved number, and click the Display on/off button in "Display control" when you want to display saved message in the projector.

2) To display high-priority text data, click the "Power on & Display on" button.

When the "Power on & Display on" button is clicked in on state, the message is displayed.

When the "Power on & Display on" button is clicked at the standby, the projector is turned on and then the message is displayed.

When the "Power on & Display on" button is clicked at the cooling, the power supply is automatically turned on after the cooling ends and then the message is displayed.

During the high-priority text data is being displayed, text display by the scheduling function will not start.

To turn off the high-priority text, click the "Display off" button or using MY BUTTON that registered MESSENGER.

Please refer to the manuals enclosed with projector for the setting of MY BUTTON and Schedule function.

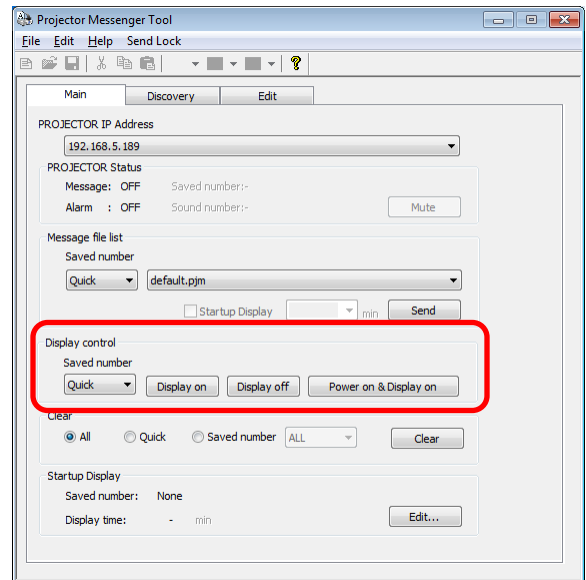

## 6.8 Delete Message

1) Please execute it from the Clear item as shown right to delete the message preserved in the projector.

All: Quick and all the saved data are deleted.

Quick: Only the Quick is deleted.

Saved Number: Only the saved number specified by the pull-down menu is deleted.

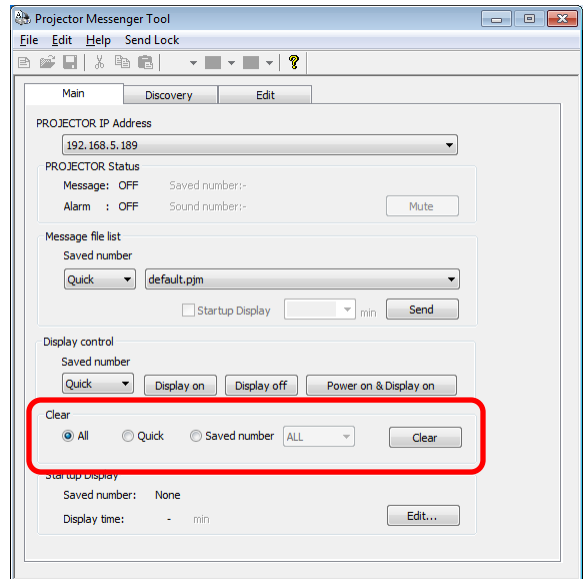

## 6.9 Create Projector List

1) When the Discovery tab is opened, the projectors connected with the network are displayed.

When the connected projector is not found, please click the Configuration Manually button. Please refer to 4) for details of the registration of the projector list.

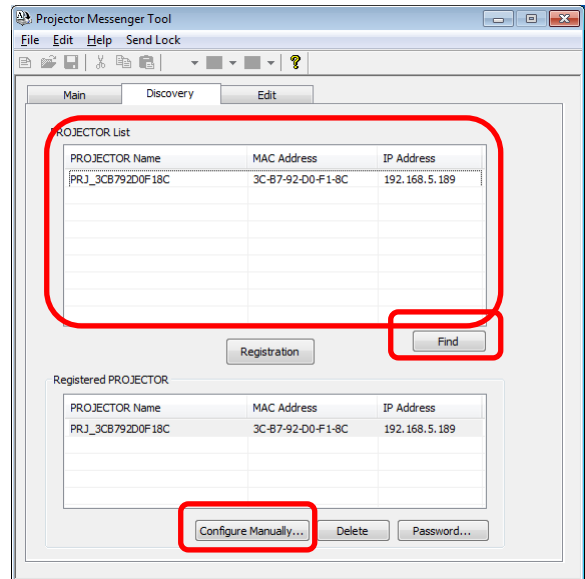

2) Please select the projector you want to register, and click the Registration button. It is displayed in Registered PROJECTOR.

3) When you want to delete a projector from the list, click the Delete button

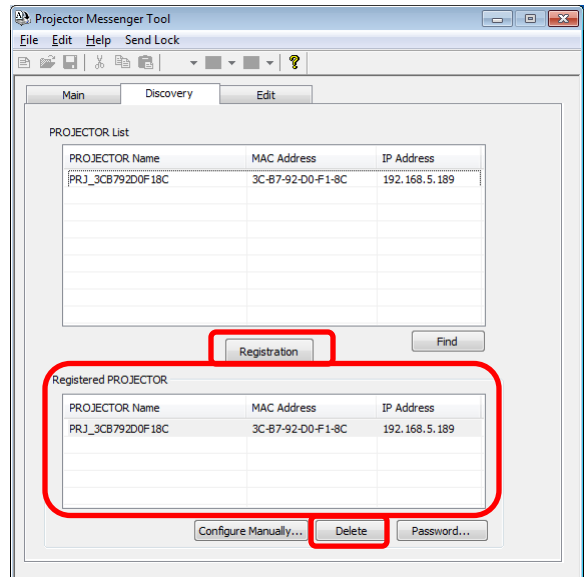

4) When manually register in the projector list, click the **“Configure Manually”** button.

The dialog as shown right is appeared.

Please input IP Address, Mac Address and the password, and then click OK.

It is registered in the list.

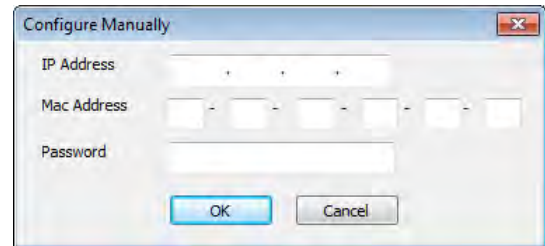
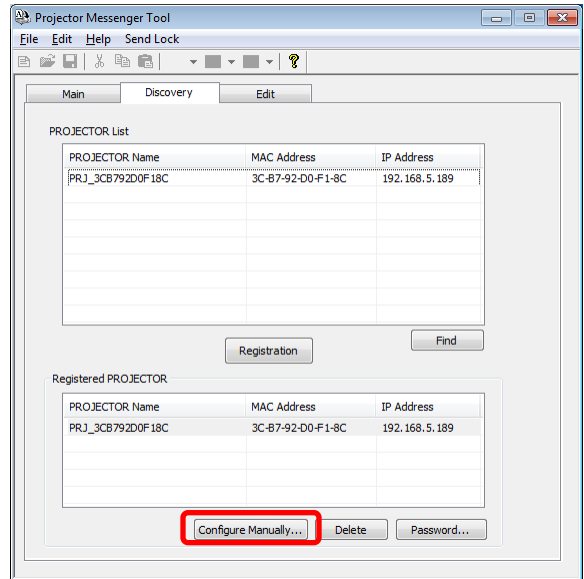

5) Authentication

Please click the projector you want to set the authentication password, and click the Password button. The window as shown right is appeared, and set the password.

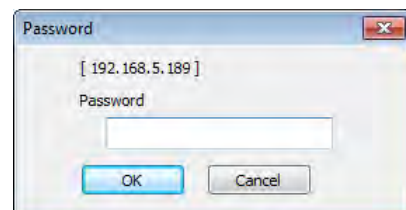
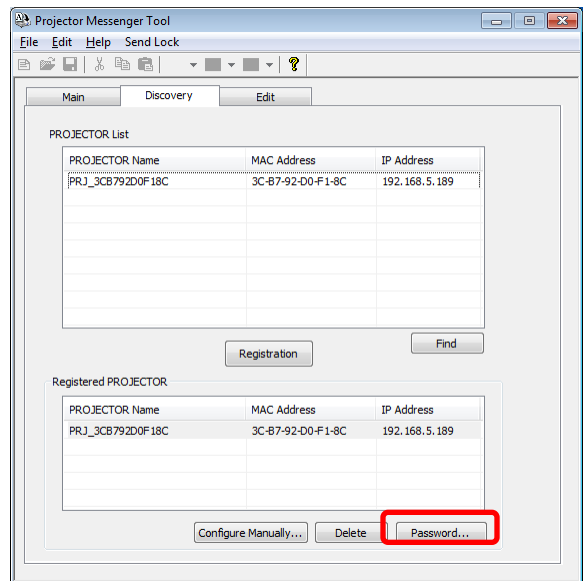

## 6.10 Create Message

### 1) Advanced Setting

Please click the Advanced button.

Advanced setting box is appeared.

Please refer to the following for each detail.

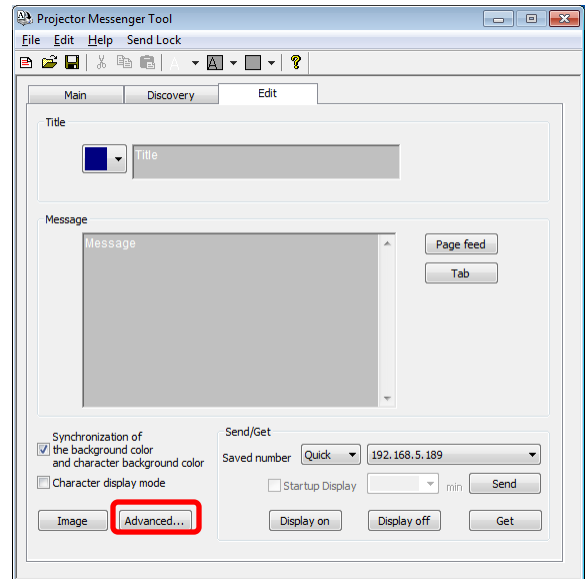

#### <Title Option>

Position: The position where the title is displayed is set.

You can select from Left/Center/Right.

#### <Message Option>

Style: The display style is selected.

You can select from Scroll/Box/Pop on/Picture Side.

**"Picture Side" can be selected only when wide aspect ratio (16:10) panel model is used.**

Scroll num: The scroll times is selected.

You can select from Repeat/0-100.

The direct input of the numerical value is also possible.

Scroll speed: The speed of the scroll is selected.

You can select from Slow/Standard/Fast.

Display time: The display time at Box/Pop on is selected.

min : Repeat/0-127min

sec : 0/30sec

The numerical value can be input directly for the item of min.

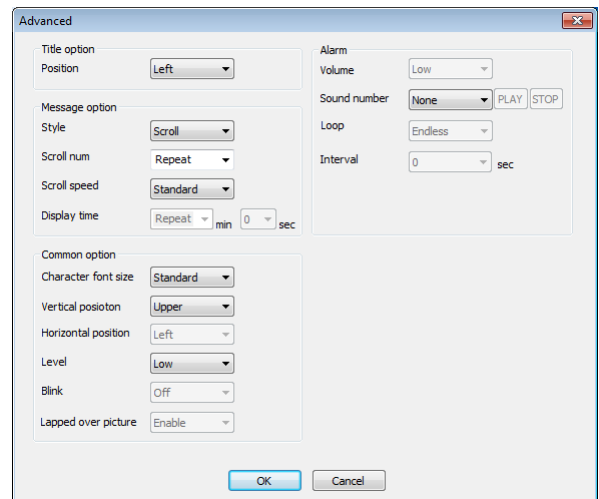



## <Common Option>

Character font size: The size of the displayed character is selected.

You can select from Standard/Double size.

Vertical position: The vertical display position is selected.

You can select from Upper/Center/Middle.

Horizontal position: The horizontal display position is selected.

You can select from Left/Right.

Level: The display level is selected.

You can select from Low/Middle/High.

Blink: It is set whether to do the blink when the Pop on display is selected.

You can select from On/Off.

Lapped over picture: It is set whether to display the message when "Picture Side" texts displayed over the image.

You can select from Enable/Disable.

## <Alarm>

Volume: The volume of the alarm is selected.

You can select from Standard/Double size.

Sound Number: The type of the alarm is selected.

You can select from [none/1/2/3/4].

Loop: The alarm time is selected.

You can select from [endless/1/2/3/4].

Interval: Time from the end of the alarm the next alarm can be selected.

You can select from 0 sec to 5 sec.

## 2) Create Message

When you want to color to the character, click the arrow button at the right of icon  after the character is dragged with the mouse and highlighted.

The color selection dialog is appeared. Please select the color, and click the OK button. Character/character background color can be set.

A right picture shows the character color of "ess" of "Message" is set as red and the character background color of "age" of "Message" is set as blue.

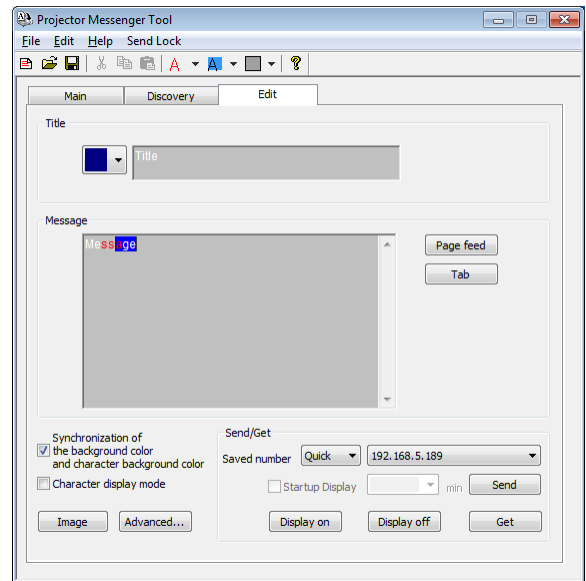
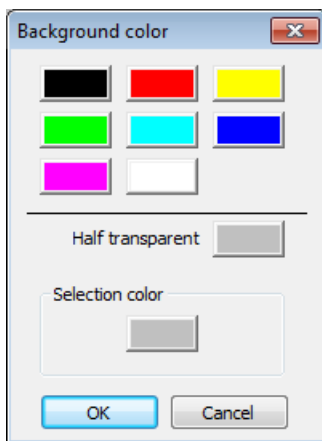

3) Preview

How the created message is displayed on the screen of the projector can be confirmed before it is sent.

Please click image button, then the image dialog is appeared.

The movement such as scroll can be confirmed.

[Note]

This feature is only available for the following models.

LX41, LW41, LW401, LWU421, LX501, LWU501i,

LW551i, LX601i

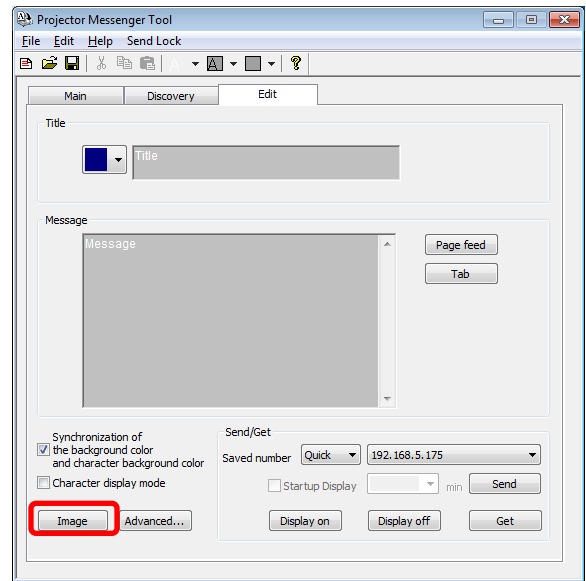

Style: Scroll

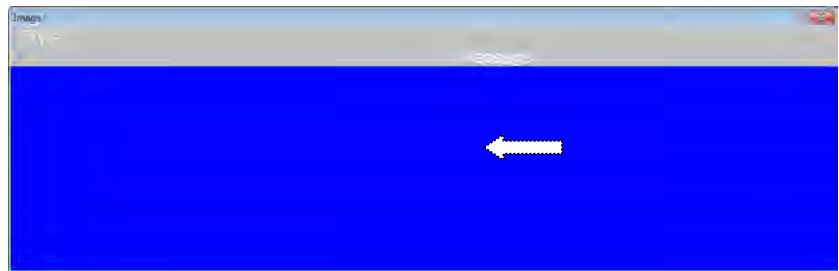

Style: Box/Pop on

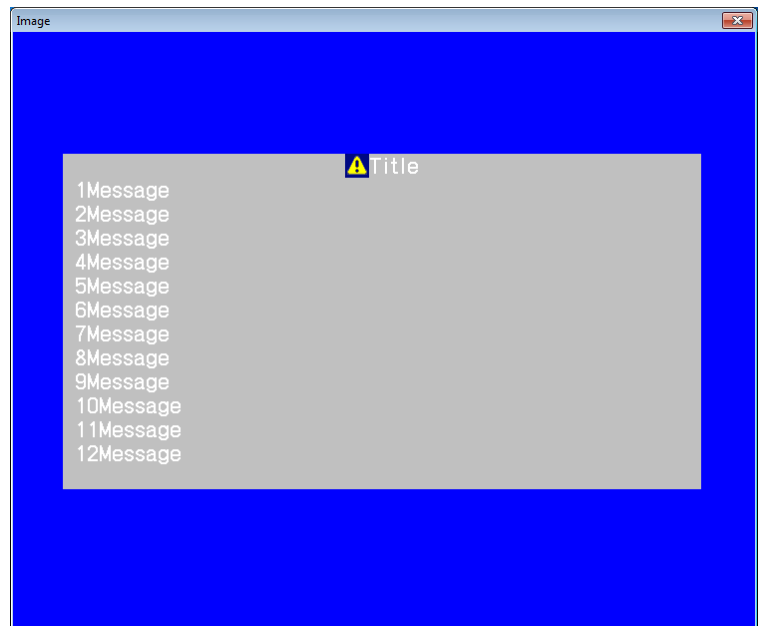

Style: Picture Side

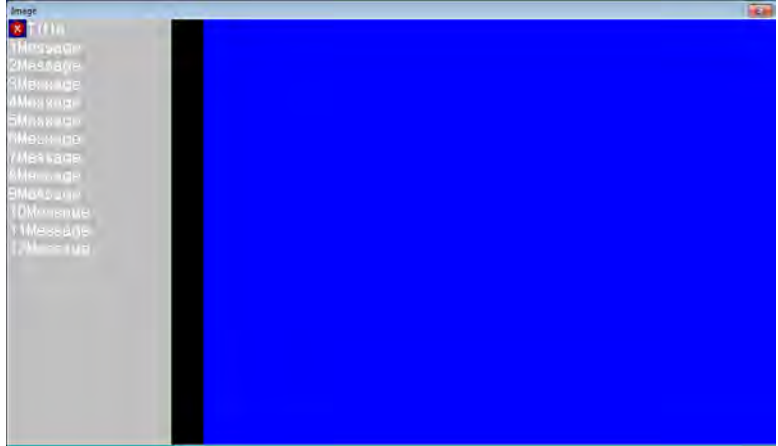

## 6.11 Send Message

Click Send button, and transmit the made message.

You can also set "Startup Display" at the same time when you newly send the message. Please checked "Startup Display" and select the display time.

[Note]

- "Startup Display" is not available at "Quick" display mode.
- When "Character Display Mode" is checked, character background color and background color is set transparent and then only the character is displayed on the screen.

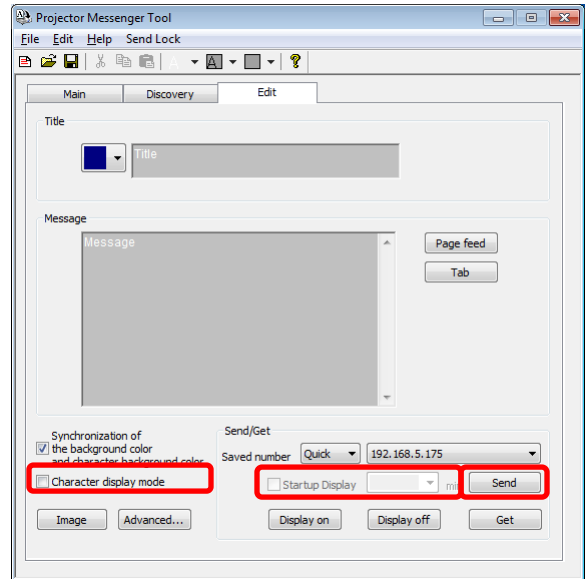

## 6.12 Save File

- (1) Select [File] → [Save] or click  :  
→ Save File dialog appears
- (2) Select the folder to save and enter the file name, and then Click [Save].  
→ The file is converted to a transmittable form and saved in the folder, and the screen is closed.

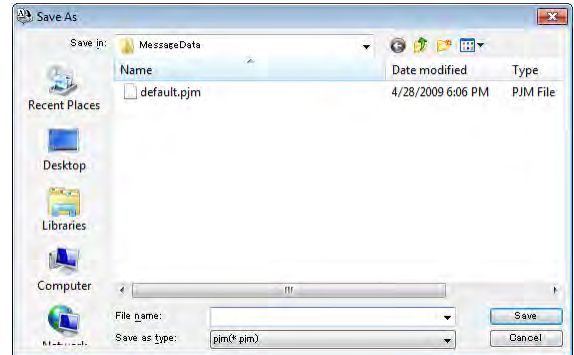

## 6.13 Get Message

When you want to get the message data that saved in the projector, designate saved number and click Get button. The message saved in the projector is displayed on the Message box and Title box.

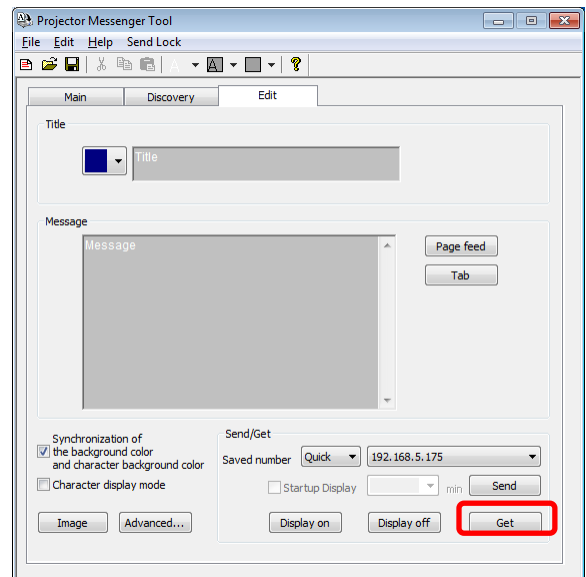

## 6.14 Startup Display

This function is not available at "Quick" display mode. You can select the display message from 12 stored ones by "Saved number"

Please click the Edit button. Startup Display Edit box is appeared.

Please select the saved number, and display time.

Then click OK button.

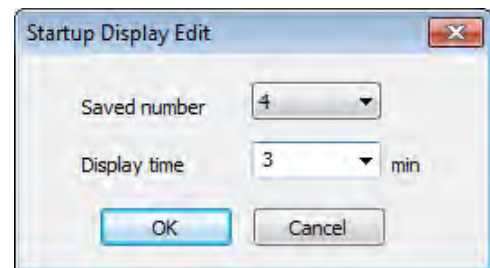
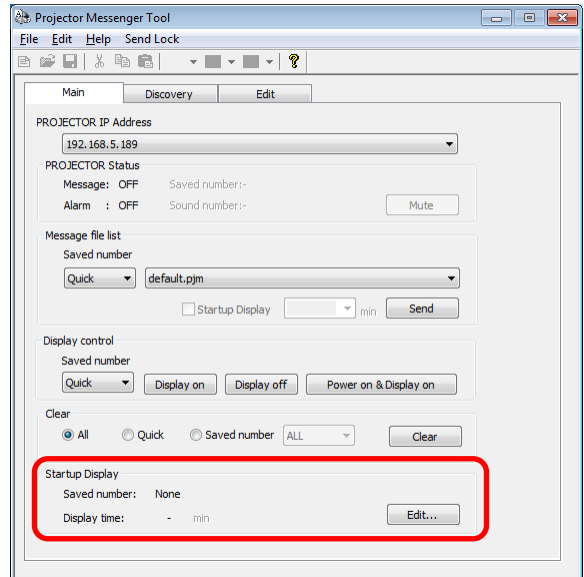

## 6.15 Send Lock

The lock can be put on the Send Button. This function helps to prevent mischief.

1) Lock

Click the [Send Lock].

The pull-down menu appears.

Click the [Send Lock] of the first line.

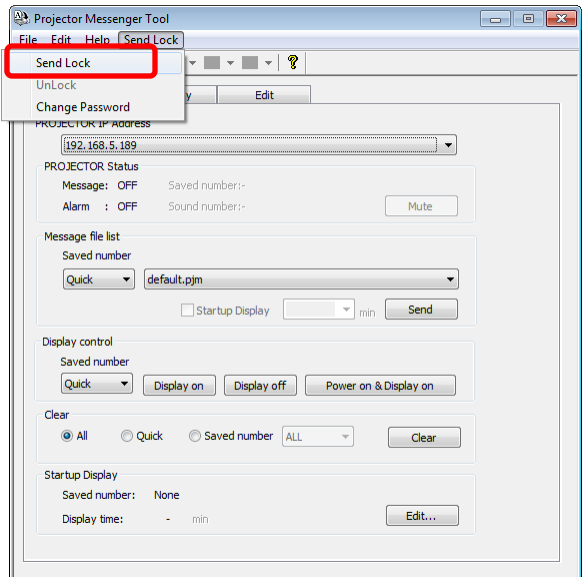
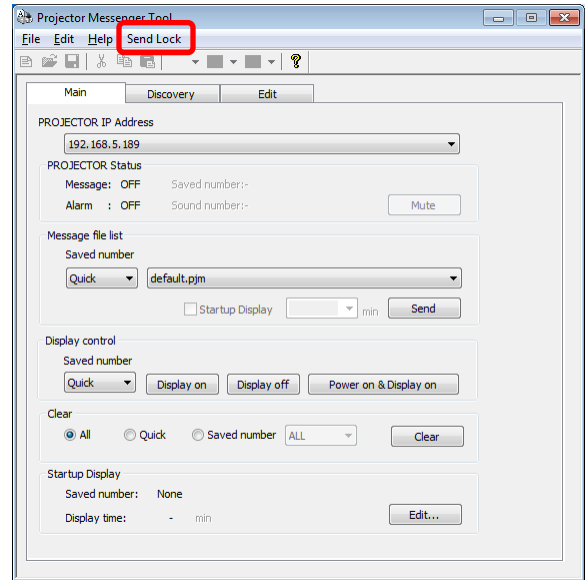



[Send lock] dialog is appeared.

Please enter the password and click [OK].

[Note]

This application software is not set to the password in the state of the installation. Please change the password.

Please refer to "3) Change password".

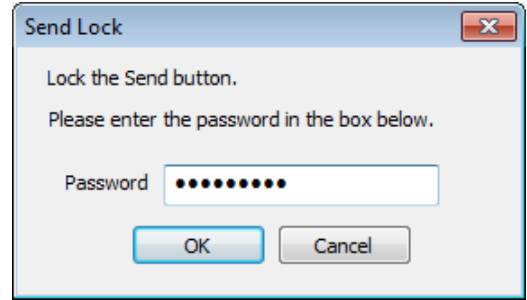

[ Send[Lock] ] is displayed on the [Send] button.

If you click the [ Send[Lock] ] button, the following message is appeared.

You cannot send message data.

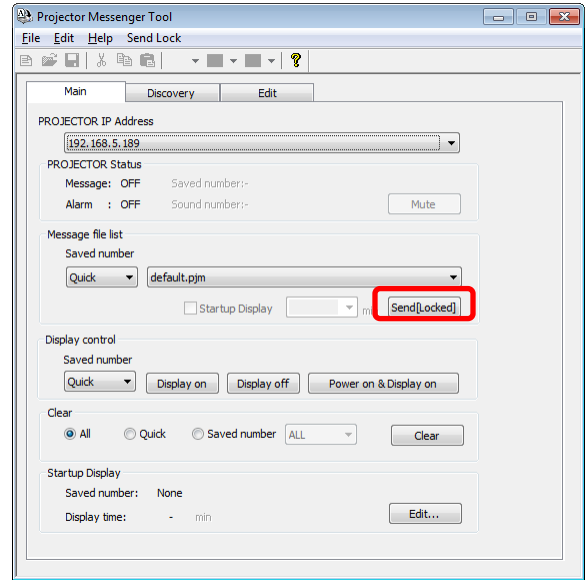
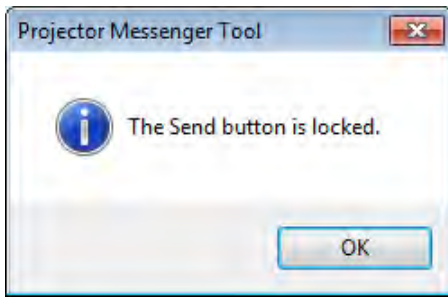

[Note]

The [Send] button of the Main tab and the [Send] button of the Edit tab are synchronized.

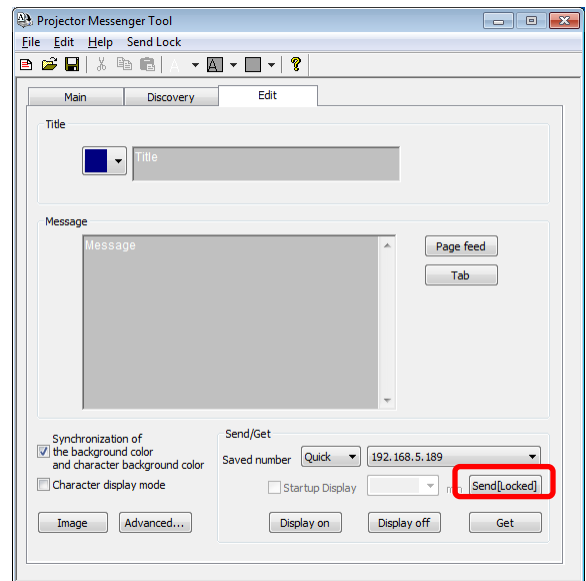

## 2) UnLock

Click the [Send Lock].

The pull-down menu appears.

Click the [UnLock] of the second line.

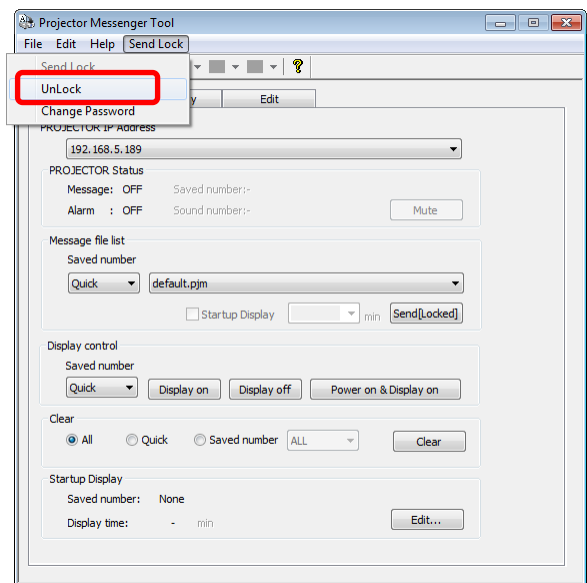
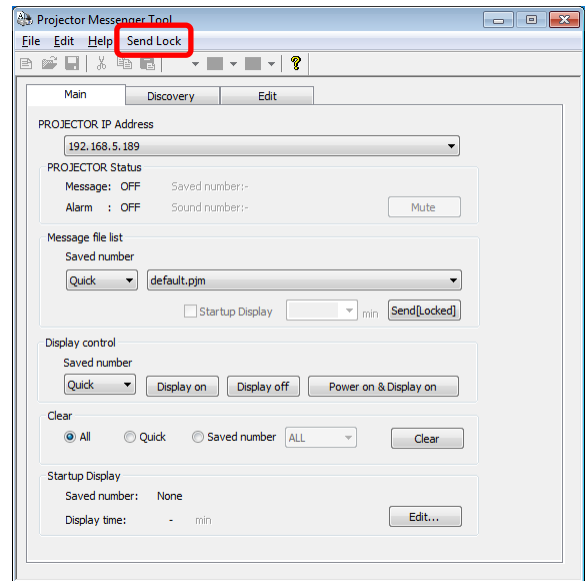

[UnLock] dialog is appeared.

Please enter the password and click [OK].

[Send] button is released.

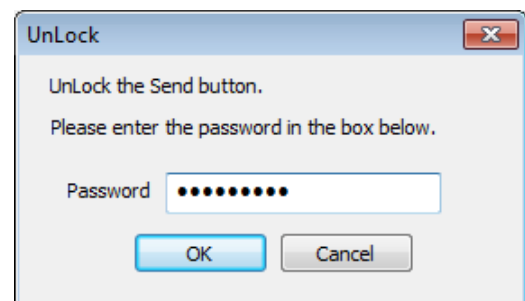

### 3) Change password

Click the [Send Lock].

The pull-down menu appears.

Click the [Change Password] of the third line.

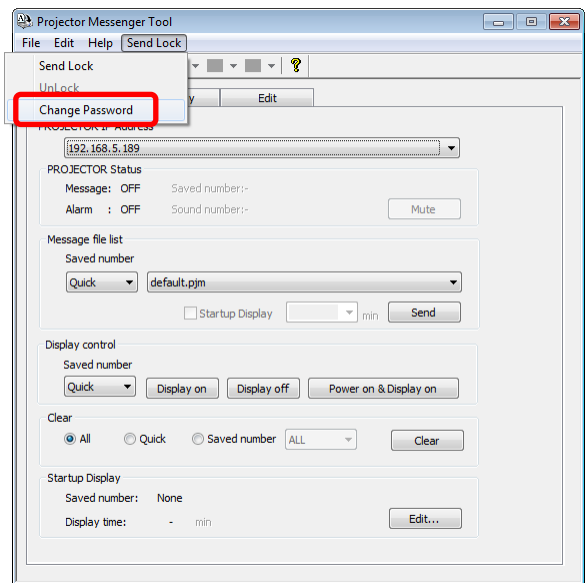
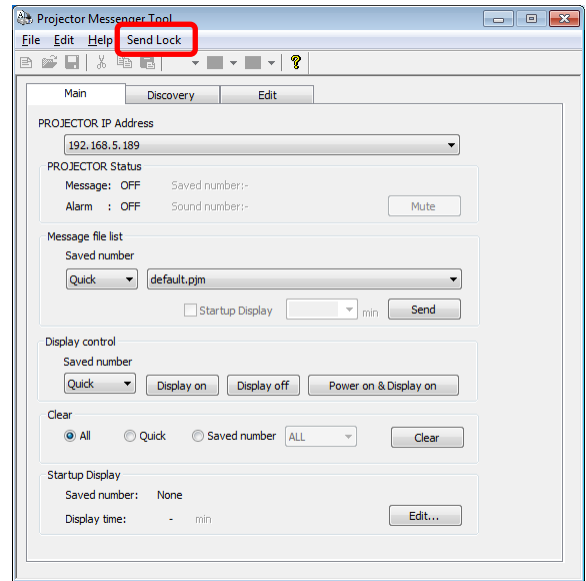

[Change Password] dialog is appeared.

Please enter the current password and the new password, and then click [OK].

[Note]

The password is not set on the initial state.

If you change the password, do not input anything in the [Current Password] and input a new password in the [New Password]. Then click the [OK] button.

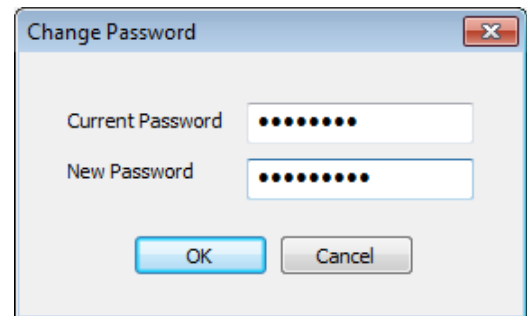

## 6.16 About this Application

To show the software version, please select [Help] → [About], or click .

---

**Corporate offices**

Christie Digital Systems USA, Inc  
Cypress  
ph: 714 236 8610

Christie Digital Systems Canada Inc.  
Kitchener  
ph: 519 744 6005

---

**Worldwide offices**

Australia  
ph: +61 (0) 7 3624 4838

Brazil  
ph: +55 (11) 2548 4753

China (Beijing)  
ph: +86 10 6551 0240

China (Shanghai)  
ph: +86 21 6276 7706

France  
ph: +33 (0) 1 41 21 44 04

Germany  
ph: +49 2161 664540

India  
ph: +91 (080) 6706 9999

Japan (Tokyo)  
ph: 81 3 3599 7461

Korea (Seoul)  
ph: +82 2 702 1601

Mexico  
ph: +52 55 4744 1790

Republic of South Africa  
ph: +27 (0)11 510 0094

Russian Federation  
and Eastern Europe  
ph: +35 (0) 1 47 46 100

Singapore  
ph: +65 6877 8737

Spain  
ph: +34 91 633 9990

United Arab Emirates  
ph: +971 4 3206686

United Kingdom  
ph: +44 (0) 118 977 6000

United States (Arizona)  
ph: 602 943 5700

United States (New York)  
ph: 646 779 2014

---

**Independent sales  
consultant offices**

Italy  
ph: +39 (0) 2 9902 1161



For the most current technical documentation, visit [www.christiedigital.com](http://www.christiedigital.com).

