

INSTRUCTION MANUAL
for
CDN M-series
COUPLING/DECOUPLING
NETWORKS (CDNs)



Table of Contents

1.0	Introduction	5
2.0	Products Available from Com-Power	6
3.0	Product Information	7
3.1	<i>Incoming Inspection.....</i>	7
3.2	<i>Package Inventory.....</i>	7
3.3	<i>Product Safety Information.....</i>	8
3.3.1	<i>Product Hazard Symbols Definitions.....</i>	8
3.3.2	<i>Product Warning/Caution Statements.....</i>	8
3.3.3	<i>General Safety Instructions.....</i>	9
3.4	<i>Product Features.....</i>	11
3.5	<i>Product Specifications.....</i>	12
3.6	<i>Typical Performance Data.....</i>	13
4.0	Product Application.....	14
4.1	<i>CDN Theory.....</i>	14
4.2	<i>Safety Considerations.....</i>	15
4.3	<i>CDN Power Connections.....</i>	16
4.4	<i>CDN Selection.....</i>	18
5.0	Calibration of Electrical Performance Parameters.....	20
5.1	<i>CDN Impedance/Phase.....</i>	21
5.2	<i>CDN Voltage Division Factor.....</i>	22
5.3	<i>CDN Isolation (Decoupling Attenuation).....</i>	23
6.0	Test Level Calibration.....	24
6.1	<i>Calibration Methods.....</i>	24
6.2	<i>Calibration-related Calculations.....</i>	26
6.2.1	<i>Test Level Calculations.....</i>	26
6.2.2	<i>Test Level Offset Calculations.....</i>	29
6.2.3	<i>Test Frequency Calculations.....</i>	30
6.3	<i>Equipment Setup.....</i>	31
6.4	<i>Level Setting Process.....</i>	33
6.5	<i>Amplifier Saturation Check.....</i>	34
7.0	Performing the Test.....	35
7.1	<i>Test Summary and Setup.....</i>	35
7.2	<i>Test Process.....</i>	36
8.0	Warranty.....	37
9.0	Maintenance.....	38

List of Figures

Figure 1 - Product Features	11
Figure 2 - Product Dimensions	12
Figure 3 - Typical Impedance Data	13
Figure 4 - Typical Phase Data	13
Figure 5 - Typical Voltage Division Factor Data	13
Figure 6 - Typical Isolation (Decoupling Attenuation) Data	13
Figure 7 - M-series CDN Schematic as defined in IEC 61000-4-6	14
Figure 8 - Step-by-Step Procedure to Power EUT through CDN	17
Figure 9 - Calibration and Measurement Setup for CDN Impedance/Phase	21
Figure 10 - Normalization and Measurement Setup for CDN Voltage Division Factor	22
Figure 11 - Normalization and Measurement Setup for CDN Isolation (Decoupling Factor)	23
Figure 12 - Examples of Test Generator Equipment	24
Figure 13 - U_{mr} Measurement Line	27
Figure 14 - Calibration of U_{mr} Measurement Line	27
Figure 15 - Connection of CDN Calibration Accessories	31
Figure 16 - Example Equipment Arrangements for Test Level Calibration	32
Figure 17 - Examples of Typical Test Setups	35

List of Tables

Table 1 - Product Specifications	12
Table 2 - EUT/AE Port Connectors	16
Table 3 - CDN Selection According to EUT Current	18
Table 4 - CDN Selection According to Input Power Configuration	18
Table 5 - CDN Impedance Limits	21
Table 6 - CDN Phase Limits	21
Table 7 - Truncated Table of Calibration Frequencies and Step Sizes	30
Table 8 - Examples of Calibration Data/Result Tables	33

List of Equations

<i>Equation 1 - Calculation of CDN Voltage Division Factor</i>	22
<i>Equation 2 - Calculation of CDN Isolation (Decoupling Attenuation)</i>	23
<i>Equation 3 - U_o vs U_{mr} Relationship</i>	26
<i>Equation 4 - Correction of U_{mr} for Attenuator and Insertion Loss of Measurement Cables</i>	28
<i>Equation 5 - Calculation of U_{offset}</i>	29
<i>Equation 6 - Applying U_{offset} to Calibration Data</i>	29
<i>Equation 7 - Calculation of Frequency Step Sizes</i>	30

1.0 Introduction

This manual includes description of product features, typical electrical performance parameters, product specifications, instructions for use, and step by step procedures for calibration of test levels and performing testing. Also included are important safety precautions, warranty and maintenance information.

The test procedures and guidance provided herein is for general guidance and is correct to the extent of our knowledge and understanding of the current, relevant IEC/EN standards at the time that this manual was written. However, the information may become dated or may be inappropriate for some applications.

The user is cautioned to always refer to the appropriate editions of the IEC 61000-4-6, the applicable product family, product environment and/or product specific standard(s) to ensure proper application of the test and adherence to the most appropriate rules, procedures, practices, and/or relevant interpretations thereof for your particular application.

Information contained in this manual is the property of Com-Power Corporation. It is issued with the understanding that the material may not be reproduced or copied without the express written permission of Com-Power.

2.0 Products Available from Com-Power



Antennas



Antenna Kits



Absorbing Clamps



Coupling/Decoupling Networks (CDNs)



Comb Generators



Current Probes & Injection Probes



Emissions Test Systems



Conducted Immunity Test Systems



Impedance Stabilization Networks (ISNs)



Line Impedance Stabilization Networks (LISNs)



Antenna Masts



Near-Field Probe Sets



Preamplifiers



Power Amplifiers



Spectrum Analyzers



Surge Generators



Transient Limiters



Turntables



Antenna Tripods



Telecom Test Systems

www.com-power.com

SECTION 2 - PRODUCTS AVAILABLE FROM COM-POWER

19121 EL TORO ROAD • SILVERADO, CALIFORNIA 92676 • (949) 459-9600 • com-power.com

Rev072518

3.0 Product Information

3.1 Incoming Inspection



WARNING – To avoid possibility of electrical shock, do not apply power to the CDN or any of its accessories if there is any evidence of shipping damage. If shipping damage to the product or any of the accessories is suspected, or if the package contents are not complete, contact Com-Power or your Com-Power distributor.

Please check the contents of the shipment against the package inventory in section 3.2 to ensure that you have received all applicable items.

3.2 Package Inventory

STANDARD ITEMS:

- ✓ **CDN Mxxxx** Coupling/Decoupling Network (CDN)
- ✓ **Calibration Certificate and Data**

OPTIONAL ITEMS:

- ✓ (2) **CDN ADA-Mxxxx** Common-Mode (Shorting) Adapters
- ✓ (2) **ADA-515x** 150Ω to 50Ω Adapters
- ✓ **DCU-300-100W** Directional Coupler
- ✓ **ATTN-6-100W** 6 dB Attenuator
- ✓ **TEP-050** 50Ω Termination

3.3 Product Safety Information

3.3.1 Product Hazard Symbols Definitions

The hazard symbols appearing on the product exterior are defined below.



The yellow triangle with an exclamation mark indicates the presence of important operating and/or maintenance (servicing) instructions in the literature accompanying the product.



The yellow triangle with a lightning bolt indicates an alert to the user that uninsulated **dangerous voltages** are present within the product enclosure and on output connectors. These voltages may be of sufficient magnitude to constitute a risk of electric shock to persons.



The Ground symbol inside a circle indicates terminal which is intended for connection to an external conductor for protection against electric shock in case of a fault, or the terminal of a protective earth (ground) electrode.



To indicate on the rating plate that the equipment is suitable for AC current.



To indicate on the rating plate that the equipment is suitable for direct current.

3.3.2 Product Warning/Caution Statements

The following warnings/caution statements must be adhered to in order to ensure safe operation of the product.



CAUTION:

MAKE ALL CONNECTIONS BEFORE APPLYING POWER.
TO PREVENT ELECTRIC SHOCK, DO NOT OPEN COVER.
NO USER SERVICEABLE PARTS INSIDE.
REFER SERVICING TO QUALIFIED PERSONNEL ONLY.

WARNING:

HIGH LEAKAGE CURRENT, EARTH CONNECTION IS ESSENTIAL BEFORE CONNECTING SUPPLY.

RF PORT
40V Max.

NOTE: The maximum RF voltage level to be applied to the RF Port of the CDN is 40 Volts_{rms}.

3.3.3

General Safety Instructions

The following safety instructions have been included in compliance with safety standard regulations. Please read them carefully.



- **READ AND RETAIN INSTRUCTIONS** - Read all safety and operating instructions before operating the instrument. Retain all instructions for future reference.
- **HEED WARNINGS** - Adhere to all warnings on the instrument and operating instructions.
- **FOLLOW INSTRUCTIONS** - Follow all operating and use instructions.
- **WATER AND MOISTURE** - Do not use the instrument near water.
- **VENTILATION** - The instrument should be used/installed only in locations where the flow of air through the ventilation openings is not impeded.
- **MOUNTING** - The instrument can be used in Horizontal or vertical orientation as long as the ventilation holes are not obstructed and the protective grounding is not defeated.
- **HEAT** - The instrument should be situated away from heat sources such as heat registers or other instruments which produce heat.
- **POWER SOURCES** - Connect the instrument only to the type of power source described in the operating instructions or as marked on the instrument.



- **GROUNDING** - Take precautions to insure that the grounding of the instrument is not defeated. Grounding conductor with adequate cross-section must be connected between a grounding conductor connection for the measurement area and the bottom plate of the CDN. The CDN may also be bonded directly to an existing ground reference plane. At shutdown or before dismantling the CDN setup, ensure that the power to CDN is discontinued before the ground connection is removed.



- **CAUTION** - *The specified minimum line to ground capacitance induces leakage currents in excess of the value permitted under EN 61010-1 standard – safety requirements for electrical equipment for measurement, control and laboratory use.*

In addition, the basic insulation required for a category I protection device cannot be assured. Therefore it is imperative to provide additional measures safeguarding against direct or indirect contact by user.

The operator is responsible for ensuring that protection is maintained during work with the Coupling/Decoupling Network (CDN).

Before using the CDN, a secure ground connection must be made to the LISN grounding bolt and/or the bottom metal plate (The bottom surface of the CDN is left unpainted for effective ground connection). It must not be removed until after the CDN has been disconnected from the mains power supply, in order to avoid electric shock.

The safety notes in the accompanying operating instructions and on the outside of the device must be followed at all times.

SECTION 3 - PRODUCT INFORMATION

- **POWER CORD PROTECTION** - Place power supply cords so that they are not likely to be walked on or pinched by items placed on them or against them.
- **CLEANING** – Clean the instrument outside surfaces of the device with a soft, lint-free cloth. If necessary, a mild detergent may be used.
- **NON-USE PERIODS** - Unplug the power cords of the instrument when it will be left unused for a long period of time.
- **OBJECT AND LIQUID ENTRY** - Take care that objects do not fall into the instruments and that liquids are not spilled into the enclosure through openings.
- **DEFECTS AND ABNORMAL STRESS** - Whenever it is likely that the normal operation has been impaired, make the equipment inoperable and secure it against further operation.
- **SITTING OR CLIMBING** - Do not sit or climb upon the instrument or use it as a step or ladder.
- **ENVIRONMENTAL CONDITIONS** - This equipment is designed for indoor use. Ambient temperature range during operation should be between 5° C to 40° C.
- **STORAGE AND PACKAGING** - The device should only be stored at a temperature between –25 and +70 °C. During extended periods of storage, protect the device from dust accumulation. The original packaging should be used if the device is transported or shipped again. If the original packaging is no longer available, the device should be packed carefully to prevent mechanical damage.

SECTION 3 - *PRODUCT INFORMATION*

3.4 Product Features

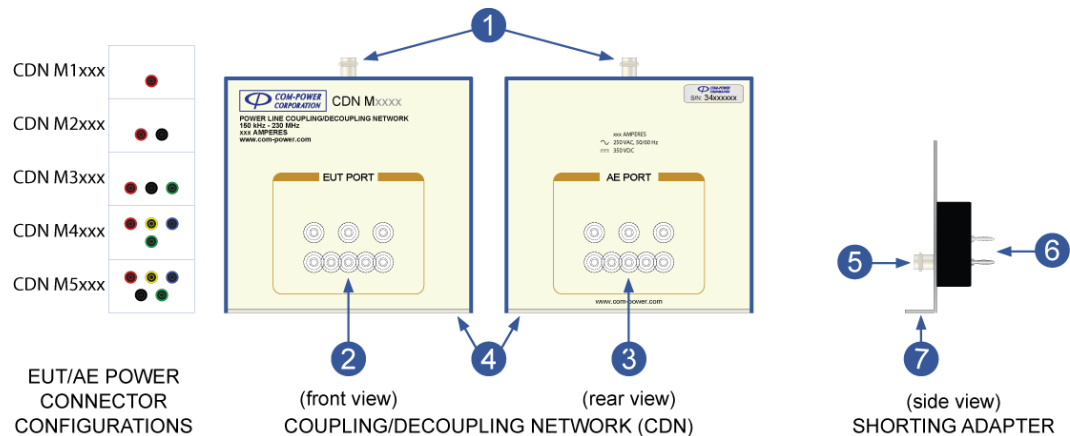

Figure 1 – Product Features

- 1 RF Port**
This is a coaxial BNC (female) connector for connection to the test generator equipment.
- 2 EUT Port**
Port for connection of the EUT power input lines. Depending on the CDN model, this port is fitted with between one (1) and five (5) shrouded power connectors.
- 3 AE Port**
Port for connection to the EUT power source. Depending on the CDN model, this port is fitted with between one (1) and five (5) shrouded power connectors.
- 4 Conductive CDN Base Plate**
This plate provides a means by which the CDN may be bonded directly to a ground plane.
- 5 Shorting Adapter Coaxial Port**
This is a coaxial BNC (female) connector for connection to the shorted [common-mode] connection point of all EUT or AE port conductors.
- 6 Shorting Adapter EUT/AE Port**
Shorting Adapter Port for connection to EUT or AE port conductors. Depending on the CDN model, this port is fitted with between one (1) and five (5) male plug connectors.
- 7 Shorting Adapter Plate**
This conductive plate, when bonded to a ground plane, provides a means by which the shield of the coaxial port is referenced to the ground.

3.5 Product Specifications

Table 1 - Product Specifications

		CDN M125E	CDN M225E	CDN M325E	CDN M425E	CDN M525E	CDNM250E	CDN M350E	CDN M450E	CDN M1100	CDN M2100
GENERAL											
Product Description		Power Line Coupling/Decoupling Networks (CDNs)									
Application		Power Line Conducted Immunity Tests									
Standards		IEC 61000-4-6, CISPR 16-1-2									
Number of Power Line Conductors		1	2	3	4	5	2	3	4	1	2
Common Mode Adapters (2 each)		CDN ADA-M125E	CDN ADA-M225E	CDN ADA-M325E	CDN ADA-M425E	CDN ADA-M525E	CDN ADA-M250E	CDN ADA-M350E	CDN ADA-M450E	CDN ADA-M1100E	CDN ADA-M2100E
Frequency Range		150 kHz to 230 MHz									
Common Mode Impedance	150 kHz to 24 MHz	150Ω (±20Ω)									
	24 MHz to 80 MHz	150Ω (-45Ω / +60Ω)									
	80 MHz to 230 MHz	150Ω (±60Ω)									
Decoupling Attenuation (Isolation) *	150 kHz to 1.5 MHz	15-50 dB	25-55 dB	50 dB	50 dB	50 dB	25-55 dB	40 dB	40 dB	20-45 dB	20-45 dB
	1.5 MHz to 230 MHz	50-20 dB	55-15 dB	50-20 dB	50-10 dB	50-5 dB	55-15 dB	40-20 dB	40-10 dB	45-20 dB	45-20 dB
* slopes increase/decrease linearly with the logarithm of frequency											
Voltage Division Factor		9.5 dB									
Voltage Division Factor	150 kHz to 10 MHz	(-0.5/+1 dB)	(-0.5/+1 dB)	(-0.5/+1 dB)	(-0.5/+1.5 dB)	(-0.5/+1.5 dB)	(-0.5/+1 dB)	(-0.5/+1.5 dB)	(-0.5/+1.5 dB)	(-0.5/+1 dB)	(-0.5/+1 dB)
	10 MHz to 230 MHz	(-0.5/+1.5 dB)	(-0.5/+3 dB)	(-0.5/+2.5 dB)	(-0.5/+2.5 dB)	(-0.5/+3.5 dB)	(-0.5/+4 dB)	(-0.5/+5 dB)	(-0.5/+3.5 dB)	(-0.5/+1 dB)	(-0.5/+2.5 dB)
ELECTRICAL											
Current (maximum continuous, per line)		25 Amperes					50 Amperes			100 Amperes	
Voltage (maximum)		250 Volts AC, 350 Volts DC (line to ground)									
RF Voltage (maximum)		40 Volts _{rms}									
INPUT/OUTPUT CONNECTORS											
EUT/AE Power Ports		4 mm shrouded banana sockets					5.2 mm banana socket with shrouded sheath			Multi-Contact ID/56AR-N-B45	
RF Port		50Ω - BNC-Type (female)									
DIMENSIONS AND WEIGHT											
Figure 2 - Dimension (A)		282 mm					355 mm	370 mm	392 mm	465 mm	
Figure 2 - Dimension (B)		332 mm					413 mm	428 mm	450 mm	525 mm	
Figure 2 - Dimension (C)		155 mm					179 mm				
Figure 2 - Dimension (D)		155 mm					16.8 mm				
Figure 2 - Dimension (E)		166 mm					179 mm				
Figure 2 - Dimension (F)		30 mm					40 mm				
Figure 2 - Dimension (G)		100 mm					100 mm				
Figure 2 - Dimension (H)		100 mm					118 mm				
Figure 2 - Dimension (I)		75 mm					89 mm			82 mm	
Weight (lbs./kg)		4.5 / 2	5.5 / 2.5	5.5 / 2.5	5.5 / 2.5	6 / 2.7	7 / 3.2	7.5 / 3.4	8 / 3.6	12.5 / 5.7	13 / 5.9

All values are typical, unless specified.
All specifications are subject to change without notice.

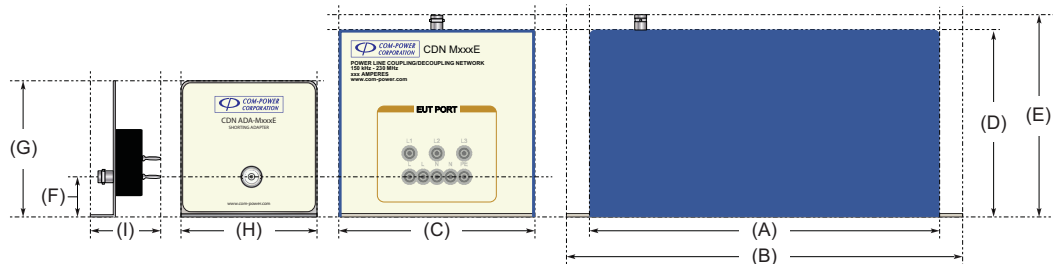

Figure 2 - Product Dimensions

SECTION 3 - PRODUCT INFORMATION

3.6 Typical Performance Data

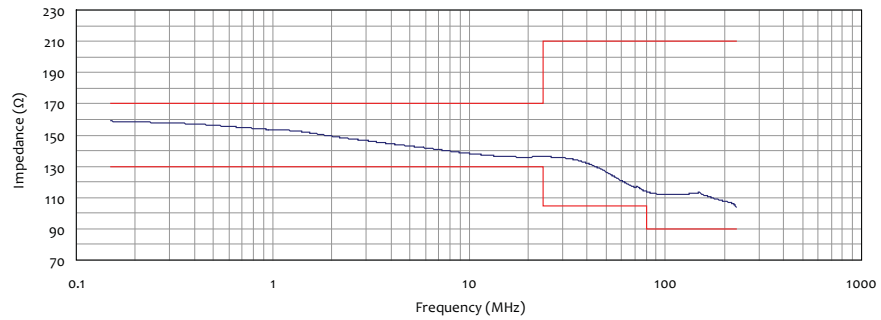

Figure 3 - Typical Impedance Data

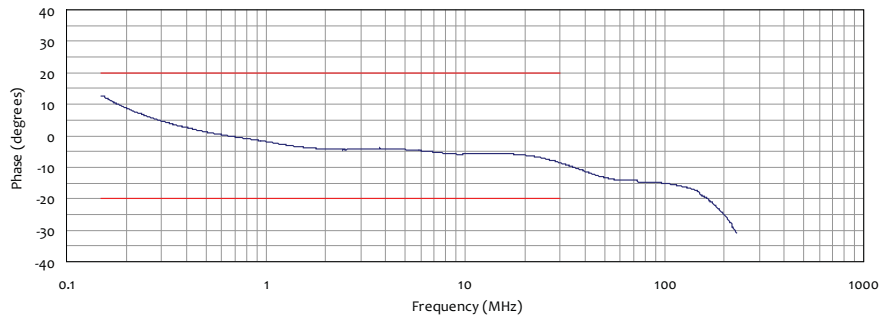

Figure 4 - Typical Phase Data

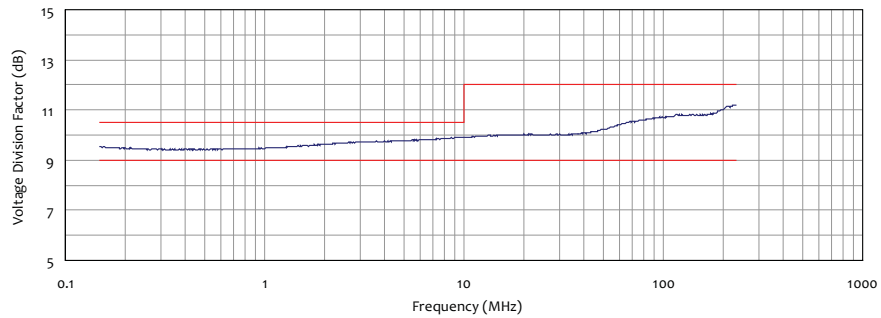

Figure 5 - Typical Voltage Division Factor Data

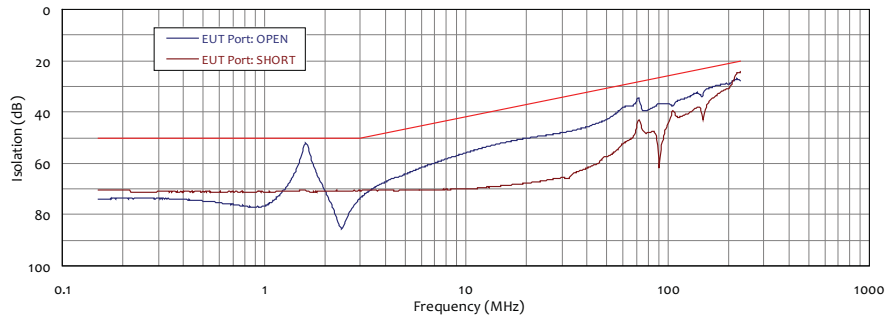

Figure 6 - Typical Isolation (Decoupling Attenuation) Data

SECTION 3 - PRODUCT INFORMATION

4.0 Product Application

4.1 CDN Theory

The CDN M-series Coupling/Decoupling Networks (CDNs) are specifically designed for immunity to conducted disturbances testing as per IEC 61000-4-6.

CDNs provide a standardized common mode impedance for the EUT power lines which is independent of the external power line impedance. The RF test signal is injected via the RF port of the CDN, and is coupled onto the EUT power lines (directly for the PE conductor, and capacitively for all other conductors) through an effective resistance of 100 ohms. Refer to Figure 7 below.

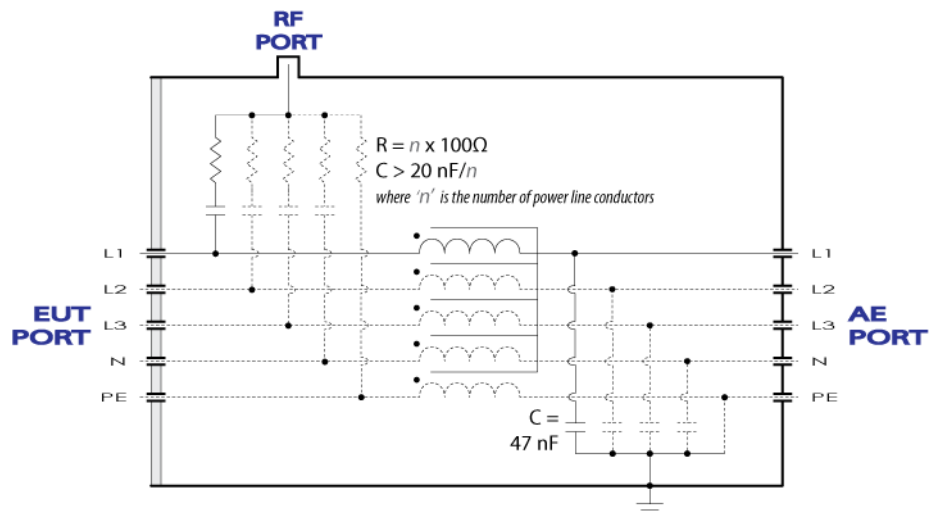

Figure 7 - M-series CDN Schematic as defined in IEC 61000-4-6

Once coupled onto the power conductors within the CDN, the RF path to the EUT is unimpeded, while the RF path to the AE port is impeded by common-mode chokes and decoupling capacitors, thereby protecting the AE equipment.

4.2 Safety Considerations

It is critical that the CDN be installed in a manner which ensures that EACH of following conditions are satisfied:



- The metal enclosure of the CDN must be connected to the reference ground plane. The recommended connection method is via a direct, surface to surface connection between the CDN base plate and an exposed, conductive surface of the floor or wall of a shielded enclosure. The CDN base plate should be bolted to the surface using the mounting holes on the front and back of the CDN base plate.
- No signal or operating voltages/currents shall exceed those specified in the product specifications listed in section 3.5.
- The CDN power input port must be connected to an appropriate power source protected by a circuit breaker with a current rating which is greater than or equal to the rating of the CDN.



Due to the high level of earth leakage current, the device cannot be connected to any power source protected by a Ground Fault Circuit Interrupter (GFCI), also called Ground Fault Interrupter (GFI) or Residual Current Device (RCD).

Failure to comply with any of these points may damage the equipment and/or pose an electrical hazard.

4.3 CDN Power Connections

All Com-Power M-series CDNs are equipped with shrouded safety connectors for both the EUT Port and AE Port. All connections to these ports must be made with mating shrouded safety connectors. The mating connectors for the 50 Amp CDNs are provided. The mating connectors for the 25 Amp and 100 Amp CDNs can be purchased commercially and are commonly available. The mating connectors for all M-series CDNs are listed below in Table 2.

Table 2 - EUT/AE Port Connectors

CDN Model	EUT/AE Port Connectors	Mating Connectors
CDN M125E	4 mm Shrouded Banana Sockets	4 mm Shrouded Banana Plugs 
CDN M225E		
CDN M325E		
CDN M425E		
CDN M525E		
CDN M250E	MFG: Mittal Electronics Type: 200 50 Amps Sheathed Sockets Panel Mounting	MFG: Mittal Electronics Type: 201 50 Amps Sheathed Spring Loaded Banana Plugs (PROVIDED WITH CDN) 
CDN M350E		
CDN M450E		
CDN M1100	MFG: Staubli (formerly: Multi-Contact) Type: ID/S6AR-N-B4S 6 mm Safety Flush-Mounting Plugs	MFG: Staubli (formerly: Multi-Contact) Type: KBT6AR-N/16-S 6 mm Safety Sockets 
CDN M2100		

To power the EUT through an M-series CDN, follow the step-by-step procedure described in Figure 8.

Step #1 - Attach CDN to ground plane.



Step #2 - Attach the appropriate mating connectors to each conductor of CDN power input cable and EUT power cable.



Step #3 - Plug each conductor of CDN power input cable and EUT power cable into the appropriate CDN sockets.



Step #4 - Connect CDN power input cable to EUT power source.

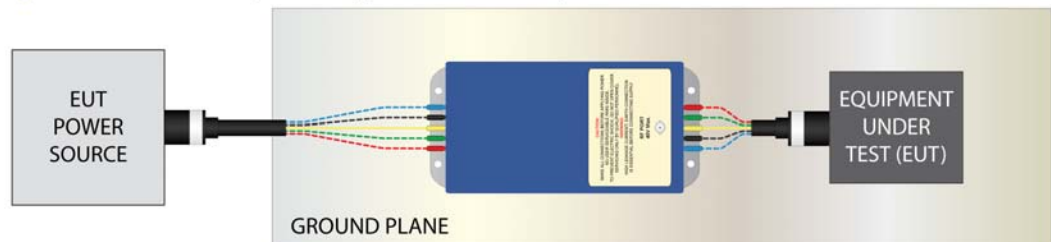

Figure 8 – Step-by-Step Procedure to Power EUT through CDN

4.4 CDN Selection

NOTE: The user is reminded that the applicable standard(s) for your application take precedence over the information contained in this manual. The following information is provided only for guidance; please refer to section 1 for full disclaimer.

The M-series CDNs are used only on power lines. The appropriate M-series CDN is selected based on:

- 1) the DC or AC rms current requirements for the Equipment Under Test (EUT) based on Table 3 below; and,

Table 3 - CDN Selection According to EUT Current

EUT Current	Applicable CDN(s)
≤25 Amperes	CDN Mx25E CDN Mx50E CDN Mx100
≤50 Amperes	CDN Mx50E CDN Mx100
≤100 Amperes	CDN Mx100

- 2) the input power configuration of the device to be powered through the CDN, based on Table 4 below; and,

Table 4 - CDN Selection According to Input Power Configuration

EUT Power Configuration	Applicable CDN(s)
Separately-routed power input conductor or functional earth port (ground stud)	CDN M1xxx
2 CONDUCTORS DC (+/-) or 1Ø AC (line + neutral) [ROUTED TOGETHER]	CDN M2xxx
3 CONDUCTORS DC (+/-)*, 1Ø AC (line + neutral)*, or splitØ AC (line + line)* *WITH 3rd-wire GND [ROUTED TOGETHER]	CDN M3xxx
4 CONDUCTORS 3Ø AC (Delta) (L1 + L2 + L3 + GND) [ROUTED TOGETHER]	CDN M4xxx
5 CONDUCTORS 3Ø AC (Wye) (L1 + L2 + L3 + Neutral + GND) [ROUTED TOGETHER]	CDN M5xxx

SECTION 4 - PRODUCT INSTALLATION

- 3) the routing of the supply wires in the device's actual installation, as supply wires that will be individually routed require separate CDN-M1 CDNs for each wire to be installed for the test; and,
- 4) whether the EUT is provided with functional earth terminals (e.g. for RF purposes or high leakage currents), which shall be connected to the reference ground plane:
 - through the CDN-M1 when the characteristics or specification of the EUT permit. In this case, the (power) supply shall be provided through an appropriate CDN-Mx type network;
 - when the characteristics or specification of the EUT do not permit the presence of a CDN-M1 network in series with the earth terminal for RF or other reasons, the earth terminal shall be directly connected to the reference ground plane. In this case the CDN-M3 network shall be replaced by a CDN-M2 network to prevent an RF short-circuit by the protective earth conductor. When the equipment was already supplied via CDN-M1 or CDN-M2 networks, these shall remain in operation;
 - for a 3-phase supply, a similar adjustment needs to be done regarding the use of an appropriate CDN M-series network.

5.0 Calibration of Electrical Performance Parameters

Calibration of Coupling/Decoupling Networks can be divided into two categories.

The first category includes the calibration/measurement of its electrical performance parameters, such as common mode impedance, phase, voltage division factor and, in some cases, isolation (or decoupling attenuation).

These calibrations are typically performed on a periodic basis in order to verify that the CDN continues to be in proper working order, (i.e.: functioning within its prescribed specifications and/or in compliance with the applicable requirements. These calibrations are discussed in the following sections.

The second category includes test level calibrations, which will be discussed in detail in section 6.

5.1 CDN Impedance/Phase

The impedance/phase is typically measured using an Impedance Analyzer or Network Analyzer with S-parameter Test Set. A typical test setup for analyzer calibration and measurement of impedance/phase is illustrated in Figure 9. Calibration of analyzers is typically performed using the OPEN/SHORT/LOAD (OSL) method, using female BNC standards. The impedance/phase measurement is performed once with the AE port conductors shorted to GND, and again with the AE port conductors shorted together, but not shorted to GND.

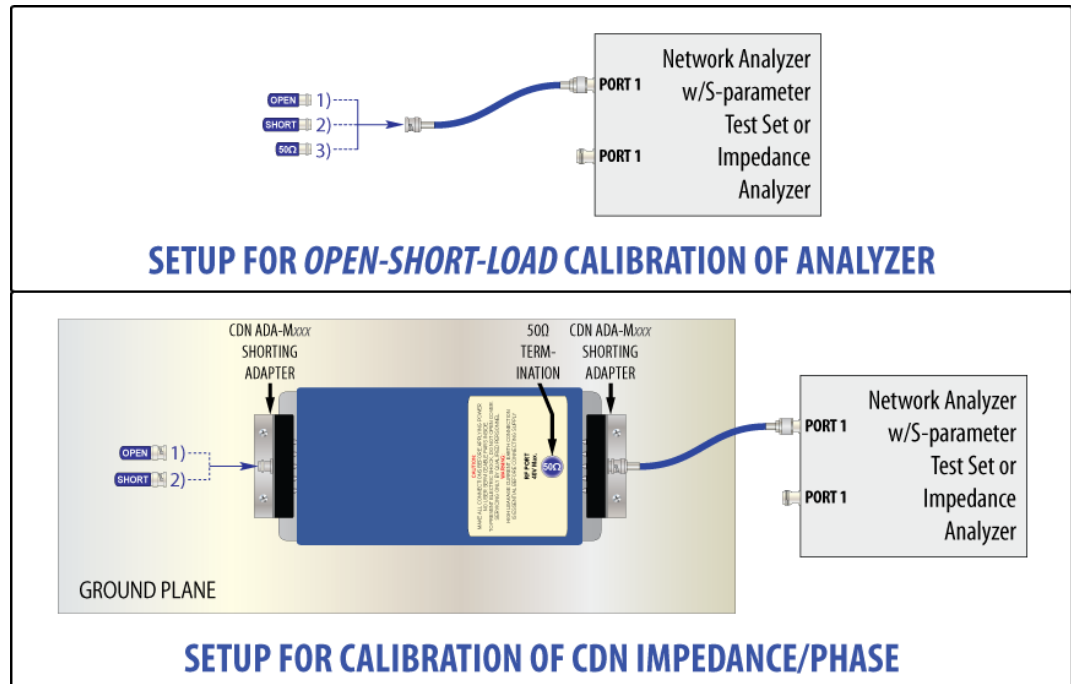

Figure 9 - Calibration and Measurement Setup for CDN Impedance/Phase

The limits for impedance are given in Table 3 and Table B.1 (informative) of IEC 61000-4-6, and are shown here in Table 5.

Table 5 - CDN Impedance Limits

Frequency Range	Impedance Limits
0.15 to 24 MHz	150Ω ±20Ω
24 to 80 MHz	150Ω +60Ω/-45Ω
80 to 230 MHz	150Ω ±60Ω

The phase limits are given in section 6.2.2 of CISPR 16-1-2, and are shown here in Table 6.

Table 6 - CDN Phase Limits

Frequency Range	Impedance Limits
0.15 to 30 MHz	0° ±20°

5.2 CDN Voltage Division Factor

The voltage division factor of a CDN is the difference between the voltage level injected into RF port of the CDN, and the voltage measured at the output of the 150Ω to 50Ω adapter connected to the EUT port of the CDN. See Equation 1.

Equation 1 - Calculation of CDN Voltage Division Factor

$$V_{div} \text{ (in dB)} = 20 * \log \left(\frac{V_{in} \text{ (in Vrms)}}{V_{out} \text{ (in Vrms)}} \right) \quad \text{-or-} \quad V_{div} \text{ (in dB)} = V_{in} \text{ (in dB)} - V_{out} \text{ (in dB)}$$

where...

- V_{div} = voltage division factor
- V_{in} = voltage into RF port of CDN
- V_{out} = voltage measured (across 50Ω input impedance of measuring instrument) at the output of the [150Ω to 50Ω adapter connected to the EUT port of CDN] = U_{mr}

A typical setup for equipment normalization and measurement of the voltage division factor is illustrated in Figure 5.

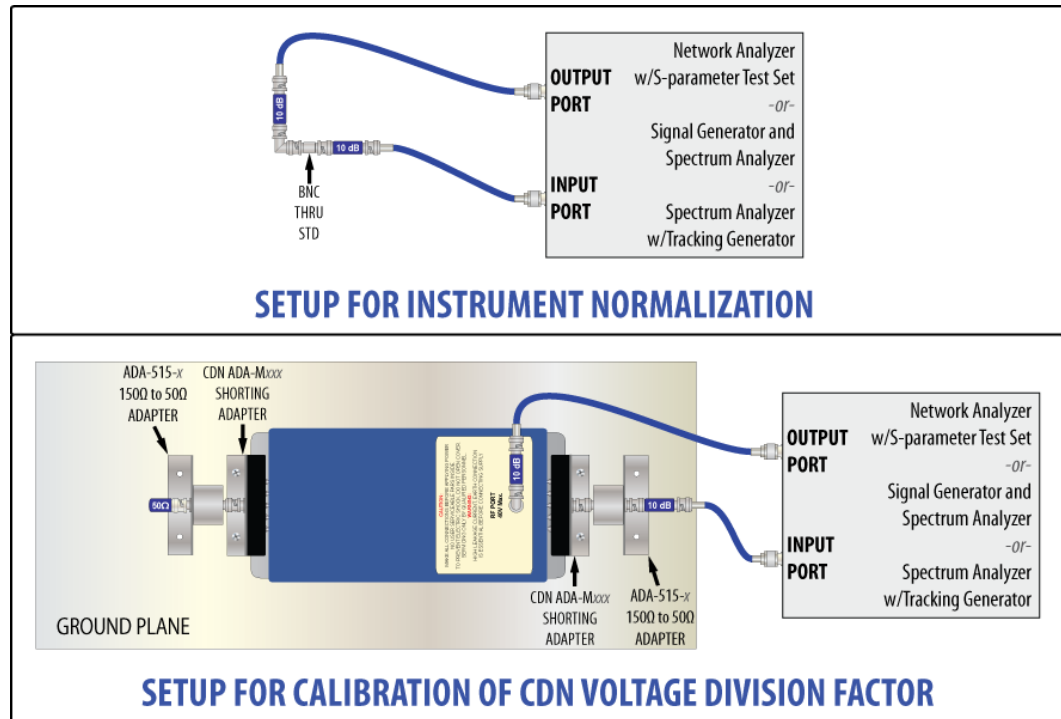

Figure 10 –Normalization and Measurement Setup for CDN Voltage Division Factor

5.3 CDN Isolation (Decoupling Attenuation)

Isolation, or decoupling attenuation, is the attenuation provided by the CDN between its AE and EUT ports. However, the isolation is measured by injecting a voltage (V_{in}) into the AE port through a 150Ω to 50Ω Adapter, measuring the voltage level at the RF port (V_{out}) with the EUT port open and then shorted to GND (see Figure 11). The isolation is calculated as shown in Equation 2.

Equation 2 - Calculation of CDN Isolation (Decoupling Attenuation)

$$V_{iso} \text{ (in dB)} = 20 * \log \left(\frac{V_{in(AE)} \text{ (in Vrms)}}{V_{out(RF)} \text{ (in Vrms)}} \right) - V_{div} \text{ (in dB)} \quad \text{-or-} \quad V_{iso} \text{ (in dB)} = V_{in(AE)} \text{ (in dB)} - V_{out(RF)} \text{ (in dB)} - V_{div} \text{ (in dB)}$$

where...

- V_{iso} = CDN isolation (decoupling factor)
- V_{div} = Voltage Division Factor
- $V_{in(AE)}$ = voltage into the 150Ω to 50Ω adapter connected to the AE port of the CDN
- $V_{out(RF)}$ = voltage measured (across 50Ω input impedance of measuring instrument) at RF port of CDN

A typical setup for equipment normalization and measurement of the CDN isolation (decoupling factor) is illustrated in Figure 11.

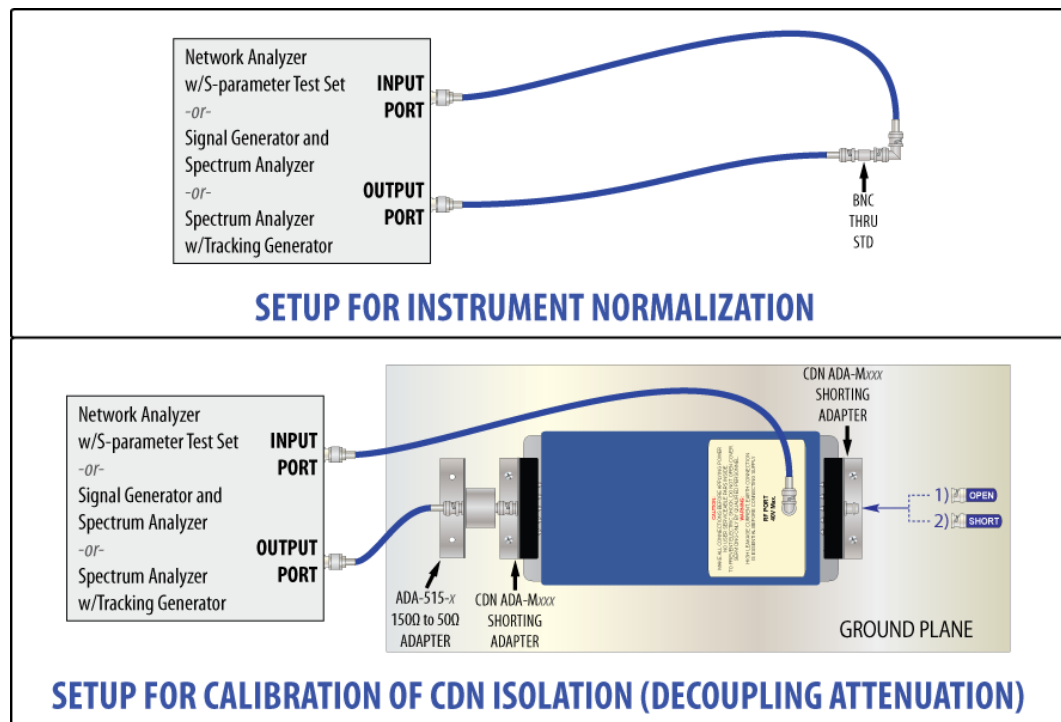

Figure 11 - Normalization and Measurement Setup for CDN Isolation (Decoupling Factor)

6.0 Test Level Calibration

The following sections describe the calculations, measurement setups, as well as a step-by-step procedure for performing test level calibration per the IEC 61000-4-6 standard.

Test level calibration is typically performed prior to the start of a test, for the purpose of setting the specific level for the test to be performed (i.e.: 1 Vrms, 3 Vrms, 10 Vrms, etc.).

This calibration, as well as the actual test, is performed at a minimum of 633 discrete frequencies. While it is possible to perform these processes manually (without software), it is highly recommended that it be performed as an automated process, under software control.

6.1 Calibration Methods

Per the IEC 61000-4-6 standard, there are two acceptable methods for monitoring/recording the test generator output level when the appropriate test level is obtained at any given frequency during the calibration, so that the same respective level can be reproduced during the actual testing process. For the purposes of this procedure, we will refer to these methods as **METHOD A (Signal Generator Output Method)** and **METHOD B (Forward Power Method)**. Shown in Figure 12 are examples of the Test Generator Equipment used for the two respective methods.

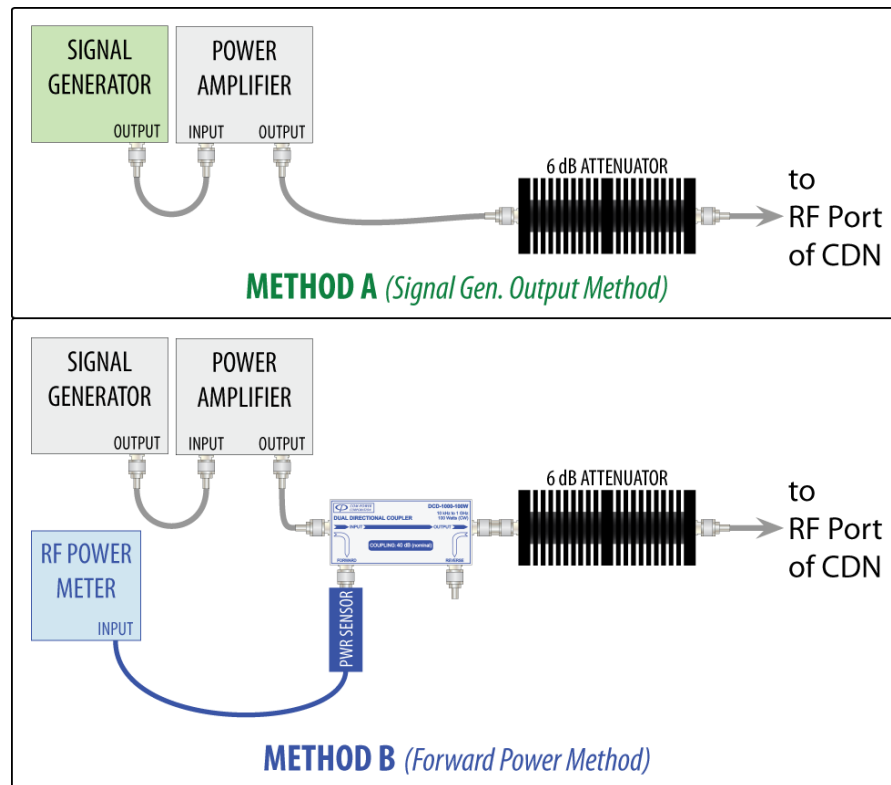

Figure 12 - Examples of Test Generator Equipment

SECTION 6 - TEST LEVEL CALIBRATION

In the following procedures, instructions are included for both methods. **Instructions common for both METHOD A and METHOD B are shown in BLACK text. Any instructions applicable only for METHOD A are shown in GREEN text. Any instructions applicable only for METHOD B are shown in BLUE text.**

For each method, as will be discussed later in this chapter, the test generator equipment is used to inject the test signal into RF port of the CDN. The test level is set by measuring the amplitude of the test signal at the output of the 150Ω to 50Ω Adapter connected to the EUT port of the CDN (through a power attenuator). For each test frequency, the amplitude of the injected RF is adjusted incrementally until the measured amplitude reaches the appropriate level (**U_{mr}**).

The primary difference between the two methods relates to:

- a) the method with which the test generator output is quantified at each frequency during calibration when the appropriate test level is achieved; and,
- b) the method with which the same test generator output level set during calibration is reproduced at each frequency during actual EUT testing.

METHOD A: For method A, once the appropriate amplitude is measured at any given frequency during calibration process, the signal generator output level is recorded, along with the frequency.

Then, during the test, the signal generator output level at any given frequency will be set to the respective level that was recorded during the calibration process.

METHOD B: For method B, once the appropriate amplitude is measured at any given test frequency during the calibration process, the forward power of the test generator and frequency is recorded. The forward power can be measured with an RF power meter and power sensor, or it can be measured with a spectrum analyzer/EMI receiver. The measuring instrument is typically connected to the forward port of a directional coupler installed in series with the drive line, between the RF output of the power amplifier and the input port of the CDN.

During the test, the signal generator output level is adjusted so that the forward power measured on the power meter or spectrum analyzer/EMI receiver at any given test frequency is equal to the respective forward power level recorded during the calibration process.

SECTION 6 - TEST LEVEL CALIBRATION

6.2 Calibration-related Calculations

6.2.1 Test Level Calculations

Prior to the start of the calibration process, U_{mr} must be calculated. U_{mr} represents the voltage to be measured at the output of the 150Ω to 50Ω Adapter connected to the EUT port of the CDN, and must not be confused with the **open circuit test level (U_o)** for the calibration (i.e.: 1 Vrms, 3 Vrms, 10 Vrms, etc., as specified in Table 1 of IEC 61000-4-6). The relationship between U_{mr} and U_o for CDN calibration is given in Equation 3:

Equation 3 – U_o vs U_{mr} Relationship

in linear terms...

$$\frac{U_o}{6} = U_{mr}$$

(in Vrms) (in Vrms)

in logarithmic terms...

$$U_o - 15.6 \text{ dB} = U_{mr}$$

(in dBμV) (in dBμV)

where...

U_o = open circuit rms voltage

U_{mr} = voltage measured (across 50Ω input impedance of measuring instrument) at the output of the [150Ω to 50Ω adapter connected to the EUT port of the CDN]

NOTE: The 6:1 ratio, or factor of 6 (15.6 dB) is due to the following:

- a) the open circuit voltage is double the matched load voltage, yielding a **2:1** voltage ratio; and,
- b) the EUT port of the CDN is terminated by 150 ohms (150Ω to 50Ω Adapter (100 ohms) in series with the 50 ohm input impedance of the measuring instrument). So, the measurement is made across one-third of the total load impedance, yielding a **3:1** voltage ratio.

So, for instance, for calibration performed at an **open circuit test level (U_o)** of **10 Vrms**:

in linear terms...

$$\frac{10 \text{ Vrms } [U_o]}{6} = 1.67 \text{ Vrms } [U_{mr}]$$

in logarithmic terms...

$$140 \text{ dBμV } [U_o] - 15.6 \text{ dB} = 124.4 \text{ dBμV } [U_{mr}]$$

Additionally, shown in Figure 13 are the coaxial cables and attenuator installed between the output of the 150Ω to 50Ω Adapter (where U_{mr} is measured) and the measuring instrument.

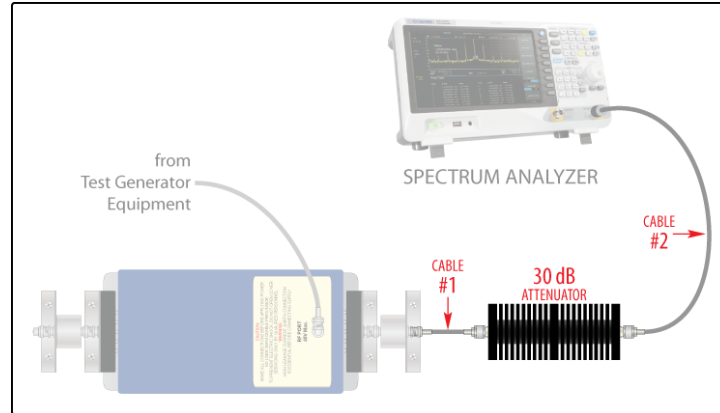

Figure 13 - U_{mr} Measurement Line

The calculated U_{mr} value must be corrected for the attenuation of the attenuator and the insertion losses of Cable #1 and Cable #2 shown in Figure 13. These losses are frequency dependent, and should be quantified over the entire frequency range of the calibration, preferably as a system. Illustrated in Figure 14 is the setup for instrument normalization and the system-level insertion loss measurement.

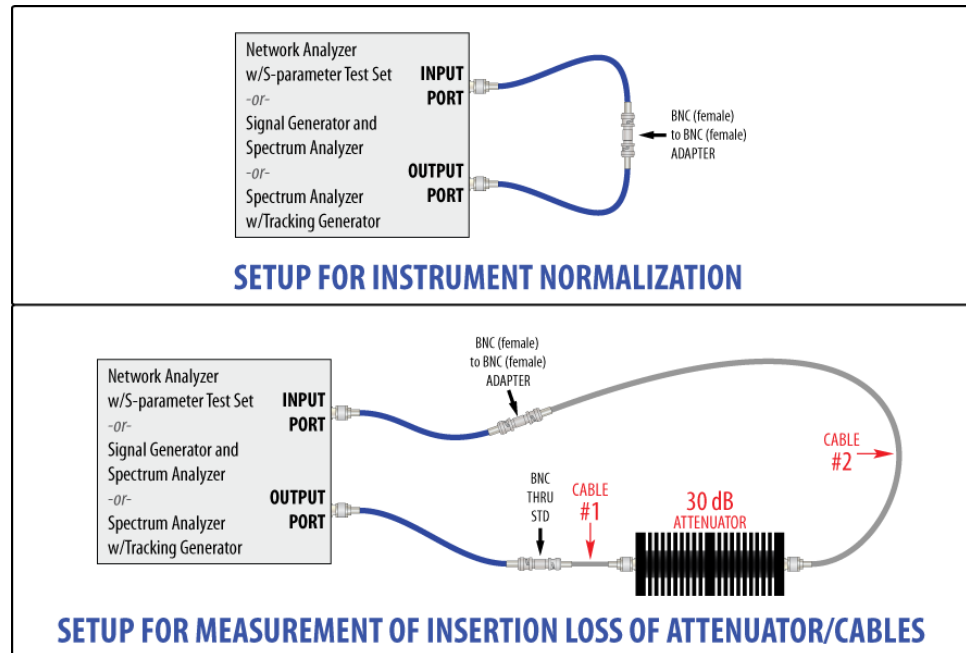

Figure 14 - Calibration of U_{mr} Measurement Line

SECTION 6 - TEST LEVEL CALIBRATION

Using the U_{mr} Measurement Line calibration results, the U_{mr} value calculated using Equation 3 can now be corrected using Equation 4. As the calibration results are frequency-dependent, the corrections must be applied with respect to frequency.

Equation 4 - Correction of U_{mr} for Attenuator and Insertion Loss of Measurement Cables

$$\underset{\text{(in dB}\mu\text{V)}}{U_{mr}} - \underset{\text{(in dB)}}{U_{mr} \text{ Loss}@f_x} = \underset{\text{(in dB}\mu\text{V)}}{U_{mr-ATT(xx)}@f_x}$$

where...

$U_{mr-ATT(xx)}$ = voltage measured (across 50Ω input impedance of measuring instrument) at the output of the U_{mr} measurement line, which consists of the attenuator and cable(s) connected between the [output of the 150Ω to 50Ω adapter connected to the EUT port of the CDN] and the measuring instrument; with "xx" representing the rated attenuation value (in dB)

U_{mr} = voltage measured (across 50Ω input impedance of measuring instrument) at the [output of the 150Ω to 50Ω adapter connected to the EUT port of the CDN]

$U_{mr} \text{ Loss}$ = combined, measured loss of the attenuator and cable(s) connected between the [output of the 150Ω to 50Ω adapter connected to the EUT port of the CDN] and the input of the measuring instrument

@ f_x = at any given frequency

Again, for calibration to be performed at an **open circuit test level** of **10 Vrms**, and assuming a measured 31 dB loss for the U_{mr} Measurement Line, which included the 30 dB attenuator and both cables:

$$\underset{[U_{mr}]}{124.4 \text{ dB}\mu\text{V}} - \underset{[U_{mr} \text{ Loss}]@f_x}{31 \text{ dB}} = \underset{[U_{mr-ATT(30)}]@f_x}{94.4 \text{ dB}\mu\text{V}}$$

So, when the measured value at the output of the attenuator connected to the 150Ω to 50Ω Adapter connected to the EUT port of the CDN is equal to the calculated $U_{mr-ATT(xx)}$ value for any given frequency, the test level has been achieved.

6.2.2 Test Level Offset Calculations

If the CDN will be used for multiple test levels (1 Vrms, 3 Vrms, 10 Vrms, etc.), calibration should be performed at the highest test level. Calibration data for the lower test levels can then be calculated as shown in Equation 5.

Equation 5 - Calculation of U_{offset}

$$U_{offset (in\ dB)} = 20 \cdot \log \left(\frac{U_{cal (in\ Vrms)}}{U_{calc (in\ Vrms)}} \right) \quad \text{or} \quad U_{offset (in\ dB)} = U_{cal (in\ dB)} - U_{calc (in\ dB)}$$

where...

$$U_{cal} = \text{calibrated test level}$$

$$U_{calc} = \text{calculated test level}$$

For instance, if the calibration was performed for a test level of 10 Vrms, and the offset is needed for a test level of 3 Vrms:

$$20 \cdot \log \left(\frac{10\ Vrms [U_{cal}]}{3\ Vrms [U_{calc}]} \right) = \frac{10.46\ dB}{[U_{offset}]} \quad \text{or} \quad \frac{140\ dB\mu V}{[U_{cal}]} - \frac{129.54\ dB\mu V}{[U_{calc}]} = \frac{10.46\ dB}{[U_{offset}]}$$

The offset factor calculated above can then be applied to the calibration results at the higher test level using Equation 6.

Equation 6 - Applying U_{offset} to Calibration Data

$$SGout_{calc (in\ dB)} = SGout_{cal (in\ dB)} - U_{offset (in\ dB)}$$

$$FWDpwr_{calc (in\ dB)} = FWDpwr_{cal (in\ dB)} - U_{offset (in\ dB)}$$

where...

$$SGout_{calc} = \text{calculated signal generator output for lower test level}$$

$$SGout_{cal} = \text{calibrated signal generator output for higher test level}$$

$$FWDpwr_{calc} = \text{calculated forward power for lower test level}$$

$$FWDpwr_{cal} = \text{calibrated forward power for higher test level}$$

6.2.3 Test Frequency Calculations

The frequency range of the test is, in most cases, 150 kHz to 80 MHz; and, in some cases, 150 kHz to 230 MHz. The calibration and test is performed at discrete, logarithmically spaced frequencies (as opposed to a frequency sweep). The logarithmic spacing of the test frequencies means that the actual step size increases after each step. The maximum step size at any given frequency is equal to 1% of the present frequency, as calculated using Equation 7.

Equation 7 - Calculation of Frequency Step Sizes

$$f_{step} = (f * 0.01)$$

$$f_{next} = f + f_{step} \quad \text{-or-} \quad f_{next} = f + (f * 0.01)$$

where...

f_{next} = next calibration frequency

f = current calibration frequency

f_{step} = frequency step size from current to next frequency

A truncated example of the test frequencies, showing the respective step sizes is shown in Table 7.

Table 7 - Truncated Table of Calibration Frequencies and Step Sizes

TEST FREQUENCY		STEP SIZE
(MHz)	(kHz)	
1	0.15	1.5
2	0.1515	1.515
3	0.153015	1.53
4	0.154545	1.545
5	0.15609	1.561
6	0.157651	1.577
7	0.159228	1.592
8	0.16082	1.608
9	0.162428	1.624
10	0.164052	1.641

TEST FREQUENCY		STEP SIZE
(MHz)	(kHz)	
11	0.165693	1.657
12	0.16735	1.674
13	0.169024	1.69
14	0.170714	1.707
15	0.172421	1.724
16	0.174145	1.741
17	0.175886	1.759
18	0.177645	1.776
19	0.179421	1.794
20	0.181215	1.812

TEST FREQUENCY		STEP SIZE
(MHz)	(kHz)	
21	0.183027	1.83
22	0.184857	1.849
23	0.186706	1.867
631	79.16929	791.69
632	79.96098	799.61
633	80.76059	807.606

TEST FREQUENCY		STEP SIZE
(MHz)	(kHz)	
634	81.568196	815.682
635	82.383878	823.839
636	83.207717	832.077
737	227.312	2273.12
738	229.58512	414.88
739	230	

SECTION 6 - TEST LEVEL CALIBRATION

6.3 Equipment Setup

On a conductive ground plane, connect the M-series CDN and Calibration Accessories/Adapters as shown in Figure 15. The bottom surfaces of the CDN, both shorting adapters, and both 150Ω to 50Ω Adapters should be flush against the top surface of the ground plane, and should be either:

- a) fastened using bolts or screws directly to the ground plane (through their respective mounting holes); or,
- b) bonded to the ground plane using copper tape with conducted adhesive (3M #1181 HD recommended).

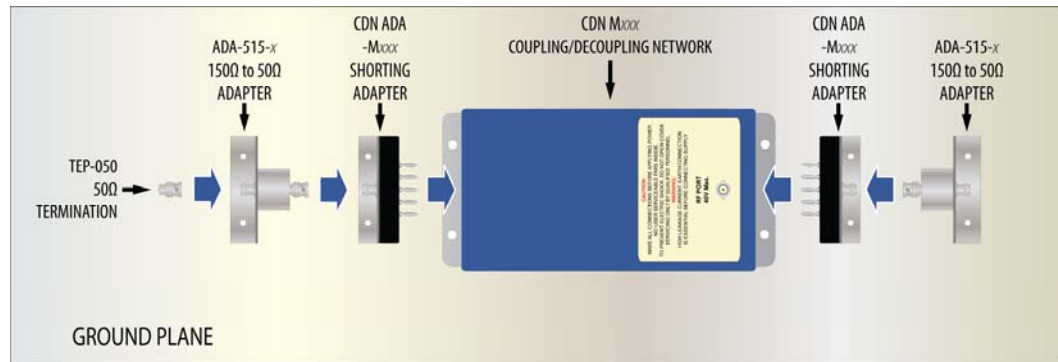

Figure 15 - Connection of CDN Calibration Accessories

The CDN ADA-Mxxx Shorting Adapters, or Common Mode Adapters short circuit all of the power conductors to the center pin of its BNC connector.

The ADA-515-x 150Ω to 50Ω Adapter is a non-inductive 100 ohm resistor as defined in the IEC 61000-4-6 standard.

The TEP-050 50Ω Termination is a 2.5W, 50 ohm termination.

As shown in Figure 16, complete the calibration setup for **METHOD A** or **METHOD B**, as appropriate.

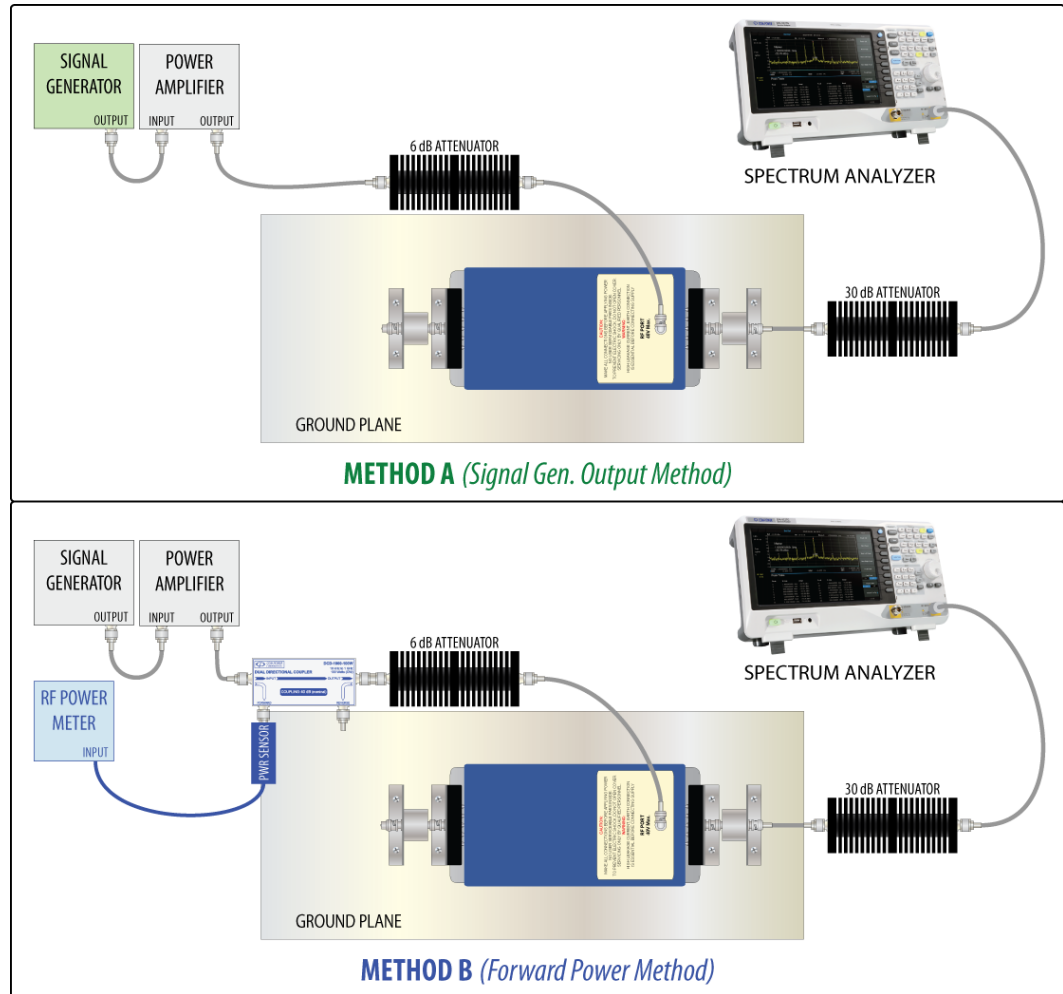

Figure 16 - Example Equipment Arrangements for Test Level Calibration

SECTION 6 - TEST LEVEL CALIBRATION

6.4 Level Setting Process

Step #1 With the calibration test setup configured as shown in Figure 16, set the frequency of the signal generator and measuring instrument to 150 kHz (without modulation).

Step #2 WITHOUT exceeding [the 1 dB gain compression point of the power amplifier minus 5.1 dB], adjust the amplitude setting of the signal generator until the amplitude measured on the measuring instrument is equal to the $U_{mr-ATT(xx)}$ value (± 1.5 dB) calculated as described in section 6.2.1 for the open circuit test level (U_o) for which calibration is being performed.

Step #3 **Record either:**
the frequency (f_x) and amplitude setting of the signal generator (SG_{out})

-or-

the frequency (f_x) and measured forward power (FWD_{pwr})

See examples of calibration data/results tables below.

Table 8 - Examples of Calibration Data/Result Tables

#	TEST FREQ (f_x) (MHz)	SIGNAL GEN OUTPUT SG_{out} (dBxx)
1	0.15	xx.xx
2	0.1515	xx.xx
3	0.153015	xx.xx
↓	↓	↓
633 or 739	80 or 230	xx.xx

#	TEST FREQ (f_x) (MHz)	FORWARD POWER FWD_{pwr} (dBxx)
1	0.15	xx.xx
2	0.1515	xx.xx
3	0.153015	xx.xx
↓	↓	↓
633 or 739	80 or 230	xx.xx

Step #4 Increase the frequency of the signal generator and measuring instrument by a maximum of 1% of the present frequency, as described in section 6.2.3.

Step #5 Repeat steps 2 through 4 until the next frequency in the sequence would exceed the highest frequency of the calibration/test. For tests up to 80 MHz, there should be at least 633 test frequencies; and for tests up to 230 MHz, there should be at least 739 test frequencies.

SECTION 6 - TEST LEVEL CALIBRATION

6.5 **Amplifier Saturation Check**

Step #1 Set the frequency of the signal generator to 150 kHz (without modulation).

Step #2 Adjust the signal generator output to *either*:
the respective **SGout** value determined during calibration for the present test frequency.

-or-

the level at which the power indicated by the power meter is equal to the respective **FWDpwr** value determined during calibration for the present test frequency.

Step #3 Record the amplitude measured on the measuring instrument as **U_{mr}**.

Step #4 Increase the signal generator output by 5.1 dB, and record the amplitude measured on the measuring instrument as **U_{mr(inc)}**. The difference between **U_{mr}** and **U_{mr(inc)}** must be between 3.1 dB and 7.1 dB.

Step #5 Increase the frequency of the signal generator to the next test frequency.

Step #6 Repeat steps 2 through 5 until the next frequency in the sequence would exceed the highest frequency of the test.

7.0 Performing the Test

7.1 Test Summary and Setup

Examples of typical test setups for **METHOD A** and **METHOD B** are shown in Figure 17 for an EUT having a single power input port (and no other I/O ports) with one to five power conductors, and no other input/output ports.

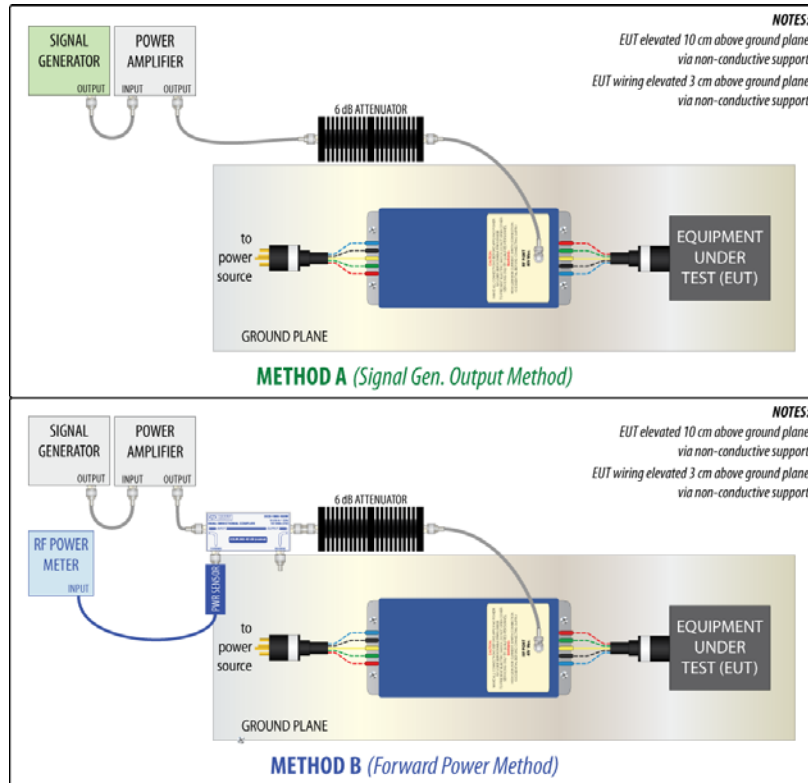

Figure 17 - Examples of Typical Test Setups

Test setups for devices having multiple I/O ports are more complex, and usually require multiple CDNs of different types. Refer to the IEC 61000-4-6 standard for guidance.

When a CDN is employed as a CDN in the test setup, but is not connected to the Test Generator equipment, a 50 ohm terminator must be connected to its RF port. A CDN can also be employed in the test setup as a Decoupling Networks (DN), as described in IEC 61000-4-6, by leaving its RF port open (no connection).

The test is typically performed starting from the lowest test frequency up to the highest test frequency, one test frequency at a time, with a one to three second dwell time at each test frequency, depending on the reaction time of the EUT. The RF carrier is usually 80% amplitude modulated with a 1 kHz sine wave.

Refer to the applicable IEC 61000-4-6 and/or relevant product family or product environment standard(s) to ensure the proper application of the test.

SECTION 7 - PERFORMING TESTING

7.2 Test Process

The same Test Generator equipment used for the calibration is used to inject the RF energy onto the EUT lines under test via the CDN during the test.

Step #1 With the test setup configured as shown in Figure 17, and/or as required by the applicable standard(s), and with the EUT being exercised as required for the test, set the frequency of the signal generator to 150 kHz, modulated as required (usually 1 kHz AM @ 80%).

Step #2 Using the appropriate calibration data/result table for the test level at which the test will be performed, set the signal generator output to *either*:

- a) *the respective **SGout** value determined during calibration for the present test frequency; or,*
- b) *the level at which the power indicated by the power meter is equal to the respective **FWDpwr** value determined during calibration for the present test frequency.*

Step #3 Dwell at the present frequency no less than the time necessary for the EUT to be exercised and to respond, but in no case less than 500 ms.

Step #4 Decrease the amplitude by a few dB, then set the frequency of the signal generator to the next test frequency.

Step #5 Repeat steps 2 through 5 until the next frequency in the sequence would exceed the highest frequency of the test.

8.0 Warranty

Com-Power warrants to its Customers that the products it manufactures will be free from defects in materials and workmanship for a period of three (3) years. This warranty shall not apply to:

- Transport damages during shipment from your plant.
- Damages due to poor packaging.
- Products operated outside their specifications.
- Products Improperly maintained or modified.
- Consumable items such as fuses, power cords, cables, etc.
- Normal wear
- Calibration
- Products shipped outside the United States without the prior knowledge of Com-Power.

In addition, Com-Power shall not be obliged to provide service under this warranty to repair damage resulting from attempts to install, repair, service or modify the instrument by personnel other than Com-Power service representatives.

Under no circumstances does Com-Power recognize or assume liability for any loss, damage or expense arising, either directly or indirectly, from the use or handling of this product, or any inability to use this product separately or in combination with any other equipment.

When requesting warranty services, it is recommended that the original packaging material be used for shipping. Damage due to improper packaging will void warranty.

In the case of repair or complaint, Please visit our website www.com-power.com and fill out the service request form (<http://com-power.com/repairservicereq.asp>). Our technical assistance personnel will contact you with an RMA number. The RMA number should be displayed in a prominent location on the packaging and on the product, along with a description of the problem, and your contact information.

SECTION 8 - WARRANTY

9.0 Maintenance

This product contains no user serviceable parts. If the unit does not operate or needs calibration, please contact Com-Power Corporation. Any modifications or repairs performed on the unit by someone other than an authorized factory trained technician will void warranty.

The exterior surface may be cleaned with mild detergent and then be wiped with a dry, clean, lint-free cloth. Use care to avoid liquids or other foreign objects entering the chassis.