

**INSTRUCTION MANUAL**  
For  
**LINE IMPEDANCE STABILIZATION NETWORK**

**Model LIN-120C**  
**150 kHz to 30 MHz**



## Table of Contents

|     |  |    |
|-----|--|----|
| 1.0 | Introduction .....                       | 3  |
| 2.0 | Products Available from Com-Power.....   | 4  |
| 3.0 | Product Safety Information .....         | 5  |
| 3.1 | Product Hazard Symbols Definitions ..... | 5  |
| 3.2 | Incoming Inspection .....                | 6  |
| 3.3 | Package Inventory .....                  | 6  |
| 3.4 | General Safety Instructions.....         | 6  |
| 4.0 | Product Specifications .....             | 9  |
| 5.0 | Product Description.....                 | 10 |
| 5.1 | Overview.....                            | 10 |
| 5.2 | Product Setup .....                      | 10 |
| 5.3 | Front & Rear Panel Marking .....         | 11 |
| 6.0 | LISN Theory .....                        | 13 |
| 7.0 | Typical Performance Data.....            | 14 |
| 8.0 | Warranty .....                           | 16 |
| 8.1 | Maintenance .....                        | 16 |

## List of Figures

|  |    |
|--|----|
| Figure 1: Single Phase connection with one set of LISN                         | 10 |
| Figure 2: Three Phase connections with two sets of LISN                        | 11 |
| Figure 3: Rear Panel   | 11 |
| Figure 4: Front Panel  | 11 |
| Figure 5: Example of equivalent LISN circuit                                   | 13 |
| Figure 6: Typical Impedance compared to ANSI C63.4 & CISPR 16-1-2 requirements | 14 |
| Figure 7: Typical Phase compared to CISPR 16-1-2 requirements.                 | 14 |
| Figure 8: Typical Isolation compared to CISPR 16-1-2 requirements              | 15 |
| Figure 9: Typical Insertion Loss   | 15 |

## 1.0 INTRODUCTION

This manual includes descriptions of front and rear panel ports, controls and indicators; product specifications, safety precautions, operational instructions and warranty information and guidelines and instructions for its proper usage.

Information contained in this manual is the property of Com-Power Corporation. It is issued with the understanding that the material may not be reproduced or copied without the express written permission of Com-Power.

## 2.0 PRODUCTS AVAILABLE FROM COM-POWER



*Antennas*



*Antenna Kits*



*Absorbing Clamps*



*Coupling/Decoupling Networks (CDN)*



*Comb Generators*



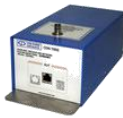
*Current Probes*



*Emissions Test Systems*



*Conducted Immunity Test Systems*



*Impedance Stabilization Networks (ISN)*



*Line Impedance Stabilization Networks (LISN)*



*Antenna Masts*



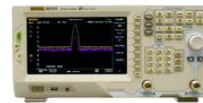
*Near-Field Probe Sets*



*Preamplifiers*



*Power Amplifiers*



*Spectrum Analyzers*



*Product Safety Test Equipment*



*Transient Limiters*



*Turntables*



*Antenna Tripods*



*Telecom Test Systems*

[www.com-power.com](http://www.com-power.com)

## 3.0 PRODUCT SAFETY INFORMATION

### 3.1 Product Hazard Symbols Definitions

The hazard symbols appearing on the product exterior are defined below.



The yellow triangle with an exclamation mark indicates the presence of important operating and/or maintenance (servicing) instructions in the literature accompanying the product.



The yellow triangle with a lightning bolt indicates an alert to the user that un-insulated dangerous voltages are present within the product enclosure and on output connectors. These voltages may be of sufficient magnitude to constitute a risk of electric shock to persons.



The Ground symbol inside a circle indicates terminal which is intended for connection to an external conductor for protection against electric shock in case of a fault, or the terminal of a protective earth (ground) electrode.



To indicate on the rating plate that the equipment is suitable for AC current.



To indicate on the rating plate that the equipment is suitable for direct current.

## 3.2 Incoming Inspection



To avoid possibility of electrical shock, do not apply power to the LISN if there is any evidence of shipping damage. If shipping damage to the product or any of the accessories is suspected, or if the package contents are not complete, contact Com-Power or your Com-Power distributor.

Please check the contents of the shipment against the package inventory in section 3.3 to ensure that you have received all applicable items.

## 3.3 Package Inventory

Equipment, accessories, and documents supplied with the model LIN-120C LISN are as follows:

- Calibration data and Certificate traceable to NIST.
- AC Power cord (NEMA 6-20P Plug with the IEC-60320-C19 Connector).

### Optional items

- ISO-17025 calibration data and certificate.
- External transient limiter model LIT-153.

## 3.4 General Safety Instructions

The following safety instructions have been included in compliance with safety standard regulations. Please read them carefully.

- **READ AND RETAIN INSTRUCTIONS** - Read all safety and operating instructions before operating the instrument. Retain all instructions for future reference.
- **HEED WARNINGS** - Adhere to all warnings on the instrument and operating instructions.
- **FOLLOW INSTRUCTIONS** - Follow all operating and use instructions.
- **WATER AND MOISTURE** - Do not use the instrument near water.
- **VENTILATION** - The instrument should be used/installed only in locations where the flow of air through the ventilation openings is not impeded.
- **MOUNTING** - The instrument can be used in Horizontal or vertical orientation as long as the ventilation holes are not obstructed and the protective grounding is not defeated.
- **HEAT** - The instrument should be situated away from heat sources such as heat registers or other instruments which produce heat.
- **POWER SOURCES** - Connect the instrument only to the type of power source described in the operating instructions or as marked on the instrument.





• **GROUNDING** - Take precautions to insure that the grounding of the instrument is not defeated. Grounding conductor with adequate cross-section must be connected between a grounding conductor connection for the measurement area and the grounding conductor connection (grounding bolt) on the back panel of the LISN and the LISN bottom plate, before applying any power to the LISN. At shutdown or before dismantling the LISN setup, ensure that the power to LISN is discontinued before the ground conductor connection is disconnected.



**CAUTION:**

*The LIN-120C is based on the 50  $\mu$ H artificial mains network (AMN) circuit and component values (Figure 3) specified in ANSI C 63.4 – 2009 American National Standard for Methods of Measurement of Radio-Noise Emissions from Low-Voltage Electrical and Electronic Equipment in the Range of 9 kHz to 40 GHz*

*The specified minimum line to ground capacitance induces leakage currents in excess of the value permitted under EN 61010-1 standard – safety requirements for electrical equipment for measurement, control and laboratory use.*

*In addition, the basic insulation required for a category I protection device cannot be assured. Therefore it is imperative to provide additional measures safeguarding against direct or indirect contact by user.*

*The operator is responsible for ensuring that protection is maintained during work with the line impedance stabilization network (LISN).*

*Before using the LISN, a secure ground connection must be made to the LISN's grounding bolt and/or the bottom metal plate (The bottom surface of the LISN is left unpainted for effective ground connection). It must not be removed until after the LISN has been disconnected from the mains power supply, in order to avoid electric shock.*

*The safety notes in the accompanying operating instructions and on the outside of the device must be followed at all times.*

- **POWER CORD PROTECTION** - Place power supply cords so that they are not likely to be walked on or pinched by items placed on them or against them.
- **CLEANING** – Clean the instrument outside surfaces of the device with a soft, lint-free cloth. If necessary, a mild detergent may be used.
- **NON-USE PERIODS** - Unplug the power cords of the instrument when it will be left unused for a long period of time.
- **OBJECT AND LIQUID ENTRY** - Take care that objects do not fall into the instruments and that liquids are not spilled into the enclosure through openings.
- **DEFECTS AND ABNORMAL STRESS** - Whenever it is likely that the normal operation has been impaired, make the equipment inoperable and secure it against further operation.

- **SITTING OR CLIMBING** - Do not sit or climb upon the instrument or use it as a step or ladder.
  
- **ENVIRONMENTAL CONDITIONS** - This equipment is designed for indoor use. Ambient temperature range during operation should be between 5° C to 40° C.
  
- **STORAGE AND PACKAGING** - The device should only be stored at a temperature between -25 and +70 °C. During extended periods of storage, protect the device from dust accumulation. The original packaging should be used if the device is transported or shipped again. If the original packaging is no longer available, the device should be packed carefully to prevent mechanical damage.



## 4.0 PRODUCT SPECIFICATIONS

|   |  |
|---|--|
| <b>Model:</b>                               | <b>LIN-120C</b>  |
| <b>Electrical</b>                           |  |
| <b>Frequency range:</b>                     | 150 kHz to 30 MHz                                      |
| <b>Compliant standards:</b>                 | CISPR 16-1-2 Edition 2.0: 2014-03, ANSI<br>C63.4: 2014 |
| <b>Number of lines:</b>                     | Two lines  |
| <b>Max current rating:</b>                  | 20 Amp AC, 14 Amp DC                                   |
| <b>Max Voltage rating:</b>                  | 270 VAC, 50/60 Hz (Line to Ground)/<br>380 VDC         |
| <b>Inductor type:</b>                       | 50 $\mu$ H   |
| <b>EUT connector:</b>                       | IEC 60320, C-20 receptacle                             |
| <b>Power input connector:</b>               | Universal multi-configuration                          |
| <b>RF measurement connector:</b>            | 50 $\Omega$ , N type (female)                          |
| <b>Mechanical</b>                           |  |
| <b>Dimensions of Each LISN (H x W x D):</b> | 6.6 x 14.3 x 13 inches / 16.8 x 36.5 x 33 cm           |
| <b>Weight of each LISN :</b>                | 10.5 lbs / 4.7 kg                                      |
| <b>Environmental</b>                        |  |
| <b>Operating Temperature</b>                | 5° C to 40° C / 40° F to 104° F                        |

## 5.0 PRODUCT DESCRIPTION

### 5.1 Overview

The LIN-120C Line Impedance Stabilization Network is specifically designed to provide necessary measurement platform for performing power line conducted emissions (disturbance measurements) compliance testing as required for FCC, CISPR, CE and other worldwide standards for commercial products. It is fully compliant with the requirements of both CISPR 16-1-2 and ANSI C63.4.

The LIN-120C performs each of the following functions during the measurement:

- provides a defined, stable impedance throughout the measurement frequency range;
- isolates the EUT and measurement circuit from the power source, thereby minimizing its influence on the measurements; and,
- couples the disturbance voltages to the coaxial measurement port for connection to the measuring instrument like EMI Receiver or Spectrum Analyzer.

### 5.2 Product Setup

Before initiating use of LISN, ensure that,

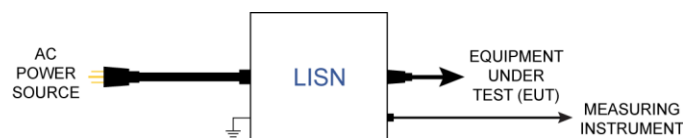


- PE conductor is connected to ground.
- The ventilation openings are unobstructed.
- No signal or operating voltages above the permissible limits given in specification.
- The LISN's power input port is connected to an appropriate power source employing properly rated mains protection, as over current protection is not provided in the LISN.

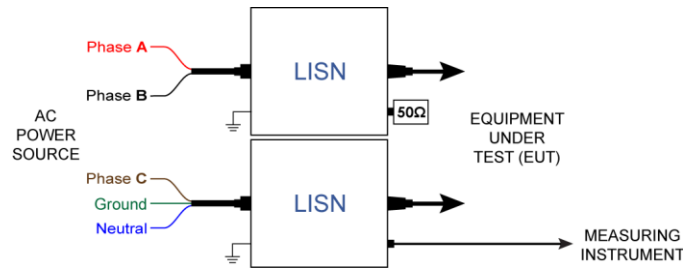
Failure to comply with any of these points may damage the equipment and/or pose an electrical hazard.

#### 5.2.1 Typical connection diagrams

The LISNs can be used with single phase power sources with one set of LISN and also three phase power sources (requires two sets of LISNs). Given below are the typical connection setup's for each configuration.

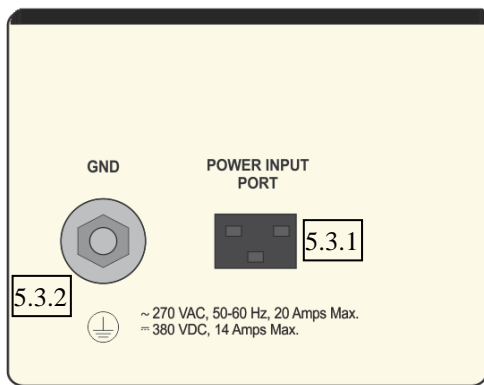


**Figure 1: Single Phase connection with one set of LISN**



**Figure 2: Three Phase connections with two sets of LISN**

### 5.3 Front & Rear Panel Marking



**Figure 4: Rear Panel**



**Figure 3: Front Panel**

#### 5.3.1 Power input port

The Model LIN-120C has a IEC C20 receptacle for connection to an external DC or AC input power source.



#### CAUTION

*Due to the high level of earth leakage current, the device cannot be connected to any power source protected by either a ground fault circuit interrupter (GFCI) circuit breaker or residual current devices (RCDs). The power source must be protected by a circuit breaker with a current rating which is greater than or equal to the rating of the LISN.*



#### 5.3.2 Grounding bolt (GND)

The threaded bolt with hex nut marked 'GND' are found on rear panel of the LISN. This bolt is used for Protective grounding connections. In addition to this, the un-painted bottom surface of the LISN should be bonded directly to an earth referenced ground plane for effective RF reference ground. In cases where no ground plane is available, a mains isolating transformer shall be used.

Please refer Safety instructions for more information on importance of grounding. The grounding instructions are to be followed at all times.

### **5.3.3 EUT power port**

The LIN-120C has a universal multi-configuration receptacle to power the equipment under test.

### **5.3.4 EMI measurement Port**

The LIN-120C provides a 50  $\Omega$  N-Type (female) connector to connecting the Spectrum analyzer or EMI receiver for making conducted noise measurements. The shielding connection of the N connector shield is connected to the housing of the LISN and thus to ground.

### **5.3.5 Test lead selection switch (Line / LI or Neutral / L2)**

This switch allows selection of leads to facilitate measurement of noise/emissions from each line. The line that is not being measured is automatically terminated internally by a 50  $\Omega$  terminator. However, the power to EUT is uninterrupted.

### **5.3.6 Transient Limiter switch**

User can turn the built in transient limiter on and off using this switch. CISPR recommends the use of 10 dB attenuator at the output of the LISN measurement port. Also, as the input circuitry of EMI receivers and spectrum analyzers are extremely sensitive; it is highly recommended to keep the transient limiter ON in order to protect the input circuits from damage by high voltage transients. The built in transient limiters also incorporate both a low pass and high pass filter to attenuate out of band signals, as well as a 10 dB attenuation pad.

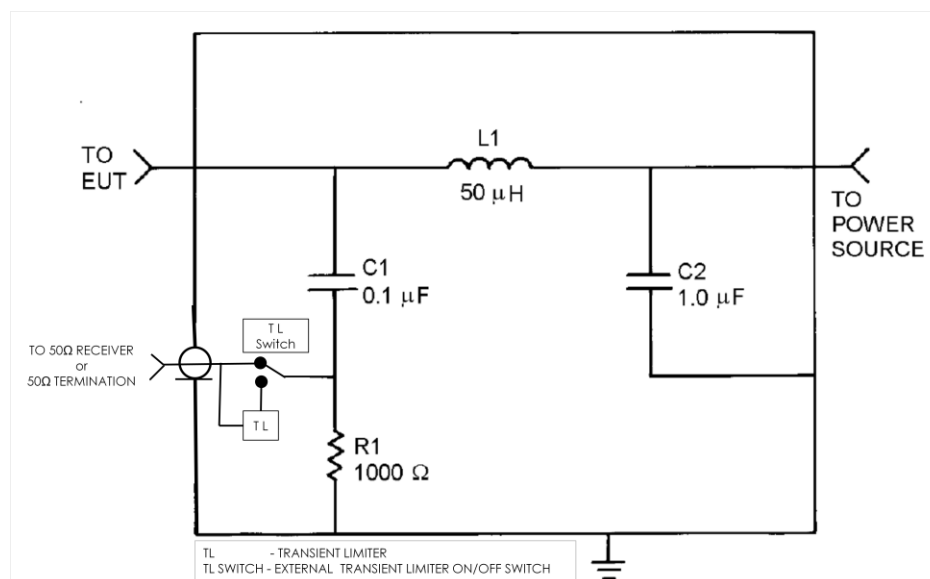
## 6.0 LISN THEORY

Line Impedance Stabilization Networks provide standardized line impedance to the EUT during conducted emissions testing which is independent of the external power line impedance. The standardized impedance enables consistent readings for RF noise measurements on the power line. The model LIN-120C consists of two separate LISN networks housed in a single enclosure for testing EUTs with single phase power requirements.

In addition to providing standardized impedance, the LISN also acts as a low pass filter for the power to equipment under test. The LISN blocks RF noise from the power line from reaching the equipment under test, however, the power to the equipment passes through the LISN with minimal attenuation. This filter is comprised of a single stage low pass LC filter. The inductors (L) used in the LIN-120C are air core type to eliminate the possibility of saturation and to provide stability.

The LISN also provides a low impedance path for the RF noise from the EUT to the measuring equipment, thereby facilitating the measurement of the EUT RF noise. The insertion loss factors provided with every LISN network. It may be significant at low frequencies; especially below 400 kHz. Therefore, the insertion loss correction factors should always be considered for the highest measurement accuracy.

Example schematic of the LISN as well as the respective impedance requirements are specified in the ANSI C63.4 and CISPR-16-1-2 standards. CISPR 16-1-2 also specifies additional requirements for phase performance and Mains port isolation. A typical circuit diagram including the transient limiter is given in figure below.



**Figure 5: Example of equivalent LISN circuit**

## 7.0 TYPICAL PERFORMANCE DATA

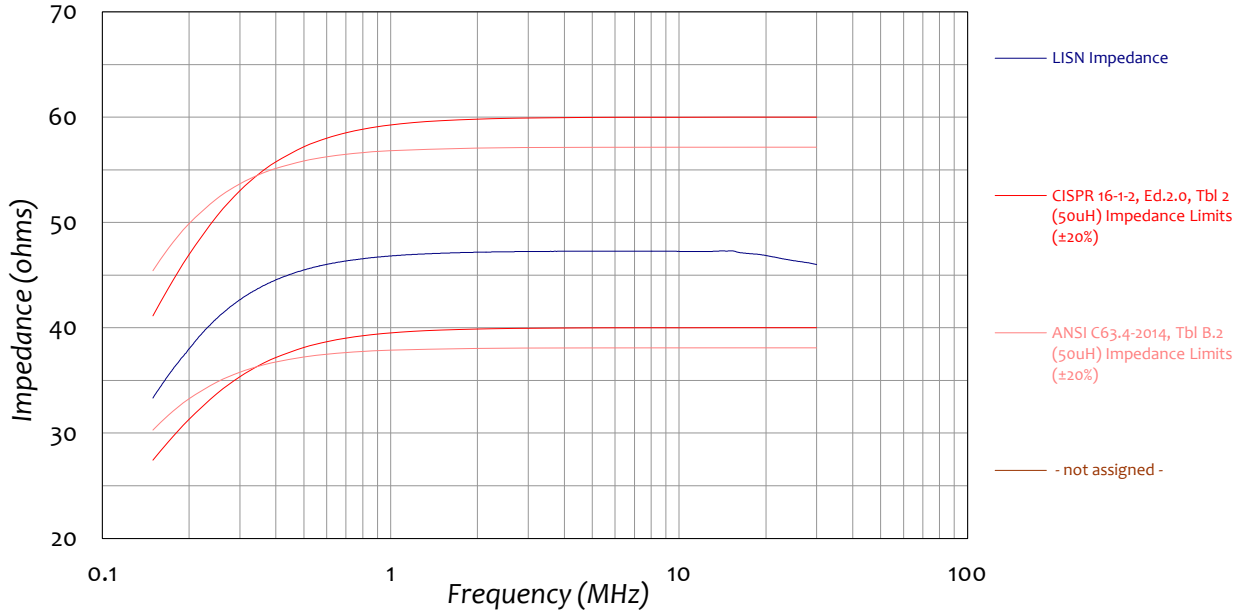


Figure 6: Typical Impedance compared to ANSI C63.4 & CISPR 16-1-2 requirements

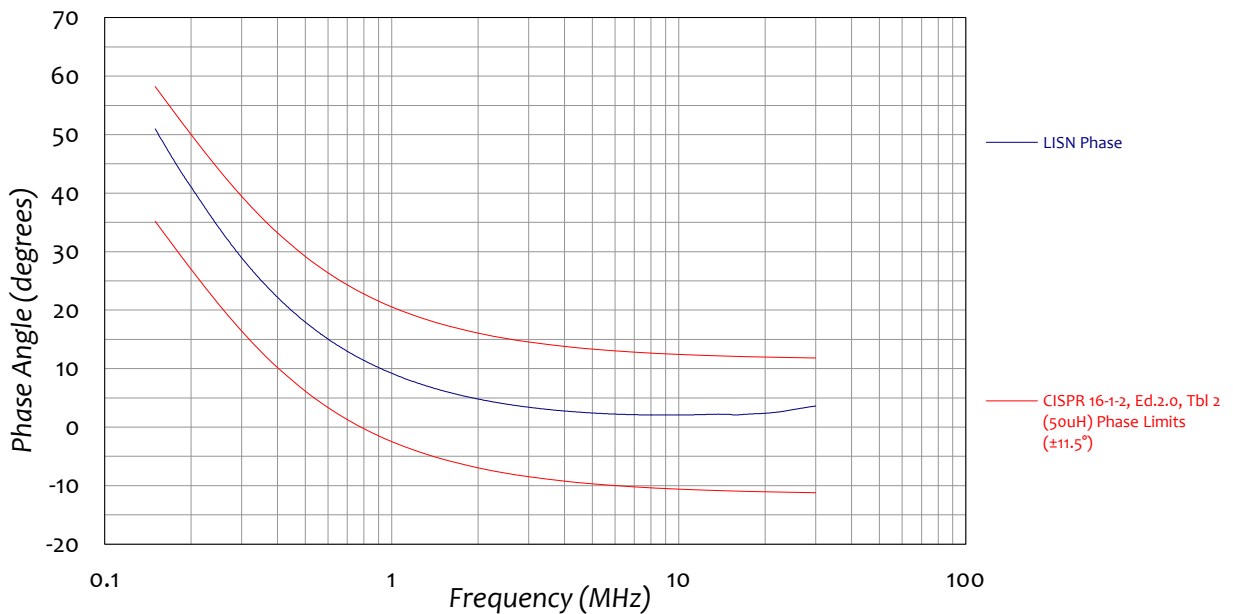


Figure 7: Typical Phase compared to CISPR 16-1-2 requirements.

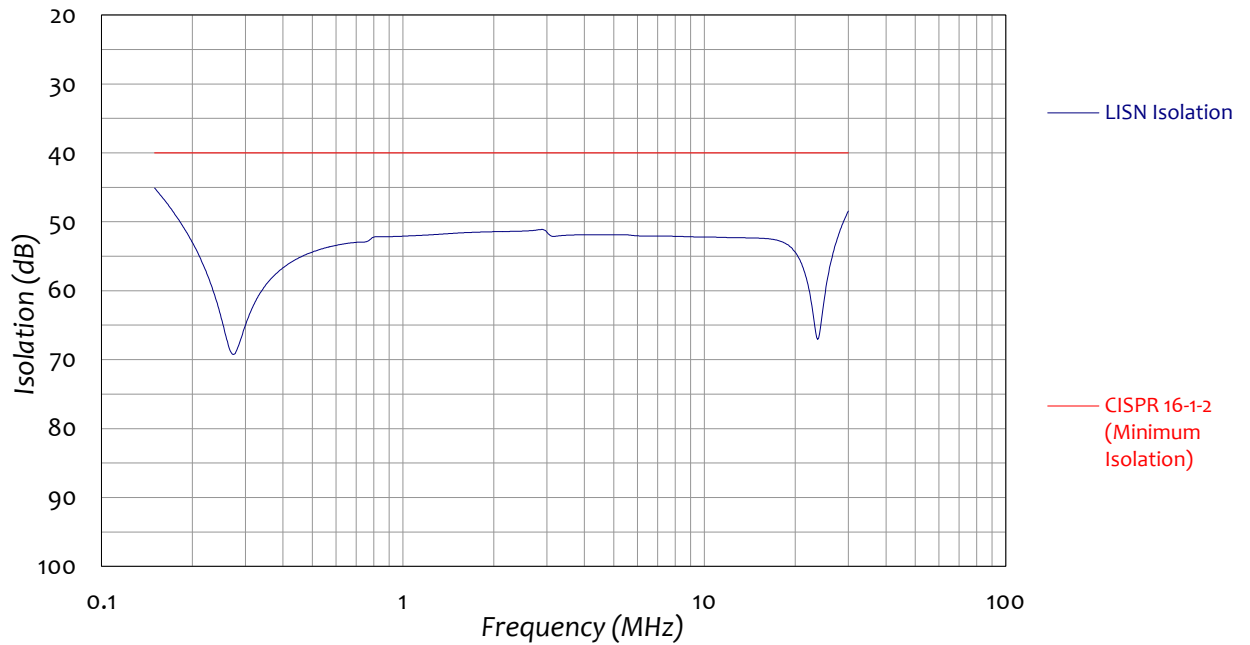


Figure 8: Typical Isolation compared to CISPR 16-1-2 requirements

LINE IMPEDANCE STABILIZATION NETWORK (LISN)- INSERTION  
 CISPR 16-1-2 and ANSI C63.4

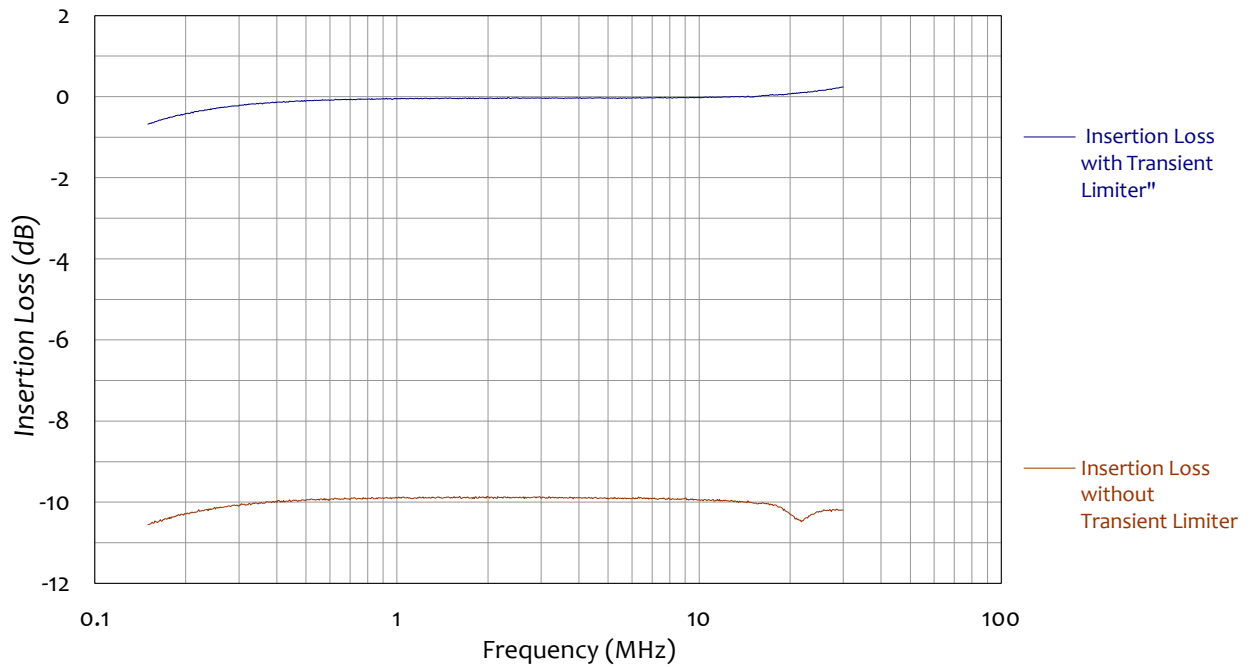


Figure 9: Typical Insertion Loss

## 8.0 WARRANTY

Com-Power warrants to its Customers that the products it manufactures will be free from defects in materials and workmanship for a period of three (3) years. This warranty shall not apply to:

- Transport damages during shipment from your plant.
- Damages due to poor packaging.
- Products operated outside their specifications.
- Products Improperly maintained or modified.
- Consumable items such as fuses, power cords, cables, etc.
- Normal wear
- Calibration
- Products shipped outside the United States without the prior knowlege of Com-Power.

In addition, Com-Power shall not be obliged to provide service under this warranty to repair damage resulting from attempts to install, repair, service or modify the instrument by personnel other than Com-Power service representatives.

Under no circumstances does Com-Power recognize or assume liability for any loss, damage or expense arising, either directly or indirectly, from the use or handling of this product, or any inability to use this product separately or in combination with any other equipment.

When requesting warranty services, it is recommended that the original packaging material be used for shipping. Damage due to improper packaging will void warranty.

If you feel that the product is not working as intended, or is malfunctioning, please contact Com-Power for assistance. In the case of repair or complaint, Please visit our website [www.com-power.com](http://www.com-power.com) and fill out RMA form (<http://com-power.com/repairservicereq.asp>). Our customer service personnel The RMA number should be displayed in a prominent location on the packaging and on the product, along with a description of the problem, and your contact information.

## 8.1 Maintenance

This product contain no user serviceable parts inside. If the unit does not operate or needs calibration, please contact Com-Power Corporation. Any modifications or repairs performed on the unit by someone other than an authorized factory trained technician will void warranty.

The exterior surface may be cleaned with mild detergent and then be wiped with a dry, clean, lint-free cloth. Use care to avoid liquids or other foreign objects entering the chassis.