

HT-S Series

Dielectric Withstand Tester With Ground Continuity Check

Instruction Manual for Models

HT-2000S (0-2000VAC)

HT-2800S (0-2800VDC)

HT-3000S (0-2000VAC/0-2800VDC)

HT-4200S (0-3000VAC/0-4200VDC)



Call Us 1.877.571.7901

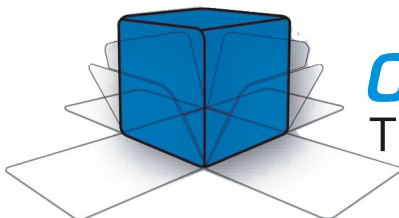

COMPLIANCE WEST USA

The blue box that tests. And tests.

Dear Customer:

Congratulations! Compliance West USA is proud to present you with your Dielectric Withstand Tester. Your instrument features a groundbreaking logic-controlled circuit design and ergonomic front panel, and represents the latest in high voltage production line testing.

To fully appreciate all the features of your new meter, we suggest that you take a few moments to review this manual. If the need arises, please don't hesitate to call on us.

Thank you for your trust and confidence.

Table of Contents

Section 1.....	6
Introduction and Safety.....	6
An Introduction to Dielectric Withstand Testing with the HT-S.....	6
Safety Precautions.....	6
Test Personnel.....	7
Testing Area.....	7
Safety Techniques.....	7
Safety Markings.....	8
Using the HT-S Dielectric Withstand Tester.....	9
Ground Continuity.....	9
Ground Continuity Failures.....	9
Defeating the Ground Continuity.....	9
Leakage Test.....	10
Sporadic Leakage Current Failures.....	10
Chronic Leakage Current Failures.....	10
High Voltage Dielectric Withstand Test.....	11
High Voltage Dielectric Withstand Test Failures.....	11
High Voltage Discharge.....	11
Testing Equipment with non-Standard Plugs or Pigtail Operation.....	11
Section 2.....	12
Specifications and Controls.....	12
Introduction.....	12
Front Panel Features.....	14
Front Panel Features.....	17
Options.....	19
Isolation Relay Interface (PN:00-RI).....	19
Interlock (PN:00-XI).....	19
Section 3.....	20
Operating Instructions.....	20
Setting up your Tester.....	20
AC Line Voltage Requirements.....	20
Fuse Replacement.....	21
Initial Checkout Procedure.....	21
High Voltage Performance Test.....	21
Ground Continuity Performance Test.....	21
Excess Leakage Performance Test.....	22
Hipot Breakdown Performance Test.....	22
Setting up the HT-S for Production Line Testing.....	23
Factory Settings.....	23
Display Setting Limits for Leakage, Time and Ground Continuity.....	24
Adjustment of the High Voltage Level.....	24
Adjustment of the High Voltage Test Time.....	24
Adjustment of the Leakage Current Level.....	24
Adjustment of High Voltage Ramp Time.....	25
Setting the Ground Check Switch.....	25
Adjustment of the Ground Continuity Limit.....	25
Adjustment of Ground Continuity Offset.....	26
Ground Continuity Resistance Measurement.....	27
Operation Techniques.....	27
Testing.....	27
Testing a Device with 3-Wire Power Supply Cord.....	28
Testing a Device with 2-Wire Power Supply Cord.....	29
Section 4.....	30

Technical Assistance.....30
 Contact Information.....30
Section 5.....31
 Maintenance and Calibration31
 Service Information31
 Cleaning.....31
 Calibration Information31



Call Us 1.877.571.7901

Section 1

Introduction and Safety

An Introduction to Dielectric Withstand Testing with the HT-S

The continuity test/dielectric withstand test is a production line test which is recognized by safety agencies worldwide as a valid criterion of safe assembly of end-use equipment. The test ensures that the primary circuit power and ground conductors were properly wired and connected for safe operation. It also applies a high-voltage potential between power and ground conductors to make sure that no unintentional leakage or arcing paths exist between power and ground. The test consists of a ground continuity check, a leakage current check and a high voltage check. It is non-destructive to the equipment under test, and can be accomplished in a short time.

The purpose of dielectric testing: Dielectric testing is a simple, non-destructive method of verifying the adequacy of electrical insulation to withstand the sort of transients that can occur during transient (surge) events. In addition, the dielectric test can verify that the insulation in question has an adequate amount of performance "headroom". This is necessary to ensure that the insulation does not fail because of degradation of the insulation due to aging, moisture, wear due to vibration, etc.

The method of dielectric testing: A high voltage (typically 1000 Volts or higher) is applied between two conductors that are "supposed" to be electrically insulated from each other. If the two conductors (an insulated "live" wire, and a metal enclosure, for example) are completely isolated from each other, then the application of a large voltage difference between the two conductors will not allow current to flow between the conductors. The insulation will "withstand" the application of a large voltage potential between the two conductors - hence the term "dielectric withstand test". In general, there are two results of the test that are considered a failure of the insulation: (1) excessive current flow during the test due to low insulation resistance of the insulating material which separates the two conductors, and (2) an abrupt dielectric breakdown due to electrical arcing or discharge, either through the insulation material, over the surface of the insulation material, or a discharge through air.

The determination of a suitable test voltage: If the test voltage is too low, the insulation material in question will not be adequately stressed during the test. This could cause inadequate insulation to pass the test, and be considered acceptable. On the other hand, if the test voltage is too high, then the test could cause permanent damage to an insulation material that is otherwise adequate for the application. A general "rule of thumb" that is used for the testing of mains wiring which operates at voltages of 120-240Vac is 1000V plus two times the operating voltage. Using this rule, 120V wiring would be tested using a voltage of 1240Vac.

Duration of the test: Generally, the test voltage is applied for one minute, in order to adequately stress the insulation. Many standards allow the test duration to be reduced to 1 second for production-line testing in order to accommodate large-volume production testing. In this case, standards quite often require that the test voltage be increased by 20% in order to ensure that the shorter test duration of one second will adequately test the insulation in question.

Safety Precautions

The dielectric withstand test generates voltages of up to 2000 Volts AC (HT-2000S & HT-3000S), up to 3000 Volts AC (HT-4200S), up to 2800 Volts DC (HT-2800S & HT-3000S) or up to 4200 Volts DC AC (HT-4200S) at potentially lethal current levels. Currents of as little as 5 mA at 120V can cause death, and the HT-S is capable of generating 20mA AC at up to 2000 Volts (10mA at up to 3000Volts for HT-4200S), and 5mA DC at up to 2800 Volts (up to 4200 Volts for HT-4200S). The HT-S has been designed to minimize exposure to high voltages. However, the potential for serious injury or death exists and personnel should be aware when they conduct this test.

Any use of this equipment other than as specified in this manual may result in a safety hazard.

Test Personnel

Personnel require special training to conduct the dielectric withstand test. They should understand electrical fundamentals clearly, and be aware that high voltage is adept and creative at completing a path to ground. Instructions should include a warning against any metal jewelry. Operators should not allow others in the testing area, especially when tests are being conducted. Organization is to be stressed. The operator should keep the area free of unused leads and equipment.

Testing Area

The area used for conducting the dielectric withstand test should be as remote as possible from normal production line activities. Only personnel actually conducting the test should be allowed in the area, and it should be taped or roped off to preclude casual entry by other employees. In addition, the area should be marked "WARNING - HIGH VOLTAGE TESTING" or the equivalent to warn others of the nature of the testing taking place.

The bench being used should be non-conductive, and any exposed metal parts should be tied together and grounded. If a conductive surface must be used, it should be grounded.

Because of sparking during a dielectric test failure, it is not safe to conduct dielectric withstand tests in combustible atmospheres.

It is imperative that a good ground be provided to the HT-S unit. Before connecting the HT-S, ensure that a low-resistance ground is provided by the building wiring. If the HT-S is used on a high-resistance grounding circuit, dangerous high voltages may be present to the operator. In addition, the power to the Testing Area should be provided with an easily reached shutoff switch which can be actuated by personnel outside the area if needed.



Safety Techniques









The high voltage circuit of the HT-S can be shut off at any time by pressing the **RESET** button. The HT-S has been provided with a Reset button to provide an unarmed "Standby" setting when it is energized, but idle. When the red **RESET** light is lit the tester will not provide high voltage until the **RESET** button and the **TEST** button have been pressed in order. To prevent inadvertent operation, the operator should be instructed not to press the **RESET** button until the test is finish.

The HT-S is equipped with a ground continuity check which will not allow high voltage to be applied if the Test Return Lead is not properly connected. This is an important safety feature and should not be defeated unless two wire products are being tested. In that event, it is imperative that the operator make absolutely sure the Test Return Lead is properly connected to the equipment being tested. If the lead is not properly connected, a dielectric withstand test failure may energize exposed dead metal of the equipment being tested. Additionally, the HT-S may not recognize the failure. The test will continue for its normal length of time, and the HT-S may show a "PASS", see connections for more details.

The HT-S has been designed for one-touch operation with the right hand. If possible, it should be set up to the left and in front of the equipment under test. The equipment under test should be connected to the HT-S and then left alone by the operator. After the operator is clear of the Tester and the equipment under test, he should press the **RESET** Button, then the **TEST** button, with his right hand. This will allow the greatest separation between the operator and the test being conducted.

The HT-S is designed to bleed the high voltage away after the test has concluded. In order to ensure that any voltage present in the equipment being tested has been completely bled away, the operator should not unplug the equipment under test from the HT-S until the front panel meter reads zero volts.

Safety Markings

	Direct Current		On (Power)
	Alternating Current		Off (Power)
	Earth (ground) TERMINAL		Caution, possibility of electric shock
	Refer to instructions		High Voltage

Using the HT-S Dielectric Withstand Tester

The dielectric withstand test involves high voltage and caution should be exercised when using the tester. The return lead of the tester is connected to ground potential and when properly connected to the equipment being tested, it will guard against the operator contacting high voltage. Always make sure the return lead is firmly connected to exposed dead metal before start testing. To make sure if the connections between the dielectric withstand tester and the equipment under test is correct, see the Testing section for more detail. In the sections below, the three tests are explained.

Ground Continuity

The ground continuity test ensures that the grounding pin of the power supply cord is properly connected to the exposed dead metal of the chassis. If this connection is absent, the exposed dead metal of your product could be at line potential indefinitely after an internal wiring fault, causing risk of shock to anyone touching it.

If the green **Ground OK** LED light is on, the connection between the grounding pin and the exposed dead metal of the equipment being tested has a resistance lower than adjusted on the rear panel.

Ground Continuity Failures

If the red **Ground Open** LED light is on, the buzzer sounds, and the test is terminated. The connection between the grounding pin and the exposed dead metal of the chassis has a resistance higher than the indicated in the ground setting. This indicates a problem with the connection of the HT-S to the equipment being tested, or that the ground connection in the equipment being tested is defective. The connection to the tester should be checked by removing the Test Return Lead clip from the equipment under test and reconnecting it, taking care to make a good connection. The unit should then be retested. If a failing result is repeated, the connection between the power supply cord ground pin and the chassis of the equipment being tested should be checked and reworked until a passing result is obtained.

Defeating the Ground Continuity

The ground continuity can only be conducted on equipment using a three wire grounded power supply cord. Some equipment, such as most portable lamps and all double insulated tools, have only a two wire power supply cord, so the Ground Continuity test cannot be conducted.

Please note that defeating the Ground Continuity should not be done except when necessary to test two-wire devices. The Ground Continuity feature provides an extra level of operator safety because high voltage will not be applied if the Test Return Lead is not properly connected to the exposed dead metal of the equipment being tested. If the Test Return Lead is not properly connected, a dielectric withstand failure may energize exposed dead metal. Additionally, the HT-S may not recognize the failure. The test will continue for its normal length of time, and the HT-S may show a "PASS".

To allow the HT-S to test equipment using a two wire power supply cord, the Ground Continuity test can be defeated by turning the rear panel Ground Check switch to the Off position. To remind the operator that the Ground Continuity test is not being conducted, both the green **Ground OK** and red **Ground Open** LED's will be lit continuously during the test. When testing with the Ground Check switch in the Off position, the operator must ensure that the Test Return Lead is properly connected to exposed dead metal of the equipment being tested for safety and to ensure that the HT-S properly reports all failures.

Leakage Test

The HT-S leakage test uses a low-frequency circuit to check for excessive leakage between primary power components and ground. There is not a specific leakage current level pass/fail requirement at this time for most equipment, however, higher than normal leakage current on a particular part may indicate an assembly or component problem in the primary circuit.

The leakage current is also monitored by the HT-S to ensure that excessive leakage does not keep the tester from developing full voltage required for the high voltage test. The HT-S will provide full voltage at any leakage current level up to 20 mA AC (HT-2000S & HT-3000S), up to 10mA AC (HT-4200S) or 5mA DC (HT-2800S, HT-3000S & HT-4200S). The leakage current trip level is adjustable on the rear panel.

The leakage test is conducted by shorting the line and neutral conductors of the power supply cord and applying high voltage between them and the exposed dead metal of the chassis of the equipment being tested.

Excessive leakage current is not grounds for failure of the dielectric withstand test. Leakage current is a normal result of capacitance in the primary circuit between neutral or line conductors and ground. (In dielectric tests of some larger electric motors, leakage currents of as high as 95 mA are considered acceptable by safety agencies.) However, leakage currents higher than normally anticipated for a particular model should not be ignored. This indicates problems of low resistance up to a short circuit between line/neutral and ground, and failures should be investigated. Failure modes are discussed below.

If the green **Full Voltage** LED light is on and the test continues, the leakage current is below the limit set by the rear panel adjustment.

Sporadic Leakage Current Failures

If the red **Excess Leakage** LED light is on, the buzzer sounds, and the test is terminated, the leakage current delivered to the equipment being tested was over the limit set by the rear panel adjustment. If other equipment of the same type routinely passes this test, there may be a problem with the primary circuit of the example being tested. The unit should be checked and reworked if necessary.

Chronic Leakage Current Failures

AC Dielectric Withstand testing, charges all primary circuit capacitors connected line to ground or neutral to ground. The current flowing through these capacitors is defined as leakage current. If almost all examples of a model of equipment are not passing the leakage current test, we recommend that the leakage current limit be increased by resetting the leakage current level on the rear panel to a higher level.

If the leakage current adjustment of the HT-S is set to 20mA AC and almost all examples of the model being tested are still failing, the primary circuit capacitance of the equipment may be too high to allow the AC dielectric withstand test to be used. This is due to the AC voltage charging all capacitors connected between primary voltage and ground. If the overall value of these capacitors cause a leakage current of more than 20mA to flow at the desired test voltage, the HT-S cannot generate full voltage, and cannot successfully conduct the dielectric withstand test.

However, a DC dielectric withstand test is acceptable for most categories of equipment and will not charge the primary circuit capacitors. The DC test can be conducted by switching the front panel switch to DC (only HT-3000S or HT-4200). If the problem was due to high leakage current on the capacitors of the circuit, the test should now be successful.

High Voltage Dielectric Withstand Test

This test checks for insulation system breakdowns between the primary and ground circuits. The HT-S uses a separate high-frequency transformer circuit to detect arc breakdowns.

The dielectric withstand test is conducted by shorting the line and neutral conductors of the power supply cord and applying high voltage between them and the exposed dead metal of the chassis of the equipment being tested. The duration of the test is controlled by the test time control on the back panel. The test time is counted from the time the **Full Voltage** LED is lit to the completion of the test.

If the green **Hipot Pass** LED light is on, the test cycle has been successfully completed. The equipment under test is in accordance with the preset test parameters. The HT-S is ready to test the next piece of equipment.

High Voltage Dielectric Withstand Test Failures

If the red **Hipot Fail** LED light is on, a problem has been found with the insulation between primary and ground. The equipment under test should be examined, reworked and successfully tested before being shipped.

High Voltage Discharge

The HT-S is designed to discharge the high voltage after completion of the dielectric withstand test. The equipment being tested should remain connected to the HT-S until the voltage has discharged to a safe level to protect the operator and also to ensure that there is no energy stored in the tested equipment.

Testing Equipment with non-Standard Plugs or Pigtail Operation

The front panel of the HT-S is provided with a NEMA Type 5-15R receptacle, suitable for testing cord-equipped single-phase products designed for use on a 15 amp branch circuit in North America. For other types of products, a different receptacle type or pigtail leads may be required. Various adapters and pigtail leads are available from Compliance West USA, or you can make your own, just make sure for the correct configuration see the description of the outputs in the connections section. If tests of this type are contemplated, call us for information.

Section 2

Specifications and Controls

Introduction

This manual contains complete operating, maintenance and calibration instructions for the models HT-2000S, HT-2800S, HT-3000S and HT-4200S Dielectric Withstand Testers, please see Table 1 for specifications.

The instrument is a bench-type Dielectric Withstand Tester with AC and/or DC Output, designed for production line testing. The HT-S features automatic one button operation, with numerous safety features designed to protect the operator:

The Return Lead is directly connected to ground potential for operator safety. Test can be immediately terminated at any time by pressing the **RESET** button. Before the test can commence, the unit must be armed by pressing the **RESET** Button. The test will not begin until the **TEST** button is pushed.

If a failure is encountered, the high voltage is immediately shut down, a buzzer sounds, and any voltage stored in the equipment being tested is bled off by a resistor bank in the HT-S unit. The voltage discharge progress is shown by the front panel meter. Failure modes are shown by the front panel LED's for quick troubleshooting.

Convenience and testing features include:

- a. Test results are determined quickly, without operator intervention.
- b. Operator instructions are printed on the rear panel for quick reference.
- c. The HT-S allows custom setups for Voltage Ramp time, Test time, Leakage limit and Ground Continuity limit.
- d. The Ground Continuity test can be defeated by a switch on the rear panel for testing of products using a two wire power supply cord.
- e. DC Voltage is discharged by a resistor bank within the HT-4200S, HT-3000S or HT-2800S upon test completion. Discharge progress is shown on the front panel meter.
- f. The HT-S meets all safety agency criteria for automatic production line Dielectric Withstand Testers.
- g. Your Tester is warranted for a period of one year upon shipment of the instrument to the original purchaser.

Table 1. HT-S Specifications

ELECTRICAL	0 - 2000 Volts AC HT-2000S, HT-3000S
Voltage Output	0 - 2800 Volts DC HT-2800S, HT-3000S 0 - 3000 Volts AC HT-4200S 0 - 4200 Volts DC HT-4200S Pigtail and Receptacle adapters available for most configurations. Contact Compliance West for more information.
Leakage Current	1 - 10mA AC HT-4200S 1 - 20mA AC HT-2000S, HT-3000S 1 - 5mA DC HT-2800S, HT-3000S, HT-4200S
Pass/Fail Criteria:	Pass/Fail Point:
Ground Continuity:	User adjustable: 0.08Ω -1.50Ω ±0.02Ω. User non-adjustable: 3Ω ± 5% *(Optional & defeatable)
Leakage Current:	Pass/Fail point user adjustable.
Dielectric Breakdown:	Separate high frequency detection circuit for breakdown spike detection
Test Time:	User adjustable 1-60 sec.
Voltage Ramp-up Time:	User adjustable 1-5 sec.
Discharge Time	< 7 ms for AC < 1.3 s for DC
Meter accuracy	± 2% from 500V to maximum limit voltage
Duty cycle	100%
Test adjustments	Rear Panel: Ramp Time Test Time Leakage Limit Voltage Adjust Ground Continuity Defeat Switch Ground Continuity Limit Ground Continuity Offset Tamper proof operation available by removing adjustment shafts.
ENVIRONMENTAL	
Operating Temperature	15-40°C
Relative Humidity Range	0-90% non-condensing
Altitude	0-3000 meters
	Pollution Degree II (indoors, office/laboratory)
GENERAL	
Input Voltage, Current	120V ±10%, Overvoltage Category 2, 0.5A
Fuse rating	1A 250V "T" (Time Delay)
Weight	11 lbs approx.
SAFETY AGENCY TOPICS	
Transformer Output	< 500VA
Visual Indication of Voltage Output	Provided by front panel meter, directly connected to high voltage output
Failure Indication	Audible, provided by internal buzzer Visual, provided by red LEDs on front panel Test automatically terminated on failure
Ground Continuity Test	Provided; 1.5Ω factory set Pass/fail point. May be defeated for testing of products with two wire power supply cords.
Leakage Test	Provided; 5mA AC/2mA DC factory set pass/fail point, user adjustable.
Operation Instructions	Provided on rear panel.

*Ground Continuity Pass/Fail Level can be adjusted from .5 to 5Ω during the calibration procedure.

Front Panel Features

Before using the HT-S tester, take a few minutes to become familiar with the use of its controls, indicators, and connectors. The front panel features of the HT-S are shown in Figure 1 and Figure 2 then described in Table 2.

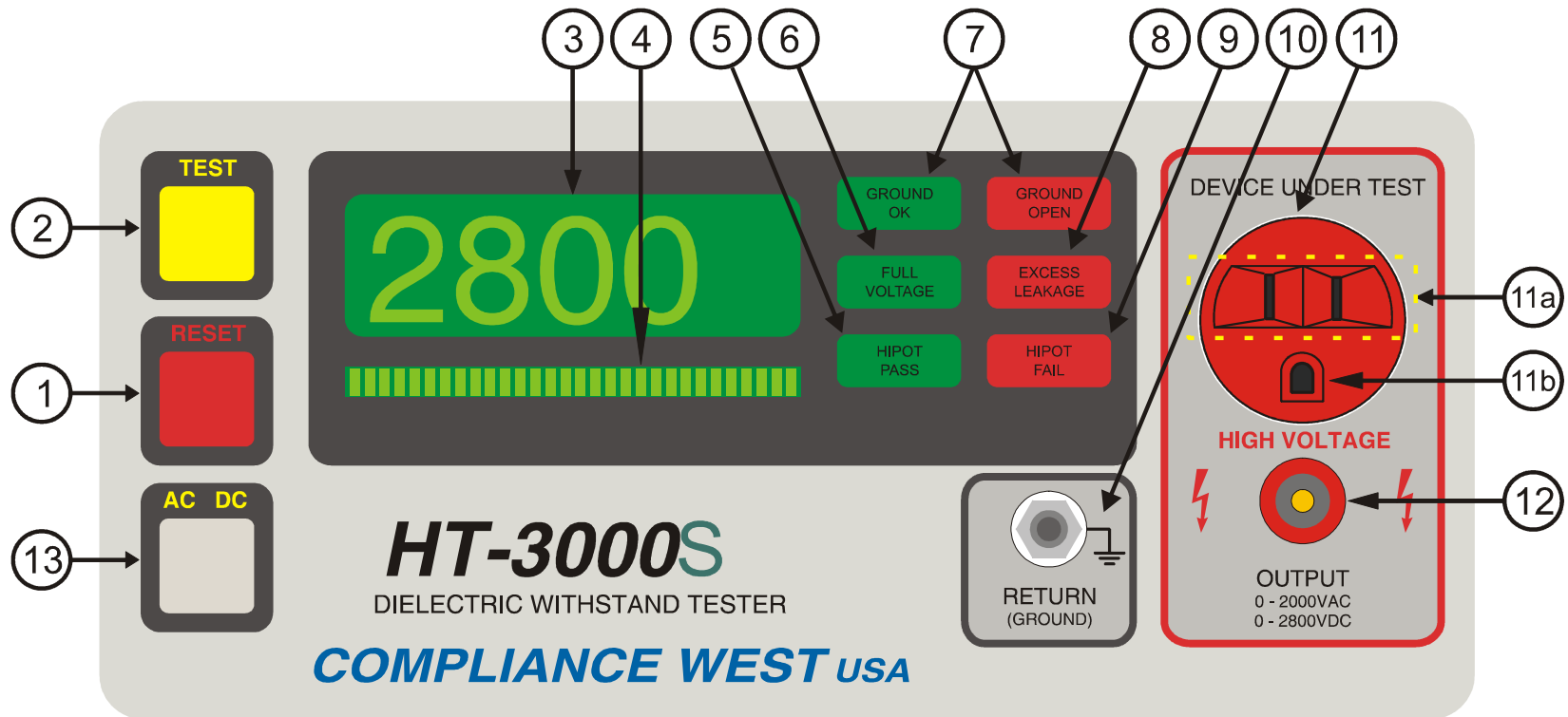

Figure 1. Front Panel Controls, Indicators and Connectors for HT-3000S, HT-2800S and HT-2000S.

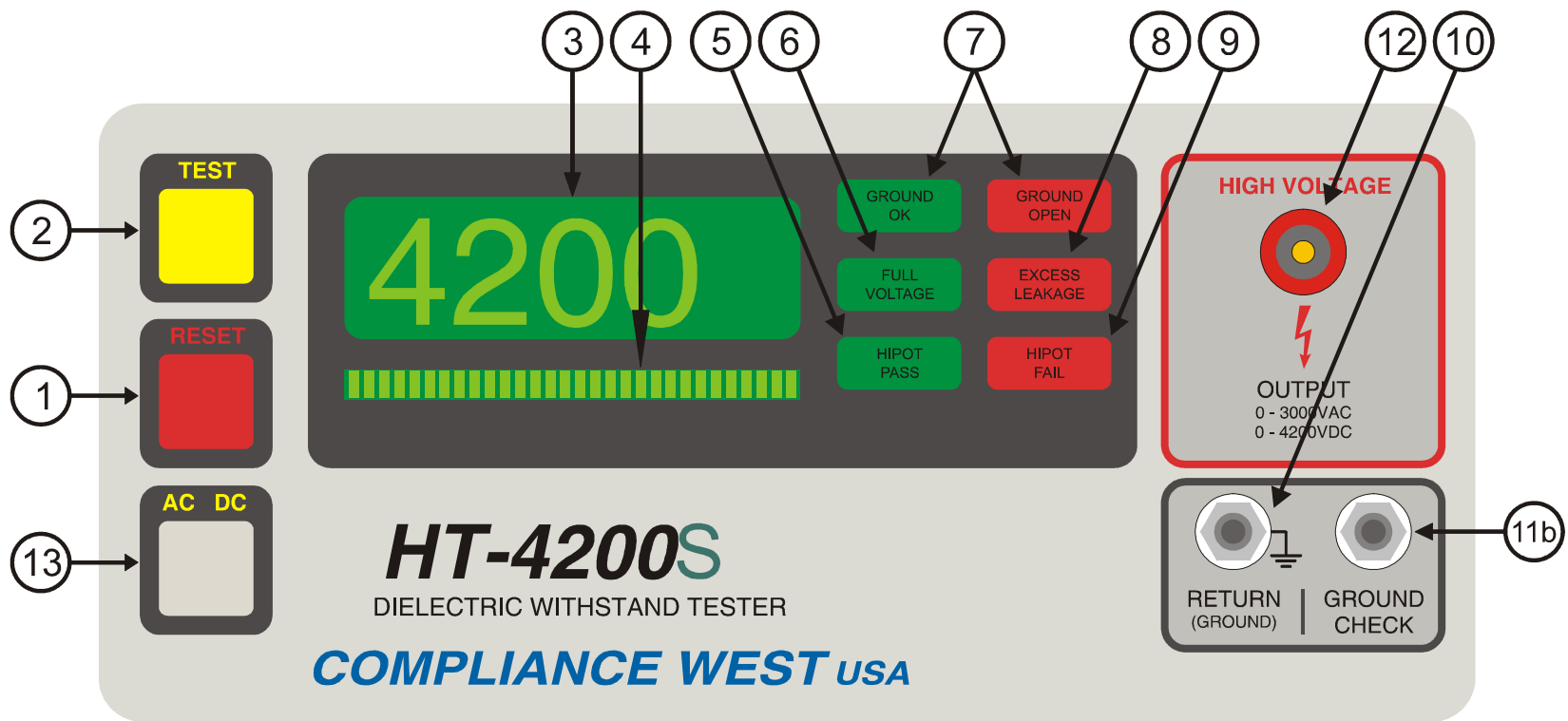

Figure 2. Front Panel Controls, Indicators and Connectors for HT-4200S.

Table 2. Front Panel Controls, Indicators and Connectors.

ITEM	NAME	FUNCTION
1	RESET Button / Red Indicator	When lit, indicates that the HT-S tester is unarmed. This button must be pushed before the TEST button is functional. When the RESET button is pressed, the red RESET indicator goes out and the yellow TEST indicator is lit. PRESSING THE RESET BUTTON AT ANY TIME STOPS THE TEST.
2	TEST Button / Yellow Indicator	When lit, indicates that the HT-S tester is ready to test the connected equipment. The yellow TEST indicator goes out when the TEST button is pressed.
3	Voltage Meter	Provides visual indication to the operator of the actual output voltage of the HT-S tester. Used to set the test voltage level during the setup procedure.
4	Ramp Bar Graph LED's	Individual LED's light in sequence from left to right as the test voltage ramps from zero to full voltage. LED's turn off (ramp back down) at end of test.
5	Hipot Pass LED	At the end of the preset high voltage duration time, if no failures are encountered, the green light will light and the test will terminate.
6	Full Voltage LED	If full voltage is successfully reached, the Full Voltage LED will light and the high voltage duration timer starts.
7	Ground OK / Ground Open LED's	Indicates result of Ground Continuity test between grounding pin of the line cord and exposed metal parts of the equipment under test. If the ground path resistance it is higher than the indicated on the ground setting, or if the leads are not properly connected, the red Ground Open LED will light, the internal buzzer will sound, and the test will be terminated. If the ground circuit resistance is acceptable, the green continuity LED will light and the test will continue. If the Ground Check switch is defeated by the operator, both LED's will be lit for the duration of the test.
8	Excess Leakage LED	Indicates failure of leakage current test. If leakage current between the primary circuit and ground is higher than the preset value, the red LED will light, the internal buzzer will sound, and the test will be terminated.
9	Hipot Fail LED	Indicates failure of high voltage test. If arcing or a flashover of the insulation system between primary parts and ground is encountered, the red breakdown LED will light, the internal buzzer will sound, and the test will be terminated.
10	Return Lead Receptacle	Grounded banana plug receptacle. The 18 AWG Test Return Lead provided is connected here.
11	High Voltage Device Receptacle	NEMA 5-15R orange receptacle. For connection of the equipment under test. See items 11a and 11b for slots description.
11a	High Voltage Output	On the NEMA plug, the two top vertical slots are tie together, the high voltage to perform the Dielectric Withstand test comes true these two slots.
11b	Ground Continuity Measurement Point	On the NEMA plug, the bottom round slot is the ground continuity measured point. Ground continuity test circuit is measured from this slot (Item 11b) to the Return Lead Receptacle (Item 10).
12	High Voltage Test Jack	Red High Voltage jack. For connection of high voltage test lead for testing insulating materials, etc. This High Voltage Jack is standard on models HT4200S and HT-3000S, and optional on models HT-2800S and HT-2000S
13	AC/DC Switch	Selects AC or DC output. Changing switch setting does not change output until the next time the Reset button is pushed. This option is only available on <i>HT-3000S</i> & <i>HT-4200S</i> model.

Front Panel Features

Before using the HT-S tester, take a few minutes to become familiar with the use of its controls, indicators, and connectors. The rear panel features of the HT-S are shown in Figure 3 and described in Table 3.

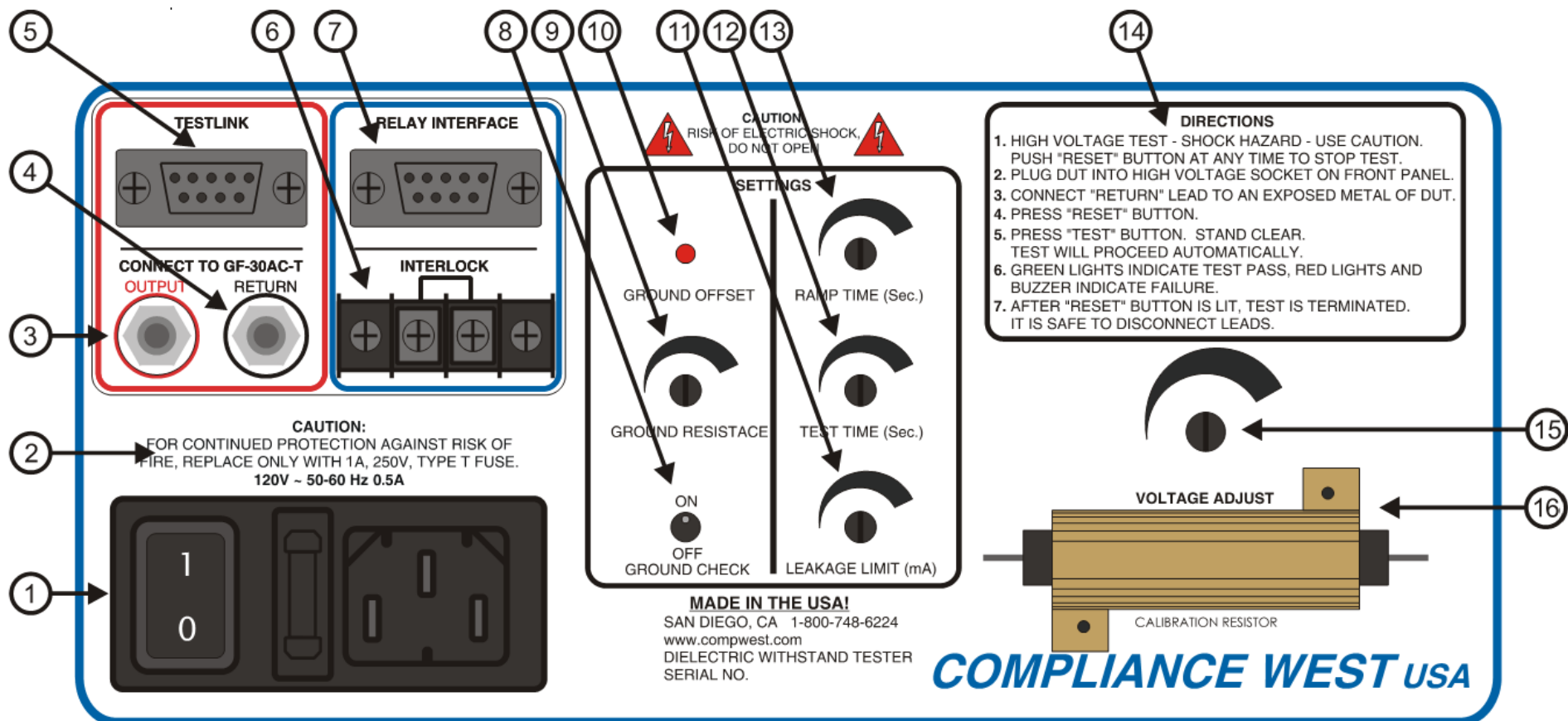

Figure 3. Rear Panel Controls, Indicators and Connectors

Table 3. Panel Controls, Indicators and Connectors.

ITEM NO.	NAME	FUNCTION
1	Appliance Inlet / Fuse holder / Power Switch	Use supplied cord set to connect tester to appropriate source of supply. Replace line fuse. Turn Tester ON/OFF. Power switch must be accessible during operation
2	Fuse replacement warning / Rating of supply	Specifies replacement fuse and required supply voltage.
3	Testlink OUTPUT Receptacle	The Output Testlink Cableset lead is connected here. The cableset is included when you get Testlink option.
4	Testlink RETURN Receptacle	The Return Testlink Cableset lead is connected here. The cableset is included when you get Testlink option.
5	Testlink	Allows connection with GF-30AC-T for Ground Bond Test. A cableset is included when you get this option.
6	Interlock	This is a safety feature, when in short-circuited the HT works regular, when open stops immediately its function.
7	Relay Interface	Relay Interface/PLC Interface. Test signals through relay contacts/coils (Optional).
8	Ground Check Switch	Enables or disables the Ground Continuity test. Turn ON for use with three-wire (grounded) power supply cords. Turn OFF for use with two-wire power supply cords. (When ON, conducts Ground Continuity test between the chassis and the grounding pin of the line cord of the equipment being tested. When OFF, Ground Continuity test is bypassed for testing of double-insulated equipment and other types of equipment without a grounding pin in the line cord.)
9	Ground Resistance Setting Adjustment	Used to adjust the Ground Continuity pass/fail point setting. See "Ground Continuity" on the Adjustment section for more information
10	Ground Offset Button	This button can perform two different functions. Pressing and holding it for 1 second, the HT-S will measure and display on the front display the Ground Continuity resistance of the EUT under test. Pressing and holding the button for 5 seconds will compensate the resistance of the test cables of fixture, see "Ground Continuity Offset Adjustment" and "Ground Continuity Resistance Measurement" sections for more details.
11	Leakage Limit Adjustment	Used to adjust the trip level for the excessive leakage current test. See "Leakage Current Level" on Adjustment section for more information.
12	Test Time Adjustment	Used to adjust high voltage test duration. See "Adjustment of the High Voltage Test Duration" section for this procedure.
13	Ramp Time Adjustment	Used to adjust the amount of time used to increase the high voltage from zero volts to the required level. See "High Voltage Ramp Time" on Adjustment section for correct procedure.
14	Directions	Provides directions for tester operation to test personnel.
15	Voltage Adjust	Used to adjust the High Voltage output. See "High Voltage Level" on the Adjustment section for correct procedure.
16	Calibration resistor	This resistor (optional) may be used to verify the leakage current.

Options

Isolation Relay Interface (PN:00-RI)

The Isolation Relay Interface option is a Female DB-15 connector located on the rear panel of the tester. The Isolation Relay Interface option allows the user to manipulate the machine thru the DB-15 connector using a PLC or any other control system that can supply 5V, 12, or 24V depending on the user specification when purchasing the tester.

The Pin configuration for the Relay Interface is describe in Table 4.

Signal	Pin Number	Type
Start	1	Input
Reset	2	Input
COM1	3	Common
Ground OK	5	Output
Ground Fail	6	Output
Full Voltage	7	Output
Excess Leakage	8	Output
Hipot Pass	9	Output
Hipot Fail	10	Output
Any Failure	11	Output
COM2	12	Common

Table 4. Relay Interface Pin Configuration

Interlock (PN:00-XI)

The Safety Interlock options is a 2 pin terminal block located on the rear panel of the tester. The Safety Interlock has 2 different states; OPEN and CLOSE (SHORT)

OPEN.

When the Safety Interlock is open the TEST and RESET buttons will be disable and the tester will not be able to run a test.

CLOSE (SHORT)

When the Safety Interlock is short the Tester is able to operate and run a test. If the state of the interlock change to open the tester will not be able to run a test again until the state changes back to close.

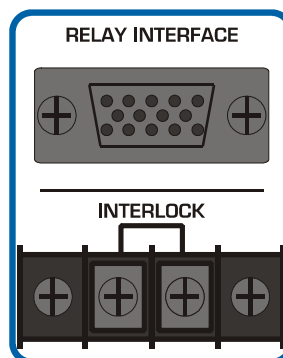

Figure 4. Relay Interface and Interlock connectors

Section 3

Operating Instructions

Setting up your Tester





The HT-S tester is shipped in a special protective container that should prevent damage to the instrument during shipping. Check the shipping order against the contents of the container and report any damage or incomplete shipment to Compliance West USA. The container should include the following, pictures are showed in Table :

- HT-S Dielectric Withstand Tester
- 18 AWG Line Power Cord. Use only a power cord suitable in the jurisdiction where the equipment is operated, and only if its ratings meet or exceed the ratings of the equipment.
- 18 AWG GL Test Lead (Alligator Clip/Banana Plug ends, black)
- Ground Continuity Connector Tip or another 18 AWG GL Test Lead.
- Instruction Manual

Only HT-4200S

- Red 18 AWG High Voltage Test Lead (Alligator Clip/High Voltage jack)

Table 5. Shipment Cables & Connectors

18 AWG Line Power Cord	GL Return Test Lead (QTY. 2 for HT-4200S)	Ground Continuity Connector Tip (Not included for HT-4200S)	Red 18 AWG High Voltage Test Lead (Only HT-4200S)
			

Only accessories which meet the manufacturer's specifications shall be used.

Connect this equipment to grounded outlet only. The integrity of the test system grounding is dependent on building ground.

If reshipment of the instrument is necessary, please use the original shipping container. If the original shipping container is not available, be sure that adequate protection is provided to prevent damage during shipment. We recommend that the instrument be surrounded by at least three inches of shock-absorbing material on all sides of the container.

Remove the tester from its container and place it on a test bench.

AC Line Voltage Requirements

AC line voltage requirements for your tester are noted on the rear panel of the instrument. Do not connect the instrument to a different voltage source, use the power cord and make sure you have a ground connection in your building before you start testing.

Fuse Replacement

There is a user-replaceable fuse (F1) located on the rear panel of the instrument. It is located behind a door in the Inlet-Power Switch-Fuse Holder device. The fuse rating is noted on the rear panel. Do not attempt to replace it with a fuse of any other rating.

Use the following procedure to replace the fuse F1:

1. Turn the power switch to the O or OFF position.
2. Unplug the instrument from the source of supply.
3. Remove the power inlet cord from the instrument.
4. Using a small screwdriver, pry open the fuse holder door.
5. Replace the fuse with a new one of the correct rating.
6. Replace the fuse holder door and power inlet cord.

Initial Checkout Procedure

The following procedure will verify that the HT-S is working correctly. We recommend that this procedure be conducted periodically to ensure proper operation of the tester. (A Compliance West HTT-1 or HTT-1R function tester may also be used to verify the HT-S is working correctly).

The following items are needed to conduct this procedure:

- An 18 AWG GL test lead (Alligator Clip/Banana Plug ends, black).
- Ground continuity connector clip.
- A piece of none insulated jumper wire (Not supplied)

CAUTION

High voltage (up to 2000 Volts AC and 2800 Volts DC or up to 3000 Volts AC and 4200 Volts DC for HT-4200S) generated by the HT-S is exposed during this test. A risk of shock exists. Exercise care when using the HT-S.

High Voltage Performance Test

1. Disconnect all leads of the HT-S front panel.
2. Turn the **Ground Check** switch on the rear panel to the Off position.
3. Push the red **RESET** button. Verify the yellow **TEST** indicator is lit.
4. Push the yellow **TEST** button.
5. The Tester should conduct a test sequence. Confirm on the front meter that the HT-S can reach the High voltage. At the end of the test, the **Ground OK**, **Ground Open**, **Full Voltage**, **Hipot Pass**, and red **RESET** LED's should be lit.

Ground Continuity Performance Test

1. Disconnect all leads of the HT-S front panel.
2. Turn the **Ground Check** switch on the rear panel to the On position.
3. Push the red **RESET** button, then the yellow **TEST** button.
4. The tester should sound the buzzer. The red **Ground Open** and red **RESET** LED's should be lit.
5. Connect the supplied Ground Continuity Connector Tip into the bottom round slot of the orange receptacle located on the front panel or the GL Return Test Lead to the Ground Check receptacle (HT-4200S only).
6. Plug the supplied 18 AWG GL Test Lead (Alligator Clip/Banana Plug ends, black) into the **RETURN** receptacle on the front panel, then, connect the green alligator clip end to the Ground Continuity Connector Tip previously connected on step 5.

7. Push the red **RESET** button and then the yellow **TEST** button.
8. The tester should conduct a test sequence. At test termination, the **Ground OK, Full Voltage, Hipot Pass**, and Red **RESET LED**'s should be lit.

Excess Leakage Performance Test

1. Disconnect all leads of the HT-S front panel.
2. Turn the **Ground Check** switch on the rear panel to the Off position.
3. Plug the supplied 18 AWG GL Test Lead (Alligator Clip/Banana Plug ends, black) into the **RETURN** receptacle on the front panel, then, clamp with the green alligator clip the piece of none insulated jumper wire.
4. Connect one end of the hookup wire to the clip of the black lead and insert the other end into one of the vertical parallel slots in the **DEVICE** receptacle on the front panel. **Keep clear of the wire while the test is in progress.**
5. Push the red **RESET** button and then push the yellow **TEST** button.
6. The tester should conduct a test sequence, terminated with a buzzer. At test termination, the **Ground OK, Ground Open, Excess Leakage**, and red **RESET LED**'s should be lit.

Hipot Breakdown Performance Test

Note: The following procedure tests the "Hipot Breakdown" circuit of the HT-S unit and involves high voltage. The only exposed parts during this test are at ground potential. However, the voltage inside the High Voltage Device socket may be as much as 2000 volts AC or 2800 volts DC or up to 3000 Volts AC and 4200 Volts DC for HT-4200S. Proceed with caution.

1. Disconnect all leads of the HT-S front panel.
2. Turn the **Ground Check** switch on the rear panel to the Off position.
3. Plug the supplied 18 AWG GL Test Lead (Alligator Clip/Banana Plug ends, black) into the **RETURN** receptacle on the front panel, then connect a bent paper clip (not provided) to the green alligator clip on the end of the test lead.

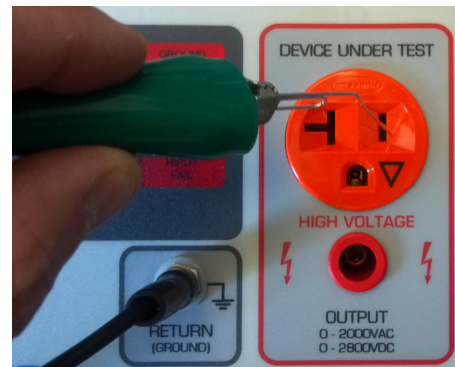

4. Push the red **RESET** button, then the yellow **TEST** button. After the **Full Voltage** LED lights, and before the **Hipot Pass** LED has lit, insert the end of the paper clip into one of the vertical parallel slots in the High Voltage Device receptacle on the front panel. Keep fingers away from the alligator clip and the bare wire.
5. The test should immediately terminate with a buzzer. The **Ground OK, Ground Open, Full Voltage, Hipot Fail** and red **RESET LED**'s should be lit.

Note: Depending on how the connection between the High Voltage Test Receptacle and the hookup wire is made, the **Excess Leakage** LED may light, and in some instances, the **Ground OK** LED may extinguish.

Passage of these tests indicates that the HT-S tester is functioning properly and that it is safe to use. If the results of the performance test are not in accordance with the above, service is required. Remove the HT-S tester from service and contact Compliance West USA, Inc. for servicing information.

Setting up the HT-S for Production Line Testing

This section describes procedures for setting the Leakage current level, Ground Continuity level, high voltage Ramp Time, high Voltage level, and high Voltage Test Time. The HT-S is calibrated as shown below at the factory to be usable without adjustment in the majority of applications. If the factory settings are acceptable, you may skip this section.

Factory Settings

The unit is configured as shown when shipped from Compliance West USA as it shown it in Table 6:

Table 6. Factory Settings.

HT-4200S, HT-3000S, HT-2000S	
Voltage Type:	AC
Leakage Current Level:	5 mA
High Voltage Ramp Time:	1 second
High Voltage Level:	1200 Volts
High Voltage Test Time:	2 seconds
Ground Continuity Level	1.50Ω
HT-2800S	
Voltage Type:	DC
Leakage Current Level:	2 mA
High Voltage Ramp Time:	1 second
High Voltage Level:	1700 Volts
High Voltage Test Time:	2 seconds
Ground resistance	1.50Ω

Adjustments of the various settings are shown below.

CAUTION

High voltage is generated by the HT-S. Although the chassis of the equipment under test is grounded by the HT-S, a risk of shock exists. Exercise care when using the HT-S.

NOTE

These adjustment procedures set the use parameters of the HT-S. They do not take the place of the annual calibration required by the safety agencies.

Display Setting Limits for Leakage, Time and Ground Continuity

To view the Test Duration, Leakage limit and Ground Continuity limit, hold down the **RESET** button for 2 seconds, then, the meter will display “L” with the Leakage Limit value in mA. Hold down the **RESET** button again for 2 seconds and the meter will display “d” with the Test Duration set time in seconds. Hold down the **RESET** button again and the meter will display “r” with the Ground Continuity limit in Ω . Hold down the **RESET** button again for 2 seconds to start over showing the Leakage Limit value, see Figure 5.



Figure 5. HT-S Test Settings

Adjustment of the High Voltage Level

This procedure controls the high voltage level used in the dielectric withstand test. It is specified by safety agency personnel. Most safety agencies will allow a shorter test (usually 1 sec. vs. 1 min.) if the voltage is increased by 20%. The HT-S is factory set for 1200 volts AC or 1700 DC, a voltage level used for the one second test for many types of equipment. Consult the safety agencies for the required voltage level for the type of equipment being tested. If a different voltage level is required, use this procedure to set it.

- Disconnect all leads of the HT-S front panel.
- Turn the **Ground Check** switch on the rear panel to the Off position.
- Set the Test Time to at least 30 seconds, use the procedure **of the High Voltage Test Time**.
- Connect the HT-S to a correctly rated source of supply and turn the power switch to the I or ON position. Push the **RESET** button. The yellow **TEST** indicator should light, indicating that the HT-S is ready to test.
- Use the AC/DC button to select the type of output voltage (Only HT-3000S and HT-4200S).
- After the **TEST** button is pressed, the voltage will ramp and hold. Using a driver set the **Voltage Adjust** control on the rear panel to the desired voltage.
- If tamperproof operation is desired, we suggest placing a calibration-style label over the voltage adjust hole.
- Check the position of the **Ground Check** Switch, and adjust the test time to the desired value using the procedure **of the High Voltage Test Time**.

Adjustment of the High Voltage Test Time

This procedure sets the length of time the HT-S will conduct the high voltage test. The test time is specified by the safety agencies and is tied to the test voltage. Most safety agencies will allow a much shorter test (usually 1 second vs 1 minute) if the voltage is increased by 20%. The HT-S is factory set for 2 seconds. Consult the safety agencies for the test time for the type of equipment being tested. If a different test time is required, use this procedure to set it.

Connect the HT-S to a correctly rated source of supply and turn the power switch to the I or ON position. Push the **RESET** button. The yellow **TEST** indicator should light, indicating that the HT-S is ready to test. On the rear panel turn the **Test Time** potentiometer, as soon as the potentiometer starts turning, the meter will display “d” and the value can be set in 1 second increments from 1 to 60 seconds.

Adjustment of the Leakage Current Level

To set the leakage limit follow the steps below:

1. Connect the HT-S to a correctly rated source of supply and turn the power switch to the I or ON position. Push the **RESET** button. The yellow **TEST** indicator should light, indicating that the HT-S is ready to test.
2. Use the AC/DC button to select the type of output voltage (Only HT-30000S and HT-4200S).
3. On the rear panel turn the **Leakage Limit** potentiometer, as soon as the potentiometer starts turning, the meter will start blinking, and it will show “L” with the new excess leakage limit set in the scale of mA with increments 0.1 mA.

Adjustment of High Voltage Ramp Time

1. This procedure controls the amount of time used to ramp the high voltage to the required level. The factory setting of two seconds is adequate for most situations. Use this procedure if adjustment to a different ramp time within the range of 1 to 5 seconds is required.
2. Turn the **Ground Check** switch on the rear panel to the Off position.
3. Connect the HT-S to a correctly rated source of supply and turn the power switch to the I or ON position. Push the **RESET** button. The yellow **TEST** indicator should light, indicating that the HT-S is ready to test.
4. Make sure there are no test leads connected to the HT-S. Push the **TEST** button.
5. When the **TEST** button is pressed, the voltage will ramp and hold. Adjust the **Ramp Time** control on the rear panel until the desired ramp time is reached. The test can be terminated at any time by pressing the **RESET** button.
6. Check the position of the **Ground Check** switch before testing.

Setting the Ground Check Switch

This switch controls whether the Ground Continuity Test is conducted between the chassis and the power supply cord grounding pin of the unit being tested. The safety agencies require that this test be conducted on all equipment using a three-wire power supply cord. For other types of equipment, such as some portable lamps and all double-insulated equipment, there are only two wires in the power supply cord and the ground continuity check is waived by the safety agencies.

If the power supply cord of the equipment being tested has only two pins, the **Ground Check** switch should be set to the Off position. When the **Ground Check** switch is turned Off, both the green **Ground OK** and red **Ground Open** LED's on the front panel are lit as a reminder to the operator that the ground continuity test is not being conducted.

If the power supply cord of the equipment being tested has three pins, the **Ground Check** switch should be set to the On position.

When testing with the **Ground Check** switch Off, the operator must ensure that the **Return** lead is properly connected to exposed dead metal of the equipment being tested for safety and to ensure that the HT-S properly reports all failures.

The small size of the **Ground Check** switch will allow a calibration-type adhesive label to be placed over it to allow for tamper-proof operation.

Adjustment of the Ground Continuity Limit

To set the ground continuity limit follow the steps below:

On the rear panel turn the **Ground Resistance** potentiometer, as soon as the potentiometer starts turning, the meter will start blinking, displaying the letter “r” with the new limit value in Ω .

Adjustment of Ground Continuity Offset

When the Ground Continuity test is activated, the offset function may be used to compensate for lead and test fixture resistance during the Ground Continuity test. To set the Ground Continuity offset follow the steps below:

1. Turn the **Ground Check** switch on the rear panel to the ON position.
2. Turn Off the HT-S unit.
3. Plug the supplied Ground Continuity Connector Tip into the bottom round slot of the orange receptacle located on the front panel.
4. Plug the supplied 18 AWG GL Test Lead (Alligator Clip/Banana Plug ends, black) into the **RETURN** receptacle on the front panel, then, connect in short-circuit the green alligator clip end to the Ground Connector Tip connected on step 3. See Figure 6.
5. For HT-4200S plug the supplied 18 AWG GL Test Lead (Alligator Clip/Banana Plug ends, black) into the **RETURN** receptacle on the front panel Plug the supplied 18 AWG GL Test Lead into the **GROUND CHECK** receptacle on the front panel, then, connect in short-circuit both of the the two green alligator clip end.
6. Turn On the HT-S unit.
7. Adjust the Ground Continuity Offset, by pressing and holding the **Ground Offset** button for 5 seconds on the rear panel, the new offset resistance reading should be shown on the front display for a few seconds. If the display shows “Cnct”, the new offset adjustment will be discarded.
8. To review the Ground Continuity Offset adjustment, by pressing and holding the **Ground Offset** Button on the rear panel for 1 second. The front display most shows “r0.00” \pm 0.02 Ω , otherwise review the test cables of fixture and start over on step 2.

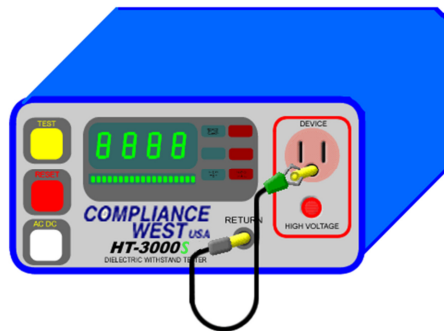

Figure 6. Short on the Ground Continuity Circuit

Ground Continuity Resistance Measurement

NOTE

It is recommended to perform the adjustment of the Ground Continuity Offset before measuring the Ground Continuity Resistance.

To measure the Ground Continuity Resistance follows the next steps:

- a. Turn Off the HT-S unit.
- b. Turn the **Ground Check** switch on the rear panel to the ON position.
- c. Connect the EUT fixture to the Return and Ground Continuity Measurement point of the HT-S unit.
- d. Turn On the HT-S unit.
- e. Press and hold for 1 second the **Ground Offset** button, located on the rear panel. The front display will show for a few seconds the Ground Continuity resistance of the EUT fixture connected on step 3.
- f. Only if the Ground Continuity resistance measurement is more than 1.50Ω , the display will show "OPEn".

Operation Techniques

The following paragraphs describe how to operate the HT-S tester. Before proceeding with testing, the HT-S tester should be set up for production line testing. See Section above before continuing.

CAUTION:

High voltage is generated by the HT-S. Although the chassis of the equipment under test is grounded by the HT-S, a risk of shock exists. Exercise care when using the HT-S.

Testing

This section describes how the HT-S tester is used to conduct a Hipot test. Before continuing, we recommend that you read Section 1, "An Introduction to Dielectric Withstand Testing with the HT-S". It contains valuable safety, operation, and test result evaluation information which can help you conduct the test safely and correctly. The test can be stopped immediately at any time by pressing the red **RESET** button on the front panel.

Testing a Device with 3-Wire Power Supply Cord

1. Connect the HT-S unit to a correctly rated source of supply and turn the power switch to the I or ON position. Push the **RESET** button. The yellow **TEST** indicator should light, indicating that the HT-S unit is ready to test.
2. Turn the **Ground Check** switch on the rear panel to the On position.
3. Plug the 18 AWG GL Test Lead (Alligator Clip/Banana Plug ends, black) into the **RETURN** receptacle on the front panel of the HT-S unit, then, connect the alligator clip end to an exposed metal part on the chassis of the equipment to be tested.
4. Plug the power supply cord of the device being tested into the **Device** receptacle on the front panel of the HT-S unit. See Figure 7 for detailed connections.

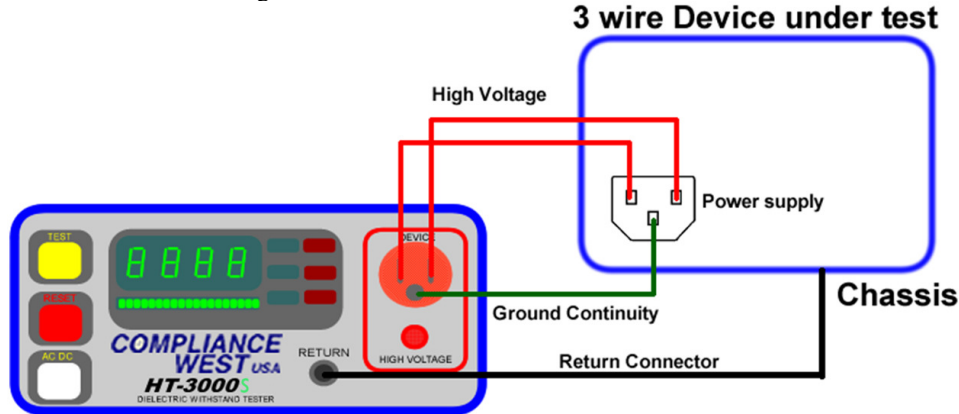

Figure 7. Testing a Three Wire Power Cord Device.

5. Make sure the power switch on the device being tested is in the 1 or ON position. Push the **TEST** button on the HT-S unit. The HT-S unit will:
 - 5.1 Check for ground continuity between exposed metal parts and the grounding pin of the power supply cord.
 - If the ground circuit resistance is higher than the limit set on the HT-S unit, the red **Ground Open** LED will light, the buzzer will sound, and the test will terminate.
 - If the ground circuit resistance is less than the limit set on the HT-S unit, the green **Ground OK** LED will light and the test will continue.
 - 5.2 Ramp the voltage at the rate set by the Ramp Time procedure.
 - If leakage current between the AC pins of the power supply cord and the chassis ground of the unit rises above the value set by the Leakage Limit procedure, the red **Excess Leakage** LED will light, the buzzer will sound, and the test will terminate.
 - If the leakage current level is below the set level when the high voltage set by the High Voltage Level procedure is reached, the green **Full Voltage** LED will light and the test will continue.
 - 5.3 Conduct the high voltage test for the amount of time set in the Test Duration procedure.
 - If a breakdown of the insulation system between primary voltage and ground is detected, the red **Hipot Fail** LED will light, the buzzer will sound, and the test will terminate.
 - If no breakdown is detected, the high voltage will be bled off, the green **Hipot Pass** LED will light, and the red **RESET** switch will light.
6. For safety, the operator should not disconnect the cords until the **Hipot Pass** LED is lit and the reading on the front panel voltage meter has dropped to zero. This will ensure that the test voltage has been bled off.
7. The operator can now remove the equipment from the HT-S unit and connect another. The HT-S unit should then be armed by pressing the **RESET** button. When ready, the operator then presses the **TEST** button and the test procedure will be conducted again.

Testing a Device with 2-Wire Power Supply Cord

1. Connect the HT-S unit to a correctly rated source of supply and turn the power switch to the I or ON position. Push the **RESET** button. The yellow **TEST** indicator should light, indicating that the HT-S unit is ready to test.
2. Turn the **Ground Check** switch on the rear panel to the Off position.
3. Plug the 18 AWG GL Test Lead (Alligator Clip/Banana Plug ends, black) into the **RETURN** receptacle on the front panel of the HT-S unit, then, connect the alligator clip end to an exposed metal part on the chassis of the equipment to be tested.
4. Plug the power supply cord of the device being tested into the **Device** receptacle on the front panel of the HT-S unit. See Figure 8 for detailed connections.

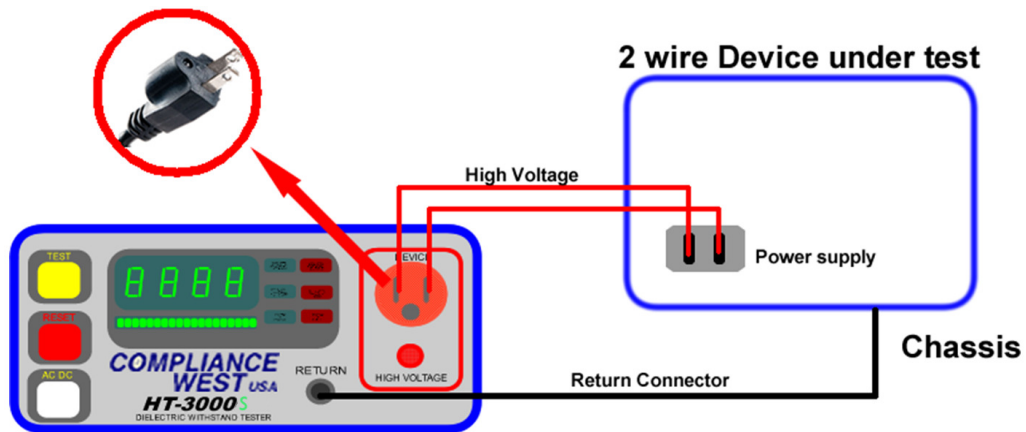

Figure 8. Testing a Two Wire Power Cord Device

5. Make sure the power switch on the device being tested is in the 1 or ON position. Push the **TEST** button on the HT-S unit. The HT-S unit will:
 - 5.1 Ramp the voltage at the rate set by the Ramp Time procedure.
 - If leakage current between the AC pins of the power supply cord and the chassis ground of the unit rises above the value set by the Leakage Limit procedure, the red **Excess Leakage** LED will light, the buzzer will sound, and the test will terminate.
 - If the leakage current level is below the set level when the high voltage set by the High Voltage Level procedure is reached, the green **Full Voltage** LED will light and the test will continue.
 - 5.2 Conduct the high voltage test for the amount of time set in the Test Duration procedure.
 - If a breakdown of the insulation system between primary voltage and ground is detected, the red **Hipot Fail** LED will light, the buzzer will sound, and the test will terminate.
 - If no breakdown is detected, the high voltage will be bled off, the green **Hipot Pass** LED will light, and the red **RESET** switch will light.
6. For safety, the operator should not disconnect the cords until the **Hipot Pass** LED is lit and the reading on the front panel voltage meter has dropped to zero. This will ensure that the test voltage has been bled off.
7. The operator can now remove the equipment from the HT-S unit and connect another. The HT-S unit should then be armed by pressing the **RESET** button. When ready, the operator then presses the **TEST** button and the test procedure will be conducted again.

Section 4

Technical Assistance

Contact Information

Technical Assistance from Compliance West USA is available:

Phone: (800) 748-6224

Hours: 8:30 AM - 4:30 PM Pacific Time.

Also available on our web site at: www.compwest.com

Contact:

Compliance West USA
650 Gateway Center Way Suite D
San Diego, CA 92102
United States of America.

Phone: (619) 878-9696

FAX: (619) 794-0404

Section 5

Maintenance and Calibration

WARNING:

THESE SERVICE INSTRUCTIONS ARE FOR USE BY QUALIFIED PERSONNEL ONLY. TO AVOID ELECTRIC SHOCK, DO NOT PERFORM ANY SERVICING OTHER THAN THAT CONTAINED IN THE OPERATING INSTRUCTIONS UNLESS YOU ARE QUALIFIED TO DO SO.

Service Information

The CDT-240 Tester is warranted to the original purchaser for a period of 1 year. This warranty does not cover problems due to misuse or neglect.

Malfunctions which occur within the limits of the warranty will be corrected at no charge. Mail the instrument post paid to the manufacturer. Dated proof of purchase is required for all in-warranty repairs.

The manufacturer is also available for calibration and/or repair of instruments that are beyond their warranty period. Contact the manufacturer for a cost quotation. Ship the instrument and your remittance according to the instructions given by the manufacturer.

Cleaning

CAUTION

Do not use aromatic hydrocarbons or chlorinated solvents for cleaning. These solutions will react with the plastic materials used in the instrument.

Clean the front panel and case with a mild solution of detergent and a damp sponge. Clean dust from the PWB with clean, dry, low pressure (<20 psi).

Calibration Information

The HT-S series tester has been fully calibrated at the factory in accordance to our published specifications. It is recommended that you have this instrument re-calibrated and safety check done at least once per year.

Contact Compliance West USA for the latest calibration procedure and have ready the serial number of the tester.



Call Us 1.877.571.7901