

# FieldFox Handheld Analyzers

4/6.5/9/14/18/26.5/32/44/50/54 GHz

## Introduction

This configuration guide describes configurations, options, and accessories for the FieldFox B-Series family of portable analyzers. Use this guide, along with the technical overview and data sheet, for a complete description of the analyzers. The table on page 3 titled “FieldFox B-Series Family and Options” shows a comparison of the functions available in the FieldFox B-Series family of analyzers.

Note: Combination analyzer (combo) = Cable and antenna tester (CAT) + Vector network analyzer (VNA) + Signal analyzer (SA).

### Included accessories

The following accessories are included with every FieldFox:

- AC/DC adapter
- Battery
- Soft carrying case
- LAN cable



## Table of Contents

FieldFox B-Series Family and Options .....	3
FieldFox RF and Microwave (Combination) Analyzers.....	4
FieldFox RF and Microwave (Combination) Analyzer FAQs .....	6
ERTA System Typical Configuration.....	9
FAQs – Applicable to All FieldFox RF and Microwave Analyzers .....	10
FieldFox RF and Microwave Signal Analyzers .....	11
FieldFox Signal Analyzer FAQs .....	13
Upgrades.....	13
Documentation .....	16
Calibration Kits .....	16
Accessories.....	18

# FieldFox B-Series Family and Options

Option	Description	Combination Analyzers	Signal Analyzers
		N9913/4/5/6/7/8B N9950/1/2/3B	N9933/4/5/6/7/8B N9960/1/2/3B
<b>CAT / vector network analysis</b>			
010	VNA time domain	✓	—
210	VNA transmission/reflection	✓	—
211	VNA full 2-port S-parameters	✓	—
212	1-port mixed-mode S-parameters	✓	—
215	TDR cable measurements	✓	—
305	Cable and antenna analyzer	Base model <sup>1</sup>	— <sup>2</sup>
308	Vector voltmeter	✓	—
320	Reflection meas. (RL, VSWR and scalar meas.)	— <sup>3</sup>	✓
<b>Spectrum analysis</b>			
209	Extended range transmission analysis (ERTA)	✓	✓
220	Tracking generator	— <sup>4</sup>	✓
233	Spectrum analyzer	✓	Base model <sup>1</sup>
235	Pre-amplifier	✓	✓
236	Interference analyzer and spectrogram	✓	✓
238	Spectrum analyzer time gating	✓	✓
312	Channel scanner	✓	✓
350	Real-time spectrum analyzer (RTSA)	✓	✓
351	I/Q analyzer (IQA)	✓	✓
352	Indoor and outdoor mapping	✓	✓
353	IQ streaming	✓	✓
355	Analog demodulation	✓	✓
356	Noise figure (NF)	✓	✓
358	EMF measurements	✓	✓
360	Phased array antenna support	✓	✓
361	EMI measurements	✓	✓
370	Over-the-air (OTA) LTE FDD	✓	✓
371	Over-the-air (OTA) LTE TDD	✓	✓
377	Over-the-air (OTA) 5G TF	✓	✓
378	Over-the-air (OTA) 5G NR	✓	✓
B04	Analysis bandwidth, 40 MHz <sup>5</sup>	✓	✓
B10	Analysis bandwidth, 120 MHz <sup>5</sup>	✓	✓
<b>Power measurements</b>			
208	USB power sensor meas. versus frequency	✓	✓
302	USB power sensor support	✓	✓
310	Built-in power meter	✓	✓
330	Pulse meas. with USB peak power sensor	✓	✓
<b>System features</b>			
030	Remote control capability	✓	✓
307	GPS receiver	✓	✓
309	DC bias variable-voltage source	✓	✓
—	Frequency extender support <sup>6</sup>	✓	✓
<b>Windows based software</b>			
89601B	PathWave VSA (89600 VSA) software	✓	✓
N6820ES	Surveyor 4D software	✓	✓

1. Base model functionality listed is the primary function of that instrument. For example, on the N991x/5xB combo analyzers, cable and antenna analyzer is the standard function included with every N991x/5xB.
2. Option 305 is not available on the N993x/6xB. A subset of measurements, return loss and VSWR, is available as Option 320.
3. Option 320 is not applicable to N991x/5xB. The N991x/5xB includes reflection measurements of return loss and VSWR as standard functions.
4. On the N991x/5xB analyzers, order Options 233 and 210 to obtain a tracking generator with the spectrum analyzer. There is no Option 220 on the N991x/5xB analyzers. Option 233 provides the spectrum analyzer capability and Option 210 the "tracking" capability.
5. 10 MHz standard.
6. Models N9913/33B, N9914/34B and N9915/35B do not support frequency extenders. This is because the mixers' starting LO frequency is higher than 9 GHz and the FieldFox Port 1 provides the LO to the mixer. For a list of supported OML frequency extenders, see Accessories pages 19-20.

# FieldFox RF and Microwave (Combination) Analyzers

## Analyzer models

**Step 1. Select the model that provides the desired frequency range.**

Model	Description	CAT and VNA frequency	SA frequency <sup>1</sup>	Test port connectors
N9913B	4 GHz FieldFox RF analyzer	30 kHz to 4 GHz	9 kHz to 4 GHz	Type-N (f)
N9914B	6.5 GHz FieldFox RF analyzer	30 kHz to 6.5 GHz	9 kHz to 6.5 GHz	Type-N (f)
N9915B	9 GHz FieldFox microwave analyzer	30 kHz to 9 GHz	9 kHz to 9 GHz	Type-N (f)
N9916B	14 GHz FieldFox microwave analyzer	30 kHz to 14 GHz	9 kHz to 14 GHz	Type-N (f)
N9917B	18 GHz FieldFox microwave analyzer	30 kHz to 18 GHz	9 kHz to 18 GHz	Type-N (f)
N9918B	26.5 GHz FieldFox microwave analyzer	30 kHz to 26.5 GHz	9 kHz to 26.5 GHz	3.5 mm (m)
N9950B	32 GHz FieldFox microwave analyzer	300 kHz to 32 GHz	9 kHz to 32 GHz	2.4 mm (m)
N9951B	44 GHz FieldFox microwave analyzer	300 kHz to 44 GHz	9 kHz to 44 GHz	2.4 mm (m)
N9952B	50 GHz FieldFox microwave analyzer	300 kHz to 50 GHz	9 kHz to 50 GHz	2.4 mm (m)
N9953B	54 GHz FieldFox microwave analyzer	300 kHz to 54 GHz	9 kHz to 54 GHz	1.8 mm (m)

1. Useable to 5 kHz.

## Analyzer Options

**Step 2. Select optional measurement capabilities.**

Any of these options can easily be added as a software upgrade in the future.

Option	Description	Prerequisite options/notes
<b>CAT/vector network analysis</b>		
010	VNA time domain	Requires 210, recommend 211. See FAQ #7
210	VNA transmission/reflection	Recommend ordering a calibration kit. See FAQ #4 and FAQ #6
211	VNA full 2-port S-parameters	Requires 210, recommend ordering a calibration kit. See FAQ #5
212	1-port mixed-mode S-parameters	Requires 210 and 211
215	TDR cable measurements	—
308	Vector voltmeter	210 and 211 required for full VVM functionality. See FAQ #8
<b>Spectrum analysis</b>		
209	Extended range transmission analysis (ERTA)	Requires 233 and 210. Recommend 307. Requires two FieldFox units. See FAQ #9. See page 9 for typical configuration.
233	Spectrum analyzer	—
235	Pre-amplifier	Requires 233
236	Interference analyzer and spectrogram	Requires 233
238	Spectrum analyzer time gating	Requires 233
312	Channel scanner	Requires 233. Require the corresponding option to support a specific app. For example, to support EMF in channel scanner requires 358.
350	Real-time spectrum analyzer (RTSA)	Requires 233, Recommend 235. See FAQ #11
351	I/Q Analyzer (IQA)	Requires 233
352	Indoor and outdoor mapping	Requires 233, 307, and at least one of 312, 360, 370, 371, 377 or 378. See FAQ #15
353	IQ streaming	Requires 233 and 351
355	Analog demodulation	Requires 233

Option	Description	Prerequisite options/notes
356	Noise Figure (NF)	Requires 233, 235, 309 and accessory item N9910X-713 BNC to SMB cable. See FAQ #13 for external preamplifier and noise source requirements.
358	EMF measurements	Requires 233. Also requires triaxial antenna. See FAQ #16
360	Phased array antenna support	Requires 233. Also requires phased array antenna. N991x/3xB (x > 5) models require external mixer. No external mixer required for N995x/6xB models. See FAQ #14
361	EMI measurements	Requires 233
370	Over-the-air (OTA) LTE FDD	Requires 233 and 307. Recommend 235.
371	Over-the-air (OTA) LTE TDD	Requires 233 and 307. Recommend 235.
377	Over-the-air (OTA) 5G TF	Requires 233 and 307. Recommend 235. N991x/3xB (x > 5) models require external mixer. See FAQ #14 No external mixer required for N995x/6xB models. 5G TF is pre-5G standard
378	Over-the-air (OTA) 5G NR	Requires 233, B10, and 307. Recommend 235. N991x/3xB (x > 5) models require external mixer for FR2 frequencies above 26.5 GHz. See FAQ #18. No external mixer required for N995x/6xB models.
B04	Analysis bandwidth, 40 MHz <sup>1</sup>	Requires 233. Recommend 350, 351 or PathWave VSA (formerly 89600 VSA) software
B10	Analysis bandwidth, 120 MHz <sup>1</sup>	Requires 233. Recommend 350, 351, 378 or PathWave VSA (formerly 89600 VSA) software.
<b>Power measurements</b>		
208	USB power sensor meas. versus frequency	Requires 302 See FAQ I
302	USB power sensor support	Need to order USB power sensor <sup>2</sup> See FAQ A
310	Built-in power meter	No power sensor required. See FAQ B
330	Pulse meas. with USB peak power sensor	Requires 302 and USB peak power sensor. See FAQ G and FAQ H
<b>System features</b>		
030	Remote control capability	Requires an iOS or an Android device
307	GPS receiver	Need to order GPS antenna, N9910X-825. See FAQ C
309	DC bias variable-voltage source	Recommend N9910X-713 cable. See FAQ D
—	Frequency extender support	Requires 233. Optional 350, 351, 360, 370, 371, 377, 378, PathWave VSA (formerly 89600 VSA) software. See Accessories, pages 19-20
<b>Windows based software</b>		
89601B	PathWave VSA (89600 VSA) software	Requires 233
N6820ES	Surveyor 4D software	Requires 233, 235 and 307. See FAQ #17

1 10 MHz standard.

2. List of compatible sensors available from [www.keysight.com/find/fieldfoxsupport](http://www.keysight.com/find/fieldfoxsupport).

# FieldFox RF and Microwave (Combination) Analyzer FAQs

Question	Answer
1. What is included with a base N991x/5xB analyzer?	<p>The base model includes the cable and antenna analyzer</p> <p>Measurements: DTF (dB, linear, VSWR), return loss and DTF, return loss (dB), and 1-port cable loss</p> <p>Calibrations: CalReady, OSL, and response calibration</p> <p>Note: 2-port insertion loss is NOT included with the base model, if 2-port insertion loss is needed, order Option 210</p> <p>Note: Base analyzer does not have phase information, for S11 or S21 phase, order Option 210</p>
2. What is included with N991x/5xB Option 233?	<p>Basic spectrum analysis, four traces, different detector types, radio standard selection, limit lines</p> <p>Channel power, occupied bandwidth, adjacent channel power, spectrum emission mask</p> <p>AM/FM tune and listen, field strength measurements, antenna factors, frequency counter marker</p> <p>Tracking generator (TG)/Independent source:</p> <ul style="list-style-type: none"> <li>TG CW mode (source CW frequency can be set independent of SA frequency) - included</li> <li>TG CW coupled mode (source CW frequency is auto coupled to SA's center frequency) - included</li> <li>TG tracking mode (traditional TG operation, swept SA coupled to swept source) - (requires Option 210)</li> </ul>
3. What is included with N991x/5xB Option 236?	Interference analyzer and spectrogram, trace playback and recording
4. What is included with N991x/5xB Option 210?	<p>Option 210 adds a VNA with transmission/reflection (T/R) capability</p> <p>Measurements: S21, S11, magnitude and phase</p> <p>Additionally, in the CAT mode, you can measure 2-port insertion loss</p> <p>Calibrations: CalReady, OSL, response, and enhanced response cal</p> <p>If you need all four S-parameters, order Options 210 and 211</p> <p>If you need 2-port cal, order Options 210 and 211</p> <p>Adds tracking mode to the tracking generator/independent source included with Option 233, spectrum analyzer</p>
5. What is included with N991x/5xB Option 211?	<p>Option 211 adds full 2-port S-parameter capability to the VNA mode</p> <p>Measurements: All four S-parameters (S11, S21, S22, S12), magnitude and phase</p> <p>Calibrations: CalReady, OSL, response, enhanced response, and full 2-port calibration</p>
6. Can I measure group delay on N991x/5xB analyzers?	<p>If you have phase measurement capability, then you can measure group delay. Option 210 is required for any phase measurement capability. So, if you do not have Option 210, you cannot measure group delay.</p> <p>S11/S21 in time domain, if Option 210 is ordered. To get time domain data for all four S-parameters and full 2-port cal, order Option 211.</p>
7. What is included with N991x/5xB Option 010?	<p>View both time and frequency domain data at the same time</p> <p>Low-pass, impulse, and band-pass modes</p> <p>Minimum, medium, and maximum window</p> <p>Gating</p> <p>With Option 308: 1-port cable trimming</p>
8. What is included with N991x/5xB Option 308?	<p>With Options 308 and 210: 1-port cable trimming, 2-port transmission</p> <p>With Options 308, 210, and 211: 1-port cable trimming, 2-port transmission, A/B and B/A</p> <p>Note: A/B and B/A measurements require an external source</p> <p>Extended Range Transmission Analysis (ERTA) or Option 209 is a scalar measurement system based on the use of two (2) FieldFox units. One FieldFox acts as the source and reference receiver, while the second FieldFox acts as the measurement receiver. When different frequency models are used in an ERTA pair, the system frequency range is limited to the lowest of the pair.</p> <p><b>Required hardware</b></p> <p>A. Two (2) FieldFox units. FieldFox units can be any of these models:</p> <ul style="list-style-type: none"> <li>FieldFox combination analyzers: N9913/14/15/16/17/18/50/51/52/53B</li> <li>FieldFox signal analyzers: N9933/34/35/36/37/38/60/61/62/63B</li> </ul> <p>The two FieldFox units used in ERTA do not have to be the same model.</p> <p>ERTA requires the following options on Combo FieldFox models (N9913/14/15/16/17/18/50/51/52/53B):</p> <ul style="list-style-type: none"> <li>Option 210, VNA transmission/reflection</li> <li>Option 233, spectrum analyzer</li> </ul> <p>ERTA requires the following options on SA FieldFox models (N9933/34/35/36/37/38/60/61/62/63B)</p> <ul style="list-style-type: none"> <li>Option 220, tracking generator</li> </ul> <p>Both FieldFox units (the one used as the source, and the other used as the receiver) must have the options listed above. The ERTA option (209) cannot be installed unless 210 and 233 are present on a combo analyzer; or 220 is present on a SA analyzer.</p> <p>With either the Combo or SA FieldFox units, the following options are highly recommended:</p>
9. What are the requirements for Option 209?	<p>The two FieldFox units used in ERTA do not have to be the same model.</p> <p>ERTA requires the following options on Combo FieldFox models (N9913/14/15/16/17/18/50/51/52/53B):</p> <ul style="list-style-type: none"> <li>Option 210, VNA transmission/reflection</li> <li>Option 233, spectrum analyzer</li> </ul> <p>ERTA requires the following options on SA FieldFox models (N9933/34/35/36/37/38/60/61/62/63B)</p> <ul style="list-style-type: none"> <li>Option 220, tracking generator</li> </ul> <p>Both FieldFox units (the one used as the source, and the other used as the receiver) must have the options listed above. The ERTA option (209) cannot be installed unless 210 and 233 are present on a combo analyzer; or 220 is present on a SA analyzer.</p> <p>With either the Combo or SA FieldFox units, the following options are highly recommended:</p>

Question	Answer												
	<ul style="list-style-type: none"> <li>Option 235, preamplifier – this option increases the measurement dynamic range by increasing the received signal power</li> <li>Option 307, GPS receiver – this option increases the dynamic range by increasing the frequency accuracy and permitting the use of a narrower RBW</li> </ul> <p>B. Power splitter, two-resistor model, Keysight 11667A, 11667B, or 11667C. Other power splitters can be used but the specifications listed are based on the match and tracking performance of 11667A, 11667B, or 11667C. Three-resistor power splitters are not recommended.</p> <p>C. N9910X-712, Trigger/Reference-in cable, SMA (m) to BNC(f), 1 m, quantity two</p> <p>D. N9910X-713, Trigger/Reference-out cable, SMB (m) to BNC (m), 1 m, quantity two</p> <p>E. LAN connection – For ERTA, the two FieldFox units communicate via a LAN connection. For a direct connection, a cross-over LAN cable is required. Alternately, both analyzers can be on a local area network.</p> <p><b>Recommended accessory</b></p> <p>F. N9910X-825, GPS Antenna. Necessary if Option 307 is ordered.</p>												
10. What is included with Option 355?	FieldFox analog demodulation has two parts: (1) Tune and listen, and (2) AM/FM metrics. Tune and listen is available with the purchase of the spectrum analyzer option 233. AM/FM metrics becomes available when Option 355 is purchased. AM/FM metrics provides the user with RF spectrum view, demodulated baseband signal waveform, carrier power, frequency deviation, SINAD and more.												
11. What is included with Option 350?	Real-time spectrum analyzer (RTSA) or Option 350 provides real-time measurements on a FieldFox. The FieldFox must be equipped with spectrum analysis capability. The preamplifier option is recommended, as elusive signals often have low power levels. The maximum real-time bandwidth for option 350 is 10 MHz. RTSA includes trace recording and playback capabilities. It does not include a frequency-mask trigger (FMT).												
12. Is Spectrum Analyzer Trace Recording and Playback standard or an option?	<p>Spectrum Analyzer mode (Option 233) does not include Trace Recording and Playback by default. To obtain this capability in SA mode, Option 236 Interference Analyzer and Spectrogram needs to be purchased.</p> <p>RTSA mode (Option 350) does include Trace Recording and Playback by default in RTSA mode.</p> <p>Purchasing RTSA mode (Option 350) does not enable Trace Recording and Playback in SA mode (Option 233).</p> <table border="1"> <thead> <tr> <th>Trace record/playback features</th> <th>SA mode SA and Interference Analyzer Options 233 and 236</th> <th>RTSA mode RTSA Option 350</th> </tr> </thead> <tbody> <tr> <td>Record and playback spectrum traces</td> <td>Yes</td> <td>Yes</td> </tr> <tr> <td>Save trace data with GPS time stamp over time</td> <td>Yes</td> <td>Yes</td> </tr> <tr> <td>Record and playback spectrogram data</td> <td>Yes</td> <td>No <sup>1</sup></td> </tr> </tbody> </table>	Trace record/playback features	SA mode SA and Interference Analyzer Options 233 and 236	RTSA mode RTSA Option 350	Record and playback spectrum traces	Yes	Yes	Save trace data with GPS time stamp over time	Yes	Yes	Record and playback spectrogram data	Yes	No <sup>1</sup>
Trace record/playback features	SA mode SA and Interference Analyzer Options 233 and 236	RTSA mode RTSA Option 350											
Record and playback spectrum traces	Yes	Yes											
Save trace data with GPS time stamp over time	Yes	Yes											
Record and playback spectrogram data	Yes	No <sup>1</sup>											
13. What are the requirements for Noise figure (NF) Option 356?	Requires spectrum analyzer mode (Option 233 on combination models), internal preamplifier (Option 235) and DC bias variable voltage source (Option 309) as well as CPU2 processor. An external noise source is also required and FieldFox supports Keysight noise source models 346A/B/C/K40/K01. Also recommended to improve accuracy is an external preamplifier Keysight models U7227A/C/F or U7228A/C/F. Requires accessory item N9910X-713 BNC to SMB cable for DC bias variable voltage source to noise source connection.												
14. What is required for phased array antenna support (Option 360) and 5G NR over-the-air (OTA) measurements (Option 378)?	Requires spectrum analyzer mode (Option 233 on combination models) and GPS receiver (Option 307). Highly recommend internal preamplifier (Option 235). N991x/3xB (x>5) models require external mixer since phased array antenna, which can be ordered as Keysight 85571A-028 or directly from Anokiwave as AWMF-0129, operates at 28 GHz. See FAQ #18 for more OML mixer information. No external mixer required for N995x/6xB models.												
15. What is included with indoor and outdoor mapping (Option 352)?	The FieldFox mapping function is available in the following modes: Channel Scanner (312), Phased-Array Antenna (360), and OTA LTE FDD/TDD (370/371), OTA 5G TF (377), OTA 5G NR (378). Mapping is currently not available in SA or RTSA modes. Outdoor mapping requires the availability of GPS (Option 307). Maps can be saved to the FieldFox internal memory, SD card or USB drive. Using a direct wired LAN connection, FieldFox will automatically access OpenStreetMap (OSM) once location coordinates (latitude and longitude) and zoom levels have been entered the Map Explorer menu. If using the I FieldFox Map Support Tool, OSM map files can be downloaded to a .zip file and imported to FieldFox internal memory. If the FieldFox GPS receiver is enabled and OSM maps have been previously saved to FieldFox with those GPS coordinates, FieldFox can automatically load the corresponding map to match the current GPS coordinates.												
16. What is required for EMF measurements (Option 358)?	Requires triaxial antenna. Supported antenna is AGOS advanced technologies Triaxial Isotropic Antenna model SDIA-6000 30 MHz to 6 GHz. It can also be ordered as Keysight 85572A-006. EMF measurements are supported with spectrum analyzer mode (Option 233 on combination models) and OTA 5G NR (Option 378).												
17. What is required for N6820ES Surveyor 4D software?	Surveyor 4D software connected to FieldFox spectrum analyzer mode offers a versatile, truly portable spectrum monitoring system that covers VLF to 50 GHz, including 5G millimeter wave bands. The software runs on an external PC or tablet. FieldFox required options include spectrum analyzer mode (Option 233 on combination models), preamplifier (Option 235) and built-in GPS receiver (Option 307). Core Surveyor 4D software for Windows (Option N6820ES-114) is required to run the Surveyor 4D software. Other Surveyor 4D software optional licenses that are supported include basic modulation recognition application (N6820ES-MR1) and universal signal detection (N6820ES-USD). Requires Surveyor 4D software version 4.3 or later (May 2019). Frequencies above 26.5 GHz will require external mixer for N991x/3xB (x>5) models. For external mixer information, FAQ #18. N995x/6xB models eliminate the external mixer requirement.												

**Question**

**Answer**

18. What is required for 5G NR over-the-air (OTA) measurements (Option 378)?

Requires spectrum analyzer mode (Option 233 on combination models), 120 MHz analysis bandwidth (Option B10) and GPS receiver (Option 307). Highly recommend internal preamplifier (Option 235). FR2 frequencies above 26.5 GHz will require external mixer for N991x/3xB (x>5) models. N995x/6xB models eliminate the external mixer requirements. For Keysight direct sales, mixer is orderable as Keysight model N9910XM28-H2A for 3.5 mm test ports or N99010xM28-H2N for type N test ports. For indirect sales, the mixer is orderable as OML Inc. model M28H2ADC-K, please see website [www.omlinc.com](http://www.omlinc.com) for more information or contact a Keysight representative. OML mixer RF input interface is 2.92 mm (f). See Pages 19-20 "Accessories" section for other supported OML mixers and OML frequency extender module adapter kits.

**Keysight model: N9910XM28-H2A/N9910XM28-H2N or OML model: M28H2ADC-K**

Supported on FieldFox models	N9916B, N9917B, N9918B, N9936B, N9937B, N9938B	
RF input frequency range	24 to 40 GHz	
IF output frequency range	0.3 to 6.5 GHz	
LO harmonic number	2	
LO input frequency range	12 to 20 GHz	
LO input power	-18 to -5 dBm	
Conversion factor IF = 1 GHz	10 dB (typical)	
Noise figure	12 dB	(Includes internal IF amplifier)

1. RTSA trace recordings can be recalled and played back in SA mode Spectrogram. This has the added benefit that the measurements are shown 'slower', making it easier for the human eye to decipher the signal content.

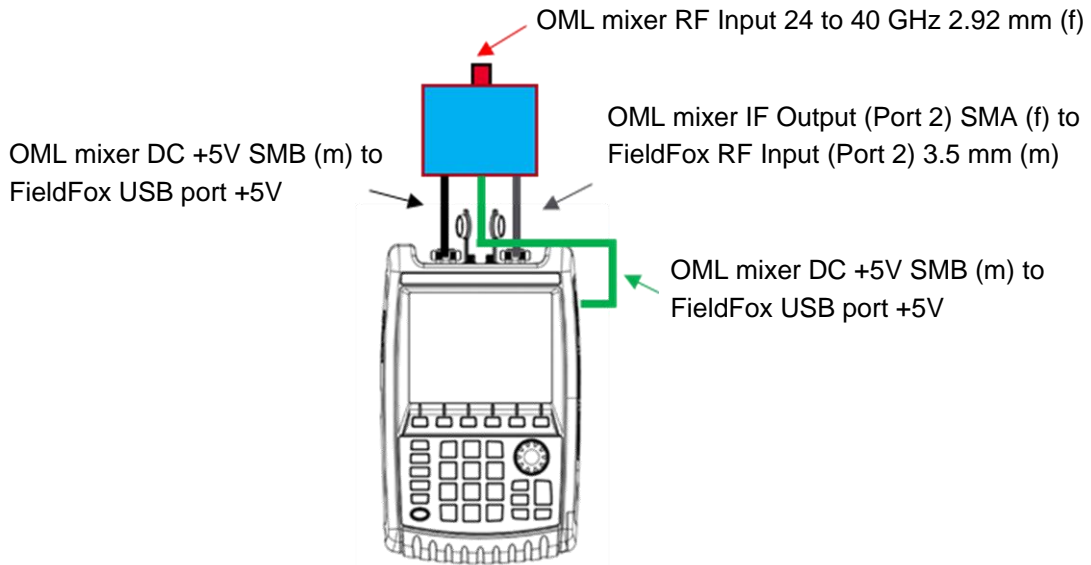

**Figure 1.** OML external mixer diagram <sup>1</sup>

<sup>1</sup> This diagram is for OML M28H2ADC-K or Keysight N9910XM28-H2A. In case of Keysight N9910XM28-H2N, the mixer connectors for LO Input and IF Output are both Type-N. See "OML frequency extender modules" and "OML frequency extender module adapter kits" sections on pages 19-20 for further details.



# ERTA System Typical Configuration

Item	Description/Options	Quantity
FieldFox	Combo analyzer: Required Options 210, 233. Recommended: 235, 307 SA analyzer: Required: Option 220. Recommended: 235, 307	2
Power splitter	11667A (Type-N) or 11667B (3.5 mm) or 11667C (2.4 mm)	1
Type-N(m) to Type-N(m) adapter	N9910X-850 (for use with 11667A or Type-N systems)	1
Trigger cables <sup>1</sup>	N9910X-712, SMA(m) to BNC(f) N9910X-713, SMB(m) to BNC(m)	2 of each Total of 4 cables
RF test cable	Connecting FieldFox source port 1 to power splitter input	1
RF test cable or adapter	Connecting power splitter output arm to FieldFox port 2	1
RF jumper cable or adapter	Power splitter output arm to DUT input	1
RF jumper cable or adapter	DUT output to FieldFox receiver port 2	1
LAN cable	LAN cable to connect two FieldFox units directly, or the analyzers must be on the LAN	1
N9910X-825	GPS antenna, recommended. Necessary if Option 307 is ordered.	2

1. The trigger cables and LAN cables must be at least as long as the separation distance between the two ends of the DUT.

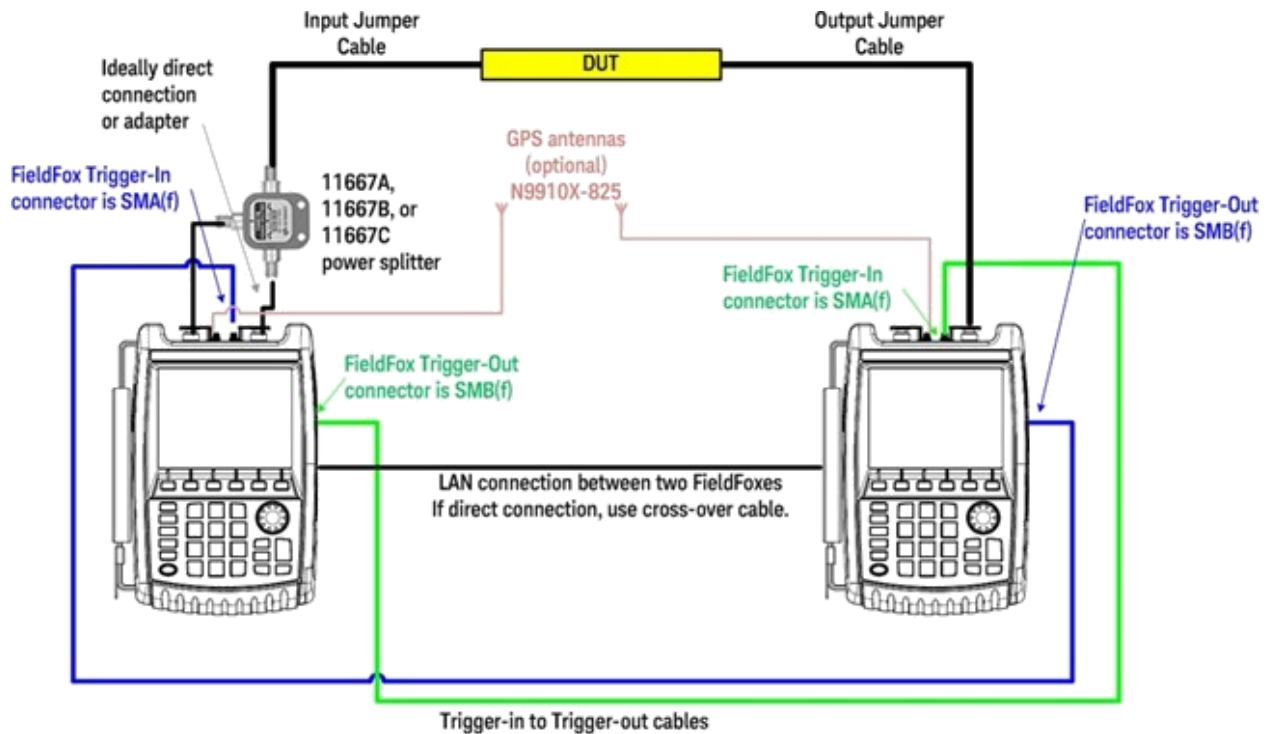
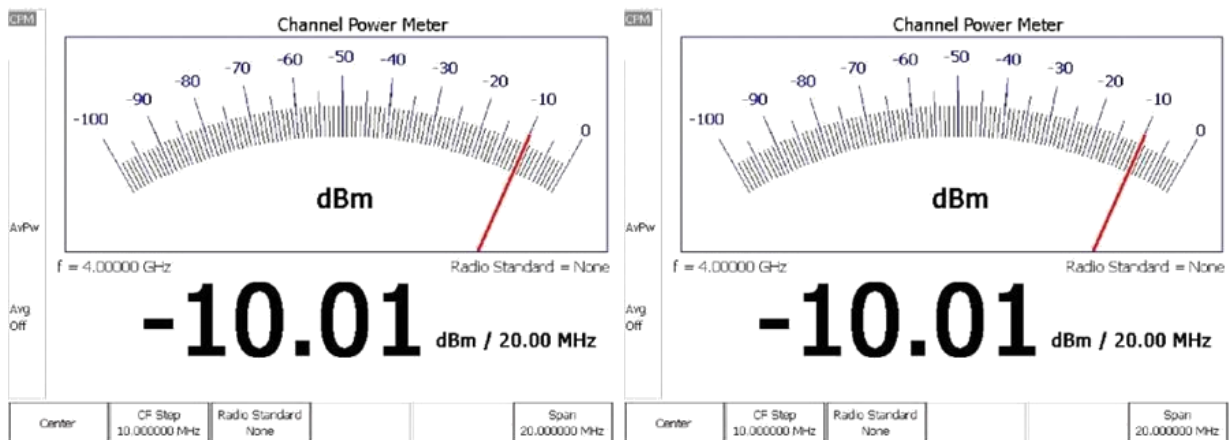

Figure 2. ERTA system diagram

# FAQs – Applicable to All FieldFox RF and Microwave Analyzers

Question	Answer		
A. What USB power sensors work with Option 302?	All Keysight U2000x Series USB power sensors are supported with FieldFox. Visit: <a href="http://www.keysight.com/find/fieldfoxsupport">www.keysight.com/find/fieldfoxsupport</a> for an up-to-date listing.		
B. What is the difference between USB power sensor (Option 302) and built-in power meter (Option 310)?	Option 302 USB power sensor	Option 310 Built-in power meter (or channel power meter)	
	Description	Option 302 allows users to connect a USB power sensor to FieldFox's USB port and make broadband power measurements	Option 310 is a channelized power measurement capability built into FieldFox analyzers. Maximum bandwidth is 100 MHz.
	External hardware	USB power sensor required	None. Uses internal receiver.
	Power measurement	Broadband diode detector measures all frequencies	Tuned receiver, so measures frequencies within defined channel bandwidth
	Frequency range	Depends on USB sensor	Frequency range of the analyzer
	Settings	Set CW frequency	Set CW frequency, set channel width/span
	Power range	Depends on USB sensor	Depends on channel width and attenuator setting
	Warm-up time	30 minutes to meet accuracy specifications	No warm-up time required
	Accuracy	Depends on USB sensor	InstAlign accuracy: $\pm 0.5$ dB typical for a CW signal. Since the measurement is within a certain frequency channel or bandwidth, to make an accurate measurement, the user needs to know the exact center frequency and the signal's bandwidth and set those accurately.
	Programmable	Yes, via SCPI	Yes, via SCPI
Physical connection	The power sensor can easily be moved to the measurement point, with a USB cable connecting the detector to FieldFox.	The measurement point needs to be connected to FieldFox's RF input port. If an RF jumper cable is used, the user needs to account for the loss of the cable with an offset value (can be entered into the analyzer).	
FieldFox source control	Yes, on/off, and nominal power level control	No access to FieldFox's source from the built-in power meter mode	



Question	Answer
A. What do I need to get GPS information?	<ol style="list-style-type: none"> <li>The recommended GPS solution is to order: <ul style="list-style-type: none"> <li>Option 307 - built-in GPS receiver</li> <li>A GPS antenna such as N9910X-825</li> <li>Other GPS antennas can also be used</li> <li>The GPS connector on the instrument is SMA (f)</li> </ul> </li> <li>Alternatively, you can purchase a USB-based GPS receiver. You do not need to purchase any FieldFox options for the USB-based GPS to work. However, the USB-based GPS only provides time and location data, and time synchronization capability. It cannot be used to increase the frequency accuracy of the instrument.</li> </ol>
B. What is the connector for Option 309, DC output?	The DC output has a SMB (m) connector. Recommend ordering N9910X Option 713 bias-tee power cable SMB (f) to BNC (m).
C. What are the connectors for the Reference/ Trigger In and Reference / Trigger Out?	The connector for the Ref/Trig In is SMA (f). Recommend ordering N9910X Option 712 Trig/Ref in SMA (m) to BNC (f) cable. The connector for the Ref/Trig Out is SMB (m). Recommend ordering N9910X Option 713 bias-tee power cable SMB (f) to BNC (m).
D. What is Option 030 remote control capability?	<ol style="list-style-type: none"> <li>Option 030 provides a license for FieldFox to allow remote control via an iOS or Android device.</li> <li>Not supplied by user, but necessary for operation of Option 030 are: <ul style="list-style-type: none"> <li>iOS device: iPad, iPhone, or iPod Touch with iOS 6.1 or higher, or Android device with Android OS 9.0 or higher, with free FieldFox app</li> <li>A WiFi or 3G/4G network connection between FieldFox and iOS device or Android device</li> </ul> </li> </ol>
E. What USB sensor is required for Option 330?	Option 330 or pulse measurements requires a Keysight USB peak power sensor. Visit <a href="http://www.keysight.com/find/usbsensorsforfieldfox">www.keysight.com/find/usbsensorsforfieldfox</a> for a list of supported peak power sensors. Average power sensors cannot be used with Option 330, only peak power sensors. The peak power sensor needs to be purchased separately. Option 330 or pulse measurement requires Option 302 and Keysight USB power sensor
F. What measurement capabilities are included with Option 330?	<p>Average power, peak power, and peak to average ratio</p> <p>Analog gauge display and digital display, dBm and watts</p> <p>Relative/absolute measurements, dB or %, minimum and maximum limits</p> <p>Trace graph for pulse profiling with gating</p> <p>Rise time, fall time, pulse width, pulse period, pulse repetition frequency</p>
G. What is included with Option 208?	Option 302, USB power sensor measurements, includes <b>CW</b> power measurements (one frequency at a time). With Option 208 added, you can make <b>swept-frequency</b> power measurements. You can plot source power, gain, and receive power versus frequency. Additionally, the source frequency can be offset from the receiver frequency. The power sensor needs to be purchased separately.

# FieldFox RF and Microwave Signal Analyzers

## Analyzer models

### Step 1. Select the model that provides the desired frequency range.

Model	Description	Frequency range <sup>1</sup>	Test port connectors
N9933B	4 GHz FieldFox signal analyzer	9 kHz to 4 GHz	Type-N (f)
N9934B	6.5 GHz FieldFox signal analyzer	9 kHz to 6.5 GHz	Type-N (f)
N9935B	9 GHz FieldFox signal analyzer	9 kHz to 9 GHz	Type-N (f)
N9936B	14 GHz FieldFox signal analyzer	9 kHz to 14 GHz	Type-N (f)
N9937B	18 GHz FieldFox signal analyzer	9 kHz to 18 GHz	Type-N (f)
N9938B	26.5 GHz FieldFox signal analyzer	9 kHz to 26.5 GHz	Type-N (f) <sup>2</sup>
N9960B	32 GHz FieldFox signal analyzer	9 kHz to 32 GHz	2.4 mm (m)
N9961B	44 GHz FieldFox signal analyzer	9 kHz to 44 GHz	2.4 mm (m)
N9962B	50 GHz FieldFox signal analyzer	9 kHz to 50 GHz	2.4 mm (m)
N9963B	54 GHz FieldFox signal analyzer	9 kHz to 54 GHz	1.8 mm (m)

- Useable to 5 kHz.
- Order Option 100 for 3.5 mm (m) test port connectors. With N9938B-100, the spectrum analyzer is built with 3.5 mm test port connectors instead of the standard Type-N (f). Option 100 is a prerequisite for Option 320 for N9938B.

# Analyzer options

## Step 2. Select optional measurement capabilities.

You can also add any of these options as a software upgrade in the future.

Option	Description	Prerequisite options/notes
<b>Spectrum analysis</b>		
100	3.5 mm (m) connectors	Only available on N9938B. Option 100 is only available at time of purchase. It is not available as an upgrade. It is a prerequisite for Option 320 for N9938B.
209	Extended range transmission analysis (ERTA)	Requires 220. Recommend 307. Requires two FieldFox units. See FAQ # 9. See page 9 for typical configuration.
220	Full-band tracking generator	CW, CW coupled, and tracking
235	Pre-amplifier	—
236	Interference analyzer and spectrogram	—
238	Spectrum analyzer time gating	—
312	Channel scanner	Require the corresponding option to support a specific app. For example, to support EMF in channel scanner requires 358.
320	Reflection measurements (Return Loss, VSWR and Scalar)	320 requires 220 on all models. On N9938B, 320 also requires 100.
350	Real-time spectrum analyzer (RTSA)	Recommend 235. See FAQ # 11
351	I/Q Analyzer (IQA)	—
352	Indoor and outdoor mapping	Requires 307, and at least one of 312, 360, 370, 371, 377 or 378. See FAQ #15
353	IQ streaming	Requires 351
355	Analog demodulation	—
356	Noise Figure (NF)	Requires 235, 309 and accessory item N9910X-713 BNC to SMB cable. See FAQ #13 for external preamplifier and noise source requirements.
358	EMF measurements	Requires triaxial isotropic antenna. See FAQ #16
360	Phased array antenna support	Requires phased array antenna. N991x/3xB (x>5) models require an external mixer. See FAQ #14. No external mixer required for N995x/6xB models.
361	EMI measurements	—
370	Over-the-air (OTA) LTE FDD	Requires 307, recommend 235.
371	Over-the-air (OTA) LTE TDD	Requires 307, recommend 235.
377	Over-the-air (OTA) 5G TF	Requires 307, recommend 235. N991x/3xB (x> 5) models require an external mixer. See FAQ #14. No external mixer required for N995x/6xB models.
378	Over-the-air (OTA) 5G NR	Requires B10 and 307. Recommend 235. N991x/3xB (x>5) models require external mixer for FR2 frequencies above 26.5 GHz. See FAQ #18. No external mixer required for N995x/6xB models.
B04	Analysis bandwidth, 40 MHz <sup>1</sup>	Recommend 350, 351 or PathWave VSA (formerly 89600 VSA) software
B10	Analysis bandwidth, 120 MHz <sup>1</sup>	Recommend 350, 351, 378 or PathWave VSA (formerly 89600 VSA) software
<b>Power measurements</b>		
208	USB power sensor meas. versus frequency	Requires 302. See FAQ I
302	USB power sensor support	Need to order USB power sensor <sup>2</sup> . See FAQ A
310	Built-in power meter	No power sensor required. See FAQ B
330	Pulse meas. with USB peak power sensor	Requires 302 and USB peak power sensor. See FAQ G and FAQ H
320	Reflection measurements (Return Loss, VSWR and Scalar)	Requires 220 on all models. On N9938B specifically, also requires 100.
<b>System features</b>		
030	Remote control capability	Requires an iOS device or an Android device
307	GPS receiver	Need to order GPS antenna, N9910X-825. See FAQ C
309	DC bias variable-voltage source	Recommend N9910X-713 cable, See FAQ D
—	Frequency extender support	Optional 350, 351, 360, 370, 371, 377, 378, PathWave VSA software. See Accessories, pages 19-20
<b>Windows based software</b>		
89601B	PathWave VSA (89600 VSA) software	—
N6820ES	Surveyor 4D software	Requires 235 and 307, see page 7, FAQ #17

1. 10 MHz standard.

2. List of compatible sensors available from [www.keysight.com/find/fieldfoxsupport](http://www.keysight.com/find/fieldfoxsupport).

# FieldFox Signal Analyzer FAQs

Question	Answer
1. What is included with the basic signal analyzer?	Basic spectrum analysis, four traces, different detector types, radio standard selection, limit lines Channel power, occupied bandwidth, adjacent channel power, spectrum emission mask AM/FM tune and listen, field strength measurements, antenna factors, frequency counter marker
2. What is included with Option 236?	Interference analyzer and spectrogram Trace playback and recording
3. What is included with Option 320?	Return loss and VSWR Normalization using data/memory
4. What is the difference between Option 320 and the CAT mode on the combo base model?	Option 320 on the N993x/6xB SA offers RL and VSWR. CAT mode on the N991x/5x combo analyzers offer RL and VSWR, DTF, insertion loss, and various calibration capabilities such as OSL.
5. What is included with Option 355?	FieldFox analog demodulation has two parts: (1) Tune and listen, and (2) AM/FM metrics. Tune and listen are available as a standard feature on all N993x/6x FieldFox spectrum analyzers. AM/FM metrics becomes available when Option 355 is purchased. AM/FM metrics provides the user with RF spectrum view, demodulated baseband signal waveform, carrier power, frequency deviation, SINAD and more.
<b>Additional FAQs</b>	<b>FAQs on pages 6 through 11 apply to all microwave FieldFox models.</b>

## Upgrades

### FieldFox RF and microwave (combination) analyzer upgrades

**N9913BU, N9914BU, N9915BU, N9916BU, N9917BU, N9918BU, N9950BU, N9951BU, N9952BU, N9953BU**



Information on upgrades is available from: [www.keysight.com/find/fieldfoxsupport](http://www.keysight.com/find/fieldfoxsupport)

Option	Description	Upgrade contents	Additional requirements
010	VNA time domain analysis	License key	Requires 210, recommend 211
030	Remote control capability	License key	Requires an iOS device or an Android device
208	USB power sensor measurements versus frequency	License key	Requires 302
209	Extended range transmission analysis (ERTA)	License key	Requires 233 and 210 <sup>1</sup> , recommend 307
210	VNA transmission and reflection	License key	None
211	VNA full 2-port S-parameters	License key	Requires 210
212	Mixed-mode S-parameters	License key	Requires 210 and 211
215	TDR cable measurements	License key	None
233	Spectrum analyzer	License key	None
235	Preamplifier	License key	Requires 233
236	Interference analyzer and spectrogram	License key	Requires 233
238	Spectrum analyzer time gating	License key	Requires 233
302	External USB power sensor support	License key	None
307	GPS receiver	License key	None
308	Vector voltmeter	License key	Requires 210 and 211 for full VVM functionality
309	DC bias variable-voltage source	License key	Recommend N9910X-713 cable
310	Built-in power meter	License key	None
312	Channel scanner	License key	Requires 233
330	Pulse measurements	License key	Requires 302 and USB peak power sensor
350	Real-time spectrum analyzer (RTSA)	License key	Requires 233, recommend 235
351	I/Q Analyzer (IQA)	License key	Requires 233
352	Indoor and outdoor mapping	License key	Requires 233, 307, and at least one of 312, 360, 370, 371, 377 or 378.
353	IQ streaming	License key	Requires 233 and 351
355	Analog demodulation	License key	Requires 233
356	Noise figure (NF)	License key <sup>2</sup>	Requires 233, 235, 309 and accessory cable N9910X-713
358	EMF measurements	License key	Requires 233. Also requires triaxial isotropic antenna. See <a href="#">FAQ #16</a>

Option	Description	Upgrade contents	Additional requirements
360	Phased array antenna support	License key	Requires 233. Also requires phased array antenna. See <a href="#">FAQ #14</a>
361	EMI measurements	License key	Requires 233
370	Over-the-air (OTA) LTE FDD	License key	Requires 233 and 307, recommend 235
371	Over-the-air (OTA) LTE TDD	License key	Requires 233 and 307, recommend 235
377	Over-the-air (OTA) 5G TF <sup>3</sup>	License key	Requires 233 and 307, recommend 235
378	Over-the-air (OTA) 5G NR	License key	Requires 233, B10, and 307, recommend 235; N991x/3xB models require external mixer for FR2 frequencies above 26.5 GHz. See <a href="#">FAQ #18</a>
390	Directional finding - time difference of arrival (TDOA) node support	License key	Requires 233, 307 and PC software S9910A/S9911A, recommend 235; requires 3 or 4 networked FieldFox analyzers
391	Directional finding – angle of arrival (AoA)	License key	Requires 233, 307, recommend 235
B04	Analysis bandwidth, 40 MHz <sup>4</sup>	License key	Requires 233. Recommend 350, 351 or PathWave VSA (formerly 89600 VSA) software
B10	Analysis bandwidth, 120 MHz <sup>4</sup>	License key	Requires 233. Recommend 350, 351, 378 or PathWave VSA (formerly 89600 VSA) software
S70	OTA 5G NR and LTE FDD/TDD cellular measurements, node-locked 12-month subscription <sup>5</sup>	License key	Requires 233, B10, 235, and 307
S9910A	Keysight signal management software	PC software license	Installed in an external PC, pre-requisite for S9911A
S9911A	Directional finding - TDOA	PC software license	Installed in an external PC, requires 1 PC for the networked FieldFox analyzers installed with 390

- Option 209 is a system based on two FieldFox units. See [FAQ #9](#), for a detailed description of the system requirements.
- See [FAQ #13](#) for external preamplifier and noise source requirements.
- Requires external mixer for N991xB (x>5) models. See [FAQ #14](#). No external mixer required for N995xB.
- 10 MHz standard.
- If the 12-month subscription is expiring and needs to be extended, re-order Option BU-S70 for another period of 12 months.

## FieldFox signal analyzer upgrades

### N9933BU, N9934BU, N9935BU, N9936BU, N9937BU, N9938BU, N9960BU, N9961BU, N9962BU, N9963BU

Option	Description	Upgrade contents	Additional requirements
030	Remote control capability	License key	Requires an iOS device or an Android device
100	3.5 mm connectors	Not applicable	Not applicable
208	USB power sensor measurements versus frequency	License key	Requires 302
209	Extended range transmission analysis (ERTA)	License key	Requires 220 <sup>1</sup> , recommend 307
220	Full-band tracking generator	License key	None
235	Preamplifier	License key	None
236	Interference analyzer and spectrogram	License key	None
238	Spectrum analyzer time gating	License key	None
302	External USB power sensor support	License key	None
307	GPS receiver	License key	None
309	DC bias variable-voltage source	License key	Recommend N9910X-713 cable
310	Built-in power meter	License key	None
312	Channel scanner	License key	None
320	Reflection measurements (Return Loss, VSWR and Scalar)	License key <sup>2</sup>	Option 220 for all models Option 100 and 220 for N9938B
330	Pulse measurements	License key	Requires 302 and USB peak power sensor
350	Real-time spectrum analyzer (RTSA)	License key	Recommend 235
351	I/Q Analyzer (IQA)	License key	None
352	Indoor and outdoor mapping	License key	Requires 307, and at least one of 312, 360, 370, 371, 377 or 378.
353	IQ streaming	License key	Requires 351
355	Analog demodulation	License key	None
356	Noise figure (NF)	License key <sup>3</sup>	Requires 235, 309 and accessory cable N9910X-713
358	EMF measurements	License key	Requires triaxial isotropic antenna. See <a href="#">FAQ #16</a>
360	Phased array antenna support	License key	Requires phased array antenna. External mixer for N991xB/3xB. See <a href="#">FAQ#14</a>
361	EMI measurements	License key	None

Option	Description	Upgrade contents	Additional requirements
370	Over-the-Air (OTA) LTE FDD	License key	Requires 307, recommend 235
371	Over-the-Air (OTA) LTE TDD	License key	Requires 307, recommend 235
377	Over-the-Air (OTA) 5G TF <sup>4</sup>	License key	Requires 307, recommend 235
378	Over-the-air (OTA) 5G NR	License key	Requires B10 and 307, recommend 235. N993xB models require external mixer for FR2 frequencies above 26.5 GHz. See <a href="#">FAQ #18</a>
390	Directional finding - time difference of arrival (TDOA) node support	License key	Requires 307 and PC software S9910A/S9911A, recommend 235; requires 3 or 4 networked FieldFox analyzers
391	Directional finding – angle of arrival (AoA)	License key	Requires 307, recommend 235
B04	Analysis bandwidth, 40 MHz <sup>5</sup>	License key	Recommend 350, 351 or PathWave VSA (formerly 89600 VSA) software
B10	Analysis bandwidth, 120 MHz <sup>5</sup>	License key	Recommend 350, 351 or PathWave VSA (formerly 89600 VSA) software
S70	OTA 5G NR and LTE FDD/TDD cellular measurements, node-locked 12-month subscription <sup>6</sup>	License key	Requires B10, 235, and 307
S9910A	Keysight signal management software	PC software license	Installed in an external PC, pre-requisite for S9911A
S9911A	Directional finding - TDOA	PC software license	Installed in an external PC, requires 1 PC for the networked FieldFox analyzers installed with 390

1. For N9938B, Option 320 is only available as a software upgrade if the spectrum analyzer is already equipped with Option 100, which is 3.5 connectors on the test port. Option 100 must have been ordered at the time of original purchase. It cannot be added later.
2. Option 209 is a system based on two FieldFox units. See [FAQ #9](#), for a detailed description of the system requirements.
3. See [FAQ #13](#) for external preamplifier and noise source requirements.
4. Requires external mixer for N993xB (x>5) models. See [FAQ #14](#). No external mixer required for N996xB.
5. 10 MHz standard.
6. If the 12-month subscription is expiring and needs to be extended, re-order Option BU-S70 for another period of 12 months.



# Documentation

By default, a printed copy of the User's Guide is not included in FieldFox orders. If you wish to receive the printed User's Guide, please order N99xxA Option ABA.

Option	Description	Notes
N99xxA-0B0	Do not include User's Guide	
N99xxA-ABA	Printed User's Guide in English	

The latest FieldFox User's Guide (manual) is available online from:

[www.keysight.com/find/fieldfoxsupport](http://www.keysight.com/find/fieldfoxsupport).

The Service Guide, SCPI Programming Guide, Quick Reference Guide, and Data Link software help file can also be found via the website above.

## Calibration Kits

FieldFox analyzers support most standard HP/Agilent/Keysight mechanical calibration kits and all Keysight USB ECal modules. Component list shows calibration components, some calibration kits also include adaptors. Custom calibration kits can be created and uploaded to FieldFox using Data Link software.

Model	Description	Connector	Frequency range	Components
<b>7-16</b>				
N9910X-802	3-in-1 OSL Cal kit	7/16 (m)	DC to 4 GHz	Open, short, load (all male)
N9910X-803	3-in-1 OSL Cal kit	7/16 (f)	DC to 4 GHz	Open, short, load (all female)
85038A	Standard cal kit	7/16	DC to 7.5 GHz	Open, short, load (both female and male)
<b>Type-N, 50 Ω</b>				
N9910X-800 <sup>1</sup>	3-in-1 OSL cal kit	Type-N (m)	DC to 6 GHz	Open, short, load (all male)
N9910X-801 <sup>1</sup>	3-in-1 OSL cal kit	Type-N (f)	DC to 6 GHz	Open, short, load (all female)
85032E	Economy cal kit	Type-N (m)	DC to 6 GHz	Open, short, load (all male)
85514A	4-in-1 OSLT cal kit	Type-N (m)	DC to 9 GHz	Open, short, load, thru (all male)
85515A	4-in-1 OSLT cal kit	Type-N (f)	DC to 9 GHz	Open, short, load, thru (all female)
85032F	Standard cal kit	Type-N	DC to 9 GHz	Open, short, load (both female and male)
85518A	4-in-1 OSLT cal kit	Type-N (m)	DC to 18 GHz	Open, short, load, thru (all male)
85519A	4-in-1 OSLT cal kit	Type-N (f)	DC to 18 GHz	Open, short, load, thru (all female)
85054D	Economy cal kit	Type-N	DC to 18 GHz	Open, short, load, thru (both female and male)
85054B	Standard cal kit	Type-N	DC to 18 GHz	Open, short, fixed load, sliding load (both female and male)
85092C	ECal, 2-ports	Type-N	300 kHz to 9 GHz	Connectors configurable
N4690B/C	ECal, 2-ports	Type-N	300 kHz to 18 GHz	Connectors configurable
N4690D	ECal, 2-ports	Type-N	300 kHz to 18 GHz or DC to 18 GHz	Connectors configurable
N7550A	ECal economy, 2-ports	Type-N	DC to 4 GHz	Connectors configurable
N7551A	ECal economy, 2-ports	Type-N	DC to 6.5 GHz	Connectors configurable
N7552A	ECal economy, 2-ports	Type-N	DC to 9 GHz	Connectors configurable
N7553A	ECal economy, 2-ports	Type-N	DC to 14 GHz	Connectors configurable
N7554A	ECal economy, 2-ports	Type-N	DC to 18 GHz	Connectors configurable
<b>Type-N, 75 Ω <sup>1</sup></b>				
85036B	Standard cal kit	Type-N 75 Ω	DC to 3 GHz	Open, short, load (both female and male)
85036E	Economy cal kit	Type-N(m) 75 Ω	DC to 3 GHz	Open, short, load, all male
85096C	ECal, 2-ports	Type-N(m) 75 Ω	300 kHz to 3 GHz	Connectors configurable



Model	Description	Connector	Frequency range	Components
<b>3.5 mm</b>				
85520A	4-in-1 OSLT	3.5 mm (m)	DC to 26.5 GHz	Open, short, load, thru (all male)
85521A	4-in-1 OSLT	3.5 mm (f)	DC to 26.5 GHz	Open, short, load, thru (all female)
85033D/E	Economy cal kit	3.5 mm	DC to 6/9 GHz	Open, short, fixed load (both female and male)
85052D	Economy cal kit	3.5 mm	DC to 26.5 GHz	Open, short, fixed load (both female and male)
85052B	Standard cal kit	3.5 mm	DC to 26.5 GHz	Open, short, fixed load, sliding load (both female and male)
85052C	Precision TRL kit	3.5 mm	DC to 26.5 GHz	Open, short, fixed load (both female and male), two-line lengths
85093C	ECal, 2-ports	3.5 mm	300 kHz to 9 GHz	Connectors configurable
N4691B <sup>2</sup>	ECal, 2-ports	3.5 mm	300 kHz to 26.5 GHz	Connectors configurable
N4691D	ECal, 2-ports	3.5 mm	300 kHz to 26.5 GHz or DC to 26.5 GHz	Connectors configurable
N7550A	ECal economy, 2-ports	3.5 mm	DC to 4 GHz	Connectors configurable
N7551A	ECal economy, 2-ports	3.5 mm	DC to 6.5 GHz	Connectors configurable
N7552A	ECal economy, 2-ports	3.5 mm	DC to 9 GHz	Connectors configurable
N7553A	ECal economy, 2-ports	3.5 mm	DC to 14 GHz	Connectors configurable
N7554A	ECal economy, 2-ports	3.5 mm	DC to 18 GHz	Connectors configurable
N7555A	ECal economy, 2-ports	3.5 mm	DC to 26.5 GHz	Connectors configurable
<b>2.92 mm (same as K connector)</b>				
85561A	4-in-1 OSLT cal kit	2.92 mm (f)	DC to 40 GHz	Open, short, fixed load, thru (all female)
85562A	4-in-1 OSLT cal kit	2.92 mm (m)	DC to 40 GHz	Open, short, fixed load, thru (all male)
85056KE01 <sup>3</sup>	Standard cal kit	2.92 mm	DC to 40 GHz	Open, short, fixed load, sliding load (both female and male)
85056KE02 <sup>4</sup>	Economy cal kit	2.92 mm	DC to 40 GHz	Open, short, fixed load (both female and male)
N4692A <sup>2</sup>	ECal	2.92 mm	10 MHz to 40 GHz	Connectors configurable
<b>2.4 mm</b>				
85563A	3-in-1 OSL cal kit	2.4 mm (f)	DC to 50 GHz	Open, short, fixed load (all female)
85564A	3-in-1 OSL cal kit	2.4 mm (m)	DC to 50 GHz	Open, short, fixed load (all male)
85056D	Economy cal kit	2.4 mm	DC to 50 GHz	Open, short, fixed load (both female and male)
85056A	Standard cal kit	2.4 mm	DC to 50 GHz	Open, short, load, fixed load, sliding load (both female and male)
N4693A <sup>2</sup>	ECal	2.4 mm	10 MHz to 50 GHz	Connectors configurable
<b>1.85 mm</b>				
85058E	Economy cal kit	1.85 mm	DC to 67 GHz	Open, short, fixed load (female and male)
N4694A <sup>2</sup>	ECal	1.85 mm	10 MHz to 67 GHz	Connectors configurable
N4694D	ECal	1.85 mm	10 MHz to 67 GHz or DC to 67 GHz	Connectors configurable
<b>Waveguide</b>				
N9911X-11x	Econ. waveguide cal kit	WR-137	5.38 to 8.18 GHz	Short, termination, offset length
N9911X-21x	Econ. waveguide cal kit	WR-90	8.2 to 12.5 GHz	Short, termination, offset length
N9911X-31x	Econ. waveguide cal kit	WR-62	11.9 to 18 GHz	Short, termination, offset length
N9911X-41x	Econ. waveguide cal kit	WR-42	17.6 to 26.7 GHz	Short, termination, offset length
X11644A	Waveguide cal kit	WR-90	8.2 to 12.4 GHz	Short, shim, termination, standard section
P11644A	Waveguide cal kit	WR-62	12.4 to 18 GHz	Short, shim, termination, standard section
K11644A	Waveguide cal kit	WR-42	18 to 26.5 GHz	Short, shim, termination, standard section

1. Recommend ordering quantity 2 of N9910X Option 846, 50 to 75 Ω adapter.

2. Product is discontinued.

3. Same as Maury's 8770C47.

4. Same as Maury's 8770D47.

# Accessories

## Cables

All cables listed below are rugged phase-stable cables.

Model	Cable connector	Other cable connector	Max frequency	Length (ft)	Length (m)
N9910X-700	Type-N (m)	Type-N (f)	18 GHz	3.28 ft	1 m
N9910X-701	Type-N (m)	Type-N (m)	18 GHz	3.28 ft	1 m
N9910X-704	Type-N (m)	TNC (f)	13 GHz	5 ft	1.5 m
N9910X-705	Type-N (m)	TNC (m)	13 GHz	5 ft	1.5 m
N9910X-708	3.5 mm (m)	3.5 mm (f)	26.5 GHz	3.28 ft	1 m
N9910X-709	3.5 mm (f)	3.5 mm (f)	26.5 GHz	3.28 ft	1 m
N9910X-714	2.4 mm (f)	2.4 mm (m)	50 GHz	3.28 ft	1 m
N9910X-715	2.4 mm (f)	2.4 mm (f)	50 GHz	3.28 ft	1 m
N9910X-716	Type-N (m)	Type-N (m)	18 GHz	2 ft	0.61 m
N9910X-718	2.4 mm (f)	K / 2.92 mm (m)	40 GHz	3 ft	0.914 m
N9910X-810	Type-N (m)	Type-N (m)	8 GHz	5 ft	1.5 m
N9910X-811	Type-N (m)	Type-N (f)	8 GHz	5 ft	1.5 m
N9910X-812	Type-N (m)	Type-N (m)	8 GHz	12 ft	3.6 m
N9910X-813	Type-N (m)	Type-N (f)	8 GHz	12 ft	3.6 m
N9910X-814	Type-N (m)	7/16 (m)	6 GHz	5 ft	1.5 m
N9910X-815	Type-N (m)	7/16 (m)	6 GHz	12 ft	3.6 m
N9910X-816	Type-N (m)	Type-N (f)	6 GHz	3.28 ft	1 m
N9910X-817	Type-N (m)	Type-N (m)	6 GHz	3.28 ft	1 m

## Preamplifiers

U7227A	USB preamplifier, 10 MHz to 4 GHz	<a href="http://www.keysight.com/find/U7227A">www.keysight.com/find/U7227A</a>
U7227C	USB preamplifier, 100 MHz to 26.5 GHz	<b>Error! Hyperlink reference not valid.</b> <a href="http://www.keysight.com/find/U7227C">www.keysight.com/find/U7227C</a>
U7227F	USB preamplifier, 2 to 50 GHz	<a href="http://www.keysight.com/find/U7227F">www.keysight.com/find/U7227F</a>
U7228A	USB preamplifier, 10 MHz to 4 GHz	<a href="http://www.keysight.com/find/U7228A">www.keysight.com/find/U7228A</a>
U7228C	USB preamplifier, 100 MHz to 26.5 GHz	<a href="http://www.keysight.com/find/U7228C">www.keysight.com/find/U7228C</a>
U7228F	USB preamplifier, 2 to 50 GHz	<a href="http://www.keysight.com/find/U7228F">www.keysight.com/find/U7228F</a>

## Noise sources

346A/B/C/K01/K40	Noise source family	<a href="http://www.keysight.com/find/346noisesources">www.keysight.com/find/346noisesources</a>
------------------	---------------------	--

## Antennas

N9910X-820	Antenna, directional, multiband, 800 to 2500 MHz, 10 dBi, Type-N (f)
N9910X-821	Antenna, telescopic whip, 70 MHz to 1 GHz, BNC (m)
N9910X-822	Antenna, directional, log periodic, 600 MHz to 9 GHz, Type-N (f)
N9910XA-823 <sup>1</sup>	Antenna, cellular narrowband, 824 to 869 MHz, Type-N (f)
N9910XA-824 <sup>1</sup>	Antenna, cellular narrowband, PCS 1850 to 1990 MHz, Type-N (f)
N9910X-825	Antenna, GPS, active, SMA (m)
85571A-028 <sup>1</sup>	5G Phased Array Antenna 28 GHz
85572A-006	Triaxial Isotropic Antenna 30 MHz to 6 GHz

1. Currently not RoHS compliant.

## RF and microwave adapters

83059A	Coaxial adapter, 3.5 mm (m) to 3.5 mm (m), 26.5 GHz
83059B	Coaxial adapter, 3.5 mm (f) to 3.5 mm (f), 26.5 GHz
83059C	Coaxial adapter, 3.5 mm (m) to 3.5 mm (f), 26.5 GHz
N9910X-601	Coaxial adapter, NMD 2.4 mm (f) to Type-N (f), 50-ohm, 18 GHz
N9910X-602	Coaxial adapter, NMD 2.4 mm (f) to 2.92 mm/K (f), 40 GHz
N9910X-603	Coaxial adapter, NMD 2.4 mm (f) to 3.5 mm (f), 26.5 GHz
N9910X-604	3.5 mm NMD (f) to 3.5 mm (f) adapter, 26.5 GHz
N9910X-605	3.5 mm NMD (f) to Type-N (f) adapter, 18 GHz
N9910X-843	Coaxial adapter, Type-N (m) to 7/16 DIN (f)
N9910X-845	Adapter kit: Type-N (f) to 7/16 DIN (f), Type-N (f) to 7/16 DIN (m), Type-N (f) to Type-N (f)
N9910X-846	Coaxial adapter, Type-N (m) 50 ohm to Type-N (f) 75 ohm
N9910X-847	Adapter kit: Type-N (f) to TNC (m) adapter, Type-N (f) to TNC (f) adapter, 10 GHz
N9910X-848	Coaxial adapter, Type-N (f) to 3.5 mm (f), 18 GHz
N9910X-849	Coaxial adapter, Type-N (f) to 3.5 mm (m), 18 GHz
N9910X-850	Coaxial adapter, Type-N (m) to Type-N (m), 18 GHz
N9910X-851	Coaxial adapter, Type-N (f) to Type-N (f), 18 GHz
N9910X-852	Coaxial adapter, Type-N (m) to Type-N (f), 18 GHz
N9910X-856	Coaxial adapter, 2.4 mm (f) to 2.4 mm (f), 50 GHz
N9910X-857	Coaxial adapter, 2.4 mm (f) to 2.92 mm/K (f), 40 GHz

## OML frequency extender modules

OML frequency extenders can be purchased directly through OML, Inc. One mixer, OML model number M28H2ADC-K (24 to 40 GHz), has been set up as a Keysight special handling part number N9910XM28-H2A for 3.5 mm test ports or N9910XM28-H2N for Type-N test ports and they are available for sale directly through Keysight. Contact OML, Inc. directly ([www.omlinc.com](http://www.omlinc.com)) for pricing, ordering and datasheet information or contact a Keysight representative for assistance.

FieldFox operating modes that support frequency extenders include: Spectrum analyzer, real-time spectrum analyzer, I/Q analyzer, over-the-air (LTE FDD, 5GTF), phased array antenna support and PathWave vector signal analysis software (formerly 89600 VSA).

OML model number	OML mixer frequency range	Frequency range with FieldFox models N9917/18/5xB and N9937/38/6xB	Frequency range with FieldFox models N9916/36B
M28H2ADC-K <sup>1</sup>	24 to 40 GHz	24 to 40 GHz	24 to 34 GHz
M15H4ADC	50 to 75 GHz	50 to 75 GHz	50 to 62 GHz
M12H6ADC	60 to 90 GHz	60 to 90 GHz	60 to 90 GHz
M10H6ADC	75 to 110 GHz	75 to 110 GHz	75 to 90 GHz

1. Not applicable to N9951/61B, N9952/62B, and N9953/63B models with maximum frequency coverage of 44, 50, and 54 GHz, respectively.

## OML frequency extender module adapter kits

OML frequency extender module adapter kits make for easier connection to FieldFox units with Type-N or 3.5 mm. Frequency extender adaptors work with OML frequency extender model number **M28H2ADC-K** (24 to 40 GHz), or Keysight special handling part number N9910XM28-H2A that is available for sale directly through Keysight. Alternatively, Keysight also offers a special handling part number **N9910XM28-H2N that has Type-N (m) connectors for LO input and IF output. Users can connect the frequency extender directly to the FieldFox analyzer with Type-N test ports eliminating the need for adapters. Please see N9910XM28 web page** for more detailed information.

When ordering the OML frequency extender as Keysight model number **N9910XM28-H2A**, add the adapter kits shown below as Keysight model numbers N9910XM28-AK1, -AK2, -AK3, -AK4 and -AK5.

When ordering the OML frequency extender as Keysight model number **N9910XM28-H2N**, add the adapter kits shown below as Keysight model numbers N9910XM28-AK4, -AK5, and -AK6. (Note -AK1, -AK2, and -AK3 are intended for N9910XM28-H2A only)

Model number	Description
N9910XM28-AK1	Coaxial straight Male-N to Male-SMA, Qty 2 included, connects the mixer model N9910XM28-H2A, with SMA LO and IF connectors, directly to the FieldFox with Type-N ports, for example FieldFox Model N9917B. The new mixer Model N9910XM28-H2N has Type-N LO and IF connections for direct connection to the FieldFox N9917B.
N9910XM28-AK2	Coaxial straight Female-SMA to Female-N, Qty 2 included, used as a spacer with N9910XM28-AK1 for FieldFox units with 3.5 mm ports when the GPS antenna is mounted vertically.
N9910XM28-AK3	Coaxial straight Male-SMA to Female-SMA, Qty 2 included, connects mixer directly to FieldFox with 3.5 mm ports. Required to provide space for the GPS Antenna when used with right angle adapter N9010XM28-AK4.
N9910XM28-AK4	Female-SMA to Male-SMA, Right Angle, Qty 1, included. For connecting GPS antenna at right angle and used for GPS antenna attachment with N9910XM28-AK1 or N9910XM28-AK3 adapter kits. Can also be used to provide a right-angle connection to Ref/Trig input.
N9910XM28-AK5	Waveguide horn antenna and mounting fixture.
N9910XM28-AK6	Type-N Male-Female adapter. Acts as a spacer to offset the mixer from the FieldFox to allow access to the Trig/Ref input connector which is blocked by the USB Mini connector when the N9910XM28-H2N is connected directly.

When ordering the OML frequency extender adapter kits separately (not added to an order with Keysight model number N9910XM28-H2A or N9910XM28-H2N), order the adapter kits shown above (N9910XM28-AKx) as the Keysight part numbers shown below.

Part number	Description
1250-1636	Coaxial straight Male-N to Male-SMA, order Qty 2, connects mixer directly to FieldFox with Type-N ports. See N9910XM28-AK1 complete description above.
1250-3968	Coaxial straight Female-SMA to Female-N, order Qty 2, spacer for FieldFox units with 3.5 mm ports and used with (part number 1250-1636 adapter kit shown above) when GPS antenna is mounted vertically.
1250-3851	Coaxial straight Male-SMA to Female-SMA, order Qty 2, connects mixer directly to FieldFox with 3.5 mm ports.
N0000-33203	Female-SMA to Male-SMA, Right Angle, Qty 1, for connecting GPS antenna at right angle and used for GPS antenna attachment with (part number 1250-1636 or 1250-3851 adapter kits shown above).
0950-6352	Antenna and mounting fixture, 0.75-inch square flange plastic, Qty 1 included, to be used with 0955-3591 below.
0955-3591	Waveguide horn antenna, pyramidal Ka-band 26.5 to 40 GHz WR-28, Qty 1 included, also order 0950-6352 above for mounting fixture.
85032-60020	Type-N Male-Female adapter. Acts as a spacer to offset the mixer from the FieldFox to allow access to the Trig/Ref input connector which is blocked by the USB Mini connector when the N9910XM28-H2N is connected directly.

### Other RF and microwave accessories

Model	Description
N9910X-860	Fixed attenuator, 40 dB, 100 W, DC to 3 GHz, Type-N (m) to Type-N (f)
N9910X-861	Fixed attenuator, 40 dB, 50 W, DC to 8.5 GHz, Type-N (m) to Type-N (f)
N9910X-874 <sup>1</sup>	External bias-tee, 2.5 MHz to 6 GHz, 1 W, 0.5 A
N9910X-886	Torque wrench, 17 mm, 90 N-cm (8 in-lb), used for connecting with 3.5 mm, 2.4 mm, or 1.85 mm connectors
N9910X-712	Trig/Ref in Cable SMA (m) to BNC (f), 1 m or 3.28 ft
N9910X-713	Bias-tee power cable SMB (f) to BNC (m), 1 m or 3.28 ft

### Other FieldFox accessories

N9910X-876	Extra highcapacity battery
N9910X-872	External battery charger
N9910X-873	AC/DC adapter
N9910X-875	DC car charger and adapter
N9910X-880	Extra soft carrying case with backpack and shoulder strap
N9910X-881	Hard transit case
N9910X-886	Torque wrench, 17 mm, 90 N-cm (8 in-lb), recommended for N995xA and N996xA analyzers
N9910X-895	Magnetic mount base for antenna















1. Also recommend ordering N9910X-713 Bias-Tee Power Cable, SMB(f) to BNC(m), 3.28 ft., to connect to the FieldFox DC source.

Keysight power sensors supported with FieldFox (options 208, 302, or 330)

Model number	USB or LAN	Sensor type	Frequency and power range
U2000A	USB	Average	10 MHz to 18 GHz, -60 dBm to +20 dBm
U2000B	USB	Average	10 MHz to 18 GHz, -30 dBm to +44 dBm
U2000H	USB	Average	10 MHz to 18 GHz, -50 dBm to +30 dBm
U2001A	USB	Average	10 MHz to 6 GHz, -60 dBm to +25 dBm
U2001B	USB	Average	10 MHz to 6 GHz, -30 dBm to +44 dBm
U2001H	USB	Average	10 MHz to 6 GHz, -50 dBm to +30 dBm
U2002A	USB	Average	50 MHz to 24 GHz, -60 dBm to +20 dBm
U2002H	USB	Average	50 MHz to 24 GHz, -50 dBm to +30 dBm
U2004A	USB	Average	9 kHz to 6 GHz, -60 dBm to +20 dBm
U2021XA	USB	Average and peak	50 MHz to 18 GHz, -30 dBm to +20 dBm
U2022XA	USB	Average and peak	50 MHz to 40 GHz, -30 dBm to +20 dBm
U2041XA	USB	Average	10 MHz to 6 GHz, -70 dBm to +26 dBm
U2042XA	USB	Average and peak	10 MHz to 6 GHz, -70 dBm to +26 dBm
U2043XA	USB	Average	10 MHz to 18 GHz, -70 dBm to +26 dBm
U2044XA	USB	Average and peak	10 MHz to 18 GHz, -70 dBm to +26 dBm
U2051XA	USB	Average	10 MHz to 6 GHz, -70 dBm to +26 dBm
U2052XA	USB	Average	10 MHz to 18 GHz, -70 dBm to +26 dBm
U2053XA	USB	Average	10 MHz to 33 GHz, -70 dBm to +26 dBm
U2054XA	USB	Average	10 MHz to 40 GHz, -70 dBm to +20 dBm
U2055XA	USB	Average	10 MHz to 50/53 GHz, -70 dBm to +20 dBm
U2056XA	USB	Average	10 MHz to 54 GHz, -70 dBm to +20 dBm ( $\leq 50$ GHz), to +15 dBm ( $\leq 54$ GHz)
U2057XA	USB	Average	10 MHz to 67 GHz, -70 dBm to +20 dBm ( $\leq 50$ GHz), to +15 dBm ( $\leq 54$ GHz), to +10 dBm ( $\leq 67$ GHz)
U2066XA	USB	Average and peak	10 MHz to 54 GHz, -70 dBm to +20 dBm ( $\leq 50$ GHz), to +15 dBm ( $\leq 54$ GHz)
U2067XA	USB	Average and peak	10 MHz to 67 GHz, -70 dBm to +20 dBm ( $\leq 50$ GHz), to +15 dBm ( $\leq 54$ GHz), to +10 dBm ( $\leq 67$ GHz)
U2063XA	USB	Average and peak	10 MHz to 33 GHz, -70 dBm to +20 dBm
U2064XA	USB	Average and peak	10 MHz to 40 GHz, -70 dBm to +20 dBm
U2065XA	USB	Average and peak	10 MHz to 50/53 GHz, -70 dBm to +20 dBm
U8481A	USB	Average	10 MHz to 18 GHz, -35 dBm to +20 dBm
U8485A	USB	Average	10 MHz to 33 GHz, -35 dBm to +20 dBm
U8487A	USB	Average	10 MHz to 50 GHz, -35 dBm to +20 dBm
U8488A	USB	Average	10 MHz to 67 GHz, -35 dBm to +20 dBm
U8489A	USB	Average	DC to 120 GHz, -35 dBm to +20 dBm
L2051XA	LAN	Average	10 MHz to 6 GHz, -70dBm to +26 dBm
L2052XA	LAN	Average	10 MHz to 18 GHz, -70dBm to +26 dBm
L2053XA	LAN	Average	10 MHz to 33 GHz, -70dBm to +26 dBm
L2054XA	LAN	Average	10 MHz to 40 GHz, -70dBm to +20 dBm
L2055XA	LAN	Average	10 MHz to 50/53 GHz, -70dBm to +20 dBm
L2056XA	LAN	Average	10 MHz to 54 GHz, -70 dBm to +20 dBm ( $\leq 50$ GHz), to +15 dBm ( $\leq 54$ GHz)
L2057XA	LAN	Average	10 MHz to 67 GHz, -70 dBm to +20 dBm ( $\leq 50$ GHz), to +15 dBm ( $\leq 54$ GHz), to +10 dBm ( $\leq 67$ GHz)
L2061XA	LAN	Average and peak	10 MHz to 6 GHz, -70dBm to +26 dBm
L2062XA	LAN	Average and peak	10 MHz to 18 GHz, -70dBm to +26 dBm
L2063XA	LAN	Average and peak	10 MHz to 33 GHz, -70dBm to +26 dBm
L2064XA	LAN	Average and peak	10 MHz to 40 GHz, -70dBm to +20 dBm
L2065XA	LAN	Average and peak	10 MHz to 50/53 GHz, -70dBm to +20 dBm
L2065XT	LAN	Average and peak	10 MHz to 53 GHz, -70dBm to +20 dBm
L2066XA	LAN	Average and peak	10 MHz to 54 GHz, -70 dBm to +20 dBm ( $\leq 50$ GHz), to +15 dBm ( $\leq 54$ GHz)
L2067XA	LAN	Average and peak	10 MHz to 67 GHz, -70 dBm to +20 dBm ( $\leq 50$ GHz), to +15 dBm ( $\leq 54$ GHz), to +10 dBm ( $\leq 67$ GHz)
L2065XT	LAN	Thermal Vacuum Compliance	10 MHz to 53 GHz, -70 dBm to +20 dBm
L2066XT	LAN	Thermal Vacuum Compliance	10 MHz to 54 GHz, -70 dBm to +20 dBm ( $\leq 50$ GHz), to +15 dBm ( $\leq 54$ GHz)
L2067XT	LAN	Thermal Vacuum Compliance	10 MHz to 67 GHz, -70 dBm to +20 dBm ( $\leq 50$ GHz), to +15 dBm ( $\leq 54$ GHz), to +10 dBm ( $\leq 67$ GHz)
U2049XA	LAN	Average and peak	10 MHz to 33 GHz, -70dBm to +20 dBm











Description	Accessory	Description	Accessory
N9910X-701 Type-N (m) to Type-N (m) cable, 3.28 ft		N9910X-881 Hard transit case	
N9910X-708 3.5 mm (m) to 3.5 mm (f) cable, 3.28 ft		N9910X-812 Type-N (m) to Type-N (m) cable, 12 ft	
N9910X-820 Antenna, directional		N9910X-816 Type-N (m) to Type-N (f) cable, 3.28 ft	
N9910XA-823 Antenna, cellular narrowband		N9910X-821 Antenna, telescopic whip™	
N9910X-822 Antenna, directional		N9910X-848 Coaxial adapter, Type-N(f) to 3.5 mm (f)	
N9910X-825 Antenna, GPS, active		N9910X-875 DC car charger and adapter	
N9910X-876 Extra high-capacity battery		N9910X-873 AD/DC adapter	
N9910X-872 External battery charger		N9910X-874 External bias-tee	
N4690B <sup>1</sup> 2-port ECal, Type-N, 18 GHz		85054D Economy cal kit, Type-N, 18 GHz	

1. Discontinued

Description	Accessory	Description	Accessory
N9910X-800 3-in-1 OSL cal kit, Type-N (m), 6 GHz		N9910X-801 3-in-1 OSL cal kit, Type-N (f), 6 GHz	
N9910X-811 Type-N (m) to Type-N (f) cable, 5 ft		85520A 4-in-1 OSLT cal kit, 3.5 mm (m), 26.5 GHz	
85514A 4-in-1 OSLT cal kit, Type-N (m), 9 GHz		85521A 4-in-1 OSLT cal kit, 3.5 mm (f), 26.5 GHz	
85515A 4-in-1 OSLT cal kit, Type-N (f), 9 GHz		85518A 4-in-1 OSLT cal kit, Type-N (m), 18 GHz	
85519A 4-in-1 OSLT cal kit, Type-N (f), 18 GHz		85572A-006 Triaxial Isotropic Antenna (30 MHz to 6 GHz)	
N9911X-211/212/213/214 WR-90 economical cal kit		85571A-028 <sup>1</sup> 5G Phase Array Antenna 28 GHz	
N4691B <sup>2</sup> 2-port ECal, 3.5 mm, 26.5 GHz		N4692A <sup>2</sup> 2.92 mm, 2-port ECal, 40 GHz	

1. Not currently RoHS compliant  
2. Discontinued



Description	Accessory	Description	Accessory
N4693A <sup>1</sup> 2.4 mm 2-port ECal, 50 GHz		N4691D 3.5 mm, 2-port ECal, 26.5 GHz	
N4692D 2.92 mm, 2-port ECal, 40 GHz		N4693D 2.4 mm, 2-port ECal, 50 GHz	
N4694D 1.85 mm, 2-port ECal, 67 GHz		X11644A WR-90 standard cal kit	
85033D/E 3.5 mm cal kit, 9 GHz		85052D 3.5 mm cal kit, 26.5 GHz	
85056D 2.4 mm cal kit, 50 GHz		N9910X-888 Hands free harness (for FieldFox N99xxB models only)	
N9910X-895 Magnetic mount base for antenna			

1. Discontinued

For more information on Keysight Technologies' products, applications, or services, please visit: [www.keysight.com](http://www.keysight.com)