

RIGOL

Quick Guide

DG1000Z Series Function/Arbitrary Waveform Generator

**Aug. 2016
RIGOL TECHNOLOGIES, INC.**

Guaranty and Declaration

Copyright

© 2013 **RIGOL** TECHNOLOGIES, INC. All Rights Reserved.

Trademark Information

RIGOL is a registered trademark of **RIGOL** TECHNOLOGIES, INC.

Publication Number

QGB09104-1110

Notices

- **RIGOL** products are covered by P.R.C. and foreign patents, issued and pending.
- **RIGOL** reserves the right to modify or change parts of or all the specifications and pricing policies at the company's sole decision.
- Information in this publication replaces all previously released materials.
- Information in this publication is subject to change without notice.
- **RIGOL** shall not be liable for either incidental or consequential losses in connection with the furnishing, use, or performance of this manual, as well as any information contained.
- Any part of this document is forbidden to be copied, photocopied, or rearranged without prior written approval of **RIGOL**.

Product Certification

RIGOL guarantees that this product conforms to the national and industrial standards in China as well as the ISO9001:2008 standard and the ISO14001:2004 standard. Other international standard conformance certifications are in progress.

Contact Us

If you have any problem or requirement when using our products or this manual, please contact **RIGOL**.

E-mail: service@rigol.com

Website: www.rigol.com

Safety Requirement

General Safety Summary

Please review the following safety precautions carefully before putting the instrument into operation so as to avoid any personal injury or damage to the instrument and any product connected to it. To prevent potential hazards, please follow the instructions specified in this manual to use the instrument properly.

Use Proper Power Cord.

Only the exclusive power cord designed for the instrument and authorized for use within the local country could be used.

Ground the Instrument.

The instrument is grounded through the Protective Earth lead of the power cord. To avoid electric shock, connect the earth terminal of the power cord to the Protective Earth terminal before connecting any input or output terminals.

Connect the Probe Correctly.

If a probe is used, do not connect the ground lead to high voltage since it has isobaric electric potential as the ground.

Observe All Terminal Ratings.

To avoid fire or shock hazard, observe all ratings and markers on the instrument and check your manual for more information about ratings before connecting the instrument.

Use Proper Overvoltage Protection.

Ensure that no overvoltage (such as that caused by a bolt of lightning) can reach the product. Otherwise, the operator might be exposed to the danger of an electric shock.

Do Not Operate Without Covers.

Do not operate the instrument with covers or panels removed.

Do Not Insert Anything Into the Air Outlet.

Do not insert anything into the air outlet to avoid damage to the instrument.

Use Proper Fuse.

Please use the specified fuses.

Avoid Circuit or Wire Exposure.

Do not touch exposed junctions and components when the unit is powered on.

Do Not Operate With Suspected Failures.

If you suspect that any damage may occur to the instrument, have it inspected by **RIGOL** authorized personnel before further operations. Any maintenance, adjustment or replacement especially to circuits or accessories must be performed by **RIGOL**

authorized personnel.

Provide Adequate Ventilation.

Inadequate ventilation may cause an increase of temperature in the instrument, which would cause damage to the instrument. So please keep the instrument well ventilated and inspect the air outlet and the fan regularly.

Do Not Operate in Wet Conditions.

To avoid short circuit inside the instrument or electric shock, never operate the instrument in a humid environment.

Do Not Operate in an Explosive Atmosphere.

To avoid personal injuries or damage to the instrument, never operate the instrument in an explosive atmosphere.

Keep Instrument Surfaces Clean and Dry.

To avoid dust or moisture from affecting the performance of the instrument, keep the surfaces of the instrument clean and dry.

Prevent Electrostatic Impact.

Operate the instrument in an electrostatic discharge protective environment to avoid damage induced by static discharges. Always ground both the internal and external conductors of cables to release static before making connections.

Use the Battery Properly.

Do not expose the battery (if available) to high temperature or fire. Keep it out of the reach of children. Improper change of a battery (lithium battery) may cause an explosion. Use the **RIGOL** specified battery only.

Handle with Caution.

Please handle with care during transportation to avoid damage to keys, knobs, interfaces, and other parts on the panels.

Safety Notices and Symbols

Safety Notices in this Manual:



WARNING

Indicates a potentially hazardous situation or practice which, if not avoided, will result in serious injury or death.



CAUTION

Indicates a potentially hazardous situation or practice which, if not avoided, could result in damage to the product or loss of important data.

Safety Terms on the Product:

DANGER It calls attention to an operation, if not correctly performed, could result in injury or hazard immediately.

WARNING It calls attention to an operation, if not correctly performed, could result in potential injury or hazard.

CAUTION It calls attention to an operation, if not correctly performed, could result in damage to the product or other devices connected to the product.

Safety Symbols on the Product:



Hazardous Voltage



Safety Warning



Protective Earth Terminal



Chassis Ground



Test Ground

Allgemeine Sicherheits Informationen

Überprüfen Sie die folgenden Sicherheitshinweise sorgfältig um Personenschäden oder Schäden am Gerät und an damit verbundenen weiteren Geräten zu vermeiden. Zur Vermeidung von Gefahren, nutzen Sie bitte das Gerät nur so, wie in diesem Handbuch angegeben.

Um Feuer oder Verletzungen zu vermeiden, verwenden Sie ein ordnungsgemäßes Netzkabel.

Verwenden Sie für dieses Gerät nur das für ihr Land zugelassene und genehmigte Netzkabel.

Erden des Gerätes.

Das Gerät ist durch den Schutzleiter im Netzkabel geerdet. Um Gefahren durch elektrischen Schlag zu vermeiden, ist es unerlässlich, die Erdung durchzuführen. Erst dann dürfen weitere Ein- oder Ausgänge verbunden werden.

Anschluss eines Tastkopfes.

Die Erdungsklemmen der Sonden sind auf dem gleichen Spannungspegel des Instruments geerdet. Schließen Sie die Erdungsklemmen an keine hohe Spannung an.

Beachten Sie alle Anschlüsse.

Zur Vermeidung von Feuer oder Stromschlag, beachten Sie alle Bemerkungen und Markierungen auf dem Instrument. Befolgen Sie die Bedienungsanleitung für weitere Informationen, bevor Sie weitere Anschlüsse an das Instrument legen.

Verwenden Sie einen geeigneten Überspannungsschutz.

Stellen Sie sicher, daß keinerlei Überspannung (wie z.B. durch Gewitter verursacht) das Gerät erreichen kann. Andernfalls besteht für den Anwender die Gefahr eines Stromschlages.

Nicht ohne Abdeckung einschalten.

Betreiben Sie das Gerät nicht mit entfernten Gehäuse-Abdeckungen.

Betreiben Sie das Gerät nicht geöffnet.

Der Betrieb mit offenen oder entfernten Gehäuseteilen ist nicht zulässig. Nichts in entsprechende Öffnungen stecken (Lüfter z.B.)

Passende Sicherung verwenden.

Setzen Sie nur die spezifikationsgemäßen Sicherungen ein.

Vermeiden Sie ungeschützte Verbindungen.

Berühren Sie keine unisolierten Verbindungen oder Baugruppen, während das Gerät in Betrieb ist.

Betreiben Sie das Gerät nicht im Fehlerfall.

Wenn Sie am Gerät einen Defekt vermuten, sorgen Sie dafür, bevor Sie das Gerät wieder

betreiben, dass eine Untersuchung durch **RIGOL** autorisiertem Personal durchgeführt wird. Jedwede Wartung, Einstellarbeiten oder Austausch von Teilen am Gerät, sowie am Zubehör dürfen nur von **RIGOL** autorisiertem Personal durchgeführt werden.

Belüftung sicherstellen.

Unzureichende Belüftung kann zu Temperaturanstiegen und somit zu thermischen Schäden am Gerät führen. Stellen Sie deswegen die Belüftung sicher und kontrollieren regelmäßig Lüfter und Belüftungsöffnungen.

Nicht in feuchter Umgebung betreiben.

Zur Vermeidung von Kurzschluß im Geräteinneren und Stromschlag betreiben Sie das Gerät bitte niemals in feuchter Umgebung.

Nicht in explosiver Atmosphäre betreiben.

Zur Vermeidung von Personen- und Sachschäden ist es unumgänglich, das Gerät ausschließlich fernab jedweder explosiven Atmosphäre zu betreiben.

Geräteoberflächen sauber und trocken halten.

Um den Einfluß von Staub und Feuchtigkeit aus der Luft auszuschließen, halten Sie bitte die Geräteoberflächen sauber und trocken.

Schutz gegen elektrostatische Entladung (ESD).

Sorgen Sie für eine elektrostatisch geschützte Umgebung, um somit Schäden und Funktionsstörungen durch ESD zu vermeiden. Erden Sie vor dem Anschluß immer Innen- und Außenleiter der Verbindungsleitung, um statische Aufladung zu entladen.

Die richtige Verwendung des Akku.

Wenn eine Batterie verwendet wird, vermeiden Sie hohe Temperaturen bzw. Feuer ausgesetzt werden. Bewahren Sie es außerhalb der Reichweite von Kindern auf. Unsachgemäße Änderung der Batterie (Anmerkung: Lithium-Batterie) kann zu einer Explosion führen. Verwenden Sie nur von **RIGOL** angegebenen Akkus.

Sicherer Transport.

Transportieren Sie das Gerät sorgfältig (Verpackung!), um Schäden an Bedienelementen, Anschlüssen und anderen Teilen zu vermeiden.

Sicherheits Begriffe und Symbole

Begriffe in diesem Guide:



WARNING

Die Kennzeichnung WARNING beschreibt Gefahrenquellen die leibliche Schäden oder den Tod von Personen zur Folge haben können.



CAUTION

Die Kennzeichnung Caution (Vorsicht) beschreibt Gefahrenquellen die Schäden am Gerät hervorrufen können.

Begriffe auf dem Produkt:

DANGER weist auf eine Verletzung oder Gefährdung hin, die sofort geschehen kann.

WARNING weist auf eine Verletzung oder Gefährdung hin, die möglicherweise nicht sofort geschehen.

CAUTION weist auf eine Verletzung oder Gefährdung hin und bedeutet, dass eine mögliche Beschädigung des Instruments oder anderer Gegenstände auftreten kann.

Symbole auf dem Produkt:



Gefährliche
Spannung



Sicherheits-
Hinweis



Schutz-erde



Gehäusemasse



Erde

Care and Cleaning

Care

Do not store or leave the instrument where it may be exposed to direct sunlight for long periods of time.

Cleaning

Clean the instrument regularly according to its operating conditions.

1. Disconnect the instrument from all power sources.
2. Clean the external surfaces of the instrument with a soft cloth dampened with mild detergent or water. When cleaning the LCD, take care to avoid scarifying it.



CAUTION

To avoid damage to the instrument, do not expose it to caustic liquids.



WARNING

To avoid short-circuit resulting from moisture or personal injuries, ensure that the instrument is completely dry before connecting it to the power supply.

Environmental Considerations

The following symbol indicates that this product complies with the WEEE Directive 2002/96/EC.



Product End-of-Life Handling

The equipment may contain substances that could be harmful to the environment or human health. To avoid the release of such substances into the environment and avoid harm to human health, we recommend you to recycle this product appropriately to ensure that most materials are reused or recycled properly. Please contact your local authorities for disposal or recycling information.

From: RIGOL Technologies Inc

Date: May 5, 2014

156# Cai He Village, Sha He Town, Chang Ping District, Beijing, China

<http://www.rigol.com>

Declaration of RoHS&WEEE Conformity

RoHS: The European Union of 2011/65/EU Restriction of Hazardous Substances (RoHS) Directive, which applies to all electrical products and their component parts, offered for sale into the European Union after July 22, 2014, restricts the presence of the six substances: Lead (Pb), Cadmium (Cd), Mercury (Hg), Hexavalent Chromium (Cr⁶⁺), Polybrominated biphenylethers (PBBs), and Polybrominated diphenylethers (PBDEs). In view of legal and market requirements, Rigol has restricted use of Pb, Cd, Hg, Cr⁶⁺, PBBs, PBDEs in our products. In addition, we require all our direct suppliers to strictly limit or prohibit use of hazardous substances. All its AVL (Approved Vendors List) components apply for RoHS.

Content of Compliance

Lead	<0.1% by weight (1000 ppm)	Mercury	<0.1% by weight (1000 ppm)
Cadmium	<0.01% by weight (100 ppm)	Hexavalent Chrome (Cr ⁶⁺)	<0.1% by weight (1000 ppm)
PBBs	<0.1% by weight (1000 ppm)	PBDEs	<0.1% by weight (1000 ppm)

WEEE: The European Union of 2012/19/EU, Waste Electrical and Electronic Equipment percentage of reused, recycled and recovered materials, such as metals, plastics, and components of waste electrical and electronic equipment.

We are registered in Germany in the WEEE (in Germany, EAR) register as a manufacturer of category 9 (monitoring and control) equipment and have the assigned registration number

WEEE-Reg.-No. : DE88132002

in our commercial documents.

RIGOL Technologies Inc

Weiming Mao

Director of Central Quality and

Environmental Management

Document Overview

Format Conventions in this Manual

1. **Button:**
The key at the front panel is denoted by the format of "Text Box + Button Name (Bold)" in the manual, for example, **Sine**.
2. **Menu:**
The menu is denoted by the format of "Character Shading + Menu Word (Bold)" in the manual, for example, **Freq**.
3. **Connector:**
The connector at the front or rear panel is denoted by the format of "Square Brackets + Connector Name (Bold) in the manual, for example, **[Counter]**.
4. **Operation Steps:**
The next step of the operation is denoted by an arrow "→" in the manual. For example, **Sine** → **Freq** denotes pressing **Sine** at the front panel and then pressing **Freq**.

Content Conventions in this Manual

1. DG1000Z series function/arbitrary waveform generator includes DG1022Z, DG1032Z and DG1062Z. In this manual, DG1062Z is taken as an example to illustrate the basic operations of the generator. For more details, please refer to DG1000Z Series Function/Arbitrary Waveform Generator User's Guide.

Model	Channels	Max. Frequency
DG1062Z	2	60MHz
DG1032Z	2	30MHz
DG1022Z	2	25MHz

2. All models of DG1000Z series function/arbitrary waveform generator are equipped with dual channels (CH1 and CH2). Unless otherwise specified, this manual takes CH1 as an example to introduce the operation method which is also applied to CH2.

Manuals of this Product

The manuals of this product mainly include the quick guide, user's guide, programming guide and data sheet. For the newest version of the desired manual, download it from www.rigol.com.

Content

Guaranty and Declaration	I
Safety Requirement.....	II
General Safety Summary	II
Safety Notices and Symbols	IV
Allgemeine Sicherheits Informationen	V
Sicherheits Begriffe und Symbole	VII
Care and Cleaning	VIII
Environmental Considerations	VIII
Document Overview	X
Quick Start.....	1
General Inspection	1
To Adjust the Handle	2
Appearance and Dimensions	3
Front Panel Overview.....	4
Rear Panel Overview.....	9
Power On and Inspection.....	11
To Connect to Power	11
Power-on Inspection.....	11
To Set the System Language.....	11
User Interface	12
Dual Channels Parameters Mode	12
Dual Channels Graph Mode	14
Single Channel Mode	14
To Use the Built-in Help System.....	15
Basic Operations.....	16
To Output Basic Waveform	16
To Output Arbitrary Waveform.....	17
To Output Harmonics.....	19
To Output AM Modulated Waveform	21
To Output FSK Modulated Waveform	22
To Output Sweep Waveform.....	23
To Output Burst Waveform.....	24
Remote Control	26
Troubleshooting	28

Quick Start

General Inspection

1. **Inspect the packaging**

If the packaging has been damaged, do not dispose the damaged packaging or cushioning materials until the shipment has been checked for completeness and has passed both electrical and mechanical tests.

The consigner or carrier shall be liable for the damage to the instrument resulting from shipment. **RIGOL** would not be responsible for free maintenance/rework or replacement of the instrument.

2. **Inspect the instrument**

In case of any mechanical damage, missing parts, or failure in passing the electrical and mechanical tests, contact your **RIGOL** sales representative.

3. **Check the accessories**

Please check the accessories according to the packing lists. If the accessories are damaged or incomplete, please contact your **RIGOL** sales representative.

To Adjust the Handle

To adjust the handle position of the instrument, please grip the handle by sides and pull it outward. Then, rotate the handle to the desired position. The operating method is shown below.

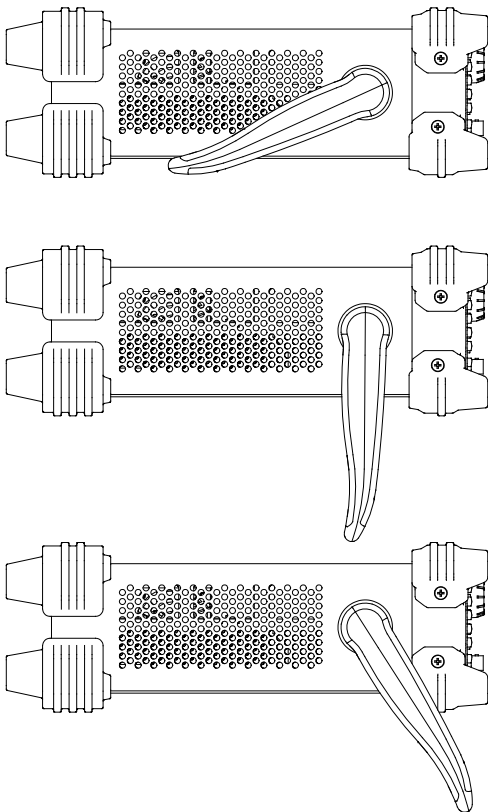
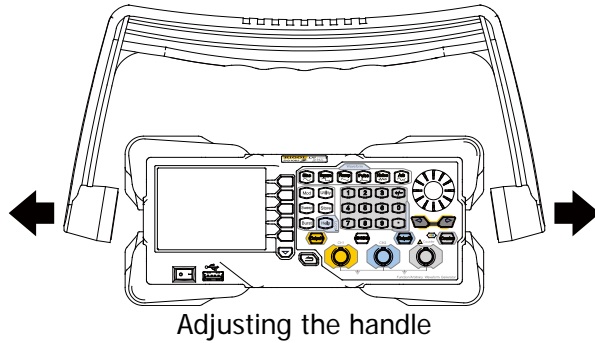

Viewing Positions

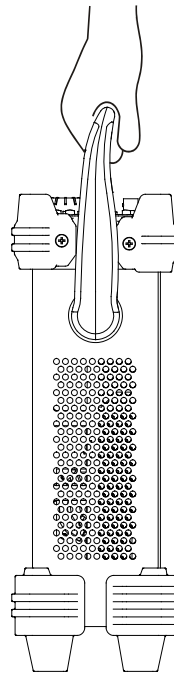

Carrying Position

Appearance and Dimensions

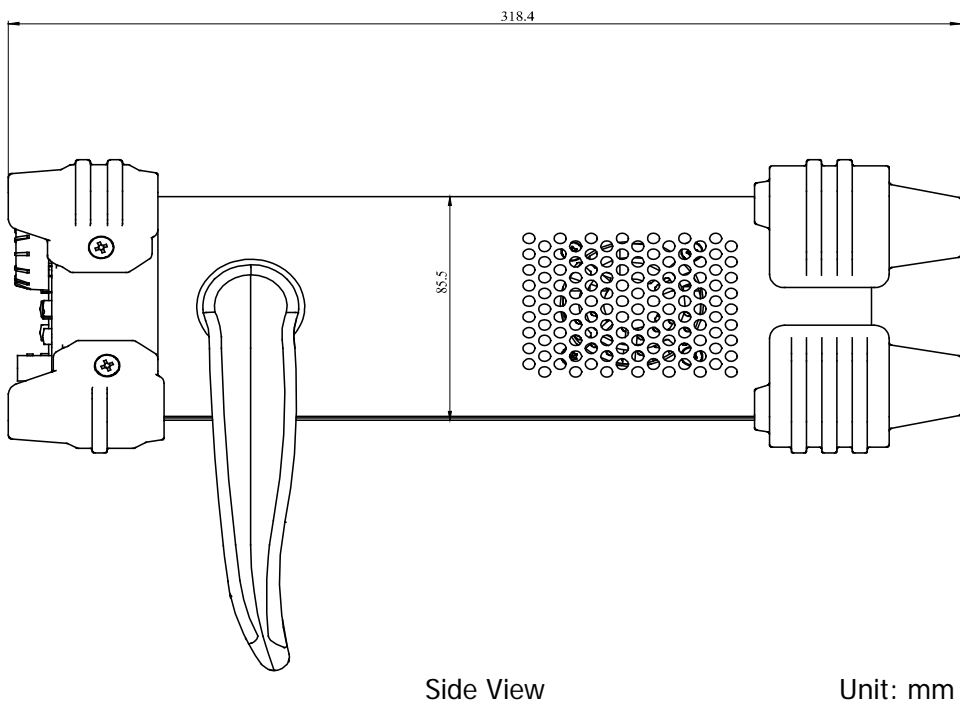
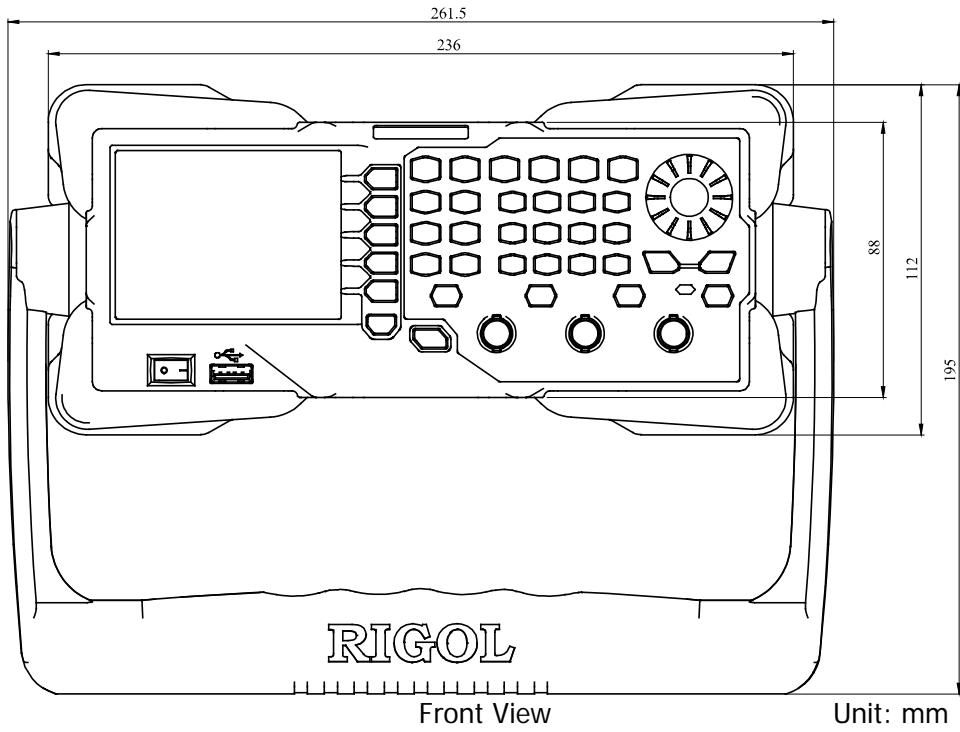

Front Panel Overview

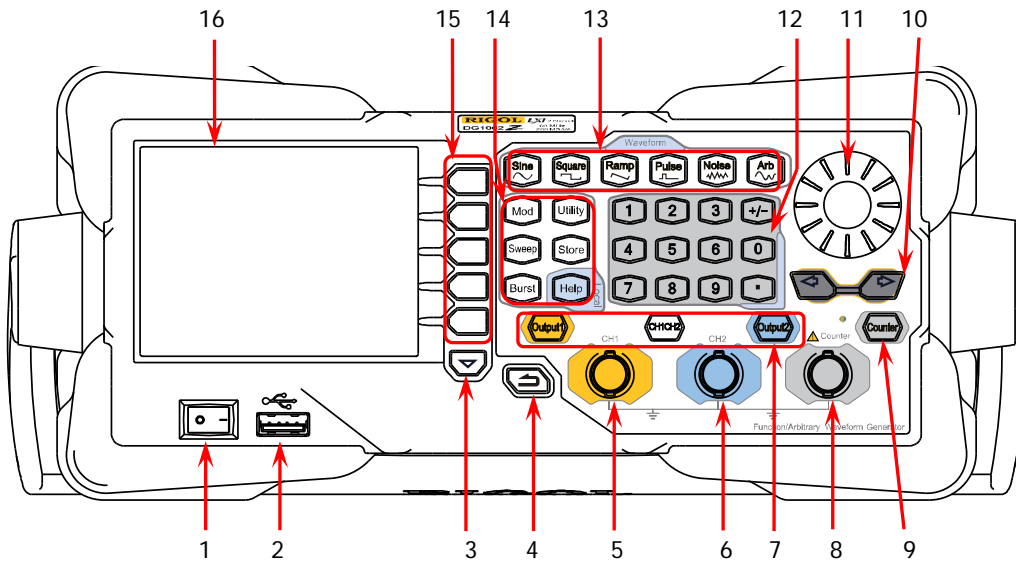

Figure 1 Front Panel

1. Power Key

The power key is used to turn the generator on or off.

2. USB Host

Support FAT32 format Flash type USB storage device, **RIGOL** TMC digital oscilloscope (DS), power amplifier (PA) (Option) and USB to GPIB interface converter (Option).

- USB storage device: read the waveform or state files saved in the USB storage device or store the current instrument states or edited waveform data into the USB storage device. In addition, the content displayed on the screen also can be saved as a picture file (*.Bmp) into the USB storage device.
- TMC DS: seamlessly interconnect with the **RIGOL** DS that meets the TMC standard. Read and store the waveform data collected by the DS and rebuilt waveform lossless.
- PA (Option): support the **RIGOL** power amplifier (such as PA1011). You can configure it online and the signal is outputted after whose power is amplified.
- USB to GPIB interface converter (Option): expand the GPIB interface for **RIGOL** instrument with USB Host interface but without GPIB interface.

3. Page Down

This key is used to open the next page of the current menu.

4. Return to the Previous Menu

Quit the current menu and return to the previous menu.

5. CH1 Output Connector

BNC connector. The nominal output impedance is 50Ω.

When the **Output1** is enabled (the backlight goes on), this connector outputs the waveform based on the current settings of CH1.

6. CH2 Output Connector

BNC connector. The nominal output impedance is 50Ω.

When the **Output2** is enabled (the backlight goes on), this connector outputs the waveform based on the current settings of CH2.

7. Channel Control Area



Used to control the output of CH1.

- Press this key to open the output of CH1, the backlight goes on and the **[CH1]** connector outputs the waveform based on the current settings of CH1.
- Press this key again to close the output of CH1 and the backlight goes off.



Used to control the output of CH2.

- Press this key to open the output of CH2, the backlight goes on and the **[CH2]** connector outputs the waveform based on the current settings of CH2.
- Press this key again to close the output of CH2 and the backlight goes off.

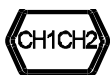

Used to switch the current selected channel between CH1 and CH2.



CAUTION

Overvoltage protection of CH1 and CH2 will take effect once any of the following conditions is met. When overvoltage protection takes effect, a message will be displayed and the output is disabled.

- The input voltage is higher than $\pm 11.5 \times (1 \pm 5\%)V$ ($< 10\text{kHz}$) when the amplitude of the generator is greater than 2Vpp or the DC offset is greater than $|2V_{DC}|$.
- The input voltage is higher than $\pm 3.5 \times (1 \pm 5\%)V$ ($< 10\text{kHz}$) when the amplitude of the generator is lower than or equal to 2Vpp or the DC offset is lower than or equal to $|2V_{DC}|$.

8. Input Connector for the Signal Measured by Counter

BNC connector. The input impedance is 1MΩ. This connector is used to accept the signal measured by the counter.

**Note**

To avoid damage to the instrument, the input signal voltage cannot exceed $\pm 7V_{ac+dc}$.

9. Counter

Used to turn the counter on or off.

- Press this key to turn the counter on, the backlight goes on and the indicator at the left of **Counter** blinks.
- Press this key again to turn the counter off and the backlight goes off.

Note: the sync signal of CH2 will be disabled if the counter is turned on and it will be enabled after the counter is turned off.

10. Direction Keys

- Used to move the cursor to select the digit to be edited when setting parameter using knob.
- Used to delete the number at the left of the cursor when inputting parameter using numeric keyboard.
- Used to unfold or fold the selected directory when storing or reading file.
- Used to move the cursor to select the desired character in filename input area when editing filename.

11. Knob

- Used to increase (clockwise) or decrease (counterclockwise) the value marked by the cursor when setting parameter using knob.
- Used to select the storage location when storing a file or used to select the file to be read when reading file.
- Used to select a character from the virtual keyboard when editing filename.
- Used to select a desired built-in arbitrary waveform from **Arb** → **Select Wform** → **BuiltIn**.

12. Numeric Keyboard

The numeric keyboard consists of number keys (0 to 9), decimal point (.) and sign key (+/-) and is used to set the parameters.

Note:

- The sign key is used to switch between uppercase and lowercase inputs.
- Press the decimal point twice to save the content displayed in the user interface in the USB storage device in *.Bmp format.

13. Waveform Keys

Output Sine with frequency from 1 μ Hz to 60MHz.

- The backlight goes on when this function is selected.
- You can set the parameters for sine waveform including Freq/Period, Ampl/HiLevel, Offset/LoLevel and Start Phase.



Output Square with frequency from 1 μ Hz to 25MHz and variable duty cycle.

- The backlight goes on when this function is selected.
- You can set the parameters for square waveform including Freq/Period, Ampl/HiLevel, Offset/LoLevel, Duty Cycle and Start Phase.



Output Ramp with frequency from 1 μ Hz to 1MHz and variable symmetry.

- The backlight goes on when this function is selected.
- You can set the parameters for ramp waveform including Freq/Period, Ampl/HiLevel, Offset/LoLevel, Symmetry and Start Phase.



Output Pulse with frequency from 1 μ Hz to 25MHz and variable pulse width and edge times.

- The backlight goes on when this function is selected.
- You can set the parameters for pulse including Freq/Period, Ampl/HiLevel, Offset/LoLevel, Width/Duty, Leading, Trailing and Start Phase.



Output Gaussian Noise with 60MHz bandwidth.

- The backlight goes on when this function is selected.
- You can set the parameters for Noise including Ampl/HiLevel and Offset/LoLevel.



Output Arbitrary waveform with frequency from 1 μ Hz to 20MHz.

- Support two output modes:
Sample Rate and **Frequency**.
- Up to 160 built-in waveforms.
- The backlight goes on when this function is selected.
- You can set the parameters for Arb waveform including Freq/Period, Ampl/HiLevel, Offset/LoLevel and Start Phase.

14. Function Keys



Output multiple types of modulated waveforms.

- Support multiple modulation types: AM, FM, PM, ASK, FSK, PSK and PWM.
- Support internal and external modulation sources.
- The backlight goes on when this function is selected.



Output Sweep waveform for Sine, Square, Ramp and Arb (except DC).

- 3 Sweep types: Linear, Log and Step.
- 3 types of trigger sources: Internal, External and Manual.
- Provide frequency mark function used to control the status of the sync signal.

- The backlight goes on when this function is selected.



Output Burst waveform for Sine, Square, Ramp, Pulse and Arb (except DC).

- 3 Burst types: NCycle, Infinite and Gated.
- Noise can also be used to generate gated burst waveform.
- 3 types of trigger sources: Internal, External and Manual.
- The backlight goes on when this function is selected.



Used to set the auxiliary function parameters and system parameters. The backlight goes on when this function is selected.



Store or recall the instrument state or the user-defined arbitrary waveform data.

- A nonvolatile memory (C disk) is built in and an USB storage device (D disk) can be connected.
- The backlight goes on when this function is selected.



To get the help information of any front panel key or menu softkey, press this key and then press the desired key.

Note:

- 1) When the instrument is working in remote mode, press this key to return to local mode.
- 2) Used to lock or unlock the keyboard. Press and hold **Help** to lock the front panel keys and at this point, the front panel keys (except **Help**) are not available. Press and hold this key again to unlock.

15. Menu Softkeys

Correspond to the menus at the left and pressing the softkey will activate the corresponding menu.

16. LCD

3.5 inches TFT (320×240) color LCD display. The current settings and state of the instrument can be clearly displayed. For detailed information, refer to “**User Interface**”.

Rear Panel Overview

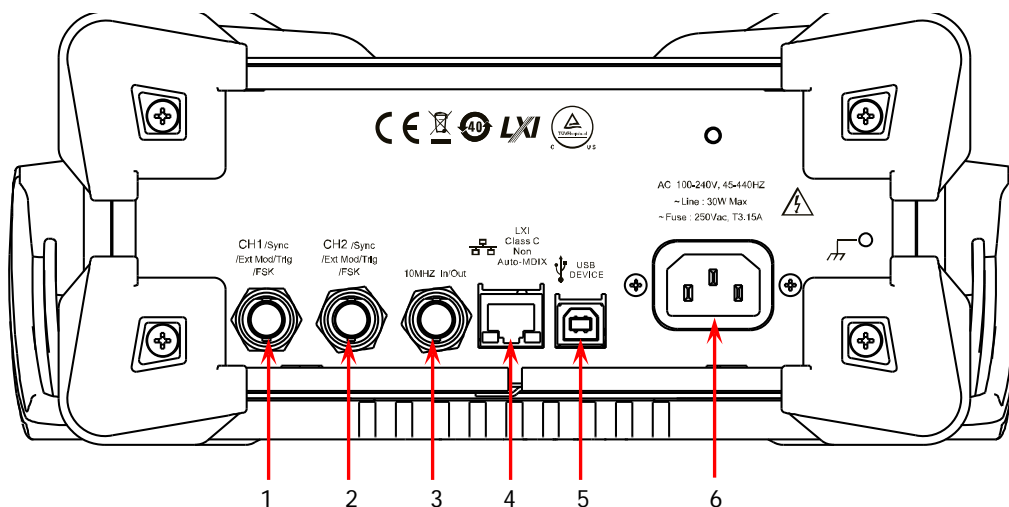

Figure 2 Rear Panel

1. [CH1/Sync/Ext Mod/Trig/FSK]

It is a BNC (female) connector which nominal impedance is 50Ω. The function of this connector is determined by the work mode of CH1.

- **Sync:** when the output of CH1 is enabled, this connector output the corresponding sync signal.
- **Ext Mod:** when AM, FM, PM or PWM of CH1 is enabled and external modulation source is selected, this connector accepts an external modulation signal.
- **FSK:** when ASK, FSK or PSK of CH1 is enabled and external modulation source is selected, this connector accepts an external modulation signal which polarity can be set by users.
- **Trig In:** when Sweep or Burst of CH1 is enabled and external trigger source is selected, this connector accepts an external trigger signal which polarity can be set by users.
- **Trig Out:** when Sweep or Burst of CH1 is enabled and internal or manual trigger source is selected, this connector outputs the trigger signal with specified edge type.

For more detailed information about the signals mentioned above, please refer to the User's Guide.

2. [CH2/Sync/Ext Mod/Trig/FSK]

It is a BNC (female) connector which nominal impedance is 50Ω. The function of this connector is determined by the work mode of CH2.

- **Sync:** when the output of CH2 is enabled, this connector output the corresponding sync signal.
- **Ext Mod:** when AM, FM, PM or PWM of CH2 is enabled and external

modulation source is selected, this connector accepts an external modulation signal.

- **FSK:** when ASK, FSK or PSK of CH2 is enabled and external modulation source is selected, this connector accepts an external modulation signal which polarity can be set by users.
- **Trig In:** when Sweep or Burst of CH2 is enabled and external trigger source is selected, this connector accepts an external trigger signal which polarity can be set by users.
- **Trig Out:** when Sweep or Burst of CH2 is enabled and internal or manual trigger source is selected, this connector outputs the trigger signal with specified edge type.

For more detailed information about the signals mentioned above, please refer to the User's Guide.

3. [10MHz In/Out]

It is a BNC (female) connector which nominal impedance is 50Ω. The function of this connector is determined by the type of the clock source.

- When internal clock source is selected, this connector (used as 10MHz Out) outputs the 10MHz clock signal generated by the internal crystal oscillator inside the generator.
- When external clock source is selected, this connector (used as 10MHz In) accepts an external 10MHz clock signal.

This connector is typically used to synchronize multiple generators. For more detailed information about the signals mentioned above, please refer to the User's Guide.

4. LAN Interface

Through this interface, the generator can be connected to your computer or the network of your computer for remote control. An integrated testing system may be built, as the generator conforms to the LXI Core 2011 Device class standard of LAN-based instrument control.

5. USB Device Interface

This interface is used to connect a computer which can control the generator remotely using PC software or by programming. It is also connected to a PictBridge printer to print the content displayed in the screen.

6. AC Power Socket

The AC power supply specification of this signal generator is 100-240V, 45-440Hz. The maximum input power of the instrument cannot exceed 30W. The specification of the fuse is 250V, T3.15A.

Power On and Inspection

To Connect to Power

Please connect the generator to AC power supply using the power cord supplied in the accessories as shown in the figure below. The AC power supply specification of this generator is 100-240V, 45-440Hz. The maximum input power of the instrument cannot exceed 30W. When the signal generator is connected to AC power supply via this connector, the instrument select the correct voltage range automatically and users do not need to select the voltage range manually.

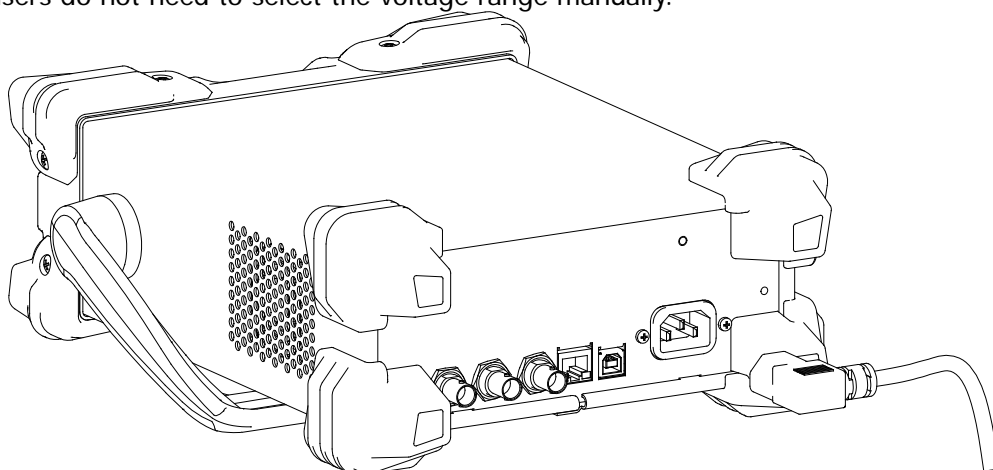



Figure 3 Connect to Power



CAUTION

To avoid electric shock, make sure that the instrument is correctly grounded.

Power-on Inspection

After the power supply is correctly connected, press the power key  at the front panel to turn on the generator. During the start-up, the instrument performs initialization and self-test. After that, the instrument enters the default interface. If the instrument does not start normally, please refer to the “**Troubleshooting**”.

To Set the System Language

DG1000Z series function/arbitrary generator supports multiple language menus. You can press **Utility** → **Language** to switch the desired language.

User Interface

The user interface of DG1000Z provides three types of display modes: **Dual Channels Parameters** (default), **Dual Channels Graph** and **Single Channel**. This manual mainly introduces the user interface taking the first display mode as an example.

Dual Channels Parameters Mode

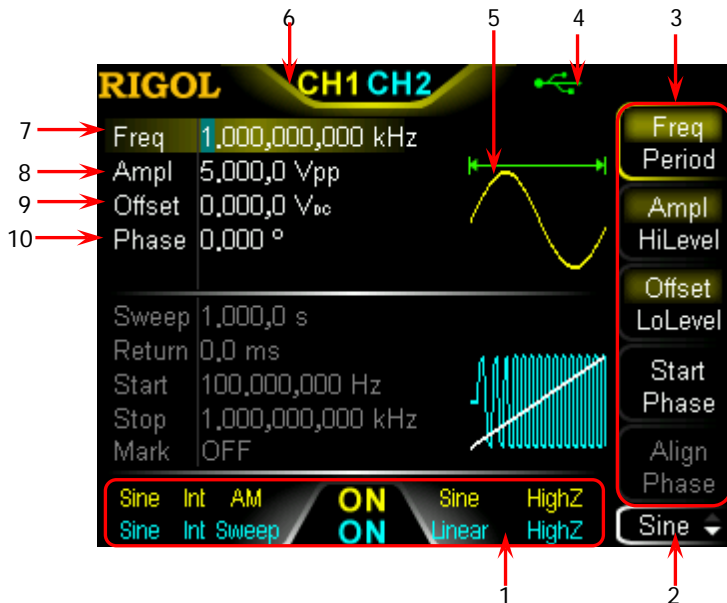

Figure 4 User Interface (Dual Channels Parameters Mode)

1. Channel Output Configuration Status Bar

Display the output configurations of the two channels.

Work Mode:
AM/FM/PM/ASK/FSK/PSK/
PWM/Sweep/Burst

Modulation Waveform of Analog Modulation:
Sine/Square/Tria/UpRamp/DnRamp/Noise/Arb
Polarity of Digital Modulation: Pos/Neg
Type of Sweep: Linear/Log/Step
Type of Burst: Ncycle/Infinite/Gated

Selected Waveform:
Sine
Squ
Ramp
Pulse
Noise
Arb
Harm

Type of Modulation Source: Int/Ext
Type of Sweep/Burst Trig Source: Int/Ext/Mu
Waveform Summing: Sum

Channel Output State:
ON/OFF

Type of Output Impedance:
High Impedance: display HighZ
Load: display impedance value (the default is 50Ω and the range is 1Ω to 10kΩ)



2. Current Function and Page Up/Down Indicator

Display the function name selected currently. For example, "Sine" is displayed when the sine is selected and "Edit" is displayed when the arbitrary waveform editing function is selected. Besides, the up and down arrows at the right of the function name are used to indicate whether page up/down is permitted now.

3. Menu

Display the operation menu of the function selected currently.

4. Status Bar



: displayed when the instrument is connected into LAN correctly.



: displayed when the instrument is in remote mode.



: displayed when the front panel of the instrument is locked.



: displayed when a USB storage device is detected.



: displayed when the instrument is connected with power amplifier correctly.

5. Waveform

Displayed the waveform currently selected by each channel.

6. Channel Status Bar

Used to indicating the selected status and on/off status of the channels. When CH1 is selected, the border of the bar is displayed in yellow. When CH2 is selected, the border of the bar is displayed in blue. When the output of CH1 is enabled, the "CH1" in the bar is highlighted in yellow. When the output of CH2 is enabled, the "CH2" in the bar is highlighted in blue.

Note: you can enable the outputs of the two channels but you cannot select the two channels at the same time.

7. Frequency

Display the waveform frequency of the channel. Press **Freq/Period** to highlight "Freq" and use the numeric keyboard or direction keys and knob to modify this parameter.

8. Amplitude

Display the waveform amplitude of the channel. Press **Ampl/HiLevel** to highlight "Ampl" and use the numeric keyboard or direction keys and knob to modify this parameter.

9. Offset

Display the waveform DC offset of the channel. Press **Offset/LoLevel** to highlight "Offset" and use the numeric keyboard or direction keys and knob to modify this parameter.

10. Phase

Display the waveform start phase of the channel. Press **Start Phase** and use the numeric keyboard or direction keys and knob to modify this parameter.

Dual Channels Graph Mode

Press **Utility** → **System** → **Display** → **DispMode** to select “Dual Graph”, as shown in the figure below.

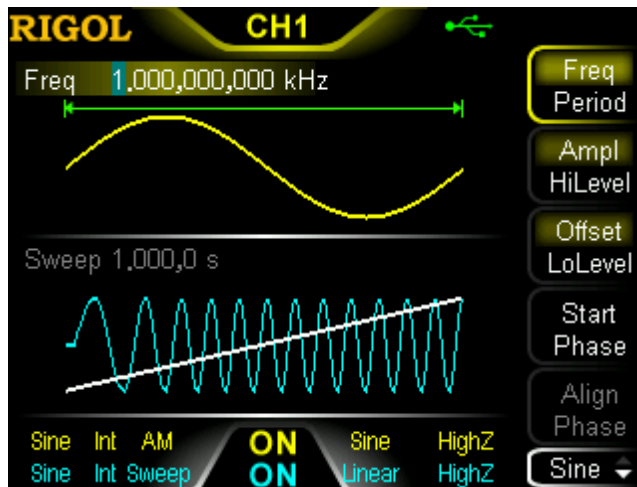

Figure 5 User Interface (Dual Channels Graph Mode)

Single Channel Mode

Press **Utility** → **System** → **Display** → **DispMode** to select “Single View”, as shown in the figure below.

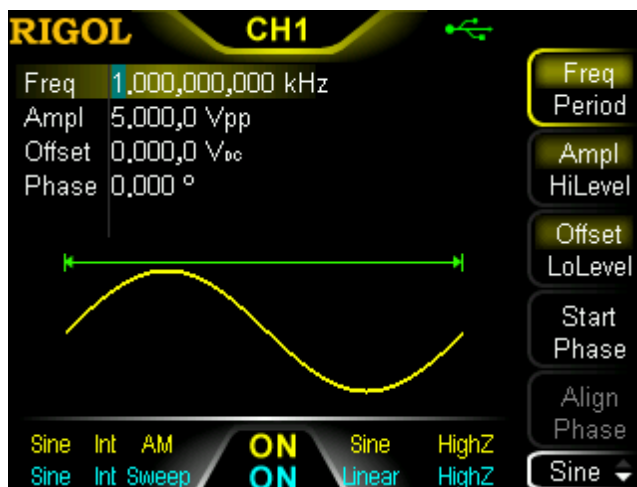

Figure 6 User Interface (Single Channel Mode)





To Use the Built-in Help System

The built-in help system of DG1000Z provides help information for each key and menu softkey at the front panel. Users can view the help of any key when operating the instrument.

1. Acquire the built-in help

Press **Help** and the backlight goes on. Then press the desired key or menu softkey and the corresponding help information is displayed.





2. Page up/down

When the help information is displayed on multiple pages, users can acquire the help information on the previous or next page using  (the previous line)/ (the next line)/ (page up)/ (page down) or the knob.

3. Turn off the current help information

When the help information is displayed in the interface, pressing  at the front panel will turn off the help information currently displayed.

4. Main Help Topics

Press **Help** twice to open the list of main help topics. Use /// or the knob to select the desired help topic and press **Select** to view the corresponding help information.

Basic Operations

To Output Basic Waveform

DG1000Z can output basic waveforms (Sine, Square, Ramp, Pulse and Noise) from one of the channels separately or from the two channels at the same time. This section introduces how to output a sine waveform (Frequency: 20kHz, Amplitude: 2.5Vpp, DC Offset: 500mV_{DC}, Start Phase: 90°) from the [CH1] connector.

1. To select output channel

Press **CH1 | CH2** to select CH1. Now the border of the channel status bar is displayed in yellow.

2. To select the Sine

Press **Sine** to select the sine waveform. The backlight goes on and the corresponding menu is displayed in the right of the screen.

3. To set the frequency/period

Press **Freq/Period** to highlight "Freq", and then use the numeric keyboard to input 20. Then select kHz from the pop-up menu.

- The frequency ranges from 1μHz to 60MHz.
- The frequency units available are MHz, kHz, Hz, mHz and μHz.
- Press this softkey again to switch to period setting.
- The period units available are sec, msec, μsec and nsec.

4. To set the amplitude

Press **Ampl/HiLevel** to highlight "Ampl", and use the numeric keyboard to input 2.5. Then, select Vpp from the pop-up menu.

- The amplitude range is limited by the impedance and frequency/period.
- The amplitude units available are Vpp, mVpp, Vrms, mVrms and dBm (dBm is only valid when the setting in **Utility** → **Channel Set** → **Output Set** → **Imped** is not HighZ).
- Press this softkey again to switch to high level setting.
- The high level units available are V and mV.

5. To set the offset

Press **Offset/LoLevel** to highlight "Offset", and then use the numeric keyboard to input 500. Then, select mV_{DC} from the pop-up menu.

- The range of the offset is limited by the impedance and frequency/period.
- The DC offset voltage units available are V_{DC} and mV_{DC}.
- Press this softkey again to switch to low level setting. The low level must be lower than the high level at least 1mV (when the output impedance is 50Ω).
- The low level units available are V and mV.

6. To set the start phase

Press **Start Phase**, and then use the numeric keyboard to input 90. Then, select ° from the pop-up menu. The start phase ranges from 0° to 360°.

7. To enable the output

Press **Output1** to turn CH1 output on. At this point, the backlight goes on and the **[CH1]** connector outputs waveform with the specified parameters.

8. To observe the output waveform

Connect the **[CH1]** connector to the oscilloscope using BNC cable. The waveform is as shown in the figure below.

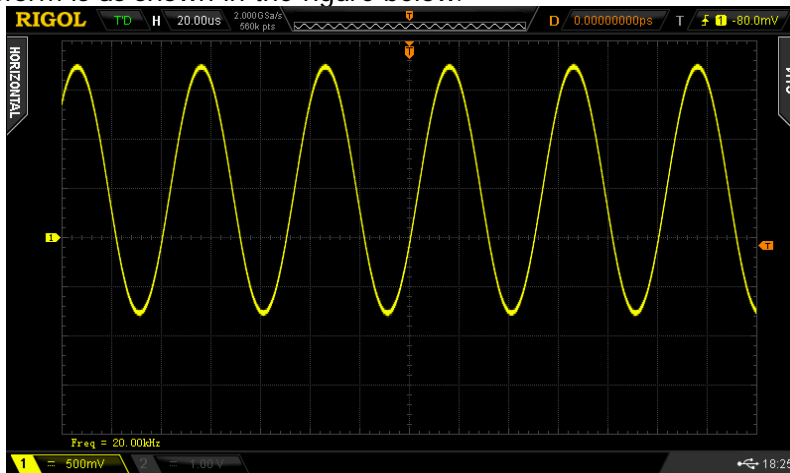

Figure 7 Sine

To Output Arbitrary Waveform

DG1000Z can output the built-in or user-defined arbitrary waveforms from a single channel or from two channels at the same time. This section introduces how to output an arbitrary waveform from the **[CH1]** connector (Edit Points, Sample Rate editing mode, HiLevel: 4V, LoLevel: -2V, Points: 8, Voltage of Point#1 to Point#4: 4V; Voltage of Point#5 to Point#8: -2V).

1. To select output channel

Press **CH1 | CH2** to select CH1. Now the border of the channel status bar is displayed in yellow.

2. To enable arbitrary waveform

Press **Arb** to enter the arbitrary waveform setting interface. Please set the frequency, amplitude, offset and start phase of the arbitrary waveform according to "To Output Basic Waveform".

3. To edit arbitrary waveform

Press **Arb** → **Edit Wform** to open the arbitrary waveform editing menu.

- 1) Press **Mode** to select "Sample Rate".
- 2) Press **HiLevel**, use the numeric keyboard to input 4 and select V from the pop-up menu.
- 3) Press **LoLevel**, use the numeric keyboard to input -2 and select V from the pop-up menu.
- 4) Press **Points**, use the numeric keyboard to input 8 and press **Sure**. At this point, a -2V level line appears.
- 5) Press **Edit Points** to enter the points editing interface.
 - Press **Edit Points** to define the first point. Press **Voltage**, use the numeric keyboard to input 4 and select V from the pop-up menu.
 - Press **Edit Points** again, use the numeric keyboard or knob to select point 2; then press **Voltage** to input 4V.
 - Define the voltage of point 3 to point 8 according to the method mentioned above.

4. To select waveform

Press **Arb** → **Select Wform** → **Volatile Wform** to select the waveform edited.

5. To enable the output

Press **Output1** to turn CH1 output on. At this point, the backlight goes on and the **[CH1]** connector outputs arbitrary waveform with the specified parameters.

6. To observe the output waveform

Connect the **[CH1]** connector to the oscilloscope using BNC cable. Now, you can observe the waveform via the oscilloscope.

To Output Harmonics

DG1000Z can be used as a harmonic generator to output harmonic with specified order, amplitude and phase. This section introduces how to output the 2nd and 4th harmonics from the [CH1] connector (Harmonic Amplitude: 2Vpp and 1Vpp, Phase: 30° and 50°, Order: 5).

1. To select output channel

Press **CH1 | CH2** to select CH1. Now the border of the channel status bar is displayed in yellow.

2. To set the parameters of the fundamental waveform

Set the frequency/period, amplitude/high level, offset/low level and start phase of the fundamental waveform according to "To Output Basic Waveform".

3. To enable the harmonic function

Press **Sine** → **Harm** to select "On". Press **Harmonic Para** to enter the harmonic setting menu.

4. To set harmonic order

Press **Order** in the harmonic setting menu, use the numeric keyboard to input 5 and press **Sure**.

- The range is limited by the maximum output frequency of the instrument as well as the fundamental waveform frequency.
- Range: integers within 2 to **maximum output frequency of the instrument ÷ fundamental waveform frequency**. The maximum is 8.

5. To select harmonic type

Press **Type** in the harmonic setting menu to select Even or User.

Method 1: Even

Press this key and the instrument would output fundamental waveform and even harmonics (the 2nd and 4th harmonics).

Method 2: User

Press this key and the instrument would output the user-defined orders of harmonics. The highest order is 8.

8 bits binary data is used to represent the output status of the 8 orders of harmonics respectively, wherein, 1 represents enabling the output of the corresponding harmonic and 0 represents disabling the output of the corresponding harmonic. Users only need to use the numeric keyboard to modify the value of each data bit (note: the leftmost bit representing fundamental waveform is always X and cannot be modified). For example, set the 8 bits data to X101 0000, thus 2nd and 4th orders of harmonics are output.

Note: the actual harmonics output is determined by the "Order" and "Type" currently specified.

6. To set harmonic amplitude

Press **Harmonic Ampl** in the harmonic setting menu to set the amplitude of the 2nd and 4th harmonics.

- 1) Press **SN**, use the numeric keyboard to input 2 and press **Sure**.
- 2) Press **Harmonic Ampl**, use the numeric keyboard to input 2 and select Vpp from the pop-up menu.
- 3) Set the amplitude of the 4th harmonic to 1Vpp according to 1) and 2).

7. To set harmonic phase

Press **Harmonic Phase** in the harmonic setting menu to set the phase of the 2nd and 4th harmonics.

- 1) Press **SN**, use the numeric keyboard to input 2 and press **Sure**.
- 2) Press **Harmonic Phase**, use the numeric keyboard to input 30 and select ° from the pop-up menu.
- 3) Set the phase of the 4th harmonic to 50° according to 1) and 2).

8. To enable the output

Press **Output1** to turn CH1 output on. At this point, the backlight goes on and the **[CH1]** connector outputs the fundamental waveform as well as the 2nd and 4th harmonics.

9. To observe the output waveform

Connect the **[CH1]** connector to the oscilloscope using BNC cable. The waveform is as shown in Figure 9.

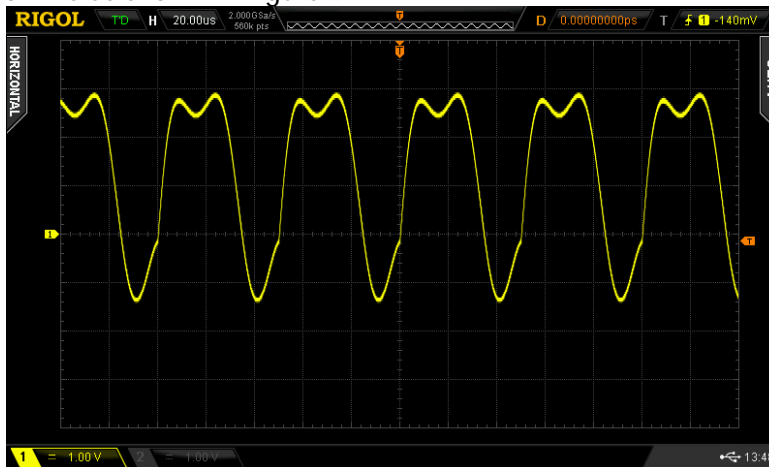

Figure 8 Harmonics

To Output AM Modulated Waveform

For amplitude modulation (AM), the amplitude of the carrier waveform varies with the instantaneous voltage of the modulating waveform. This section introduces how to output AM modulated waveform from the **[CH1]** connector (the carrier is sine with 5kHz frequency and 5Vpp amplitude, the modulating waveform is sine with 200Hz frequency and the modulation depth is 80%).

1. To select output channel

Press **CH1 | CH2** to select CH1. Now the border of the channel status bar is displayed in yellow.

2. To set the carrier waveform shape, frequency and amplitude

- 1) Carrier Waveform Shape: press **Sine** to select sine as the carrier waveform.
- 2) Carrier Frequency: press **Freq/Period** to highlight "Freq". At this point, use the numeric keyboard to input 5. Then, select kHz from the pop-up menu.
- 3) Carrier Amplitude: press **Ampl/HiLevel** to highlight "Ampl", and then use the numeric keyboard to input 5. Then, select Vpp from the pop-up menu.

3. To select AM modulation

Press **Mod** → **Type** → **AM** to enable AM function.

- When **Mod** is enabled, **Sweep** or **Burst** will be disabled automatically (if enabled currently).
- **Int** and **AM** will be displayed in the bottom of the screen.

4. To set Modulating waveform frequency

Press **AM Freq**, and then use the numeric keyboard to input 200. Then, select Hz from the pop-up menu.

5. To select modulating waveform

Press **Shape** to select Sine from the pop-up menu.

6. To set modulation depth

Press **AM Depth**, and then use the numeric keyboard to input 80. Then, select % from the pop-up menu.

7. To enable the output

Press **Output1** to turn CH1 output on. At this point, the backlight goes on and the **[CH1]** connector outputs the AM modulated waveform based on the current settings.

8. To observe the output waveform

Connect the **[CH1]** connector to the oscilloscope using BNC cable. The waveform is as shown in the figure below.

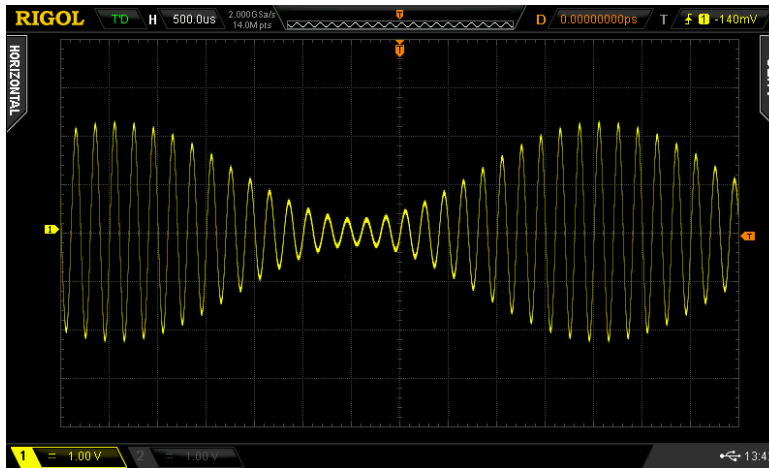

Figure 9 AM Modulated Waveform

To Output FSK Modulated Waveform

For FSK (Frequency Shift Keying) modulation, the generator “shifts” its output frequency between two preset frequencies (carrier frequency and hop frequency). This section introduces how to output FSK modulated waveform from the **[CH1]** connector (the carrier is sine with 3kHz frequency and 5Vpp amplitude, the hop frequency is 500Hz, the FSK rate is 100Hz and the modulating polarity is Pos).

1. To select output channel

Press **CH1 | CH2** to select CH1. Now the border of the channel status bar is displayed in yellow.

2. To set the carrier waveform shape, frequency and amplitude

- 1) Carrier Waveform Shape: press **Sine** to select sine as the carrier waveform.
- 2) Carrier Frequency: press **Freq/Period** to highlight “Freq”. At this point, use the numeric keyboard to input 3. Then, select kHz from the pop-up menu.
- 3) Carrier Amplitude: press **Ampl/HiLevel** to highlight “Ampl”, and then use the numeric keyboard to input 5. Then, select Vpp from the pop-up menu.

3. To select FSK modulation

Press **Mod** → **Type** → **FSK** to enable FSK function.

- When **Mod** is enabled, **Sweep** or **Burst** will be automatically disabled (if enabled currently).
- **Int** and **FSK** will be displayed in the bottom of the screen.

4. To set hop frequency

Press **Hop Freq**, use the numeric keyboard to input 500 and select Hz from the pop-up menu.

5. To set FSK rate

Press **FSK Rate**, use the numeric keyboard to input 100 and select Hz from the pop-up menu.

6. To set modulating polarity

Press **Polarity** to select the Pos polarity of the modulating waveform to control the output frequency. At this point, the generator would output the carrier frequency when the modulating waveform is logic low and output the hop frequency when the modulating waveform is logic high.

7. To enable the output

Press **Output1** to turn CH1 output on. At this point, the backlight goes on and the **[CH1]** connector outputs the FSK modulated waveform based on the current settings.

8. To observe the output waveform

Connect the **[CH1]** connector to the oscilloscope using BNC cable. Now, you can observe the waveform via the oscilloscope.

To Output Sweep Waveform

DG1000Z can output sweep waveform from a single channel or from dual channels at the same time. This section introduces how to output sweep waveform from the **[CH1]** connector (Linear sweep type, the carrier is sine with 5Vpp amplitude, the frequency range is 50Hz~1kHz, Sweep Time: 1s, Internal trigger source).

1. To select output channel

Press **CH1 | CH2** to select CH1. Now the border of the channel status bar is displayed in yellow.

2. To set the carrier waveform shape and amplitude for sweep

- 1) Waveform: Press **Sine** to select sine as the carrier waveform.
- 2) Amplitude: Press **Ampl/HiLevel** to highlight "Ampl", and then use the numeric keyboard to input 5. Then, select Vpp from the pop-up menu.

3. To enable sweep function

Press **Sweep** to enable the sweep function (the backlight of the key goes on).

- When **Sweep** is enabled, **Mod** or **Burst** function will be automatically disabled (if currently enabled).
- **Int** and **Sweep** will be displayed in the bottom of the screen.

4. To select sweep type

Press **Type** to select Linear. At this point, a white line appears on the waveform in the screen as shown in the right figure.



5. To set the start frequency and stop frequency

- 1) Start Frequency
Press **Start/Center** to highlight "Start", and then use the numeric keyboard to input "50". Then, select Hz from the pop-up menu.
- 2) Stop Frequency
Press **Stop/Span** to highlight "Stop", and then use the numeric keyboard to input 1. Then, select Hz from the pop-up menu.

6. To set the sweep time

Press **Sweep Time** to input 1 using the numeric keyboard and select sec from the pop-up menu.

7. To select the trigger source

Press **Trigger** → **Source** to select Int trigger source.

8. To enable the output

Press **Output1** to turn CH1 output on. At this point, the backlight goes on and the **[CH1]** connector outputs the sweep waveform based on the current settings.

9. To observe the output waveform

Connect the **[CH1]** connector to the oscilloscope using BNC cable. Now, you can observe the waveform via the oscilloscope.

To Output Burst Waveform

DG1000Z can output waveform with specified number of cycles (called burst) from a single channel or from dual channels at the same time. This section introduces how to output burst from the **[CH1]** connector (3 cycles, the carrier is sine with 5Vpp amplitude and 1ms period, Burst Period: 10ms, Internal trigger source, Delay: 1ms).

1. To select output channel

Press **CH1 | CH2** to select CH1. Now the border of the channel status bar is displayed in yellow.

2. To set the carrier waveform shape and amplitude for burst

- 1) Waveform: Press **Sine** to select sine as the carrier waveform.
- 2) Amplitude: Press **Ampl/HiLevel** to highlight "Ampl", and then use the numeric keyboard to input 5. Then, select Vpp from the pop-up menu.
- 3) Period: Press **Freq/Period** to highlight "Period", and then use the numeric keyboard to input 1. Then, select msec from the pop-up menu.

3. To enable burst function

Press **Burst** to enable the burst function (the backlight of the key goes on).

- When **Burst** is enabled, **Mod** or **Sweep** function will be automatically disabled (if currently enabled).
 - **Int** and **Burst** will be displayed in the bottom of the screen.
- To set the burst type and Cycles**
Press **Type** to select NCycle. At this point, the Cycles in the screen is highlighted and can be edited. Use the numeric keyboard to input 3 and press **Sure**.
 - To set burst period**
Burst period is only available for N cycle burst in internal trigger and is defined as the time from the start of a burst to the start of the next burst.
Press **Burst Period** to input 10 using the numeric keyboard and select msec from the pop-up menu.
 - To select burst trigger source**
Press **Trigger** → **Source** to select Int trigger source.
 - To set the delay**
Burst delay is only available for N cycle and infinite burst type. It is defined as the time from when the generator receives the trigger signal to starts to output the N Cycle (or Infinite) burst. Press **Delay**, and then use the numeric keyboard to input 1. Then select msec from the pop-up menu.
 - To enable the output**
Press **Output1** to turn CH1 output on. At this point, the backlight goes on and the **[CH1]** connector outputs the burst waveform based on the current settings.
 - To observe the output waveform**
Connect the **[CH1]** connector to the oscilloscope using BNC cable. The waveform is as shown in the figure below.

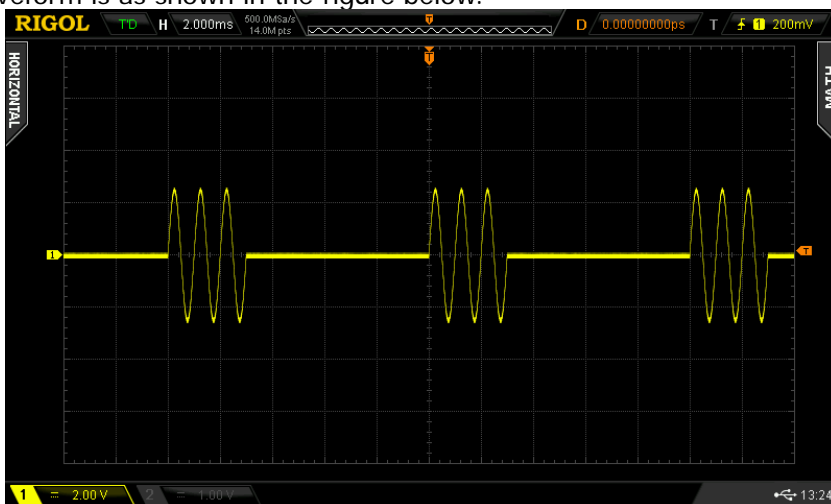



Figure 10 Burst

Remote Control

DG1000Z can communicate with PC through the USB, LAN or GPIB (option) interface to realize remote control on the basis of the SCPI commands (Standard Commands for Programmable Instruments). This section introduces how to control the generator remotely by sending the SCPI commands using **Ultra Sigma** provided by **RIGOL** via the USB interface. For detailed information about the commands, please refer to the Programming Guide.

When the instrument is working in remote mode, the  indicator is displayed in the screen and the keys (except **Help**) at the front panel are locked. Now you can return the instrument to local mode by pressing **Help**.

1. To install Ultra Sigma

Acquire the Ultra Sigma software and install it as well as its components according to the instructions. You can download the latest version of Ultra Sigma from **RIGOL** website.

2. To control the generator via USB

1) Connect the device

Connect the generator (USB Device) and PC (USB Host) using USB cable.

2) Install USB drive

This generator is USB-TMC device and the **New Hardware Wizard** will be displayed after the generator is correctly connected to the PC (the generator will be automatically configured to USB interface) and both of them are started. Please install the "USB Test and Measurement Device (IVI)" drive program according to the instructions.

3) Search for device resource

Start Ultra Sigma and the software will search for the generator resource currently connected to the PC automatically. You can also click

 to search for the resource manually.

4) View device resource

The resource found together with the instrument model and USB interface information will be displayed under the "RIGOL Online Resource" directory, as shown in Figure 12.



Figure 11 To View USB Instrument Resource

5) Communication test

Right-click the resource name DG1062Z

(USB0::0x1AB1::0x0642::DG1ZA000000000::INSTR) and select SCPI Panel Control to open the remote command control panel through which you can send commands and read data.

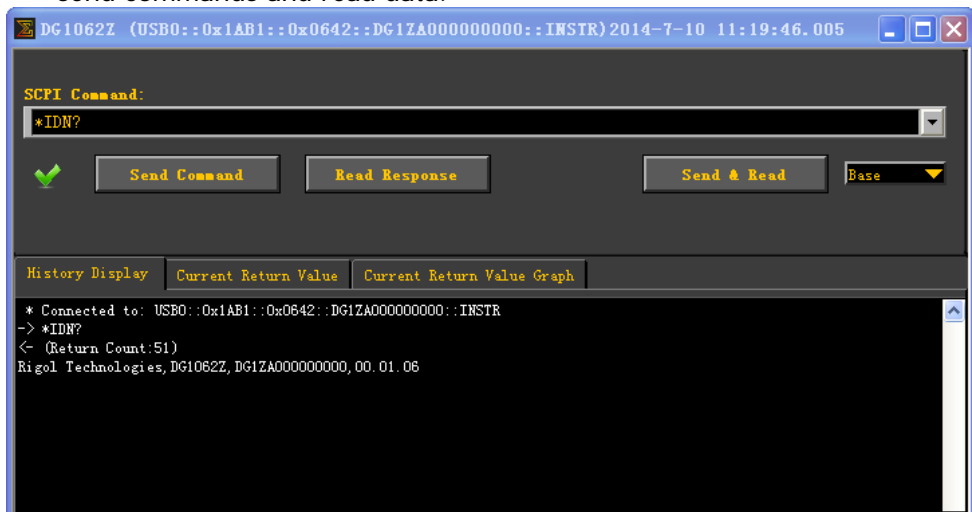



Figure 12 Send and Read Commands via USB

Troubleshooting

The commonly encountered failures and their solutions are listed below. When you encounter those problems, please solve them following the corresponding steps. If the problem remains still, please contact **RIGOL** and provide your device information (**Utility** → **System Info**).

- 1. The screen of the generator is still dark (no display) after pressing the power key:**
 - 1) Check whether the power is correctly connected.
 - 2) Check whether the power key is really pressed.
 - 3) Restart the instrument after finishing the above inspections.
 - 4) If it still does not work correctly, please contact **RIGOL**.
- 2. The screen is too dark and cannot be seen clearly:**
 - 1) Check whether the brightness setting of the LCD screen is too low.
 - 2) Press **Utility** → **System** → **Display** to enter the display setting menu. Press **Bright** and **Contrast** and use the numeric keyboard or the knob to adjust the brightness and contrast of the LCD screen to a proper value respectively.
- 3. The generator is locked:**
 - 1) Check whether the generator is in remote control mode (in remote control,  is displayed in the status bar of the user interface). Pressing **Help** can exit the remote control mode and unlock the front panel.
 - 2) Restarting the generator can also unlock the instrument.
- 4. The settings are correct but no waveform is generated:**
 - 1) Check if the BNC cable is tightly connected to the corresponding **[Output1]** or **[Output2]** connector.
 - 2) Check whether the connecting wire has internal damage.
 - 3) Check whether the BNC cable is tightly connected to the test instrument.
 - 4) Check whether the backlight of **Output1** or **Output2** goes on. If not, press corresponding key to illuminate the backlight.
 - 5) Press **Utility** → **System** → **Power On** to select Last and then restart the instrument after finishing the above inspections.
 - 6) If it does not work correctly, please contact **RIGOL**.
- 5. The USB storage device cannot be recognized:**
 - 1) Check whether the USB storage device can work normally when connected to other instrument or PC.
 - 2) Make sure that the USB storage device used is FAT32 format and Flash type. This instrument does not support hardware USB storage device.
 - 3) Restart the instrument and insert the USB storage again to check whether it can work normally.

- 4) If the USB storage device still cannot be used normally, please contact **RIGOL**.

6. How to set the amplitude of the waveform in dBm?

- 1) Press **CH1 | CH2** to select desired channel.
- 2) Check whether the setting in **Utility** → **Channel Set** → **Output Set** → **Imped** is HighZ. If yes, you cannot set the amplitude in dBm. Please press **Imped** to select Load and use the numeric keyboard or knob to set the impedance to a proper value.
- 3) Select desired waveform, press **Ampl/HiLevel** to highlight "Ampl", and then use the numeric keyboard to input desired value. Then select dBm from the pop-up menu.

7. Performance verification test is not passed:

- (1) Check whether the generator is within calibration period (1 year).
- (2) Make sure that the generator is warmed up for at least 30 minutes before test.
- (3) Check whether the generator is under the specified temperature.
- (4) Check whether the test is under the magnetic environment.
- (5) Check whether the power supplies of generator and test system have strong interference.
- (6) Check whether the performance of the test device meets the requirement.
- (7) Make sure that the test device is within calibration period.
- (8) Check whether the test device meets the required conditions of the manual.
- (9) Check whether all connections are tight.
- (10) Check whether all cables have internal damage.
- (11) Make sure that the operations conform to settings and processes which are required by the performance verification manual.
- (12) Check whether the error calculation is a mistake.
- (13) The definitions of "Typical Value" for this product should be correctly understood: the performance specification of this product under specified conditions.