

SINCE 1889



Forced Convection Constant Temperature Oven

Model: DKM300C/400C/600C
DKM310C/410C/610C

- First Edition -

- Thank you for purchasing "Forced Convection Constant Temperature Oven, DKMC Series" of Yamato Scientific Co., Ltd.
- To use this unit properly, read this "Instruction Manual" thoroughly before using this unit. Keep this instruction manual around this unit for referring at anytime.

⚠ WARNING!:

Carefully read and thoroughly understand the important warning items described in this manual before using this unit.

Yamato Scientific America Inc.

Table of Contents

1. Safety precautions.....	1
Explanation of pictograms.....	1
List of symbols.....	2
Warning · Cautions.....	3
2. Before operating the unit.....	4
Precautions when installing the unit.....	4
Installation procedures · precautions.....	7
3. Names and functions of parts.....	10
Main body.....	10
Operation panel.....	11
Explanation of characters.....	12
4. Operating procedures.....	13
List of operation modes and functions.....	13
Operation mode · function setting keys and characters.....	15
Operating procedures (settings for overheat prevention device).....	16
Operating procedures (fixed temperature operation).....	17
Operating procedures (quick auto stop operation).....	18
Operating procedures (auto stop operation).....	20
Operating procedures (auto start operation).....	22
Useful functions (calibration offset function).....	24
Useful function (setting lock function).....	25
Useful function (power outage compensation function).....	26
5. Cautions on handling.....	27
6. Maintenance procedures.....	30
Daily inspection/maintenance.....	30
7. When the unit is not to be used for a long time or when disposing.....	31
When the unit is not to be used for a long time or when disposing.....	31
Notes about disposition.....	31
8. Troubleshooting.....	32
Safety device and error codes.....	32
When a malfunction is suspected.....	33
9. After sales service and warranty.....	34
When requesting a repair.....	34
10. Specifications.....	35
11. Wiring diagram.....	36
12. List of replacement parts.....	36
13. List of dangerous materials.....	39
14. Standard installation manual.....	40

1. Safety precautions

Explanation of pictograms

About pictograms

A variety of pictograms are indicated in this operating instruction and on products to assure safe operation. Possible results from improper operation ignoring them are classified as follows.

Be sure to fully understand the descriptions below before proceeding to the text.



Warning

Indicates a situation which may result in death or serious injury (Note 1)



Caution

Indicates a situation which may result in minor injury (Note 2) and property damage (Note 3).

- (Note 1) Serious injury means a wound, an electrical shock, a bone fracture or intoxication that may leave after effects or require hospitalization or outpatient visits for a long time.
- (Note 2) Minor injury means a wound or an electrical shock that does not require hospitalization or outpatient visits for a long time.
- (Note 3) Property damage means damage to facilities, devices and buildings or other properties.

Meanings of pictograms



This pictogram indicates a matter that encourages the user to adhere to warning ("caution" included).
Specific description of warning is indicated near this pictogram.



This pictogram indicates prohibitions
Specific prohibition is indicated near this pictogram.



This pictogram indicates matters that the user must perform.
Specific instruction is indicated near this pictogram.

1. Safety precautions

List of symbols

Warning



General warnings



Danger!: High voltage



Danger!: High temperature



Danger!: Moving part

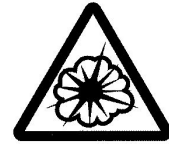

Danger!: Hazard of explosion

Caution



General cautions



Electrical shock!



Burning!



Caution for no liquid heating!



Caution for water leak!



For water only



Poisonous material

Prohibitions



General bans



Fire ban



Do not disassemble



Do not touch

Compulsions



General compulsions

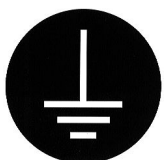

Connect ground wire



Install levelly

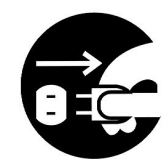

Pull out the power plug



Regular inspection

1. Safety precautions

Warning · Cautions

Warning



Never operate the unit in an atmosphere containing flammable or explosive gas

Never operate the unit in an atmosphere containing flammable or explosive gas. Otherwise, an explosion or a fire may result since the unit is not explosion-proof. See section "13. List of dangerous materials" on page 39.



Be sure to connect the ground wire.

Be sure to connect the ground wire correctly. Otherwise, electrical leak may result and cause an electrical shock or a fire.



Ban on operation when an abnormality occurs

When a smoke or a unusual odor is seen or sensed, immediately turn the ground fault interrupter on the main unit off and pull out the power plug. A fire or an electrical shock may result.



Never use electrical power cords bundled.

When these are used bundled, they might overheat causing a fire.



Take care not to damage electrical power cords.

Avoid tightly bend, pull with a strong force or twist to prevent electrical power cords from damaging. A fire or an electrical shock may result.



Never use an explosive or a flammable material with this unit.

Never use an explosive material, a flammable material or a material containing them. An explosion or an electrical shock may result. See section "13. List of dangerous materials" on page 39.



Never try to touch a hot part.

Some parts of the unit are hot during and immediately after operation. Take special care for possible burning.



Never try to disassemble or alter the unit.

Never try to disassemble or alter the unit. A malfunction, a fire or an electrical shock may result.



Caution



When a thunder is heard.

When a thunder is heard, turn the main power off immediately. A malfunction, fire or an electrical shock may result.

2. Before operating the unit

Precautions when installing the unit

1. Carefully select an installation site.



Take special care not to install the unit at a place described below:

- Uneven surfaces or dirty surfaces
- Where flammable gas or corrosive gas exists
- Where the ambient temperature is 35°C or more
- Where temperature changes severely
- Where humidity is high
- Where subject to direct sunlight
- Where vibration is severe



Secure minimum spaces as shown below around the unit.

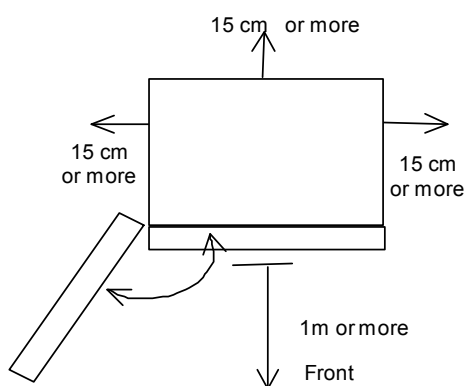

2. Install the unit on a level surface.



Install the unit on a level surface. If the whole bottom surface of the unit does not contact the surface evenly, vibrations or noises may result. This might cause unexpected troubles or malfunctions.

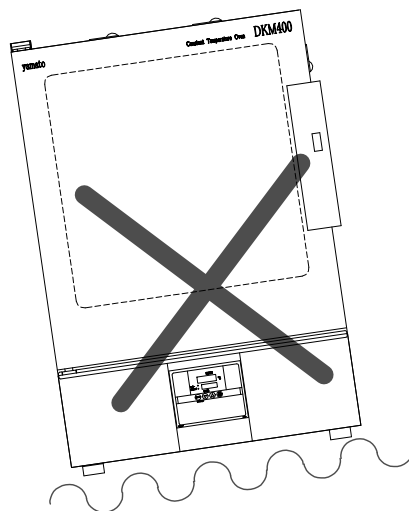

Weight of the unit are: Model DKM300C/310C: approx 35 kg; Model DKM400C/410C: approx 50 kg; Model DKM600C/610C: approx 65 kg. When lifting the unit for transportation and installation, carefully handle it by at least two people.

3. Installation



The unit might fall down or move by an earthquake or an impact resulting a personal injury. We recommend to make safety measures such as to avoid installing the unit at a place other than busy places.

2. Before operating the unit

Precautions when installing the unit

4. Assure sufficient ventilation for the unit.

- Do not operate the unit when its vent holes on the side and rear panels covered or blocked. Internal temperature of the unit will rise degrading the performance and an accident, a malfunction or a fire may result.

5. Do not operate the unit at such a place that may subject to splash.

- Do not operate the unit at such a place that may subject to splash. Liquid entering the inside may cause an accident, a malfunction, an electrical shock or a fire.

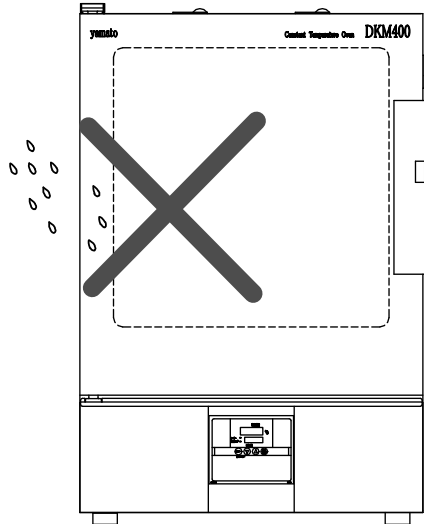

6. Never operate the unit in an atmosphere containing flammable or explosive gas.

- Never operate the unit in an atmosphere containing flammable or explosive gas. Since the unit is not explosion-proof, an arc is discharged when switching the circuit breaker interrupter "ON" and "OFF" and during operation and a fire or an explosion may result. See the section "13. List of dangerous materials" on page 39 for flammable and explosive gases.

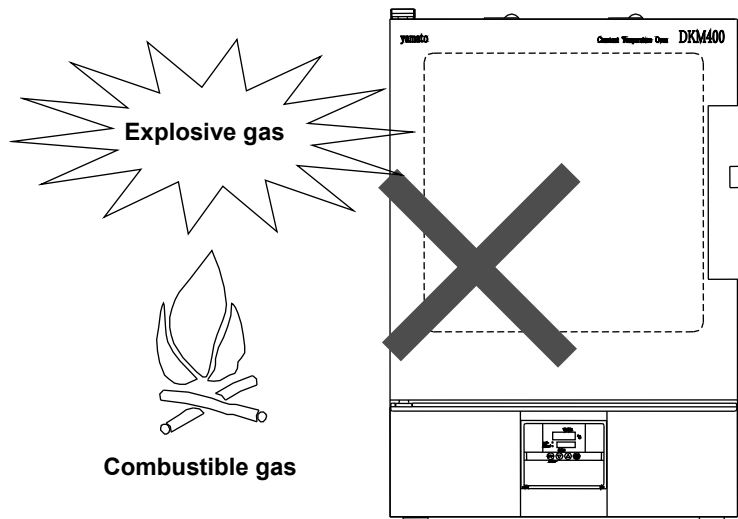

2. Before operating the unit

Precautions when installing the unit

7. Be sure to connect the power plug to the dedicated power distribution panel or a wall outlet.

- ! Choose a correct power distribution board or receptacle that meets the unit's rated electric capacity.

Electrical capacity:	DKM300C	AC115V	7.5A	DKM310C	AC220V	4.5A
	DKM400C	AC115V	11A	DKM410C	AC220V	6.5A
	DKM600C	AC115V	12A	DKM610C	AC220V	7A

NOTE:

There could be the case that the unit does not run even after turning ON the power. Inspect whether the voltage of the main power is lowered than the specified value, or whether other device(s) uses the same power line of this unit. If the phenomena might be found, change the power line of this unit to the other power line. Please consult your dealer or a local electrical contractor for the connection of devices that use a single-phase 220V power source.

- ! Do not connect the unit to any parts or lines other than a correct power supply line such as a gas pipe, a water pipe or a telephone line. Otherwise, an accident or a malfunction may result.

8. Handling of a power cord

- ⊘ Never use electrical power cords bundled. When these are used bundled, they might overheat causing a fire.
Never alter, forcibly bend, twist or pull the power cord. Otherwise, a fire or an electrical shock may result.
Do not put the power cord under a desk, a chair or between some objects to avoid damaging it. Otherwise, a fire or an electrical shock may result.
Do not place the power cord close to a stove or other heat generating device.
Sheath of the cord may burn and result in a fire or an electrical shock.
- ! If the power cord should be damaged (exposure of core wire or disconnection), immediately turn the MCB on the main body, turn the source power off and ask your dealer to replace the cord. Operating the unit with a damaged power cord may cause a fire or an electrical shock.
- ! Be sure to connect the power cord to a correct wall outlet.

2. Before operating the unit

Installation procedures • precautions

- (1) Select an installation site.
 - Make sure that all of four legs are securely on a flat surface.
- (2) Install shelf boards.
 - The lowest shelf board has been secured with screws at the time of shipping from the factory.

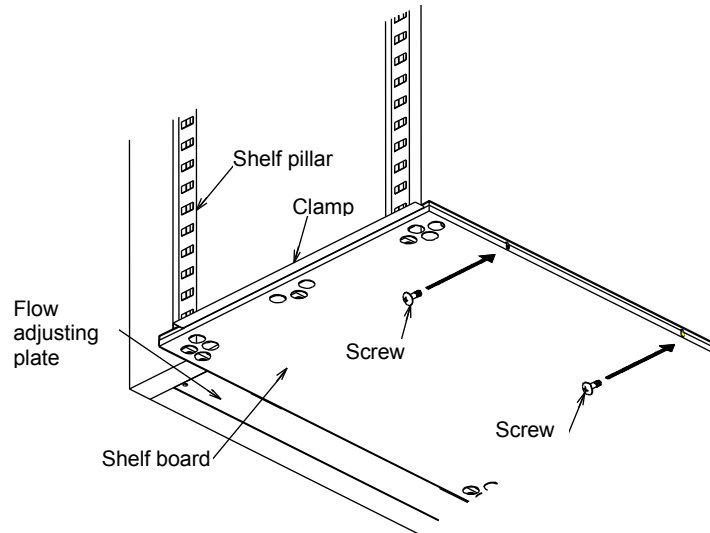

- Install shelf pegs at heights you want on the right and left shelf posts in the internal bath of the main body.
- Completely push shelf boards by sliding to the end.
 - *Take care to put each shelf board on correct pairs of right and left shelf pegs.
- Make sure that shelf boards will not fall nor rattle.
- Withstand load of each shelf board is 15 kg in even loading. When putting samples, arrange them as dispersed as possible.

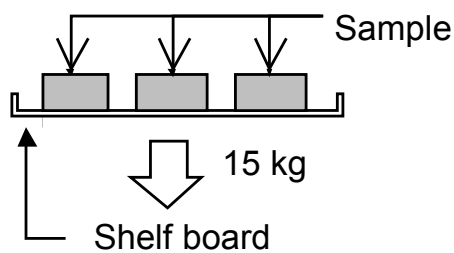

2. Before operating the unit

Installation procedures • precautions

- Put samples with spaces between them. Too many samples may prevent proper temperature control. To assure proper temperature control, put samples with a space at least 30% of the shelf board area.

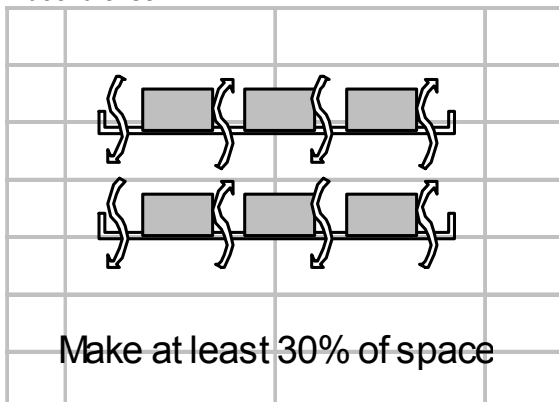

- Do not put a sample on the bottom of the internal bath.
 - Operating the unit with a sample directly put on the bottom of the internal bath might degrade its temperature characteristics. This also may cause corrosion, damage or rust of the internal bath. Never put any sample on the bottom surface.
 - When putting samples, take care not to allow them touching the wall, where sensor or other devices are installed. Put samples on the shelf board included with the unit.
- Take special care for samples shown below:
 - Samples that contain flammable or explosive components
 - The unit is not explosion proof. Never attempt to dry or process materials that contain flammable or explosive components.
 - Corrosive samples
 - Take care for handling of corrosive samples. Although SUS304 stainless steel is used for major components, note that they might corrode with strong acid. Note that packing may corrode with acid, alkali, oil or organic solvents.
- Always operate the unit with the vent holes open.
 - There are two vent holes on the top surface of the unit. In regular operation, open both of two vent holes. Adjust their opening level according to the water amount contained in a specific sample.



Note that high temperature steam may be blowing out of the vent holes.

To prevent a burn, never try to look into the vent holes or touch those parts with bare hands.

- Always shut the door completely.
 - Make sure that the clamp on the right side of the door is completely locked before operating the unit.

2. Before operating the unit

Installation procedures • precautions

- (7) About two-tier stacking
 - Use the dedicated optional parts to stack units in two tiers. Contact your dealer or the nearest sales office for the dedicated optional part.

- (8) Before using the unit for the first time
 - When you operate the unit for the first time at a higher temperature, the unit may generate an odor. This is due to decomposed bonding material contained in heat-insulation material and is not a malfunction of the unit. We recommend operating the unit at the highest temperature once before starting its regular operation.

3. Names and functions of parts

Main body

DKM300C/400C/600C/310C/410C/610C Front panel

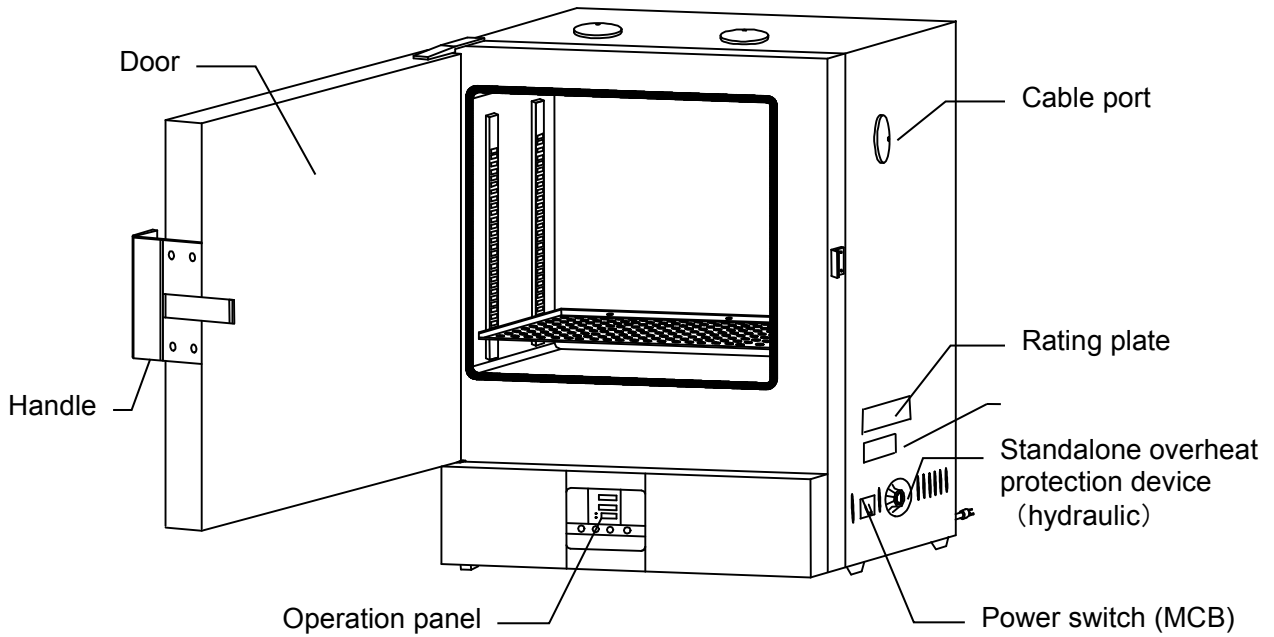

Rear panel

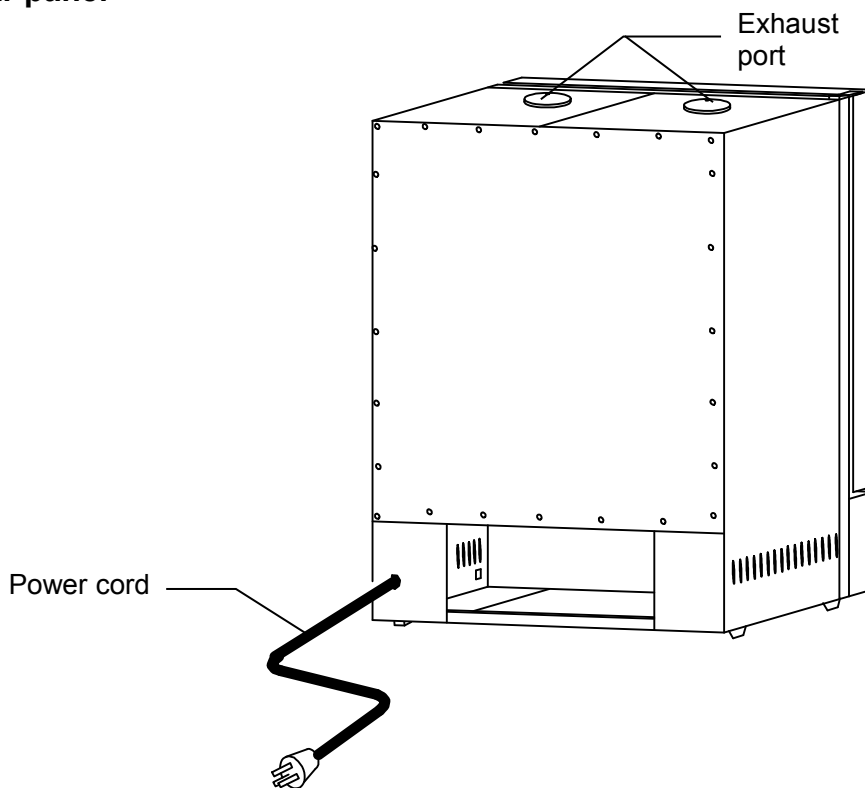

3. Names and functions of parts

Operation panel

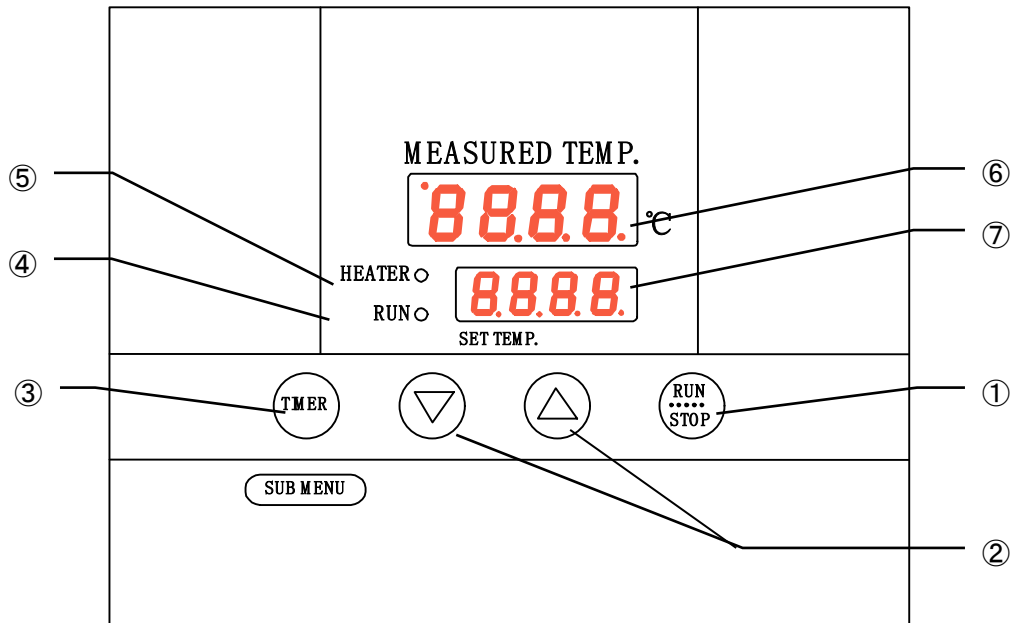







No.	Name	Operation/action
①	RUN/STOP key	Used for starting/stopping operation.
②	▼▲ key	Used for selecting settings.
③	TIMER key	Key for selecting timer operation settings. Quick auto stop operation, auto stop operation or auto start operation can be selected.
	SUB MENU key (Long press of the TIMER key)	Key for setting calibration offset temperature, the key lock function or the power outage compensation function.
④	RUN lamp	Illuminates during fixed temperature operation and blinks during timer operation.
⑤	HEATER lamp	Illuminates while heater power is on.
⑥	MEASURED TEMP. screen	Displays measured temperature in the bath/set characters/ alarm information.
⑦	SET TEMP. screen	Displays a set temperature, timer settings and timer remaining time.

3. Names and functions of parts

Explanation of characters

Characters on the controller are explained in this section.

Characters	Identifier	Name	Application
	AStP	Auto stop setting	Used for setting auto stop operation
	AStr	Auto start setting	Used for setting auto start operation
	End	Time up	Displayed when timer operation has ended. See page 18 and 20.
	cAL	Calibration offset setting	Used for inputting a calibration offset temperature. See section "Using the calibration offset function" on page 24.
	Lock	Key lock of settings	Key locks settings to prevent their alteration. See section "Using the lock function" on page 25.
	Pon	Power outage compensation setting	Used for setting auto start operation. See section "Using the power outage compensation function" on page 26.

* See the section "Operation mode · function setting keys and characters" on page 15 for characters of operation modes and functions.

4. Operating procedures

List of operation modes and functions

Operation modes of the unit are as shown below:

No.	Name	Description	Page
1	Fixed temperature operation	Turning the MCB on to enter the operation setting mode. Proceed to temperature setting that uses ▼▲ keys. Pressing the RUN/STOP key longer starts operation, and pressing the RUN/STOP key longer again stops operation.	P.17
2	Quick auto stop operation	Used when you want to “stop fixed temperature operation being performed automatically in several hours.” Press the TIMER key during fixed temperature operation to display “AStP.” Set a duration before stop with the ▼▲ keys. Pressing the RUN/STOP key starts quick auto stop operation and activates the timer in the middle of it to automatically stop it after the set period of time.	P.18
3	Auto stop operation	Used when you want to “set automatic stop for fixed temperature operation when making settings for it.” Press the TIMER key to display “AStP.” Set a duration before stop with the ▼▲ keys. Pressing the RUN/STOP key starts auto stop operation.	P.20
4	Auto start operation	Used when you want to “start operation automatically after several hours” after power is turned on. Press the TIMER key to display “AStr.” Set a duration before stop with the ▼▲ keys. Pressing the RUN/STOP key starts auto start operation.	P.22
* Operation mode cannot be changed while the unit is in operation. First stop operation before changing the mode.			

4. Operating procedures

List of operation modes and functions

Functions of the unit are as shown below:

No.	Name	Description	Page
1	Overheat prevention function	<p>Automatic overheat prevention function :</p> <p>This function is linked to the unit set temperature and has been set to so that it is automatically activated (returned automatically) at a temperature 12°C higher than the set temperature in the bath.</p> <p>Standalone overheat prevention device:</p> <p>When the temperature in the bath reaches the set temperature of the overheat prevention device, its heater circuit trips to shut off controller operation.</p> <p>The temperature can be set with the manual dial on the hydraulic overheat prevention device installed at the right side of the unit.</p>	P.16
2	Calibration offset function	<p>Calibration offset function compensates any differences between the target temperature in the bath and the control temperature of the controller (sensor temperature.)</p> <p>The function can compensate to either plus or minus side for the whole temperature band of the unit.</p> <p>This compensation can be set with the SUB MENU keys.</p>	P.24
3	Setting lock function	<p>This function locks the set operation status.</p> <p>The lock can be set or released with the SUB MENU keys.</p>	P.25
4	Power outage compensation function	<p>This function returns the main unit operation to the resume status after recovery from power outage, or keeps the current stop status.</p> <p>This compensation can be set with the SUB MENU keys.</p>	P.26

4. Operating procedures

Operation mode - function setting keys and characters

Key operations and characters in the diagram below are used for operation mode and function settings.

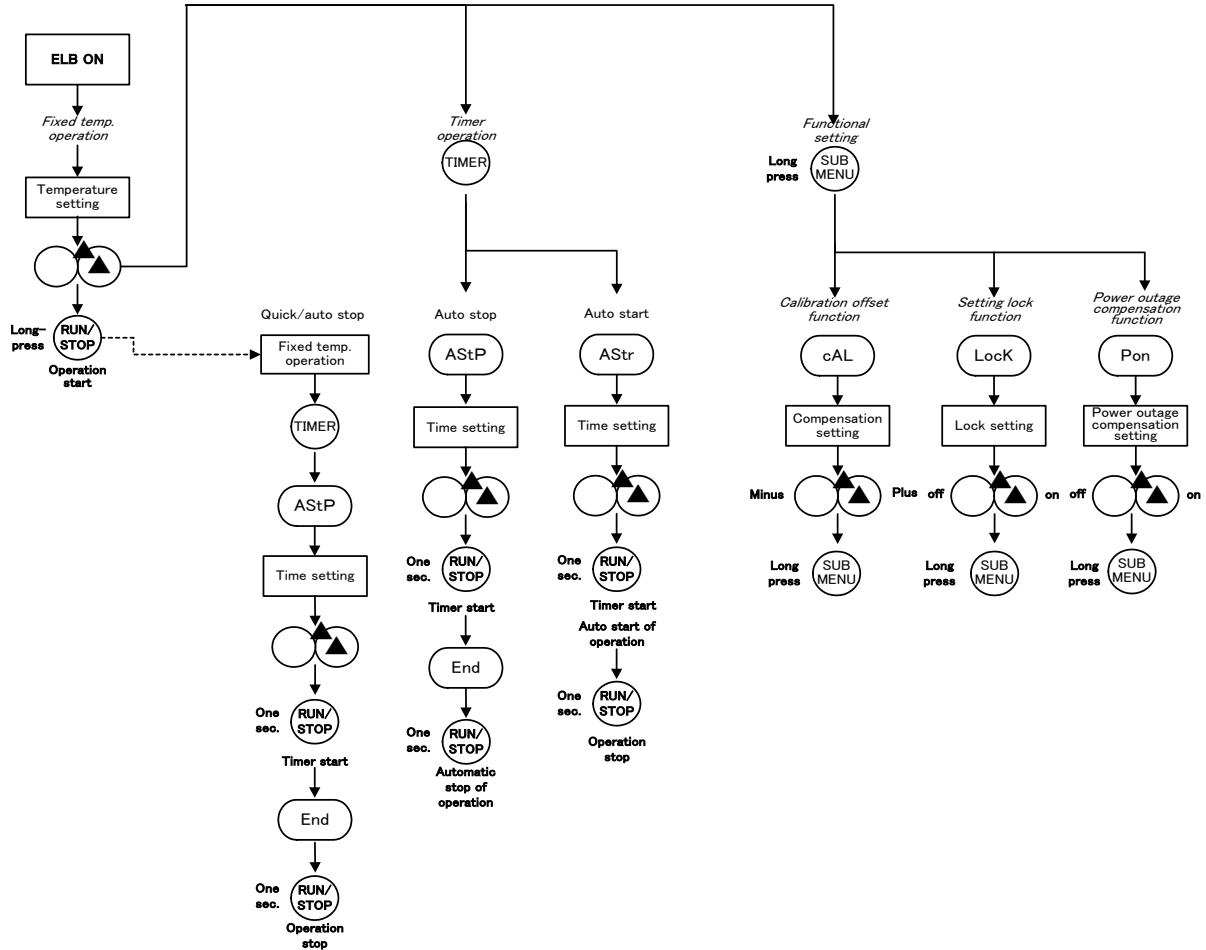

4. Operating procedures

Operating procedures (settings for overheat prevention device)

As a safety measure for preventing overheat, a hydraulic overheat prevention device (manual return) is installed.

Temperature setting range and functions

The temperature setting range for the standalone overheat prevention device is “50°C~320°C.”

When the temperature in the bath keeps rising beyond the controller set temperature and reaches the set temperature of the overheat prevention device, the heater circuit trips and the controller operation is shut off.

When the overheat prevention device is activated, it will not be released until the MCB is turned on.

How to set temperature

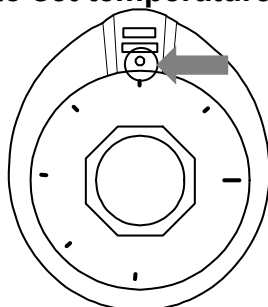

Set the temperature scale to the arrow

Setting the overheat prevention temperature

- Set the temperature scale on the hydraulic overheat prevention device installed on the right side of the unit to the arrow in the diagram shown left.
- Turn the MCB to “OFF” and wait for a while without opening the door.
- After a while, turn the MCB “ON.” (Turn the MCB “ON”.)

Caution

- ① Set temperature as “set temperature +20°C” as a rough standard and add 5°C to the setting if the device functions improperly.
- ② The temperature setting range for the standalone overheat prevention device is “50 °C ~ 320°C.” Be sure to set the overheat prevention activation temperature correctly otherwise the device may not start, the overheat prevention device is activated before temperature in the bath increases completely, or a fire or other unexpected accidents may result.
The temperature is set at 320°C on shipping from the factory.
- ③ If the temperature for the standalone overheat prevention device is set at around or below the room temperature, the device may be triggered when the door is opened.
- ④ The overheat prevention device has been designed to prevent overheating of devices not to protect samples. The device does not prevent accidents caused from use of explosive or flammable materials.

4. Operating procedures

Operating procedures (fixed temperature operation)

How to start fixed temperature operation

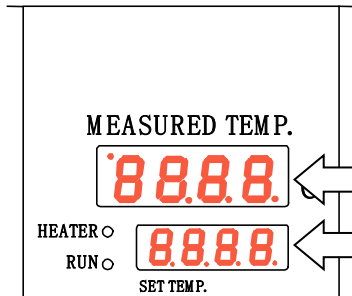

1. Turn the MCB ON. (Turn the MCB to “ON.”)

When the MCB is turned ON, the initial values will be displayed for about four seconds, then the initial screen will appear and the current bath temperature and the previous set temperature are displayed on each of the indicators.

Measured temperature screen: Displays the current bath temperature

Set temperature screen: Displays the previous set temperature

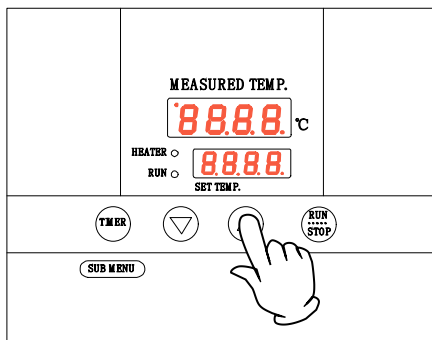

2. Setting the temperature

Set a temperature using the ▼▲ keys.

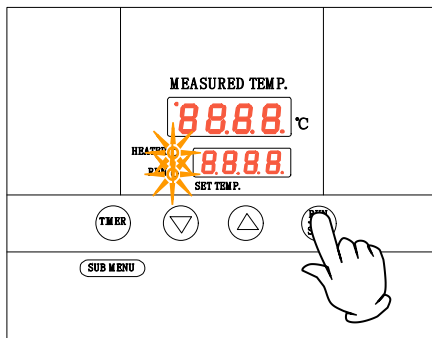

3. Starting operation

Press the **RUN/STOP** key longer.

Fixed temperature operation will start and the RUN lamp and the HEATER lamp come on.

4. Stopping operation

Press the **RUN/STOP** key longer.

Operation stops, the RUN lamp goes off and the screen switches to the initial setting screen.

When you want to correct setting errors or change settings

When you want to change settings, press the ▼▲ keys on the current screen to enter the setting mode where you can change settings. Blink stops three seconds after three seconds after change and setting is completed.



Caution

- ① When you want to lower the set temperature during fixed temperature operation, note that it takes some time to reach the reset temperature since the unit has no cooling capacity.
- ② Immediately after operation has been stopped, the temperature in the bath is around the set temperature. Operation stop refers only to machine stop and time needed for decreasing the temperature in the bath is not considered.

4. Operating procedures

Operating procedures (quick auto stop operation)

Used when you want to “stop fixed temperature operation being performed automatically in several hours. Quick auto stop operation is a function to enable auto stop timer setting during operation.

Procedures for quick auto stop operation

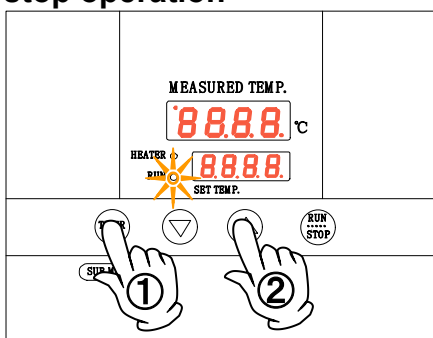

1. Setting time period before stop during fixed temperature operation

① Make sure that the RUN lamp is illuminated to indicate the unit is in operation. Press the **TIMER** key.

Characters **ASTP** **ASTP** are indicated on the MEASURED TEMP. screen to indicate the auto stop operation mode and set duration blinks on the SET TEMP. screen.

② Set a duration you want using the **▼▲** keys.

About the timer function

The maximum time that can be set for the timer is 999 hours 50 minutes.

Up to 99 hours 59 minutes, time can be set in minutes.

One hundred hours and over are set only in 10 minutes.

Keep the **▼▲** keys pressed to continuously change set time and you can quickly reach the time you want. Press the **▼▲** keys once at a time for fine adjustment.

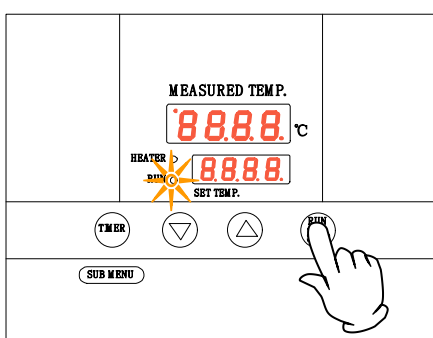

2. Starting timer operation

When the time you want is set, press the RUN/STOP key while the SET TEMP. screen is blinking.

The RUN lamp blinks and timer operation is started.

TIMER starts counting when the temperature in the bath reaches the set temperature.

Once timer counting is started, the SET TEMP. screen changes to the remaining time display.

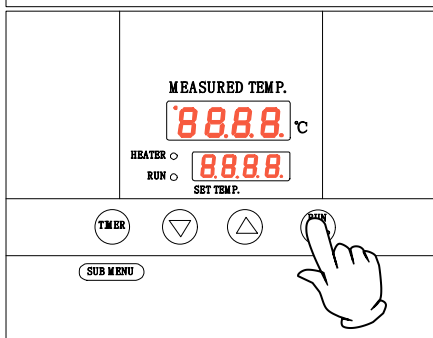

3. Stopping and ending timer operation

Operation stops automatically when the set temperature has elapsed.

Characters **End** **End** blink on the SET TEMP. screen to indicate operation has ended.

Press the **RUN/STOP** key for approx. one second to end the timer operation mode. The screen switches to the initial setting screen.

4. Operating procedures

Operating procedures (quick auto stop operation)

When you want to correct set temperature or set time, or change settings

When you want to change settings, press the ▼▲ keys on the current screen to enter the setting mode where you can change settings. Blink stops three seconds after three seconds after change and setting is completed. Note, however, that temperature changes after timer activation are counted also while temperature is changing.

When you want to change settings before timer activation, press the **TIMER** key on the current screen to enter the setting mode where you can change settings. Enter a time duration from when the set temperature is reached to the time the device shall be stopped.

When you want to change settings after timer activation, press the **TIMER** key on the current screen to enter the setting mode where you can change settings. Note, however, you need to set a time calculated by adding the time already passed to the time to be added.

After change has been made, press the **RUN/STOP** key to complete the process.

When you want to stop quick auto stop operation in the middle of it, press the **RUN/STOP** key long once to stop device control once, then make settings again in the appropriate mode.

In terms of the remaining time display  a blinking dot indicates count down, an illuminated dot indicates the wait status (temperature is increasing or decreasing to the set temperature) when the timer stops counting.

4. Operating procedures

Operating procedures (auto stop operation)

This mode automatically stops fixed temperature operation after a certain time from its start set with the timer.

Procedures for auto stop operation

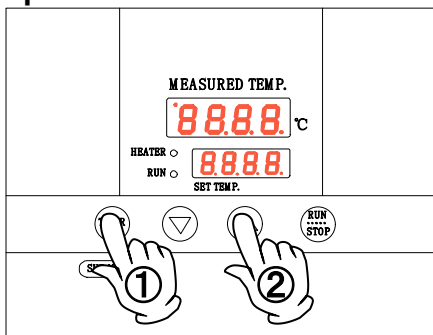

1. Setting a stop time

- ① After confirming the temperature you want is set, press the **TIMER** key to display characters AStP **ASTP** on the **MEASURED TEMP.** screen that indicate auto stop operation.
The set time is displayed on the **SET TEMP.** screen.
- ② Set a duration you want using the **▼ ▲** keys. Pressing the **▼▲** keys makes the set time blink. The time is determined when blinking stops.

About the timer function

The maximum time that can be set for the timer is 999 hours 50 minutes.

Up to 99 hours 59 minutes, time can be set in minutes.

One hundred hours and over are set only in 10 minutes.

Keep the **▼▲** keys pressed to continuously change set time and you can quickly reach the time you want. Press the **▼▲** keys once at a time for fine adjustment.

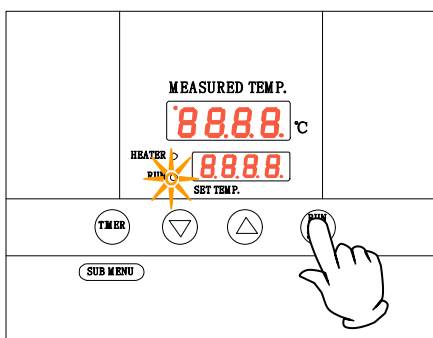

2. Starting timer operation

When the time you want is set, press the **RUN/STOP** key long while characters AStP **ASTP** that indicate auto stop operation are displayed on the **MEASURED TEMP.** screen and the set time on the **SET TEMP.** screen.

The **RUN** lamp blinks and timer operation is started.

TIMER starts counting when the temperature in the bath reaches the set temperature.

Once timer counting is started, the **SET TEMP.** screen changes to the remaining time display.

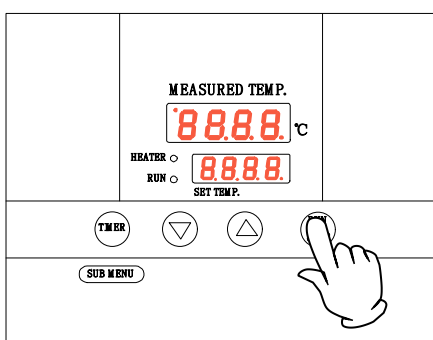

3. Stopping and ending timer operation

Operation stops automatically when the set temperature has elapsed.

Characters **End** **End** blink on the **SET TEMP.** screen to indicate operation has ended.

Press the **RUN/STOP** key for approx. one second to end the timer operation mode. The screen switches to the initial setting screen.

4. Operating procedures

Operating procedures (auto stop operation)

When you want to correct set temperature or set time, or change settings

When you want to change settings, press the ▼▲ keys on the current screen to enter the setting mode where you can change settings. Blink stops three seconds after three seconds after change and setting is completed. Note, however, that temperature changes after timer activation are counted also while temperature is changing.

When you want to change settings before timer activation, press the **TIMER** key on the current screen to enter the setting mode where you can change settings. Enter a time duration from when the set temperature is reached to the time the device shall be stopped.

When you want to change settings after timer activation, press the **TIMER** key on the current screen to enter the setting mode where you can change settings. Note, however, you need to set a time calculated by adding the time already passed to the time to be added.

After change has been made, press the **RUN/STOP** key to complete the process.

Auto stop operation is not available together with auto start operation.

When you want to stop auto stop operation in the middle of it, press the **RUN/STOP** key long once to stop device control once, then make settings again in the appropriate mode.

In terms of the remaining time display  a blinking dot indicates count down and an illuminating dot indicates a wait status (while temperature is increasing or decreasing to the set temperature) during which the timer has stopped counting.

4. Operating procedures

Operating procedures (auto start operation)

This mode automatically starts fixed temperature operation after a certain time from its start set with the timer.

However, operation does not stop automatically but needs to be stopped manually.

Procedures for auto start operation

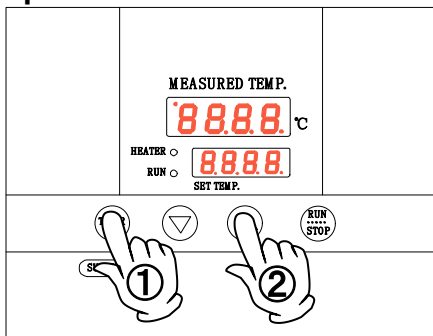

1. Setting an operation start time

① After confirming the temperature you want is set, press the **TIMER** key to display characters AStr **AStr** on the MEASURED TEMP. screen that indicate auto start operation.

The set time is displayed blinking on the set temperature screen.

② Set a duration you want using the **▼▲** keys.

Pressing the **▼▲** keys makes the set time blink. The time is determined when blinking stops.

About the timer function

The maximum time that can be set for the timer is 999 hours 50 minutes.

Up to 99 hours 59 minutes, time can be set in minutes.

One hundred hours and over are set only in 10 minutes.

Keep the **▼▲** keys pressed to continuously change set time and you can quickly reach the time you want. Press the **▼▲** keys once at a time for fine adjustment.

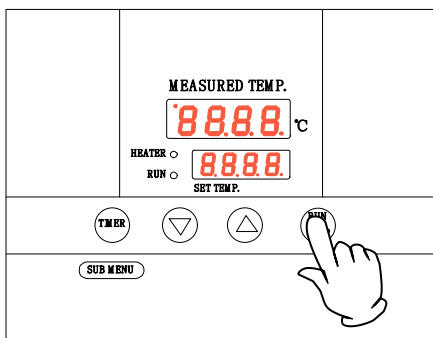

2. Starting timer operation

When the time you want is set, press the **RUN/STOP** key while characters AStr **AStr** that indicate auto start operation are displayed on the MEASURED TEMP. screen and the set time on the SET TEMP. screen.

Timer starts counting when the **RUN/STOP** key is pressed.

Display on the SET TEMP. screen switches from set time display to remaining time display.

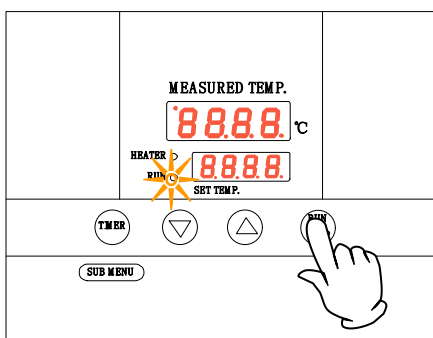

3. Stopping and ending timer operation

Operation automatically starts at the set time and the RUN lamp comes on.

To stop operation, press the **RUN/STOP** key for approx. one second to end the timer operation mode. The screen switches to the initial setting screen.

4. Operating procedures

Operating procedures (auto start operation)

When you want to correct set temperature or set time, or change settings

When you want to change the set temperature during timer counting, press the ▼▲ keys during that status to switch the SET TEMP. screen to the set temperature input mode, which blinks to enable change of the set temperature with the ▼▲ keys.

When you want to change the set time during timer counting, press the **TIMER** key during that status to switch the SET TEMP. screen to the set time input mode, which blinks to enable change of the set time with the ▼▲ keys.

In either case, the SET TEMP. screen will stop blinking after a while and switches to the timer count mode and the change made is determined. Note, however, when you change the set time you need to set a time calculated by adding the time already passed to the time to be added.

When operation has started after the auto start time, you cannot change the set time.

When you want to stop auto start operation in the middle of it, press the **RUN/STOP** key long to stop device control once, then make settings again in the appropriate mode.

In terms of the remaining time display  a blinking dot indicates count down and an illuminating dot indicates a wait status (while temperature is increasing or decreasing to the set temperature) during which the timer has stopped counting.

4. Operating procedures

Useful functions (calibration offset function)

Using the calibration offset function

Calibration offset function compensates any differences between the target temperature in the bath and the control temperature of the controller (sensor temperature.) The function can compensate in parallel to either plus or minus side for the whole temperature band of the unit.

The lock can be set or released with the **[SUB MENU]** keys.

The temperature is set at "0" on shipping from the factory.

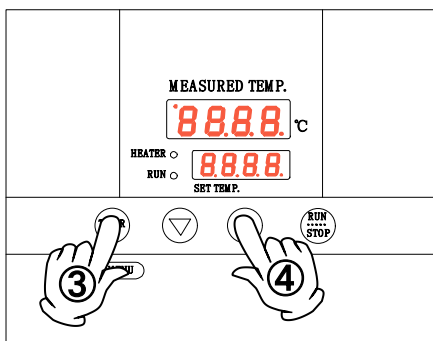
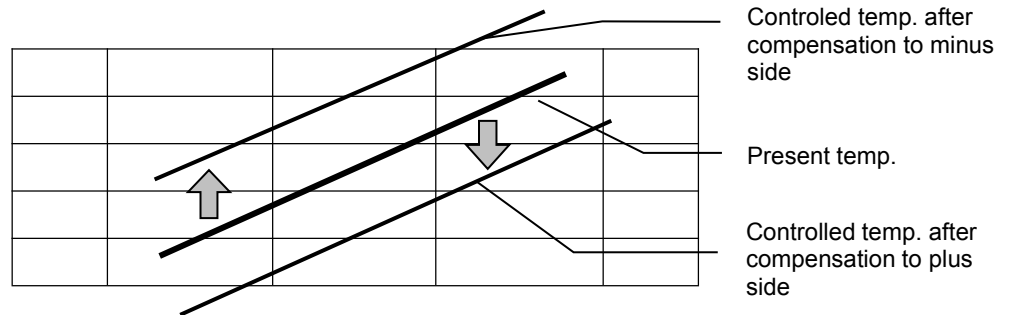

- ① Start operation at the target set temperature and confirm the temperature in the bath with a temperature recorder after temperature has stabilized.
- ② Confirm the difference between the set temperature and that in the bath.
- ③ Press the **[TIMER]** key (**[SUB MENU]** key) long to enter the sub menu mode. Press the **[TIMER]** key (**[SUB MENU]** key) several times to select the characters cAL **[cAL]** that indicate the calibration offset function.
- ④ Enter the difference between the set temperature and the temperature in the bath using the **▼▲** keys and press the **[TIMER]** key (**[SUB MENU]** key) long to exit the sub menu mode. (When you want to set the key lock function, proceed to character selection process for the key lock function without pressing the **[TIMER]** key (**[SUB MENU]** key) long.)

- * You can set either of + or – side for the offset compensation temperature. When compensation is set for the – side, the MEASURED TEMP. display decreases by the compensation temperature while the temperature in the bath increases by the same amount. When compensation is set for the + side, the MEASURED TEMP. display increases by the compensation temperature while the temperature in the bath decreases by the same amount.
- * Since too large a compensation value may result in larger difference between the actual and indicated temperatures and may present a danger, consult our nearest sales office before entering a large compensation value.
- * The device has, in addition to the calibration offset function, the two-point compensation function that adjusts offset for the lower temperature range and higher temperature range, for which adjustment temperatures have been input on shipping from the factory.
- * Consult the nearest sales office before attempting validation work for the temperature adjusting device.

4. Operating procedures

Useful function (setting lock function)

Using the lock function

This function locks the set operation status.

The temperature is set at “off” on shipping from the factory.

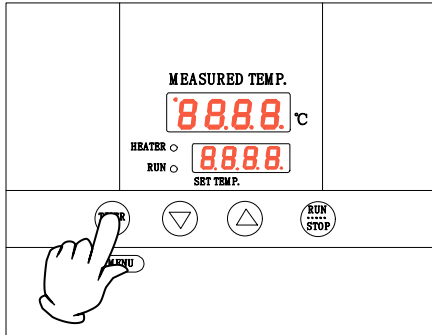

- ① Press the **TIMER** key (**SUB MENU** key) long to enter the sub menu mode. Press the **TIMER** key (**SUB MENU** key) several times to select the characters Lock **Loch** that indicate the setting lock function.

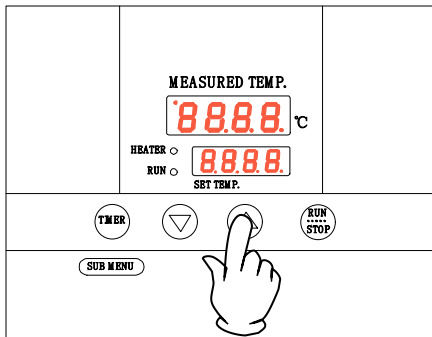

- ② “Off” is displayed on the SET TEMP. screen. To lock settings, change to “on” using the **▲** key. Press the **TIMER** key (**SUB MENU** key) long to exit the sub menu mode.

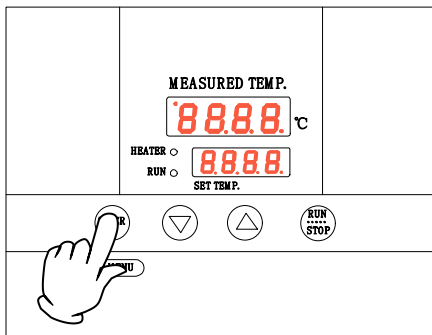

- ③ To release lock, press the **TIMER** key (**SUB MENU** key) long again and select the characters Lock **Loch** that indicate setting lock using the **▼▲** keys. Lock is released when “off” is selected using the **▼** key.

* When the lock function is “on”, keys other than the **RUN/STOP** key and the **TIMER** key (**SUB MENU** key) are locked.

4. Operating procedures

Useful function (power outage compensation function)

Using the power outage compensation function

The power outage compensation function returns the main unit operation to the resume status after recovery from power outage, or keeps the current stop status.

The function is set at “on” on shipping from the factory.

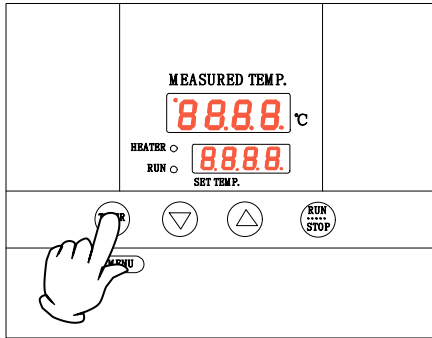

- ① Press the **TIMER** key (**SUB MENU** key) long to enter the sub menu mode.

Press the **TIMER** key (**SUB MENU** key) several times to select the characters Pon **Pon** that indicate the power outage compensation function.

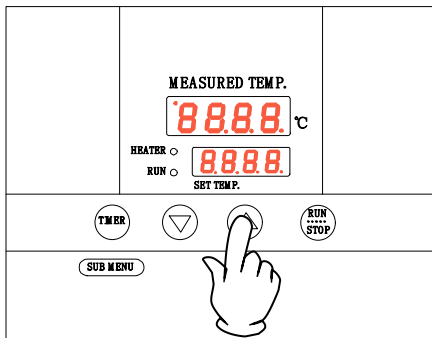

- ② “On” is displayed on the SET TEMP. screen. The device keeps stop status after recovery from power outage when this setting is set to “off” using the ▼ key. Press the **TIMER** key (**SUB MENU** key) long to exit the sub menu mode.

5. Cautions on handling



1. About handling of flammable or combustible solution

-  The unit is not explosion proof. Take special care for handling samples on which explosive materials, combustible materials or materials containing these are attached. Flammable or combustible solution will evaporate when left at a room temperature (or at a lower temperature for some types of solutions) and may be ignited and explode from switches, lights and other ignitable sources. Be sure to assure sufficient ventilation when using these materials.
- See section "13. List of dangerous materials" on page 38.

2. Ban on use/countermeasures when an error occurs

-  If smoke is emerges on the unit or an odd odor is felt, immediately turn the MCB on the main unit off, turn the power supply off and contact your dealer or a Yamato sales office for inspection. Otherwise, a fire or an electrical shock may result. The user shall never attempt to repair the unit to avoid any possible dangers.

3. Secure sufficient ventilation for the unit.

-  Do not operate the unit when its vent holes on the side and rear panels covered or blocked. Internal temperature of the unit will rise degrading the performance and an accident, a malfunction or a fire may result.

4. Do not allow liquid to spill over the unit.

-  Do not allow liquid to spill over the unit. Pay special attention not to allow liquid to enter into the vent holes on the side and rear panels of the unit. If liquid is spilt over or into the unit, do not try to operate it any further. Other wise, an accident, a malfunction, a fire or an electrical shock may result.

5. Do not allow a metal piece to fall into the unit.

-  Do not allow a clip, a staple, a screw or other metal pieces to fall into the unit. Stop operating the unit if a metal piece has dropped into the unit. Other wise, an accident, a malfunction, a fire or an electrical shock may result.

6. Do not open the cabinet.

-  Do not open panels or covers fixed on the unit, or do not operate the unit with any of those open. Other wise, an accident, a malfunction, or an electrical shock may result.

7. Always operate the unit at a correct ambient temperature.

-  The operating temperature range is room temperature range from 10~260°C above room temperature.
- Never try to operate the unit outside the operating temperature range.

8. Do not attempt to modify the unit.

-  The user shall never try to modify the unit; other wise, an accident, a malfunction, a fire or an electrical shock may result.

5. Cautions on handling



Caution

1. Do not step on the unit.



Do not step on the unit. Otherwise, the unit may trip over or be damaged resulting a personal injury or a malfunction.

2. Do not put or drop an object on the unit.



2.Do not put or drop an object on the unit. Since the unit contains high precision devices, vibrations or shock may cause a malfunction.

3. When a thunder is heard.



When a thunder is heard, turn the MCB on the main unit off then turn the main power off immediately. Otherwise, a lightning strike may result and cause a fire.

4. During night and not to be operated for a long period of time.



During the night and when you want to stop the unit for a longer period of time, turn the MCB to "off" and pull out the power cord from the power supply.

5. About recovery from power outage.



When the power is applied again after the unit has stopped due to power outage, the unit will automatically return to the status immediately before the power outage and resumes operation.

Turn the MCB off if you do not want to resume operation by automatic recovery.

6. About two-tier stacking



Use the dedicated optional parts to stack units in two tiers. Contact you dealer or the nearest sales office for the dedicated optional part.

7. When opening or closing the door



When opening or closing the door, do not put your hand or face close to the area the door moves (space).

The door may touch your hand or face and causing an injury.

8. Do not operate the unit with the door open.



- When the unit is operated with the door open, proper temperature control is not possible and the heater may overheat pausing a possible danger. Be sure to operate the unit with the door closed.

- After operation has been completed, do not leave the unit with its door open in order to, for example, cool down samples earlier. Heat from inside the bath may cause deformation of the control panel of a malfunction of the control devices.

5. Cautions on handling



9. About installation of shelf boards and samples



Install shelf boards and samples correctly according to “Installation procedures • precautions” on page 7. Otherwise, an accident or a malfunction may result not only to prevent the unit to operate at its maximum performance.

10. Do not attempt to do anything other than specified in this operation manual.



Do not attempt to do anything other than specified in this operation manual. Otherwise, an unexpected accident may result.

6. Maintenance procedures

Daily inspection/maintenance

Be sure to perform daily inspection and maintenance to assure reliable operation of the unit.

Warning

- Be sure to pull out the power cord unless necessary before trying to do inspection and maintenance works.
- Start these works after the device has returned to the normal temperature.
- Never try to disassemble the unit.

Caution

- Wipe off any dirt with a tightly wrung soft cloth. Never try to clean the unit with benzene, thinner or scouring powder, or rub with a scrubbing brush. Deformation, degradation or discoloration may result.

Maintenance of the internal bath

Stop operation and turn the MCB to OFF. Pull out the power cord off the distribution board and the wall outlet. Confirm the temperature in the device and remove shelf boards and clamps.

The internal bath, shelf boards and shelf clamps are made of stainless steel. To clean these items, thoroughly wipe with a cloth moistened with cleaning alcohol then wipe gently with a dry cloth.

Never use acid detergent, alkaline detergent, oil or organic solvent, which may cause corrosion or damage to the products.



There are sharp protrusions inside the internal bath, shelf boards and shelf pillars and shall be handled with special care to avoid personal injury. Be sure to wear gloves since handling with bare hands may present danger.

7. When the unit is not to be used for a long time or when disposing

When the unit is not to be used for a long time or when disposing



Caution

When the unit is not going to be used for a long time

- Turn the MCB to off and pull out the power cord.



Warning

When disposing the unit

- Do not leave the unit in the area where children may have access.
- Be sure to remove handles before disposing the unit to prevent the doors from locking.
- In general, dispose the unit as a bulky waste.

Notes about disposition

Always pay attention to the preservation of the global environment.

- We highly recommend taking the unit apart as far as possible for separation or recycling to contribute to the preservation of the global environment. Major components and materials for the unit are as follows:

Names of major components	Major materials
Major exterior components	
Exterior	Steel plate SPCC (powder coating)
Internal bath	Stainless steel
Heat insulator	Glass wool
Packing	Silicon rubber
Nameplates	Polyethylene (PET) resin film
Major electric parts	
Switches and relays	Resin, copper
Boards	Glass fiber and other composite parts
Heater	SUS304
Power cord	Synthesized rubber sheath, copper, nickel



8. Troubleshooting

Safety device and error codes

The unit has the self diagnostic function with a controller and a separate safety device.
Table below shows possible causes and measures when the safety device is triggered.

[Error codes]

When a functional or mechanical abnormality occurs, an error code will be displayed on the control panel. When an abnormality occurs, confirm the error code and immediately stop operation.

Safety device	Symptom	Possible causes and measures
Sensor error	 appears	<ul style="list-style-type: none">• Error in the temperature input circuit• Disconnection or other errors in the temperature sensor• Measured temperature is outside the displayable range. Contact our service department.
Measured temperature lower limit error	 appears	<ul style="list-style-type: none">• When the lower limit alarm of the temperature alarm function is triggered. Contact our service department.
Memory error	 appears	<ul style="list-style-type: none">• Memory setting error Contact our service department.
Measured temperature error	---- ---- appears	<ul style="list-style-type: none">• When the upper limit alarm of the temperature alarm function is triggered. Contact our service department.

8. Troubleshooting

When a malfunction is suspected

If any of the symptoms below occurs

Symptom	Check
Turning the MCB to on will not activate the unit.	<ul style="list-style-type: none">● Check if the power cord is connected to the power supply securely.● Check if power outage is occurring.● Check if the standalone overheat prevention device is working.
Temperature does not rise.	<ul style="list-style-type: none">● Check if the set temperature is below that in the device.● Check if the power supply voltage has declined.● Check if the ambient temperature is low.● Check if cooling load for inside the bath is too large.
Temperature fluctuates during operation.	<ul style="list-style-type: none">● Check if the set temperature is appropriate.● Check if the power supply voltage has declined.● Check if ambient temperature fluctuates widely.● Check if cooling load for inside the bath is too large.
Displayed temperature differs from the measurement.	<ul style="list-style-type: none">● Check if the calibration offset setting is other than "0". Set it to "0." Confirm the settings in "Using the calibration offset function" on page 24.

If power outage occurs

When the power is applied again after the unit has stopped due to power outage, the unit will automatically return to the status immediately before the power outage and resumes operation. Turn the MCB off if you do not want to resume operation by automatic recovery.

- ◆ If the symptom does not match any of the above, immediately turn the MCB on the main unit off, pull out the power cord from the power supply and contact your dealer or one of our sales offices.

9. After sales service and warranty

When requesting a repair

When requesting a repair

If any trouble occurs, immediately stop operation, turn the MCB off, pull out the power plug and contact your dealer or our sales office.

Information necessary for requesting a repair

- Model name of the product
 - Serial number
 - Date (y/m/d) of purchase
 - Description of trouble (as in detail as possible)
- } Refer to the warranty card or the nameplate on the unit.
} See “3. Names and functions of parts” on page 10.

Be sure to indicate the warranty card to our service representative.

Warranty card (attached separately)

- Warranty card is given by your dealer or one of our sales offices and please fill in your dealer, date of purchase and other information and store securely.
- Warranty period is one full year from the date of purchase. Repair service for free is available according to the conditions written on the warranty card.
- For repairs after the warranty period consult your dealer or one of our sales offices. Paid repair service is available on your request when the product's functionality can be maintained by repair.

Minimum holding period of repair parts

The minimum holding period of repair parts for this product is seven years after end of production.

Repair parts here refer to parts necessary for maintaining performance of the product.

10. Specifications

Model		DKM300C	DKM310C	DKM400C	DKM410	DKM600	DKM610
Performance	Operating temperature range	Room temperature +10°C~260°C					
	Temperature control precision	±1°C (setting: 210°C)					
	Temperature distribution precision	±2.5°C (setting: 210°C)					
	Temperature rise time	Approx. 90 minutes (room temperature ~260°C)					
Configuration	Cable port	ID 30 mm x 1 (right side)					
	Exhaust port	ID 30 mm x 2 (top side)					
	Fan motor	Sirocco fan x 1					
		10W					
	Heater	SUS pipe heater					
0.8 kW			1.2kW		1.34kW		
Control assembly	Control system	PID control with a micro computer					
	Setting system	Digital display using up/down keys					
	Operation mode	Fixed temperature operation, quick auto stop operation, auto stop operation, auto start operation.					
	Sensor	K thermocouple					
	Auxiliary functions	Calibration offset function, lock function, power outage compensation function					
Safety device	Self diagnostic function	Temperature sensor error, memory error, auto overheat prevention, measured temperature error					
	Protection device	MCB with an over current protector, hydraulic standalone overheat prevention device					
Standard	Outer dimensions (w x d x h mm)	410 × 451 × 670		560×601×820		710×651×870	
	Internal dimensions (w x d x h mm)	300 × 300 × 300		450×450×450		600×500×500	
	Internal volume	27L		90L		150L	
	Weight	Approx. 35 kg		Approx. 50 kg		Approx. 65 kg	
	Power supply (50/60Hz)	AC115V 7.5A	AC220V 4.5A	AC115V 11A	AC220V 6.5A	AC115V 12A	AC220V 7A
Included items	Shelf board x 2 (withstand load approx. 15 kg/each), operating instructions, warranty card						

The performance under the power supply condition of AC 115V and 220V are shown here.

Operating environmental temperature range for this device is 5°C~35°C.

11. Wiring diagram

DKM300C/400C/600C

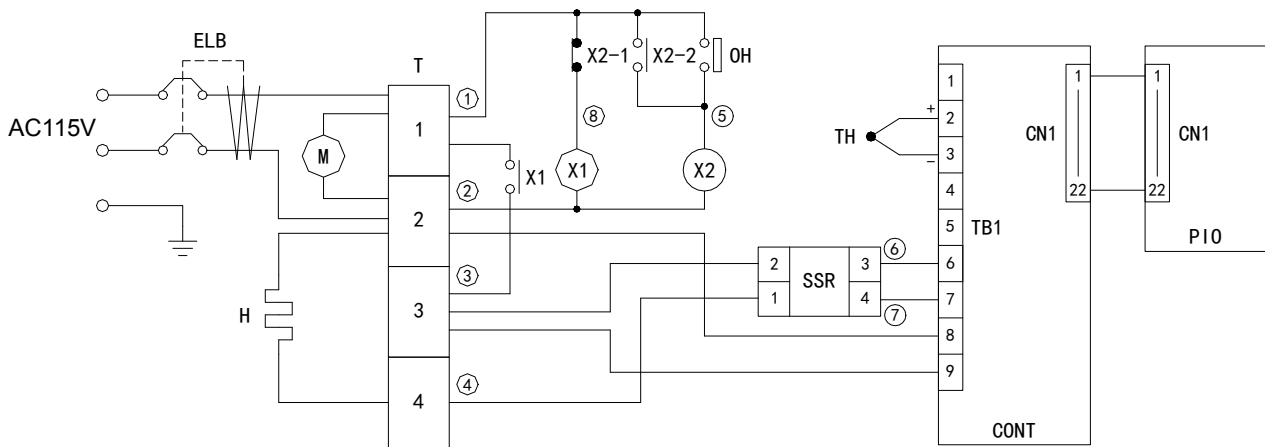

Symbol	Part name	Symbol	Part name
ELB	Circuit Breaker	SSR	Solid state relay
T	Terminal block	OH	Thermostat (Standalone overheat prevention device)
H	Heater	TH	Temperature sensor (K)
X1, X2	Relay	CONT	Planar board
M	Fan motor	PIO	Display circuit board

11. Wiring diagram

DKM310C/410C/610C

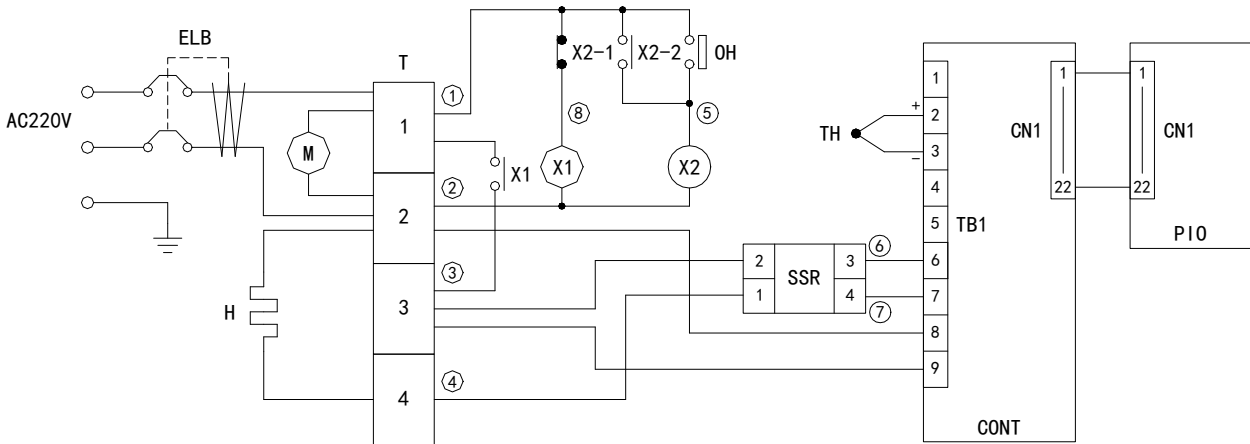

Symbol	Part name	Symbol	Part name
ELB	Circuit Breaker	SSR	Solid state relay
T	Terminal block	OH	Thermostat (Standalone overheat prevention device)
H	Heater	TH	Temperature sensor (K)
X1, X2	Relay	CONT	Planar board
M	Fan motor	PIO	Display circuit board

12. List of replacement parts

Replacement parts common to DKM300C/400C600C

Symbol	Part Name	Specification	Manufacturer	Code No.
ELB	Circuit breaker	KD-L2123 30A 30mA	Yamato Scientific	SJA04529
TH1	Sensor	φ 3.2*55*2000 K-single	Yamato Scientific	SJA14012
OH	Independent overheating prevention device	55.13265.010	E.G.O.	B020103001
CONT	CN40B-Y PLANAR board	CN40B-Y	Yamato Scientific	LT00007640
PIO	CN40B-Y display board	CN40B-Y	Yamato Scientific	LT00007639
	Tough card	15P, 300mm	Yamato Scientific	LT00007641
SSR	SSR	G3NB-225B-1 DC5~24V	Toho Denshi	A011006011

Replacement parts for DKM300C/400C/600C

Symbol	Part Name	Specification	Manufacturer	Code No.	
X1	Main relay	JQX116F-2/110AL1HSTFW	Matsushita	A011002001	
X2	Relay	JQX13F-2/A110V2Z1D	Matsushita	A011002005	
M	Motor	115V,10W,CCW	Yamato Scientific	B011603010	
	Power cord kit	2.0sq 3p plug	Yamato Scientific	A011208003	
H	Heater	DKM300C	SUS pipe heater 115V 0.8kW	Yamato Scientific	A080504009
		DKM400C	SUS pipe heater 115V 1.2kW	Yamato Scientific	
		DKM600C	SUS pipe heater 115V 1.34kW	Yamato Scientific	

Replacement parts for DKM310C/410C/610C

Symbol	Part Name	Specification	Manufacturer	Code No.	
X1	Main relay	JQX116F-2/220AL1HSTFW	Matsushita	SJA06060	
X2	Relay	JQX13F-2/A0V2Z1D	Matsushita	SJA06063	
M	Motor	220V,10W,CCW	Yamato Scientific	A011603004	
	Power cord kit	3×2.08mm ²	Yamato Scientific	A011210002	
H	Heater	DKM310C	SUS pipe heater 220V 0.8kW	Yamato Scientific	SJA04170
		DKM410C	SUS pipe heater 220V 1.2kW	Yamato Scientific	SJA04171
		DKM610C	SUS pipe heater 220V 1.34kW	Yamato Scientific	SJA04172

13. List of dangerous materials



Never use an explosive material, a flammable material or a material containing them for this device.

Explosive substances	Explosive substances	① Nitro glycol, glycerin trinitrate, cellulose nitrate and other explosive nitrate esters
		② Trinitrobenzen, trinitrotoluene, picric acid and other explosive nitro compounds
		③ Acetyl hydroperoxide, methyl ethyl ketone peroxide, benzoyl peroxide and other organic peroxides
Flammable substances	Explosive substances	Metal "lithium", metal "potassium", metal "natrium", yellow phosphorus, phosphorus sulfide, red phosphorus, celluloid, calcium carbide (a.k.a, carbide), lime phosphide, magnesium powder, aluminum powder, metal powder other than magnesium and aluminum powder, sodium dithionous acid (a.k.a., hydrosulphite)
	Oxidizing substances	① Potassium chlorate, sodium chlorate, ammonium chlorate, and other chlorates
		② Potassium perchlorate, sodium perchlorate, ammonium perchlorate, and other perchlorates
		② Potassium perchlorate, sodium perchlorate, ammonium perchlorate, and other inorganic perchlorates
		④ Potassium nitrate, sodium nitrate, ammonium nitrate, and other nitrates
		⑤ Sodium chlorite and other chlorites
		⑥ Calcium hypochlorite and other hypochlorites
	Flammable substances	① Ethyl ether, gasoline, acetaldehyde, propylene chloride, carbon disulfide, and other substances with ignition point at a degree 30 or more degrees below zero.
		② n-hexane, ethylene oxide, acetone, benzene, methyl ethyl ketone and other substances with ignition point between 30 degrees below zero and less than zero.
		③ Methanol, ethanol, xylene, pentyl acetate, (a.k.a. amyl acetate) and other substances with ignition point between zero and less than 30 degrees.
		④ Kerosene, light oil, terebinth oil, isopentyl alcohol (a.k.a. isoamyl alcohol), acetic acid and other substances with ignition point between 30 degrees and less than 65 degrees.
	Combustible gas	Hydrogen, acetylene, ethylene, methane, ethane, propane, butane and other gases combustible at 15 degrees at one air pressure.

14. Standard installation manual

*Install the product according to the following: (Confirm separately for optional items or special specifications)

Model	Serial number	Date	Installation mgr. (company name)	Installation mgr.	Judgment

No.	Item	Implementation method	TOC No. Reference page of the operating instruction manual	Judgment
Specifications				
1	Included items	Check for number of staffs against the included item field	10.Specifications field P.35	
2	Installation	<ul style="list-style-type: none"> ▪ Visual check of environmental conditions Caution: Take care for environment 	2. Before operating the unit <ul style="list-style-type: none"> ▪ On the installation site P.4 	
		<ul style="list-style-type: none"> ▪ Securing a space 		
Operation-related matters				
1	Source voltage	<ul style="list-style-type: none"> ▪ Measure the user side voltage (outlet) with a tester ▪ Measure voltage during operation (shall meet the specifications) Caution: Always use a plug that meets the specification for attaching to the MCB. 	2. Before operating the unit <ul style="list-style-type: none"> ▪ Be sure to connect the ground wire. P.6 ▪ Power supply is P.6 10.Specifications <ul style="list-style-type: none"> ▪ Specification-power supply P.35 	
2	Operation start	<ul style="list-style-type: none"> ▪ Starts operation Performs fixed temperature operation, auto stop operation or auto start operation 	2. Before operating the unit... P.8~9 <ul style="list-style-type: none"> ▪ Installation procedures... 4. Operating procedures P.13~26	
Description				
1	Operational descriptions	Explain operations of each component according to the operational instructions	4. Operating procedures P.13~26 <ul style="list-style-type: none"> ▪ Operating procedures 1. Safety precautions P.1~13.List of dangerous materials ~39	
2	Error codes	Explain the customer about error codes and procedures for release according to the operational instructions	8. Troubleshooting ~9. After sales service and warranty P.32~34	
3	Maintenance and inspection	Explain operations of each component according to the operational instructions	6. Maintenance procedures <ul style="list-style-type: none"> ▪ Daily inspection/maintenance P.30 	
4	Completion of installation Entries	<ul style="list-style-type: none"> ▪ Fill in the installation date and the installation mgr. on the nameplate of the main unit ▪ Fill in necessary information to the warranty card and hand it over to the customer ▪ Explanation of the route for after-sales service 	9. After sales service and warranty P.34	

Responsibility

Please follow the instructions in this document when using this unit. Yamato Scientific has no responsibility for the accidents or breakdown of device if it is used with a failure to comply. Never conduct what this document forbids. Unexpected accidents or breakdown may result in.

Note

- ◆ The contents of this document may be changed in future without notice.
- ◆ Any books with missing pages or disorderly binding may be replaced.

Instruction Manual
Forced Convection Constant Temperature Oven
Model DKM300C/400C/600C/310C/410C/610C
First Edition 12 June 2015

Yamato Scientific America, Inc.
925 Walsh Ave, Santa Clara, CA 95050
Tel:408-235-7725
For technical information
and service, call: 1-800-292-6286
<http://www.yamato-usa.com>

