

# UEI

TEST INSTRUMENTS™

# DL489

## Commemorative Edition True RMS Digital Clamp-On Meter

INSTRUCTION MANUAL

ENGLISH

# 50<sup>TH</sup> ANNIVERSARY

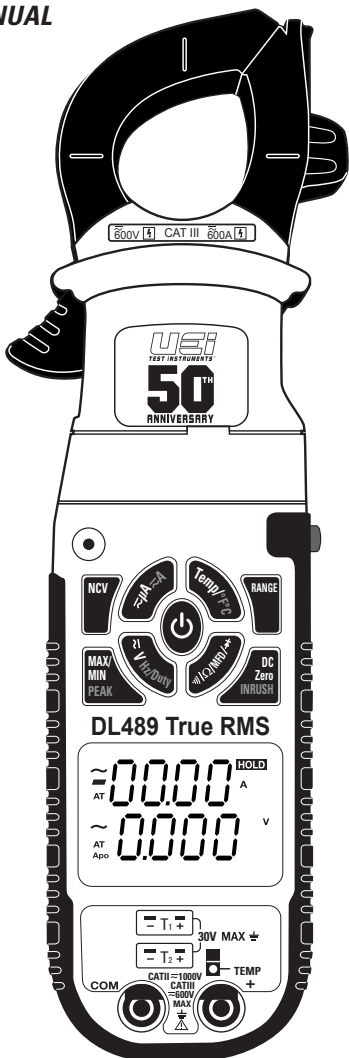

Intertek

600V

CAT III

1000V

CAT II

RoHS  
Compliant



1-800-547-5740

www.ueitest.com • email: info@ueitest.com

## TABLE OF CONTENTS

<b>FEATURES</b> .....	3
<b>GENERAL SPECIFICATIONS</b> .....	3
<b>IMPORTANT SAFETY WARNINGS</b> .....	3 - 4
<b>CATEGORY DEFINITIONS</b> .....	4
<b>SYMBOLS</b> .....	5
<b>OVERVIEW</b> .....	5 - 7
<b>OPERATING INSTRUCTIONS</b>	
AC Amps: < 600A – Jaw .....	7
DC Amps: <600A – Jaw .....	8
Non-Contact Voltage .....	8
Zero DC Amps .....	9
AC/DC Low Amps: <2000 $\mu$ A .....	9
Temperature F°/C° .....	10
Continuity .....	10
Resistance: < 60M $\Omega$ .....	11
Capacitance (MFD).....	11
Diode .....	12
Min/Max/Peak .....	12
Voltage: AC 750V / DC 1000V.....	13
Frequency (Hz) / Duty Cycle .....	14
Battery Replacement .....	14
LRA Inrush .....	15
Test Lead Notes .....	15
<b>WARRANTY</b> .....	16
<b>DISPOSAL</b> .....	16
<b>CLEANING</b> .....	16
<b>STORAGE</b> .....	16

## FEATURES

- True RMS
- 600A AC/DC
- 750V AC/1000V DC
- Resistance 60M $\Omega$
- Capacitance 2000 $\mu$ F
- AC/DC microamps 2000 $\mu$ A
- Frequency 99.99kHz
- Dual Temperature Differential
- Non-Contact Voltage
- LRA Inrush
- Data hold
- Min/Max
- Peak hold
- Visible high-voltage alert
- Manual ranging option
- Worklight/ back lit display
- Low battery indicator
- Auto power off
- Magnetic mount
- Dual display
- Input jack locks
- Detachable clamp head

## GENERAL SPECIFICATIONS

- **Operating Temperature:** 32° to 122°F (0° to 50°C)
- **Storage Temperature** -4°F to 140°F (-20° to 60°C)
- **Operating Humidity:** <80%
- **Operating Altitude:** 6,562 ft (2,000m)
- **Pollution Degree:** 2
- **Display:** 3 5/6 digits, 6,000 count
- **Refresh Rate:** 3/sec
- **Over-range:** "OL" is displayed
- **Dimensions:** 10.2" X 2.5" X 1.5"
- **Item Weight:** 1 lb.
- **Calibration:** Recommended annually
- **CAT Rating:** CAT III 600V/CAT II 1000V
- **Certifications:** cETLus 3rd Edition, CE Conformity, IEC 61010-1 3rd Edition, IP42, 6' Drop Protection, RoHS,
- **Battery Type:** (AAA) X 6
- **Test Leads:** Test leads w/alligator clips CATIV 600V/CATII 1000V

## IMPORTANT SAFETY WARNINGS

### **WARNING**

Read entire Safety Notes section regarding potential hazard and proper instructions before using this meter. In this manual the word "**WARNING**" is used to indicate conditions or actions that may pose physical hazards to the user. The word "**CAUTION**" is used to indicate conditions or actions that may damage this instrument.

### **WARNING**

To ensure safe operation and service of the tester, follow these instructions. Failure to observe these warnings can result in severe injury or death.

### **WARNING**

- Before each use, verify meter operation by measuring a known voltage or current.
- Never use the meter on a circuit with voltages that exceed the category based rating of this meter.
- Do not use this meter during electrical storms or in wet weather.
- Do not use the meter or test leads if they appear damaged.
- Ensure meter leads are fully seated and keep fingers away from the metal probe contact when making measurements. Always grip the leads behind the finger guards molded into the probe.
- Do not open the meter to replace batteries while the probes are connected.

## IMPORTANT SAFETY WARNINGS (CONT.)

- Use caution when working with voltages above 60V DC or 25V AC RMS. Such voltages pose shock hazards.
- To avoid false readings that can lead to electrical shock, replace batteries if a low battery indicator appears.
- Unless measuring voltage or current, shut off and lockout power before measuring resistance or capacitance.
- Always adhere to national and local safety codes. Use proper personal protective equipment (PPE) to prevent shock and arc blast injury where hazardous live conductors are exposed.
- Always turn off power to a circuit or assembly under test before cutting, unsoldering or breaking the current path. Even small amounts of current can be dangerous.
- Always disconnect the live test lead before disconnecting the common test lead from the circuit.
- In the event of electrical shock, ALWAYS bring the victim to the emergency room for evaluation, regardless of victim's apparent recovery. Electrical shock can cause unstable heart rhythms that may need medical attention.
- If any of the following occurs during testing, turn off the power source to the circuit being tested: arcing, flame, smoke, extreme heat, smell of burning materials or discoloration melting of components.

### **WARNING**

Higher voltages and currents require greater awareness of physical safety hazards. Before connecting the test leads, turn off power to the circuit under test, set meter to the desired function and range, connect the test leads to the meter first, then connect to the circuit under test. Reapply power. If an erroneous reading is observed, disconnect power immediately and recheck all settings and connections.













### **WARNING**

This meter is designed for trade professionals who are familiar with the hazards of their trade. Observe all recommended safety procedures that include proper lock-out utilization and use of personal protective equipment that includes safety glasses, gloves and flame resistant clothing.

## CATEGORY DEFINITIONS

Measurement Category	Short-Circuit (typical) kA <sup>a</sup>	Location in the building installation
II	< 10	Circuits connected to mains socket outlets and similar points in the MAINS installation
III	< 50	Mains distributions parts of the building
IV	> 50	Source of the mains installation in the building

## SYMBOLS

	<b>AC</b> (Alternating current)		<b>DC</b> (Direct current)
	<b>Negative DC</b>		<b>AC/DC Voltage or Current</b>
<b>AT</b>	<b>Auto-ranging</b>	<b>OL</b>	<b>Overload: Range Exceeded</b>
<b>Apo</b>	<b>Auto power off Active</b>	<b>NCV</b>	<b>Non-Contact Voltage</b>
	<b>Low Battery</b>	<b>HOLD</b>	<b>Hold/Capture Value</b>
<b>MIN</b>	<b>Minimum measured value displayed</b>	<b>MAX</b>	<b>Maximum measured value displayed</b>
<b>%</b>	<b>Duty Cycle</b>	<b>Hz</b>	<b>Hertz/Frequency</b>
<b>V</b>	<b>Voltage</b>	<b>A</b>	<b>Amperage</b>
<b>Ω</b>	<b>Ohms/Resistance</b>		<b>Diode</b>
<b>MFD</b>	<b>Capacitance mode in nanofarads or microfarads</b>	<b>μF</b>	<b>Microfarad</b>
<b>°F</b>	<b>Degrees Fahrenheit</b>	<b>°C</b>	<b>Degrees Celsius</b>
	<b>Continuity</b>	<b>M</b>	<b>Mega (x10<sup>6</sup> or 1,000,000)</b>
<b>m</b>	<b>Milli (x10<sup>-3</sup> or 0.001)</b>	<b>k</b>	<b>Kilo (x10<sup>3</sup> or 1,000)</b>
<b>n</b>	<b>Nano (x10<sup>-9</sup> or 0.000000001)</b>	<b>μ</b>	<b>Micro (x10<sup>-6</sup> or 0.000001)</b>
<b>μA</b>	<b>Microamps</b>		<b>Warning or Caution</b>
	<b>Ground</b>		<b>Dangerous Levels</b>
	<b>Double Insulation (Protection to Class II)</b>		<b>Safe for disconnect from live conductors</b>

## OVERVIEW

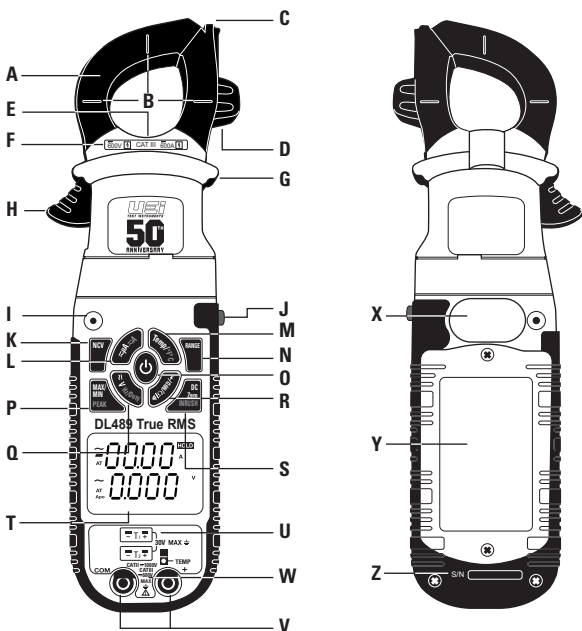

## OVERVIEW (CONT.)

- A. Clamp:** Measure inductive AC/DC current. Opens to 1.25" (31.7mm).
- B. Conductor Alignment Marks:** Use to aid the visual alignment of a conductor when measuring inductive amperage. Greatest accuracy is achieved when the conductor inside the clamp is centered at the intersection of these marks.
- C. Wire Separation Tab/ NCV sensor:** Use to isolate an individual wire from a bundle for testing. NCV sensor detects live voltage.
- D. Test Lead Holder:** Used for hands-free use of the test probes.
- E. Worklight:** Lights clamp area in dark work environments.
- F. Category Max Indicator:** Maximum CAT Rating for clamp jaw.
- G. Hand Guide:** Used as a point of reference for the operator's safety.
- H. Clamp Lever:** Opens and closes current clamp jaw.  
**NOTE:** *The clamp uses a high-tension spring to close the jaw. Do not allow fingers or objects to become pinched in the base as the jaws close.*
- I. NCV Alert Light:** Indicates voltage when in NCV mode and high-voltage alert.
- J. Hold/Worklight/ Back light Button:**
- Press to hold the reading on the display. Press again to return to live reading.
  - Press and hold to turn on Worklight and Back light. Press and hold again to turn off.
  - Worklight and Backlight turn off after 60 seconds.
- K. NCV Button:** Press and hold for Non-contact voltage detection mode.
- L. AC/DC Amps/ Microamps Button:**
- Press to enter AC/DC Amps mode; (AC/DC Amps upper display)
  - Press again to enter AC/DC Microamps ( $\mu\text{A}$ ) mode; (AC/DC microamps lower display),
- M. Temperature Button:**
- Press to enter temperature mode for T1 (upper temperature input jack).
  - Press again to enter temperature mode for T2 (lower temperature input jack).
  - Press again to enter temperature differential mode (T1-T2).
  - Press and hold to change temperature scale.
- N. Range Button:**
- Press to toggle to between Auto and Manual Ranging modes. (AT will appear on display when in Auto Ranging mode).
  - Press repeatedly to cycle through manual ranges when in Manual Ranging mode.
  - Press and hold to return to auto ranging mode.
- Note:** *Select range prior to MIN/MAX for best results.*
- O. Power Button:** Press to turn on and off the meter.
- P. Min/Max/ Peak Button:**
- Press to enter Min/Max mode. Max is the default setting.
  - Press repeatedly to cycle through Min/Max captured values.
  - Press and hold to return to live readings.
  - Press and hold to enter Peak mode.
  - Press and hold again to return to live readings.
- Q. AC/DC Volts/ Hertz (Hz)/ Duty Cycle Button:**
- Press to enter AC Voltage mode.
  - Press again to enter DC Voltage mode.
  - Press and hold to enter Hertz (Hz)/Duty Cycle modes.
  - Press to return to live readings.
- R. Continuity/ Resistance/ Capacitance/ Diode Test Button:**
- Press to enter Continuity mode.
  - Press again to enter Resistance mode.
  - Press again to enter Capacitance mode.
  - Press again to enter Diode test mode.
  - Press again to return to live readings.

### S. DC Zero/ Inrush Button:

- Press to Zero the DC clamp reading.
- Press and hold to enter LRA Inrush mode (must be in AC amp mode first).
- Press and hold again to return to live readings.

### T. Display:

- High contrast dual backlit display.
- Amps (AC/DC) reading will always display on upper display.

### U. K-Type Temperature Probe Inputs: T1 (Upper) and T2 (Lower)

### V. Input Jack Lock: Switch to use Temperature or Test lead inputs

### W. Category Max Indicator: Maximum CAT Rating for input jacks.

- Multifunction Input Port: Used for measuring: AC or DC volts, resistance, continuity, diode, capacitance, AC or DC amps, AC or DC  $\mu\text{A}$  or LRA Inrush.
- Use CATIII test leads or higher

### X. Magnetic Mount: For hands-free work.

### Y. Battery Cover: Easy access for replacing batteries without breaking calibration seal.

### Z. Serial Number

**Apo:** Auto power off after 30 minutes of use.

**Detachable Clamp Head:** Compatible with industry standard meter heads. ADP will appear on display. Press DC Zero to zero the head reading.

## AC Amps: < 600A – Jaw

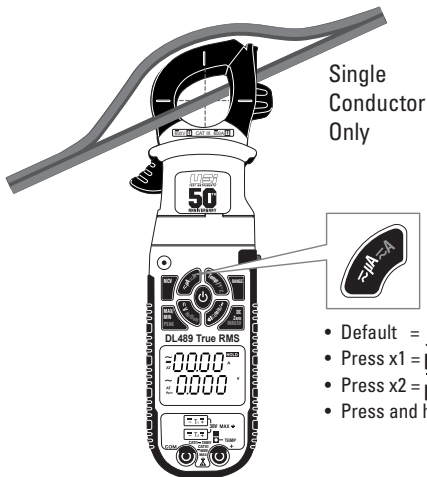

Single  
Conductor  
Only

- Default =  $\sim$  (upper)
- Press x1 =  $\sim \mu\text{A}$  (lower)
- Press x2 =  $\overline{\mu\text{A}}$  (lower)
- Press and hold =  $\overline{\mu\text{A}}$  (upper)

- Center wire in guides for best accuracy.
- Opposing currents cancel each other (use line-splitter when necessary).
- Keep hands below guard when measuring high current levels.
- Do not attempt to measure more than 600A AC.
- 45Hz to 400Hz True RMS
- Minimum current for Clamp measurement: 0.3A

### Features:



Range	Resolution	Accuracy	Overload Protection
60A	0.01A	$\pm(2.0\% + 8 \text{ dgts})$	600V RMS
600A	0.1A		

Minimum current for Clamp measurement: 0.3A

## DC Amps: <600A – Jaw

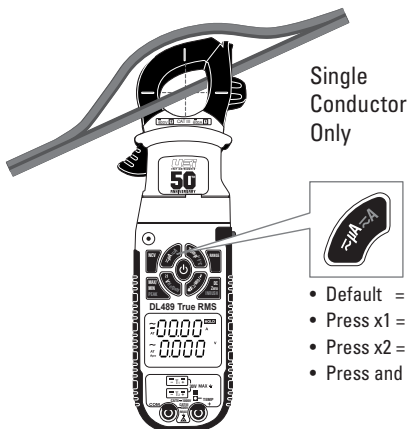

Single  
Conductor  
Only

- Default =  $\sim$  (upper)
- Press x1 =  $\mu\text{A}$  (lower)
- Press x2 =  $\overline{\mu\text{A}}$  (lower)
- Press and hold =  $\equiv$  (upper)

- Do not attempt to measure more than 600A DC.

Features:



Range	Resolution	Accuracy	Overload Protection
60A	0.01A	$\pm(2.0\% +8 \text{ dgts})$	600V RMS
600A	0.1A		

Minimum current for Clamp measurement: 0.3A

## Non-Contact Voltage

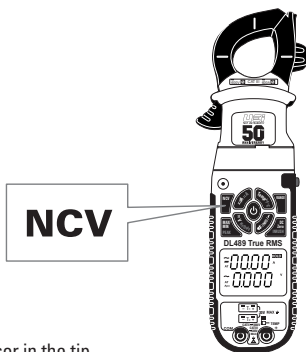

NCV Sensor in the tip.

- Press and hold the NCV button and move the tip of the clamp meter near voltage source.
- Non-Contact Voltage Detection is used to detect power with sensor located in the tip of the clamp head, indicates positive response with both an Audible and Visual alert.
- Do not use Non-contact voltage detector to determine if there is current on the wire. Detection operation could be affected by socket design, insulation thickness, type or other factors.
- Voltage indicator light may also light when voltage (>AC/DC 30V) is present on the meter's input jack or from an external interference such as motors, flashlights, etc.

**On Voltage**

Approx. 24V AC



## Zero DC Amps

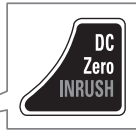
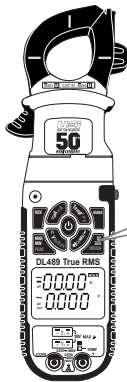

- Default = DC Zero
- Press and Hold = LRA Inrush

Select DC current.

- Press to zero any offset in Amps DC.
- Used to monitor change from present displayed value.
- Required during DC Amps measurement to establish a zero level.

### **WARNING**

Do not use DC Zero mode at amps greater than 600A DC or 2000 $\mu$ A DC.

## AC/DC Low Amps: <2000 $\mu$ A

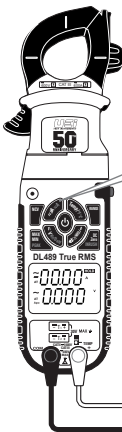

- Default =  $\sim$  (upper)
- Press x1 =  $\mu$ A (lower)
- Press x2 =  $\overline{\mu}$ A (lower)
- Press and hold =  $\equiv$  (upper)

### **WARNING**

- Do not attempt to measure more than 2000 $\mu$ A.

Features:



Range	Resolution	Accuracy	Overload Protection
600 $\mu$ A	0.1 $\mu$ A	$\pm$ (1.2% +3 dgts)	600V RMS
2000 $\mu$ A	1 $\mu$ A		

True RMS: 45Hz to 400Hz

## Temperature F°/C°

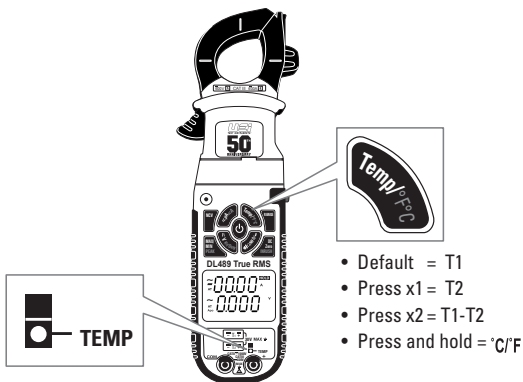

- Default = T1
- Press x1 = T2
- Press x2 = T1-T2
- Press and hold = °C/°F

Range	Resolution	Accuracy	Overload Protection
-328°F to 999°F (-200° to 999°C)	0.1°F (0.1°C)	±(1.0% + 3.6°F) ±(1.0% + 2.0°C)	30V RMS
1000°F to 2462°F (1000° to 1350°C)	1°F (1°C)		

- Disconnect test lead probes from voltage source and meter.
- Move Input Jack Locks to "TEMP" setting.
- Use K-Type thermocouple temperature probes only.
- Stated accuracy does not account for thermocouple accuracy.

Features:



## Continuity

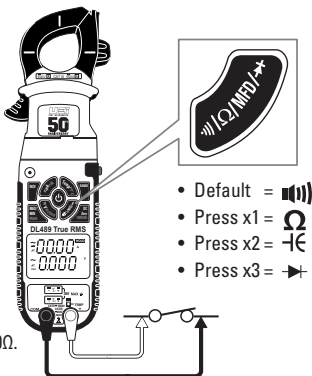

- Buzzer sounds at less than <math>40\Omega</math>.

**⚠ WARNING**

- Do not measure resistance on a live circuit.

Features:



Open Circuit V <math><1.00V</math>	Overload Protection
Threshold Approx. <math><40\Omega</math>	600V RMS

## Resistance: <math> < 60M\Omega </math>

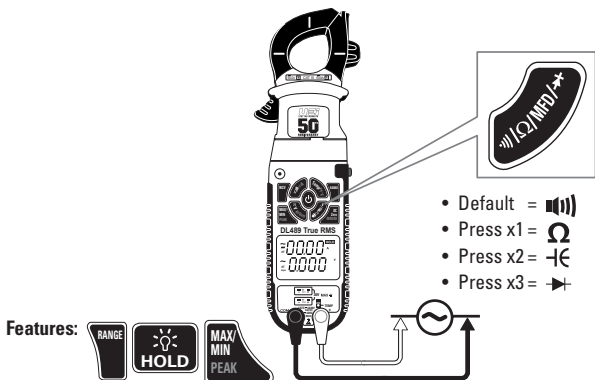

Range	Resolution	Accuracy	Overload Protection
600 $\Omega$	0.1 $\Omega$	$\pm (0.8\% + 3 \text{ dgts})$	600V RMS
6k $\Omega$	1 $\Omega$		
60k $\Omega$	10 $\Omega$		
600k $\Omega$	100 $\Omega$		
6M $\Omega$	1k $\Omega$		
60M $\Omega$	0.01M $\Omega$	$\pm (1.2\% + 3 \text{ dgts})$	

## Capacitance (MFD)

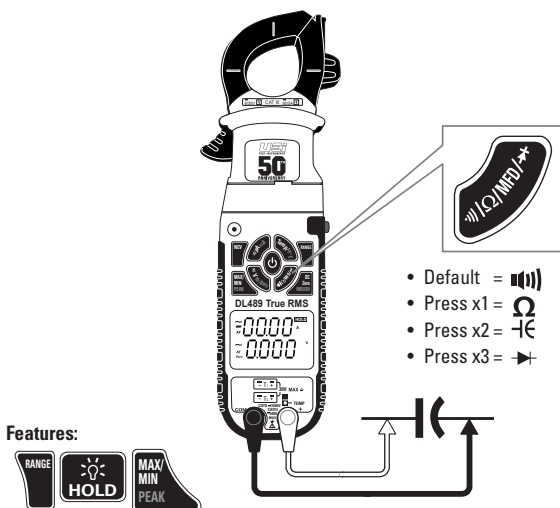

Range	Resolution	Accuracy	Overload Protection
10.00nF	0.01nF	$\pm (3.0\% + 5 \text{ dgts})$	600V RMS
100.0nF	0.1nF		
1.000 $\mu$ F	0.001 $\mu$ F		
10.00 $\mu$ F	0.01 $\mu$ F		
100.0 $\mu$ F	0.1 $\mu$ F		
2000 $\mu$ F	1 $\mu$ F		

## Diode

### GOOD DIODE

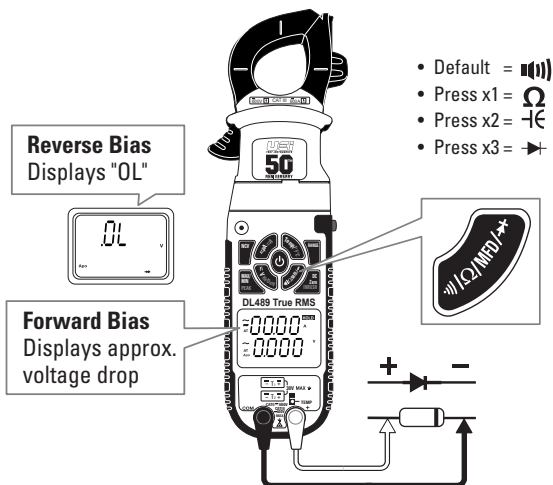

### BAD DIODE



- Forward voltage drop if forward biased.
- "O.L." if reverse biased.

Features:



#### Diode Test

Range	Open Circuit V	Test Current	Overload Protection
3.0V	<3.2V DC	0.25mA	600V RMS

## Min/Max/Peak

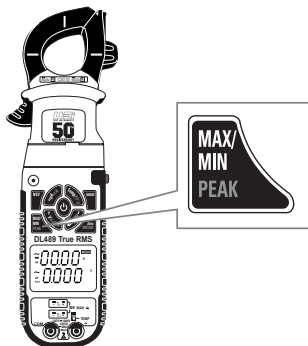

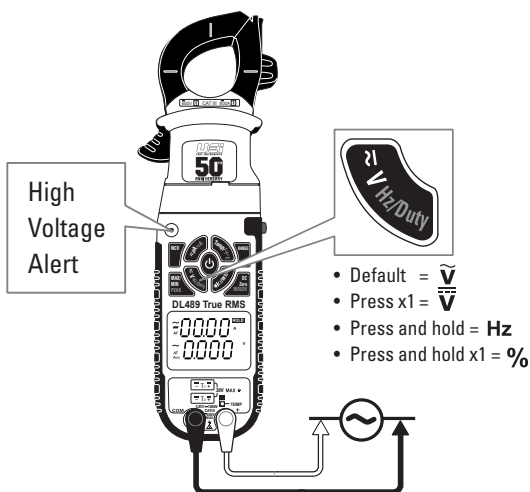

**! WARNING**

- Use CATIII rated test leads or higher.
- Do not attempt to measure more than 750V AC/1000V DC.
- Keep hands below line when measuring high current levels.
- Do not exceed 25 volts AC or DC – RMS at either the common or multifunction input ports as measured from earth ground.
- Select AC or DC Voltage.

**! WARNING**

- NCV LED will flash and audible alert over 600V AC/DC
- NCV LED will flash without audible alert over 30V AC/DC

Features:



**AC Volts (45Hz to 400Hz)**

Range	Resolution	Accuracy	Overload Protection
600mV	0.1mV	± (1.0% +3 dgts)	1000V RMS
6V	1mV		
60V	10mV		
600V	100mV		
750V	1.0V		

True RMS: 45Hz to 400Hz

**DC Volts**

Range	Resolution	Accuracy	Overload Protection
600mV	0.1mV	± (0.5% +4 dgts)	1000V RMS
6V	1mV		
60V	10mV		
600V	1000mV		
1000V	1V	±(0.8% +5 dgts)	

## Frequency (Hz) / Duty Cycle

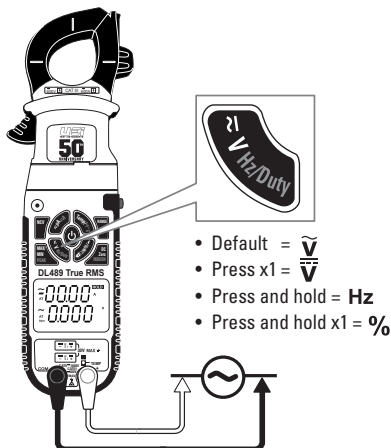

**⚠ Use CAT III rated leads or higher.**

Press the AC/DC volts button to select AC voltage, press and hold the button for Frequency and Duty Cycle modes.

**⚠ WARNING**

Do not attempt to measure more than 750V AC/1000V DC.

Features:



**Frequency**

Range	Resolution	Accuracy	Overload Protection
99.99Hz	0.01Hz	± (0.1% +3 dgts)	600V RMS
999.9Hz	0.1Hz		
9.999kHz	1Hz		
99.99kHz	10Hz		

**Duty Cycle**

Range	Resolution	Accuracy	Overload Protection
1.0 to 99.0%	0.1%	±(0.2% per kHz + 0.1% + 5dgts)	600V RMS

Frequency Sensitivity: 1.8Vrms

## Battery Replacement

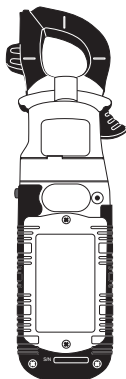

- **+** **-** When the batteries are too low for safe operation, the Low Battery indicator will display
- Remove the screws from the battery cover. Remove battery cover.
- Replace the old batteries with 6 new (AAA) batteries.
- Replace the battery cover.
- Replace the screws.

## LRA Inrush



- Default = DC Zero
- Press and hold = LRA Inrush

The UEi LRA Inrush is programmed to properly capture the starting current for compressor motors.

- Select AC Amps.
- Select the range capable of capturing the maximum value.
- Press and hold the DC Zero/ LRA Inrush button – INRUSH will now be shown on the screen.
- Activate the compressor and read value on the display.
- Press and hold the DC Zero/ LRA Inrush button to return to live readings.

## Test Lead Notes

### Cat IV and CAT III Measurement Locations

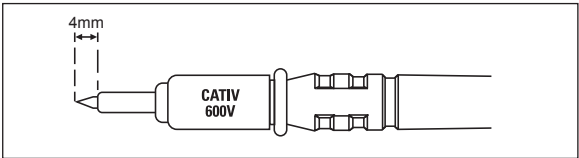

- Ensure the test lead shield is pressed firmly in place. Failure to use the CAT IV shield increases arc-flash risk.

### CAT II Measurement Locations

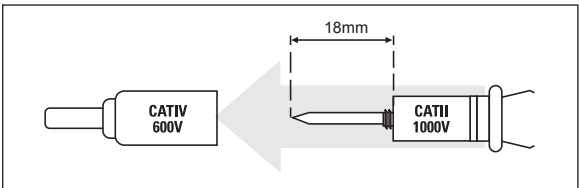

- CAT IV shields may be removed for CAT II locations. This will allow testing on recessed conductors such as standard wall outlets. Take care not to lose the shields.

**⚠ WARNING:** Test Lead category protections apply only to test leads and should not be confused with the meter's specific CAT rating. Observe the maximum category protection indicated on the meter the test leads are plugged into.

**⚠ CAUTION:** If the test leads need to be replaced, you must use a new one which should meet EN 61010-031 standard, rated CAT III 1000V or better.

## WARRANTY

The DL489 is warranted to be free from defects in materials and workmanship for a period of 2 years from the date of purchase. If within the warranty period your instrument should become inoperative from such defects, the unit will be repaired or replaced at UEi's option. This warranty covers normal use and does not cover damage which occurs in shipment or failure which results from alteration, tampering, accident, misuse, abuse, neglect or improper maintenance. Batteries and consequential damage resulting from failed batteries are not covered by warranty.

Any implied warranties, including but not limited to implied warranties of merchantability and fitness for a particular purpose, are limited to the express warranty. UEi shall not be liable for loss of use of the instrument or other incidental or consequential damages, expenses, or economic loss, or for any claim or claims for such damage, expenses or economic loss.

A purchase receipt or other proof of original purchase date will be required before warranty repairs will be rendered. Instruments out of warranty will be repaired (when repairable) for a service charge.

For more information on warranty and service, contact:

**www.ueitest.com • Email: info@ueitest.com**  
**1-800-547-5740**

This warranty gives you specific legal rights. You may also have other rights, which vary from state to state.

## DISPOSAL



**CAUTION:** This symbol indicates that equipment and its accessories shall be subject to separate collection and correct disposal.

## CLEANING

Periodically clean your meter's case using a damp cloth. DO NOT use abrasive, flammable liquids, cleaning solvents, or strong detergents as they may damage the finish, impair safety, or affect the reliability of the structural components.

## STORAGE

Remove the batteries when instrument is not in use for a prolonged period of time. Do not expose to high temperatures or humidity. After a period of storage in extreme conditions exceeding the limits mentioned in the General Specifications section, allow the instrument to return to normal operating conditions before using it.