



# Forced Convection Constant Temperature Oven

**DNE401/411**

**DNE601/611**

**DNE811**

**DNE911**

## Instruction Manual



First Edition

- Thank you for purchasing “Forced Convection Constant Temperature Oven DNE Series” of Yamato Scientific Co., Ltd.
- This product has not been designed for medical applications. Use this as a laboratory drying sterilizer only.
- In order to use this Equipment properly, please read this Instruction Manual and Warranty Card thoroughly before use. Keep them in safe place close to this Equipment so that you can refer to them any time.

 **Warning:** Please read the important warning notes in this Manual carefully and thoroughly, and get the good understanding of their contents before using this Equipment.

**Yamato Scientific America, Inc.**

Printed on recycled paper

<b>1. Safety Precautions</b> .....	<b>1</b>
Explanation of symbols .....	1
List of symbols .....	2
Warning and Cautions .....	3
<b>2. Before operating the Equipment</b> .....	<b>4</b>
Precautions when installing the Equipment .....	4
<b>2. Before operating the Equipment</b> .....	<b>9</b>
<b>3. Names and functions of each part</b> .....	<b>10</b>
Main unit .....	10
Structure of the main unit .....	12
Structure of the main unit .....	13
Control Panel .....	15
<b>4. Operating procedure</b> .....	<b>16</b>
Prior confirmation .....	16
Date & Time setting .....	17
Buzzer function selection .....	18
Fixed temperature operation .....	20
Auto stop operation .....	24
Auto start operation .....	27
Program operation .....	30
How to copy or delete programs .....	39
About the wait function .....	41
Setting key lock mode .....	42
Calibration offset .....	43
Setting the recovery mode .....	44
Resetting integrated CO2 volume and CO2 emission factor .....	45
Backup data saving / reading out / resetting .....	47
Monitoring data .....	48
Independent Overheat Prevention Device .....	50
<b>5. Handling precautions</b> .....	<b>51</b>
 Warning .....	51
 Caution .....	52
<b>6. Maintenance method</b> .....	<b>57</b>
Daily inspection/maintenance .....	57
<b>7. Long storage and scrap</b> .....	<b>58</b>
When not using the Equipment for a long time / when scrapping .....	58
Matters to consider when scrapping the Equipment .....	58
<b>8. When a trouble occurs</b> .....	<b>59</b>
Message error table .....	59
Troubleshooting .....	60

<b>9. After sales service and warranty</b> .....	<b>61</b>
Request to repair parts. ....	61
<b>10. Specifications</b> .....	<b>62</b>
Specifications .....	62
<b>11. Accessory</b> .....	<b>64</b>
List of accessories .....	64
<b>12. Wiring diagram</b> .....	<b>66</b>
DNE401/601 Wiring diagram .....	66
DNE411/611 Wiring diagram .....	67
DNE811 Wiring diagram .....	68
DNE911 Wiring diagram .....	69
Wiring diagram part symbols. ....	70
<b>13. List of dangerous substances.</b> .....	<b>71</b>
<b>14. Standard setup manual.</b> ..... エラー! ブックマークが定義されていません。	
<b>Attachment : Programming sheet.</b> .....	<b>73</b>

# 1. Safety Precautions

## Explanation of symbols

### About symbols

Various symbols are provided in this Instruction Manual and on the product to ensure safe operation. Improper handling of this Equipment without understanding their contents will lead to the results classified below. Be sure to fully understand the description of symbols below before proceeding to the text of this Manual.

---

 **Warning** Indicates a situation which may result in death or serious injury (Note 1.)

 **Caution** Indicates a situation which may result in minor injury (Note 2) and property damages (Note 3.)

---

(Note 1) Serious injury means a wound, an electrical shock, a bone fracture or intoxication that may leave after effects or require hospitalization or outpatient visits for a long time

(Note 2) Minor injury means a wound or an electrical shock that does not require hospitalization or outpatient visits for a long time.

(Note 3) Property damage means damage to facilities, devices and buildings or other properties.

### Meanings of symbols



This symbol indicates a matter urging user to follow the warning ("caution" included).  
Specific description of warning is indicated near this symbol.



This symbol indicates prohibitions.  
Specific prohibition is indicated near this symbol.



This symbol indicates matters that the user must perform.  
Specific instruction is indicated near this symbol.

# 1. Safety Precautions

## List of symbols

### Warning



General Warnings



Danger!: High Voltage



Danger!: High Temperature



Danger!: Moving Part



Danger!: Explosion Hazard

### Caution



General Cautions



Caution: Electrical Shock!



Caution: Burns!



Caution: Heating Container without water!



Caution: Water Leak!



Caution: For water only



Caution: Toxic Chemicals

### Prohibitions



General Prohibited Actions



No open flame



Do not disassemble



Do not touch

### Compulsions



General Mandatory Actions



Connect grounding wire



Leveled Installation



Disconnect Power



Regular Inspection

# 1. Safety Precautions

## Warning and Cautions

### Warning



**Never operate the Equipment in an atmosphere where flammable or explosive gas is present.**

Never operate this Equipment in an atmosphere where flammable or explosive gas is present. This Equipment is not explosion-proof. It will cause fire/explosion. (Refer to "Chapter 13. List of Dangerous Substances" on P.68).



**Ground always the Equipment.**

Ground always this Equipment properly in order to avoid electric shock due to electrical leakage.



**Turn the power of the controller and the ELB off immediately when you notice any abnormality.**

Turn the power of the controller and the ELB off immediately and unplug Power Cord from outlet or disconnect the breaker of switch board of facilities, If smoke or strange smell is generated from this Equipment by chance. It may cause fire or electrical shock.



**Do not operate at Power Cord/Power Cable bundled state.**

Do not operate at Power Cord/Power Cable bundled state. If it is operated in such a manner, it will overheat, and then cause fire.



**Do not damage Power Cord/Power Cable.**

Do not damage Power Cord/Power Cable by bending, pulling, or twisting with force. It may cause fire or electric shock.



**Never use an explosive or a combustible substance.**

Never use an explosive or a combustible substance or any substances that contain such a substance. Otherwise an explosion or a fire may result.



**Never disassemble nor modify the Equipment.**

Never disassemble nor modify this Equipment. Those actions may cause malfunction, fire or electric shock.



**Never touch high temperature sections.**

Never touch high temperature sections. Some sections of this Equipment are heated during and right after operation. Watch out for getting burned.



**Prohibit to be connected with multiple Power Cords/Power Cables in single outlet.**

May cause heat generation or fire on power line, if multiple Power Cords/Power Cables are connected with extension cord reel or in single outlet. Besides, may drop input voltage to this Equipment, and not keep its performance and proper temperature control.



### Caution



**Turn immediately the power of the controller and the ELB off at thundering.**

Turn immediately the power of the controller and the ELB off at thundering. If not, it may cause fire or electric shock.

## 2. Before operating the Equipment

### Precautions when installing the Equipment

#### 1. Choose proper place for installation



Do not install this Equipment in the place where:

- the location is rough, dirty or un-leveled.
- flammable gas, explosive gas or corrosive gas will be generated.
- ambient temperature will be more than 35°C or less than 5°C.
- ambient temperature will fluctuate.
- there is excessive humidity and dusty.
- there is constant vibration.
- **power supply is instable.**
- Liquid may splash
- there is direct sunlight.
- outside the building.



Install the Equipment(s) at the place with sufficient space as specified as below  
Take special care around the exhaust ports which are located on the ceiling of the main unit for models DNE401/411 and DNE601/611, and at the back of the main unit for models.

#### ① DNE401/411/601/611

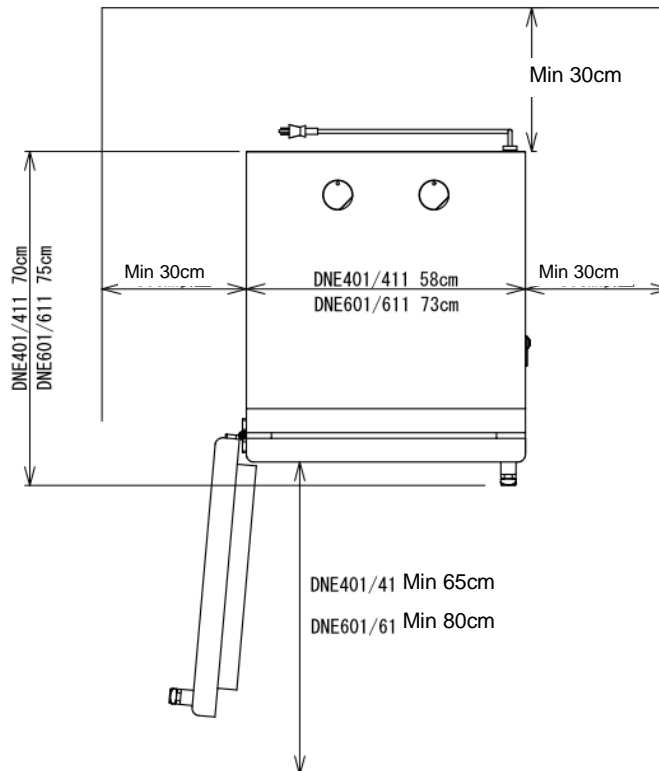

## 2. Before operating the Equipment

### Precautions when installing the Equipment

#### 1. Take care for the place and the environment of installation.



② DNE811

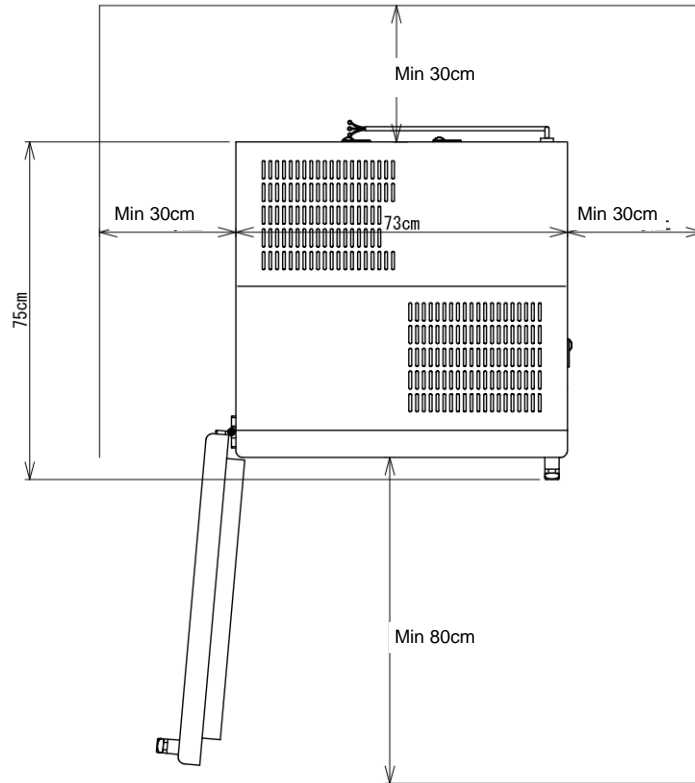

③ DNE911

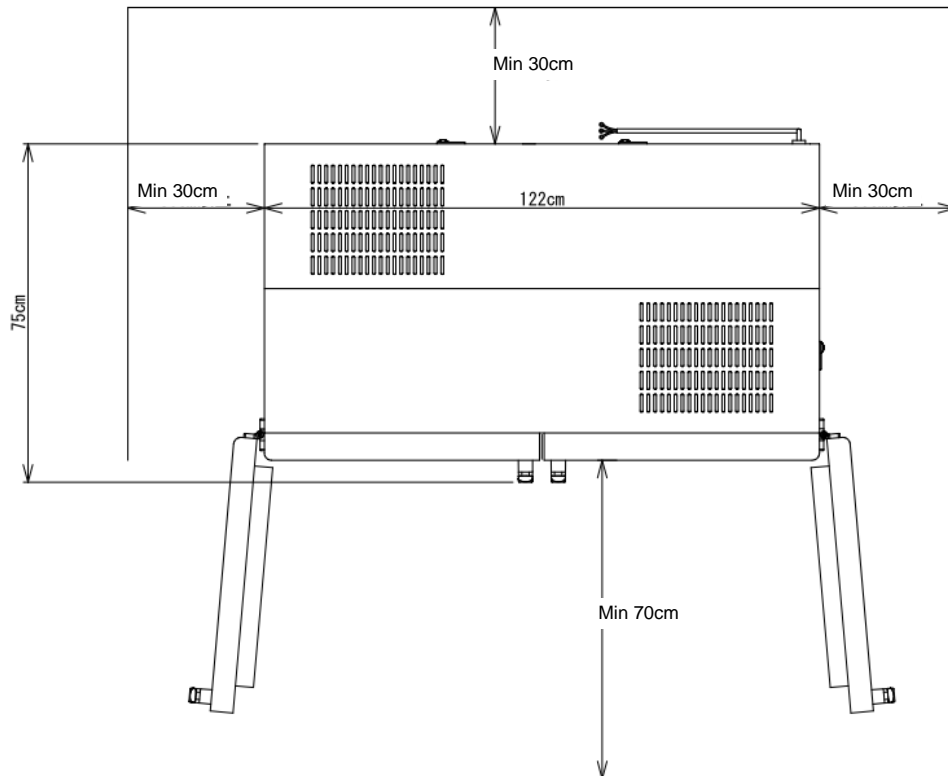



## 2. Before operating the Equipment

### Precautions when installing the Equipment

#### 2. Install the Equipment on leveled location.



Install this Equipment on leveled floor. If it is installed on rough and/or slope floor, vibration or noise will be occurred, and unexpected trouble and malfunction may be happened.



Weight of this Equipment is as follows:

DNE401/411 ; approx. 63 kg、DNE601/611 ; approx. 77kg、DNE811 ; approx. 92kg、  
DNE911 ; approx. 185kg です。

Handle this Equipment carefully by two people at least at the transportation and the installation  
Models DNE811 and DNE911 have caster wheels and adjusters. Make sure that the adjusters  
are lifted before transportation and move only slowly taking care for gaps.

#### 3. Implement safety measures when installing the unit.



May be injured by moved and/or fallen this Equipment down by earthquake and/or unexpected  
impact. Recommend to install this Equipment at the place away from the access door and to take  
other safety steps.

## 2. Before operating the Equipment

### Precautions when installing the Equipment

#### 4. Set the Equipment adjusters. (DNE811, DNE911)

- ❗ Set 2(two) adjusters underneath front bottom of this Equipment.

Set those adjusters by the following procedure after this Equipment installation.

- ① Turn each adjuster until securely sand on the floor.
- ② Check any gap between floor and 4(four) standing points.
- ③ Tighten each nut of its adjuster against to the nut above to prevent loosening.

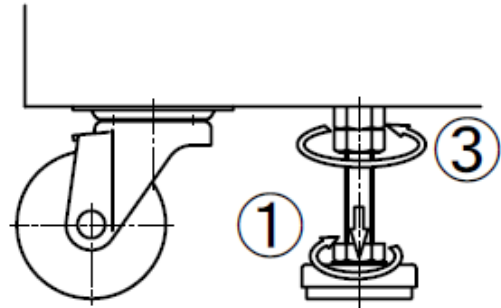

#### 5. Implement appropriate safety measures after installation.

- ❗ May be injured by moved and/or fallen this Equipment down by earthquake and/or unexpected impact.  
Implement appropriate measures against falling down for safety.

#### 6. Ventilate sufficiently for the Equipment

- ⊘ Do not operate the Equipment blocked in the radiating slit holes-Louver on its side and back panels and top panel. Refer to 3. "Name and Functions of each part" on page 8 for the location of Louvers.  
Internal temperature will rise, causing a malfunction of the controller to compromise the performance as well as to cause a possible accident or a fire.

#### 7. Do not operate at the location of liquid splashing.

- ⊘ Do not operate this Equipment at the location of liquid splashing. If Controller of this Equipment will be wetted by splashing any kind of liquid, it may cause accident, controller malfunction, electrical shock and/or fire.

#### 8. Never operate in an atmosphere where flammable or explosive gas is present.

- ⊘ Never operate this Equipment in an atmosphere where flammable or explosive gas is present. This Equipment is not explosion-proof. Spark may be discharged by switching Earth Leakage Breaker (ELB) "ON ( | )" and "OFF (O)" and also relay during operation, and then it may cause fire or explosion. See Chapter 13. "List of Dangerous Substances" for flammable and explosive gases on page . 64

#### 9. Connect Power Cord/Power Cable to receptacle or switch board of facilities.

- ❗ Connect Power Cord/Power Cable to suitable receptacle/switch board of facilities according to electrical requirements as follows.

Electrical requirements:	DNE401	AC115V single phase 50/60Hz	10A or more (ELB capacity ; 15A)
	DNE411	AC220V single phase 50/60Hz	5. 5A or more (ELB capacity ; 10A)
	DNE601	AC115V single phase 50/60Hz	11A or more (ELB capacity ; 15A)
	DNE611	AC220V single phase 50/60Hz	6A or more (ELB capacity ; 10A)
	DNE811	AC220V single phase 50/60Hz	11. 5A or more (ELB capacity ; 15A)
	DNE911	AC220V single phase 50/60Hz	14A or more (ELB capacity ; 20A)

The operational voltage range is  $\pm 10\%$ , the voltage range where the specified performance is guaranteed is rating  $\pm 5\%$ , the frequency is rating  $\pm 1\%$ .

※ Check line voltage of its receptacle/switch board of facilities and/or whether utilize the same line with other equipments or not, if this Equipment does not start up/operate even to turn Earth Leakage Breaker(ELB) On( | ). Take correct action for the solution, such as changing its power source away from other equipment.

May drop input voltage to this Equipment and cause to degrade its heating and also temperature control performance, if multiple power plugs/power cables are connected with single outlet.

## 2. Before operating the Equipment

### Precautions when installing the Equipment

#### 10. Take care when connecting the power cord. (DNE411, DNE611, DNE811, DNE911 AC220V specification)

- !** These models are designed to operate at single-phase AC220V. Ask your dealer or an electrical technician for connection work of the power cord.  
Connection requires professional knowledge and skills. A fire or an electrical shock may result if an unqualified person performs this work.

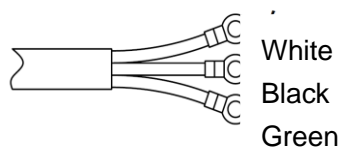

Core color	Wiring on the distribution board
White	Ground side
Black	Voltage side
Green	Earth

#### 11. Must connect grounding wire properly.

- ⊘** Never operate this Equipment at bundled Power Cord/Power Cable. May heat its Cord/Cable and then cause fire, if operate at bundled it.  
Do not modify, bend forcibly, twist or pull Power Cord/Power Cable. Otherwise, may cause fire and/or electrical shock.  
Do not damage Power Cord/Power Cable by setting under any desk and/or chairs, or by pinching it between objects. Otherwise, may cause fire and/or electrical shock.  
Do not place Power Cord/Power Cable close to kerosene heater, electric heater, or other heat-generating devices.  
Insulation of Power Cord/Power Cable may burn and cause fire or electrical shock.
- !** Turn immediately off Earth Leakage Breaker (ELB) and also disconnect Power Plug/breaker of switch board of facilities, if it is damaged such as exposure of core wire or disconnection.  
May cause fire or electrical shock, if this Equipment is operated with damaged Power Cord/Power Cable.  
Ask local dealer to replace Power Cord/Power Cable.  
Connect Power Cord/Power Cable to appropriate receptacle or switch board of facilities.

#### 12. ( 1 ) Must connect grounding wire properly. ( DNE401 , DNE601 AC115V specification)

- ⊕** • Must connect grounding wire properly to grounding line or terminal in order to avoid electrical shock due to electrical leakage.
- ⊘** • Never connect grounding wire to gas line pipe or water line pipe due to fire or electrical shock.  
• Never connect grounding wire to telephone grounding line or to lightning conductor due to fire or electrical shock.  
• Never connect multiple plug to single receptacle due to generating heat dangerously.

Connect to grounded receptacle.

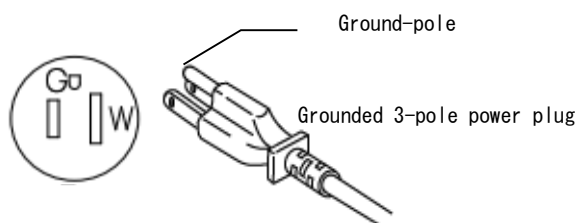

Receptacle with ground connection

## 2. Before operating the Equipment

### How to install and preparation before operation

#### 12. (2) Must connect grounding wire properly. (DNE411, DNE611, DNE811, DNE911 AC200V specification)



• Require to ground by Electrical Equipment Technical Standards Section 19-class D (Grounding Resistance Max. 100 Ω) in Japan, if grounding terminal is not provided. Please contact with local dealer, local electrician, or Yamato Customer Service Center.



• Connect the terminals firmly to switch board of facilities or appropriate power plug.  
 • Power plug itself will not be included as an accessory of this Equipment. Connect to the power supply facilities that meet the electric capacity.

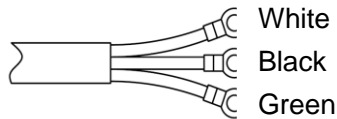

Core color	Wiring on the distribution board
White	Ground side
Black	Voltage side
Green	Earth



Never connect grounding wire to gas line pipe, water line pipe or telephone grounding wire due to fire or electric shock.

#### 13. Never disassembly nor modify the Equipment.



Never disassemble nor modify this Equipment. Those actions may cause this Equipment malfunction, fire or electric shock.

#### 14. Installation of shelf boards and samples (Do not put samples directly on the bottom of the chamber.)



The models DNE401/411 and DNE601/611 have two shelf boards, the model DNE811 has four boards and the model DNE911 has eight boards.

One of those boards (two for DNE911) is (are) screwed to the lowest shelf rung on the shelf pillar inside at the time of factory shipping.

Put other shelf boards to places you want in the bath.

There is a heater below the rectifying plate, which causes the temperature on and around the plate is always higher than the set temperature. Placing a specimen on the rectifying plate directly may damage the specimen or cause an accident from a high temperature.

If a specimen clogs the suction port of the rectifying plate, proper temperature control will be hampered and burning of specimens or a fire may result from an abnormal temperature. Be sure to place specimens on a shelf board and never attempt to place them directly on the rectifying plate.

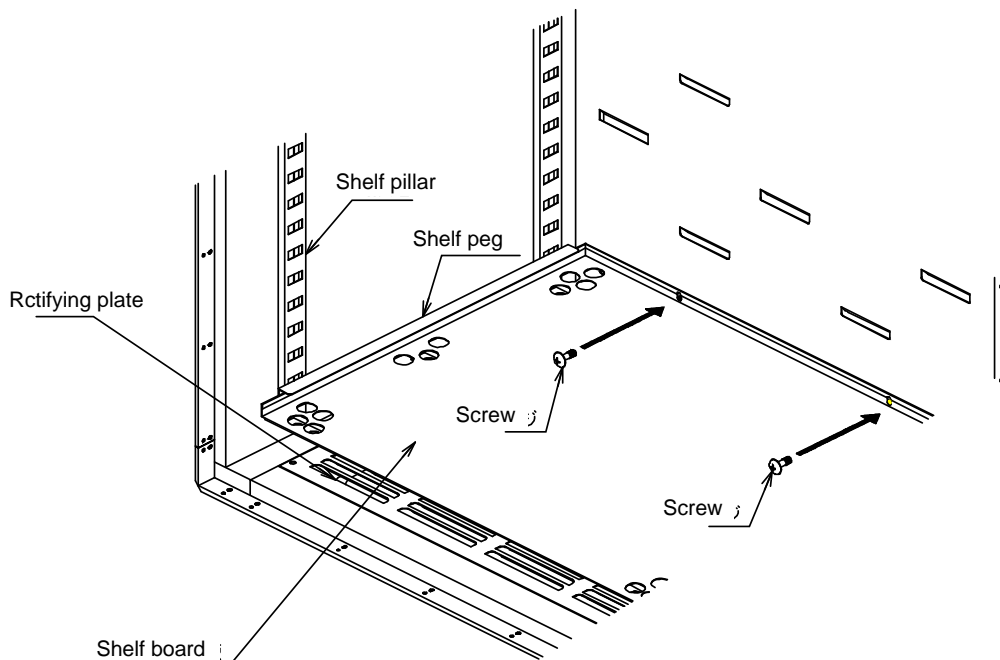

### 3. Names and functions of each part

Main unit

External view (DNE401/411、DNE601/611)

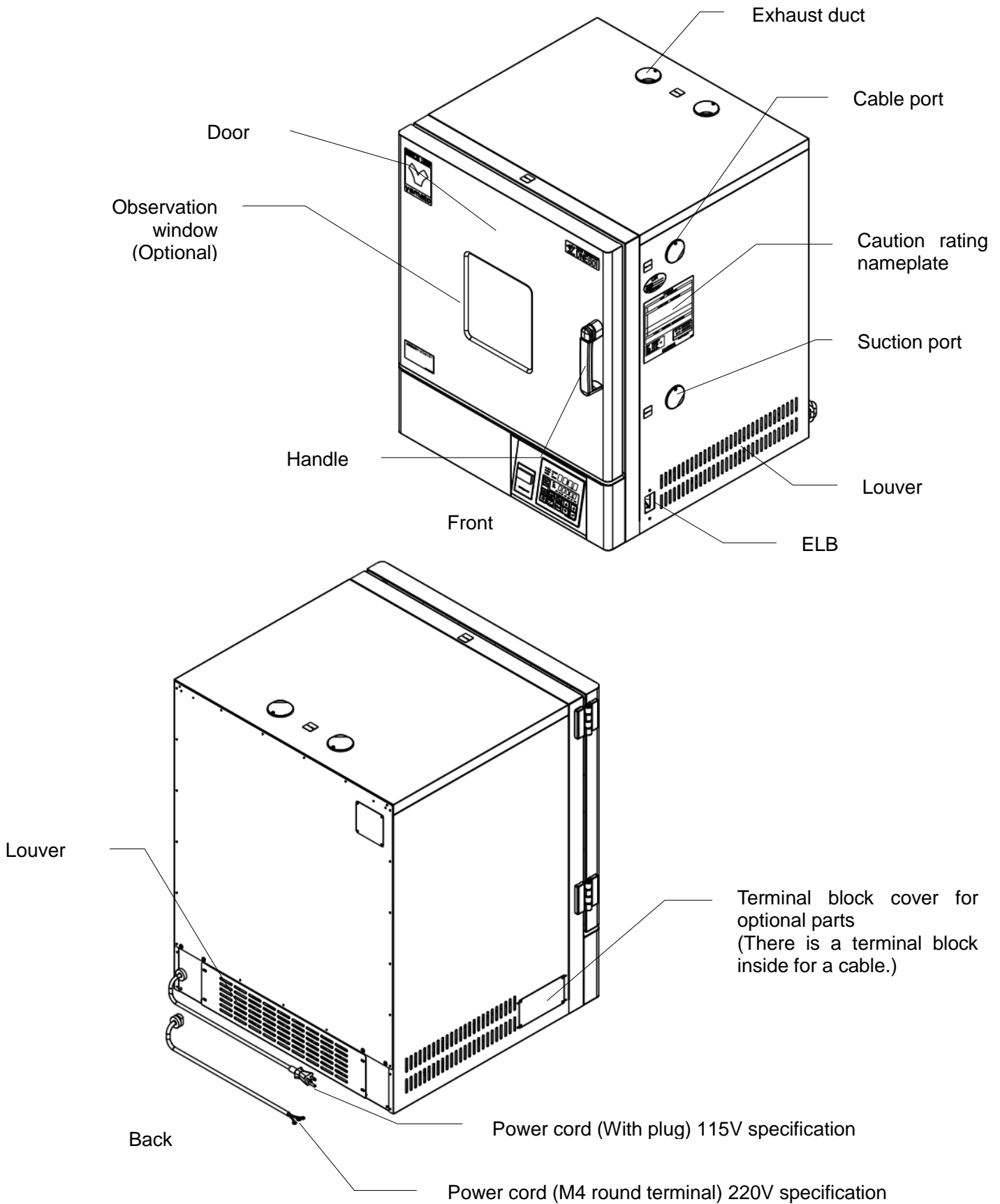

# 3. Names and functions of each part

## Structure of the main unit

### External view (DNE811)

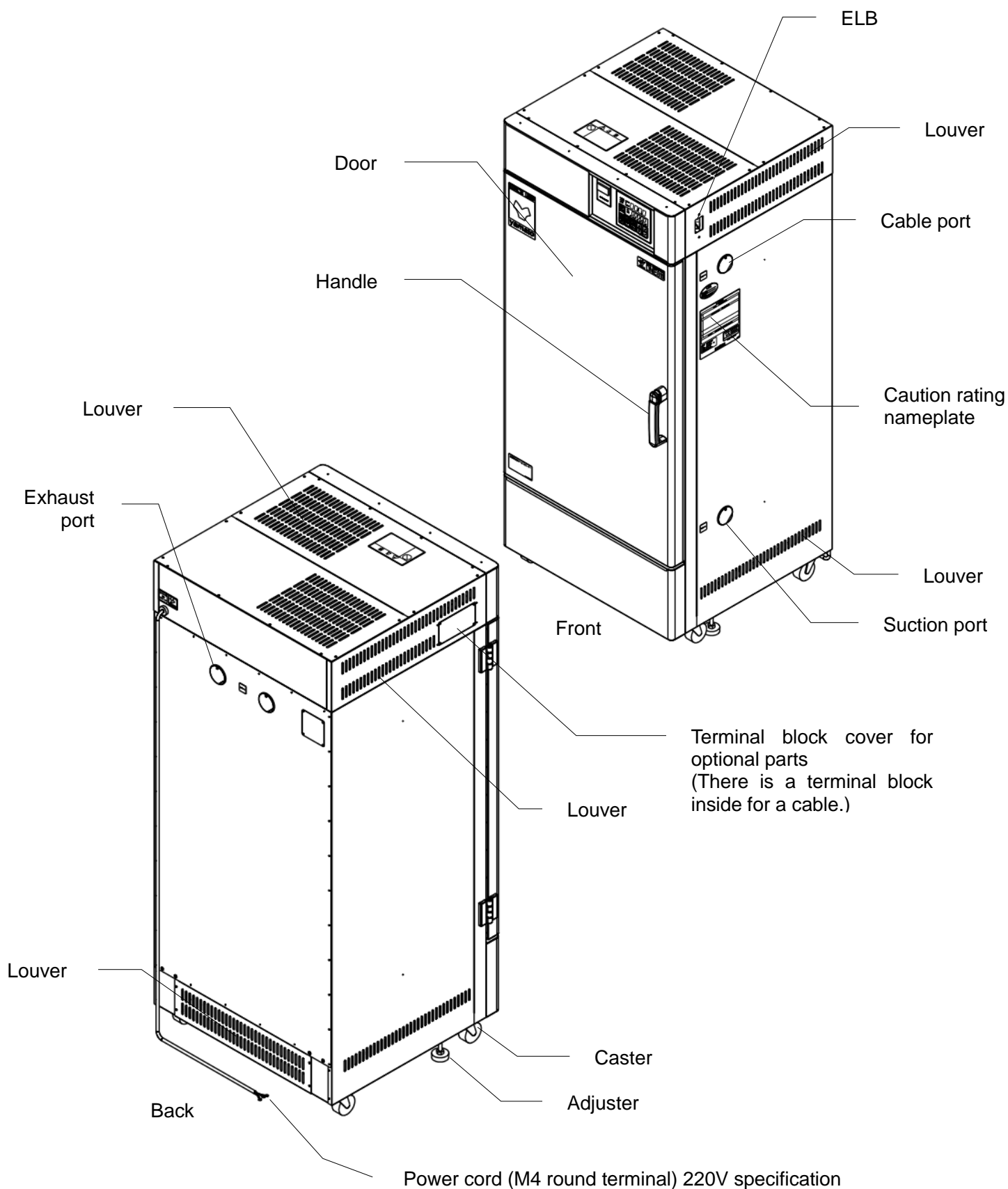

# 3. Names and functions of each part

## Structure of the main unit

External view (DNE911)

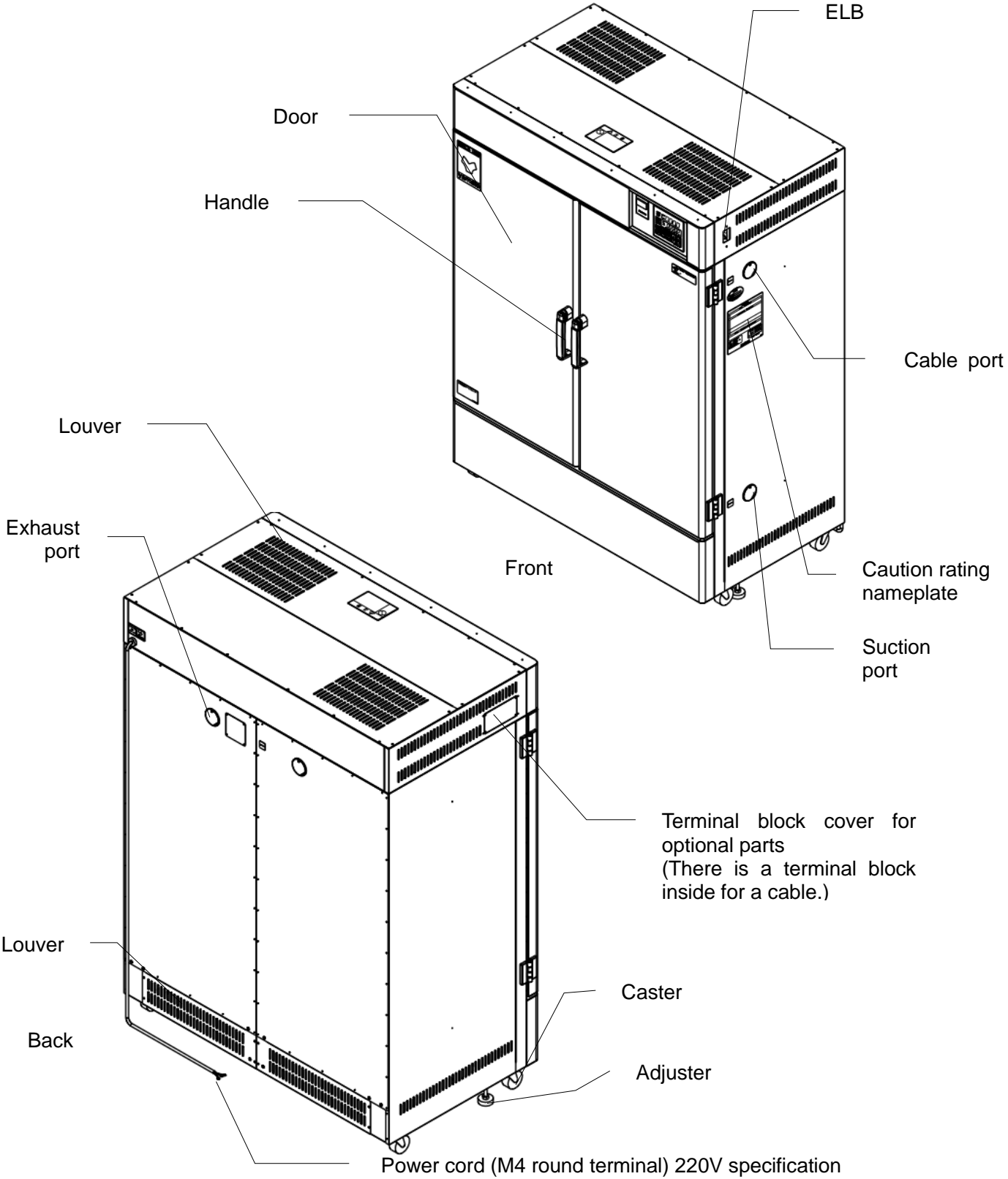

# 3. Names and functions of each part

## Structure of the main unit

DNE401/411/601/611

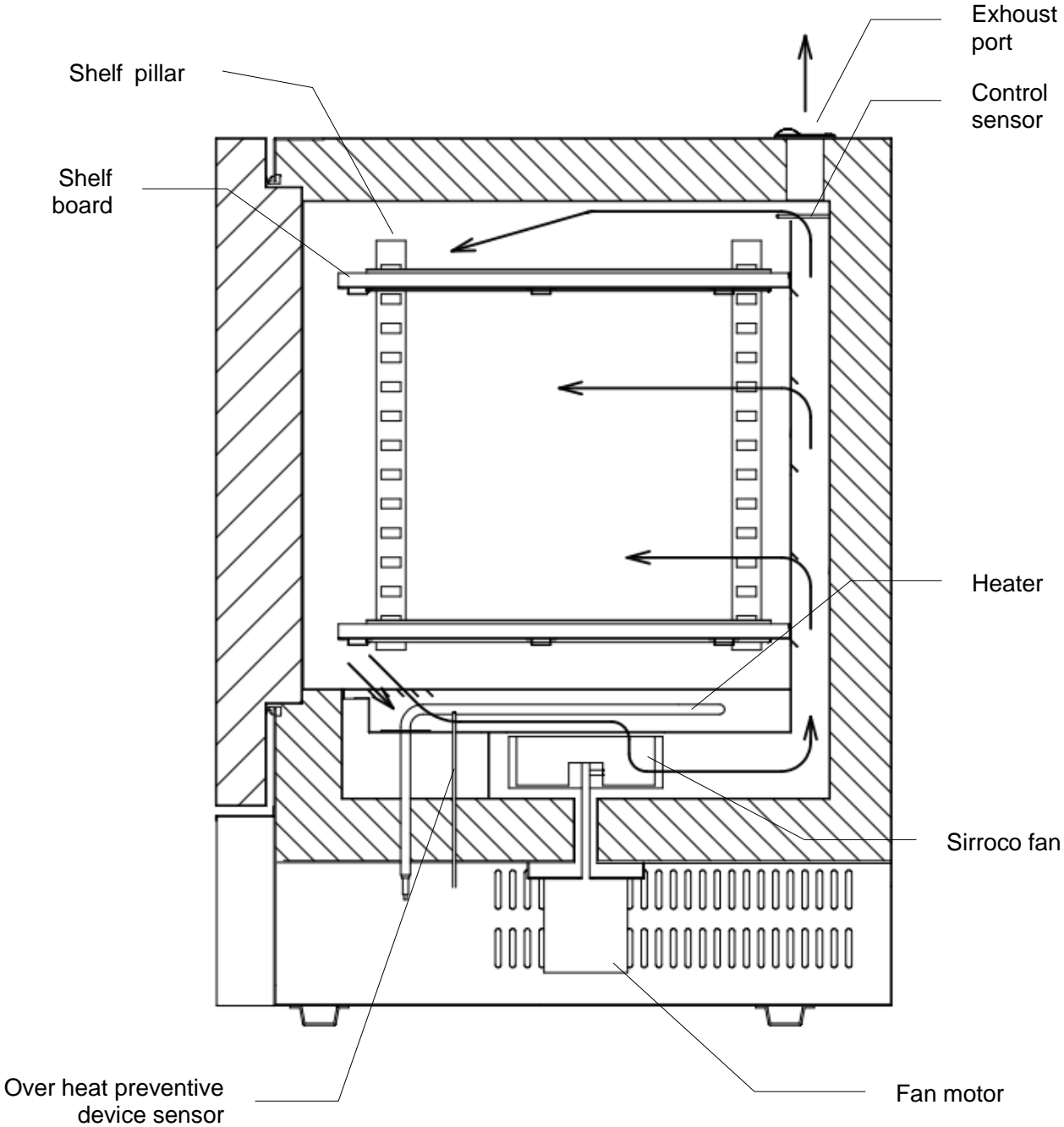



# 3. Names and functions of each part

## Structure of the main unit

DNE811/911

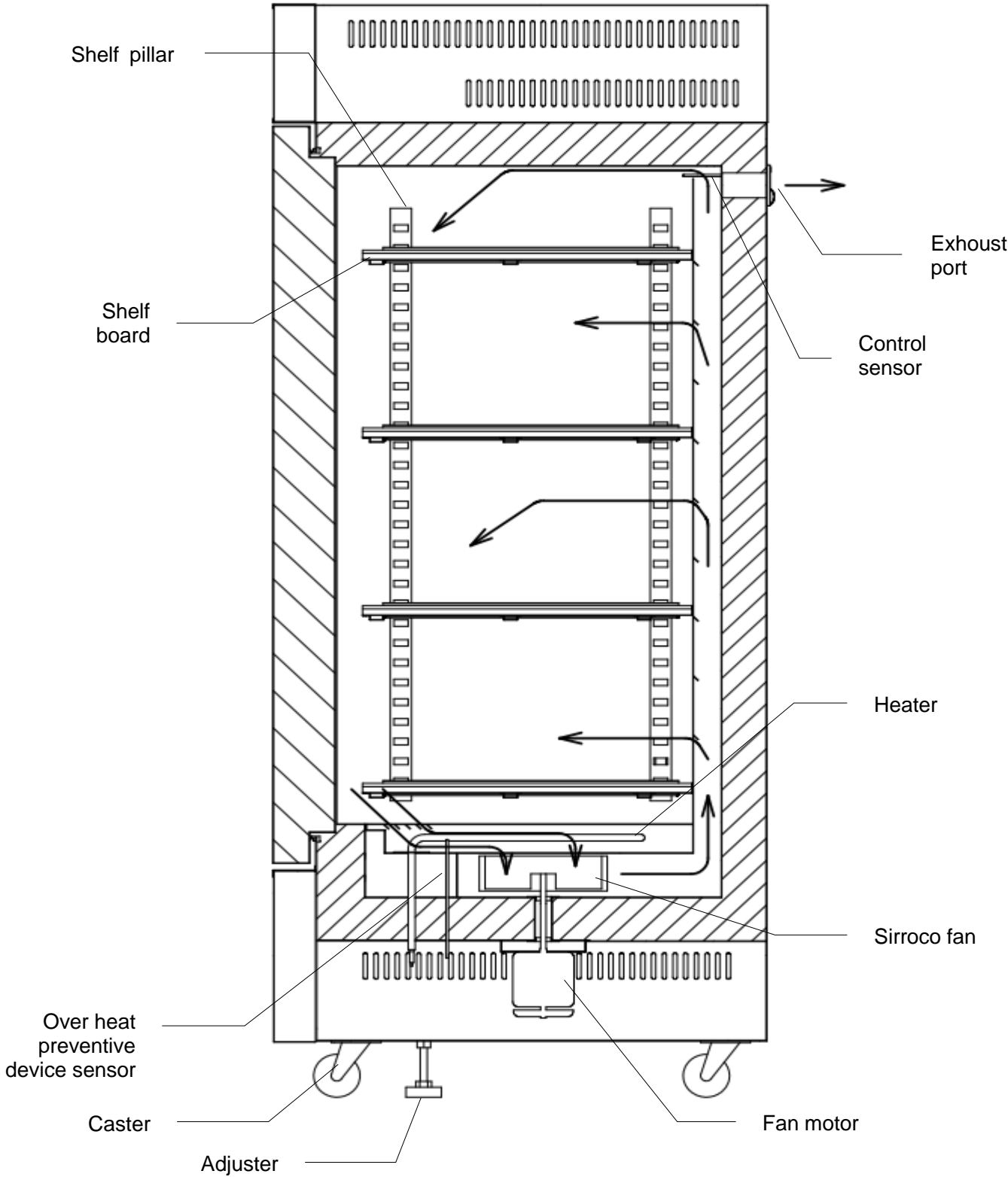

### 3. Names and functions of each part

#### Control Panel

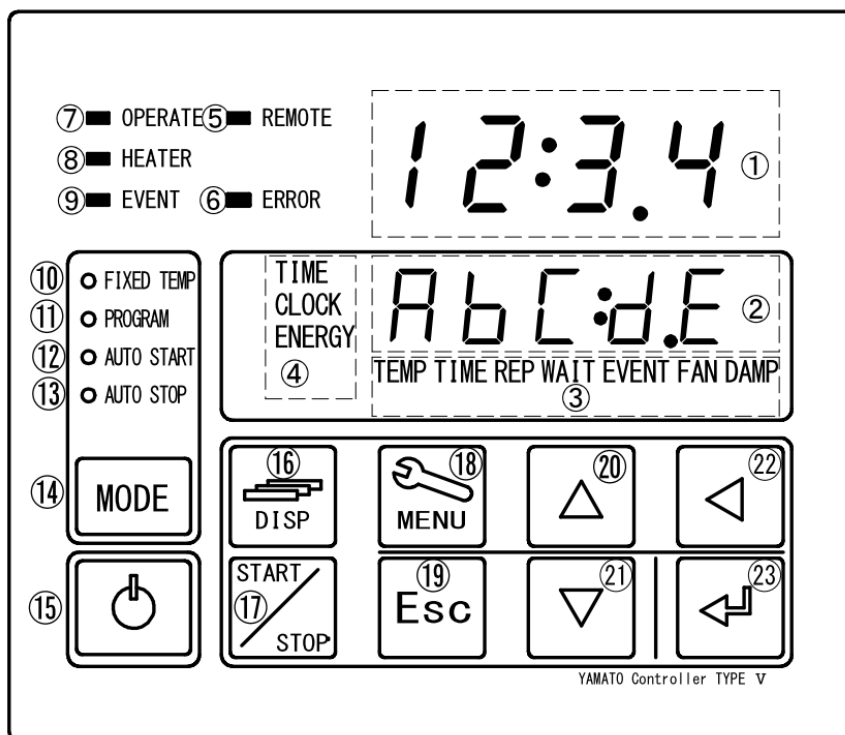

No	Name	Description
1	Top screen	Display read temperature in Chamber and error numbers.
2	Bottom screen	Display target temperature and various information.
3	Program setting item display	Illuminate one of lamps selected from different settings.
4	Comes on during duration/time setting and in the Monitoring mode	Illuminate one of lamps selected from 3(three) different settings.
5	REMOTE Lamp	Illuminate during control via communication
6	ERROR Lamp	Illuminate this Lamp at each error occurred.
7	OPERATE Lamp	Illuminate this Lamp during operation, and flash it during operation standby mode.
8	HEATER Lamp	Flashes or lights while the heater is live according to the operation amount.
9	EVENT Lamp	Illuminate this Lamp at Event Output setting(option).
10	FIXED TEMP Lamp	Illuminate while the fixed temperature operation mode is selected.
11	PROGRAM Lamp	Illuminate in the Program operation mode.
12	AUTO START Lamp	Illuminate in the Auto start mode.
13	AUTO STOP Lamp	Illuminate in the Auto stop mode.
14	MODE key	Use at changing Operation Mode among No. 10 thru. No.13(⑩~⑬ on the Panel).
15	Controller POWER key	Turn "Idle State"-(Controller is sleeping) or "Standby State"-(Controller is awaking) of Keys(except ⑩MENU Key) by pressing and holding this key.
16	DISP key	Keep this key pressed longer to execute the Monitoring function. This key functions as the back key for setting items while any of setting menus displayed.
17	START/STOP key	Use to start selected operation or to stop working operation.
18	MENU key	Use to set target program, click on/off, output temperature range(option), and etc.
19	Esc key	Use to abort or get out of working menu without entering and/or editing set value and items.
20	▲(Up) key	Use to change set value up.
21	▼(Down) key	Use to change set value down.
22	◀ key	Used as the Left key for the setting digits (cursor) during setting.
23	ENTER key	Use to enter set value and items.

## 4. Operating procedure

Prior confirmation

### 1. Check the power supply and the ground wire.



Make sure to connect with this Equipment Power Cord/Power Cable to appropriate power source and to ground definitely.

### 2. Check the ELB.



Check if the ELB functions properly.  
See "Maintenance method" on P.57 Chapter 6.  
Check ELB performance once a month or before continuous long-term operation.  
Tick current time on Bottom Screen of Control Panel at ELB ON( | ).

### 3. Check the Independent Overheat Preventive device.



Make sure to set IOPD temperature more than 30°C higher of Target Temperature in Chamber.  
Check IOPD performance before continuous long-term operation. Refer to "Independent Overheat Prevention Device" on page 50.

### 4. About the handling of the exhaust port



When you use the exhaust port on the ceiling of the main unit (on the rear for the models DNE811 and DNE911), open the suction port at the lower point on the right side of the unit.  
Take extreme care when opening or closing the exhaust or the suction ports, both of which will be hot and may cause a burning.







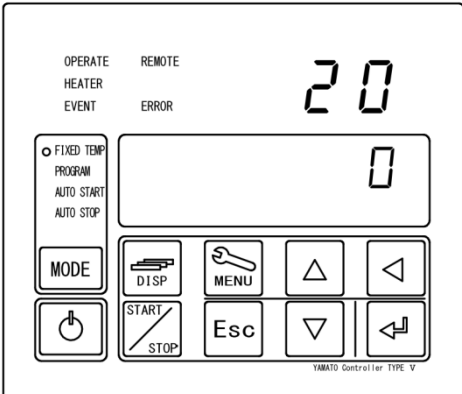

# 4. Operating procedure

## Date & Time setting

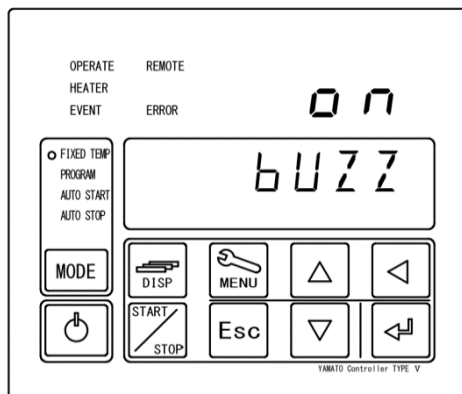
The controller of this product keeps backup memory for customer settings including the calendar, timer settings, or operation programs using the built-in battery. This battery will hold data for about five years even if you turn power of the unit off. (Battery life will change depending on specific operating conditions.)





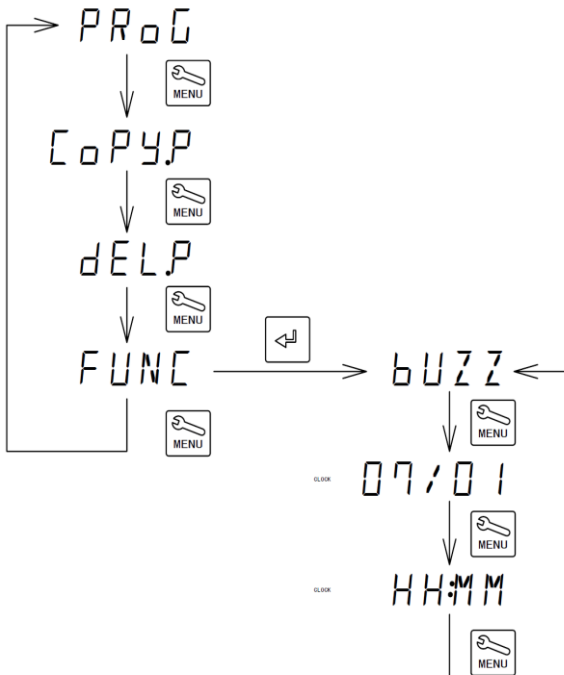





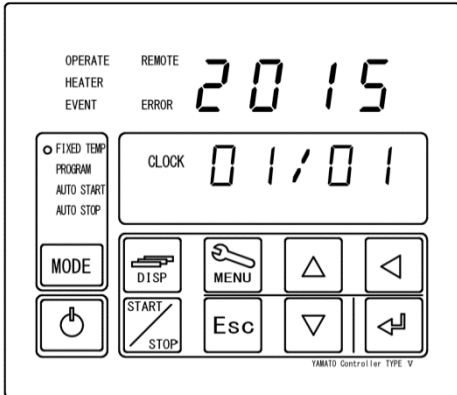



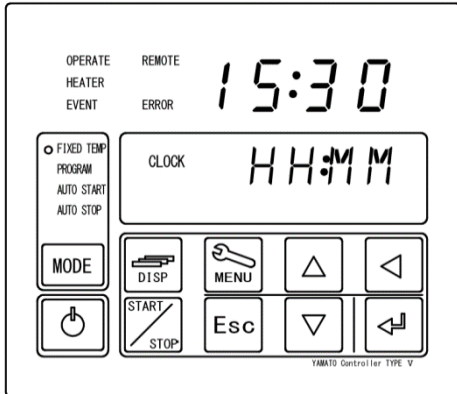

※ Contact with Yamato local dealer or Yamato Customer Service Center in case of replacing this battery. Make backup data file of the existing program data in case of being processed program mode. See “Backup data saving/reading out/resetting” on page 44.

Set up date & time properly in accordance with local time after replacing with new battery.







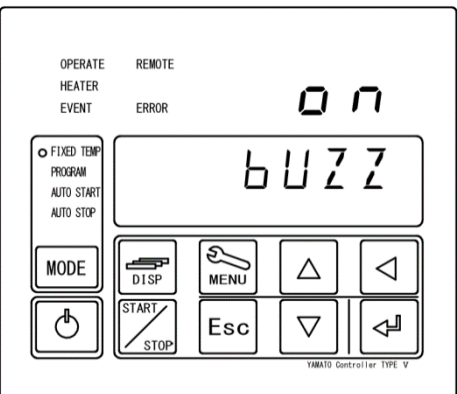

<p><b>1 Turn on power.</b></p> 	<p>Turn on (   ) Earth Leakage Breaker(ELB) on the right side of this Equipment. Bottom Screen of the controller indicate clock time. This is “Idle State” of this Equipment.</p> <p>Press and hold  key to display standby screen. This is “Standby State” of this Equipment.</p> <p>Indicate read temperature in Chamber on Top Screen and indicate target temperature on Bottom Screen. The fan motor will start.</p>
<p><b>2 Display year/month/date and time on each Screen by MENU key.</b></p> 	<ol style="list-style-type: none"> <li>① Press  key.</li> <li>② Press  key few times until [FUNC] is indicated on Bottom Screen and then press  key.</li> <li>③ Press  key to display year on Top Screen and month/date/time on Bottom Screen, When Bottom Screen show [BUZZ].</li> </ol> <p>The  key can be used to reverse the process.</p> 

# 4. Operating procedure

## Date & Time setting

<p><b>3 Set up year and month/date.</b></p> 	<p>Set up year/month/date and clock time.</p> <ol style="list-style-type: none"> <li>① Flash CLOCK lamp. Year and month/date are displayed on Top and Bottom Screen respectively.</li> <li>② Press  key.</li> <li>③ Set calendar year with   keys and then press  key.</li> <li>④ Set month/date with   keys and then press  key.</li> </ol> <p>※ Press  key to shift setting position.</p>
<p><b>4 Set up clock time (described according to 24-hour time).</b></p> 	<ol style="list-style-type: none"> <li>① Press  key.</li> <li>② Press  key, set clock time with   keys, and then press  key. Enter clock time in accordance with 24-hour time.</li> </ol> <p>※ Press  key to shift setting position.</p> <ol style="list-style-type: none"> <li>③ Press  key twice to get back to initial screen after completion of those settings.</li> </ol>

## Buzzer function selection

<p><b>1 Select buzzer function.</b></p> 	<ol style="list-style-type: none"> <li>① Press  key and  key to display [bUZZ] on Bottom Screen with same process of clock time setting described in [2], and then press  key.</li> <li>② Select one from three types of buzzer function with   keys and then press  key. <ul style="list-style-type: none"> <li>ON: Activate clicking sound for all keys and beeping sound for alarm. (Set "on" initially at Factory shipment)</li> <li>CLF :Activate only clicking sound for "Controller POWER key and ENTER key", and beeping sound for alarm.</li> <li>OFF: Deactivate clicking sound for all keys.</li> </ul> </li> </ol> <p>※ The buzzer will sound when an error occurs even if you set "bUZZ" to a setting other than ON.</p> <ol style="list-style-type: none"> <li>③ Press  key twice to get back to initial screen after completion of those settings.</li> </ol>
---	---



# 4. Operating procedure

## Fixed temperature operation

FIXED TEMP(Fixed Temperature) mode is to keep running at target temperature. It will keep running until operation stops.

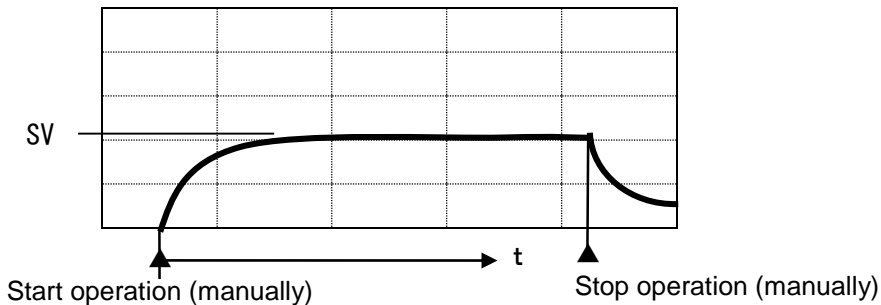

SV: Set Value (Target Temperature), t : Time

### Set Fixed Temperature mode.

#### 1 Turn on the controller.

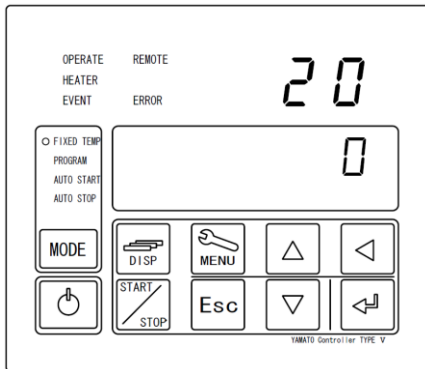

Turn on Earth Leakage Breaker(ELB) on ( | ) the left side wall of this Equipment. (**Idle State**)

Press and hold key to turn on the controller power. (**Standby State**)

Indicate read temperature in Chamber on Top Screen and indicate target temperature on Bottom Screen. The fan motor will start.

#### 2 Select Fixed Temperature Operation.

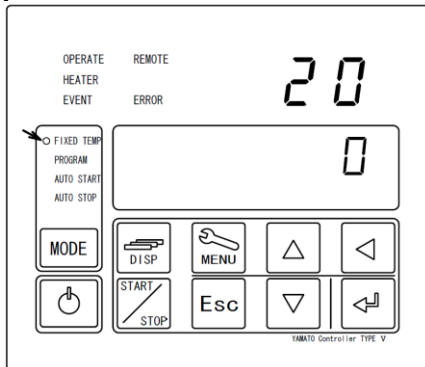

Press key to turn FIXED TEMP (Fixed Temperature mode) lamp on.

※ Fixed Temperature mode would be selected at first time operation. After that, most latest operated mode is selected.

#### 3 Set target temperature.

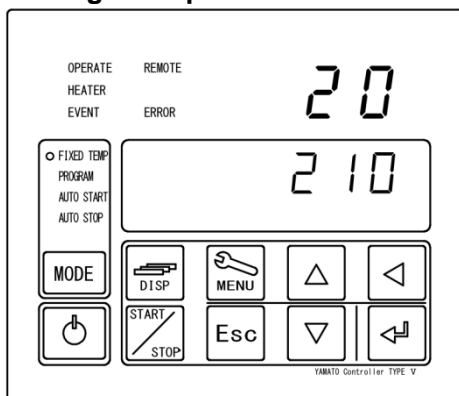

① Press key. Then flash changeable digits on Bottom Screen.

② Shift to flashing digit with key and then change to desired digit with keys.

Operating Temperature Range : 0~220°C

③ Press key when target temperature setting has completed.

Press key once or twice to cancel its setting.

# 4. Operating procedure

## Fixed temperature operation

### 4 Starting operation

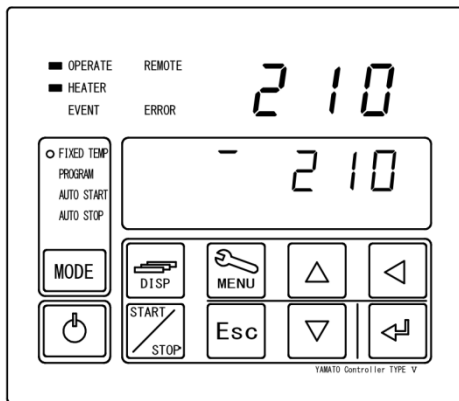
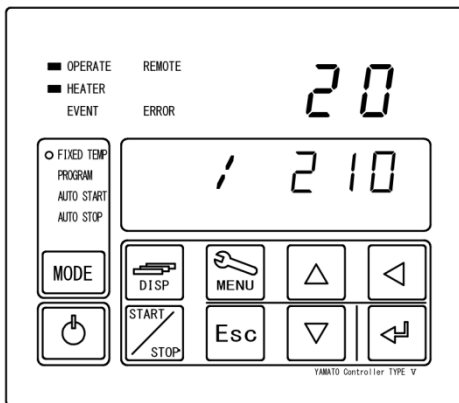

Use the  key to start operation.

The OPERATE (operating) lamp and the HEATER (heater) lamp will come on and temperature control starts.

※ Bottom screen during heating

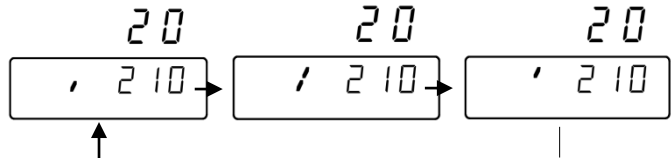

※ Bottom screen while temperature is stable

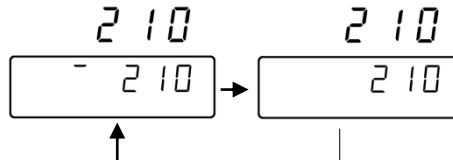

※ Bottom screen while temperature is decreasing

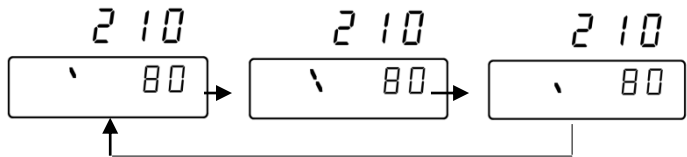

### 5 Stopping operation

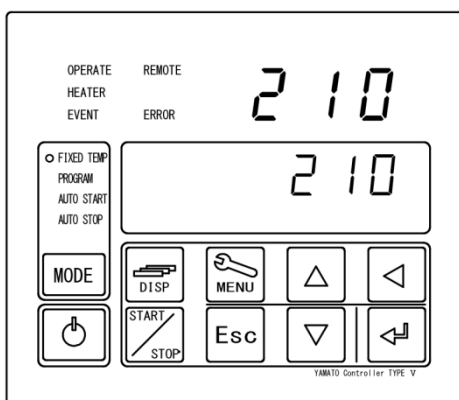

Use the  key to manually stop operation.

The screen will return to the one before starting operation when you stop operation.

※ The fan motor keeps operating even operation is stopped. Press the  key longer to turn the controller power off to stop the fan motor.



# 4. Operating procedure

## Fixed temperature operation

### 6 Stop running Fixed Temperature Operation with timer setting. (Quick Automatic Stop Function)

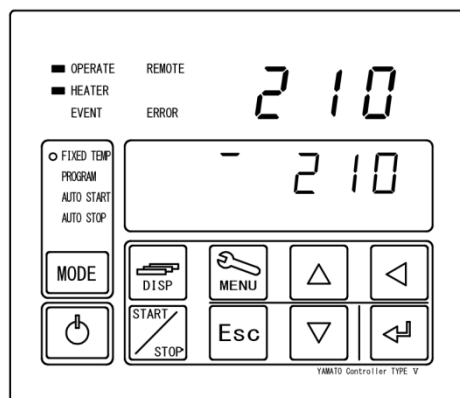
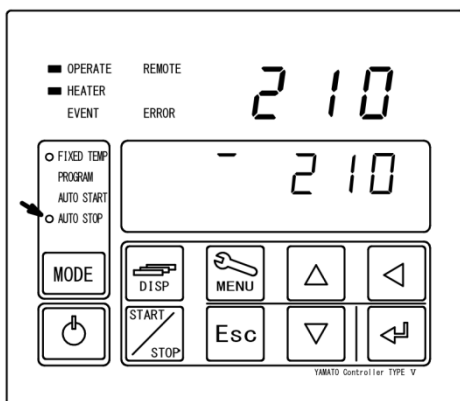
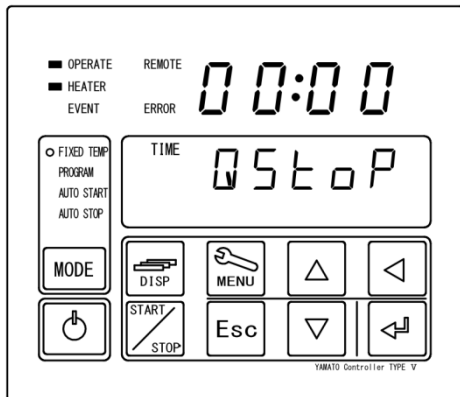

Quick Automatic Stop Function is to stop automatically running Fixed Temperature Operation.

- ① Press **MODE** key at running Fixed Temperature operation.
- ② Show **[QSTOP]** on Bottom Screen and start **[TIME]** lamp flashing on the left top of Bottom Screen.
- ③ Select the method to stop from **TIME/CLOCK** with **△** **▽** key and then press **↵** key.
- ④ Set **TIME** (capable setting range: 0~99hr : 59min) or **CLOCK** (according to 24-hour time) on Top Screen and then press **↵** key.

#### Example 1. Setting time to stop:

Operation is stopped automatically in 35 hours and 30 minutes once temperature reached to target temperature.

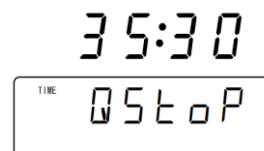

#### Example 2. Setting clock time to stop:

Operation is stopped automatically at 15:00.

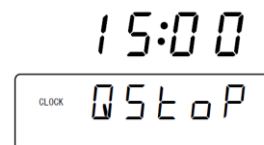

- ⑤ The **AUTO STOP** (Auto Stop) lamp comes on and the Auto Stop function starts.

①

※ You can use the **DISP** key to check the remaining operation time/stop time information on the Bottom screen.

※ Screen to check the remaining operation

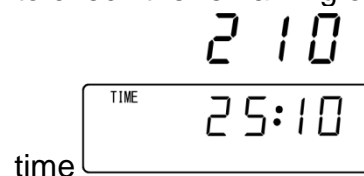

※ Screen to check the operation stop time

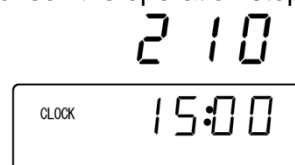

Press the **DISP** key again or wait for about 10 seconds to return to the original status.

## 4. Operating procedure

### Fixed temperature operation

The diagram illustrates the YAMATO Controller TYPE V interface in two states. The top panel shows the 'END' state, where the main display displays '210' and the secondary display displays 'END'. The bottom panel shows the '210' state, where the main display displays '125' and the secondary display displays '210'. Both panels feature a control panel with buttons for MODE, DISP, MENU, and navigation keys (up, down, left, right), along with a START/STOP key and an Esc key. The interface also includes status indicators for OPERATE, HEATER, EVENT, REMOTE, and ERROR.

⑥ When the set time duration elapses or the time comes, the Bottom screen will indicate [END] and operation will stop.

⑦ Use the  key to eliminate the [END] indication.

※ When you stop operation, the screen will return to the one before starting operation.

※ The fan motor keeps operating after operation has been stopped. Press the  key longer to turn the controller power off to stop the fan motor.

# 4. Operating procedure

## Auto stop operation

**This operation mode is used to automatically stop operation by setting the timer.**

The operation mode where operation is automatically stopped by setting an operation duration.(when you set an operation duration)

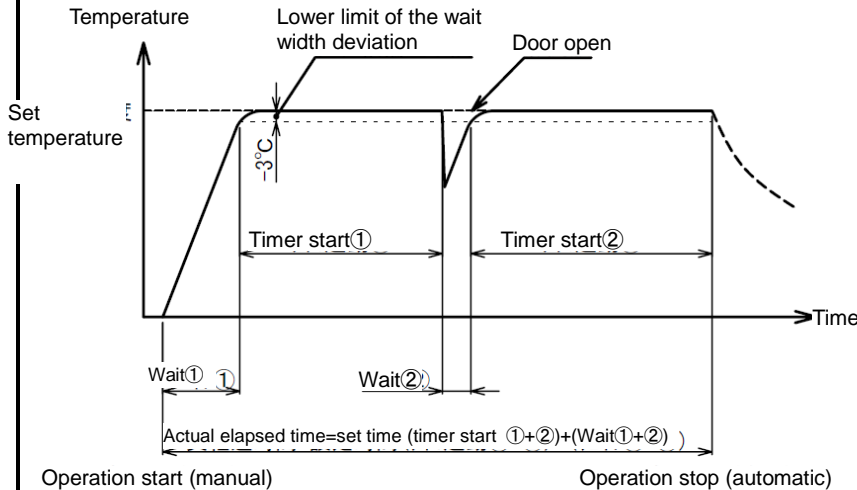

※ When you set a time, the wait function will be activated, the mode will remain “waiting” without counting down the time until temperature indication will be within the wait deviation range between -3°C and +6°C to the set temperature. Counting down starts when the temperature in the chamber reaches the temperature -3°C (indication) to the set temperature.

Even if the temperature in the chamber (indication) the mode will be “waiting” if the lower limit of the wait width deviation is exceeded and time counting down will not occur until the temperature in the chamber (indication) returns.

Operation mode where operation stops automatically at the set time (when an operation time is set)

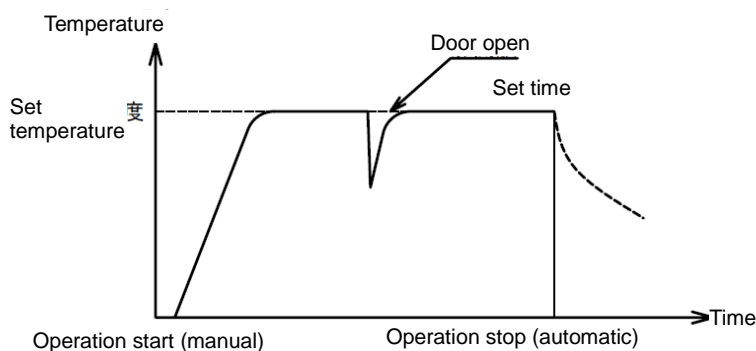

※ The wait function will not work if you select a time setting. Operation will stop when the set time comes. The time you can set is up to 24 hours from the present time.

When a power failure occurred before the set time and continued after that and then the unit recovered automatically, operation will continue to the next set time so remember to stop operation manually.

### Set Automatic Stop mode

#### 1 Turn on the controller

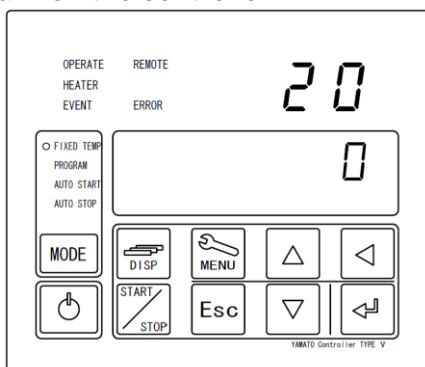

Turn on ( | ) Earth Leakage Breaker (ELB) on the upper right side wall of this Equipment. (**Idle State**)

Press and hold  key to turn on the controller power.

Indicate circulating liquid temperature in Chamber on Top Screen and indicate target temperature on Bottom Screen.

The fan motor will start.

# 4. Operating procedure

## Auto stop operation

### 2 Selecting Automatic stop Operation

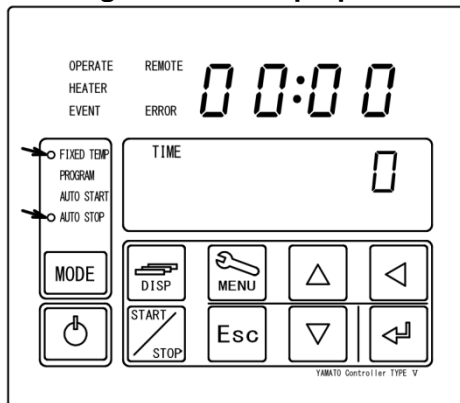

Press **MODE** key to turn FIXED TEMP (Fixed Temperature mode) and AUTO STOP (Automatic Stop mode) lamp on.

※ Fixed Temperature mode would be selected at first time operation. After that, the latest operated mode is selected.

### 3 Set target temperature and operation running time / clock time to stop.

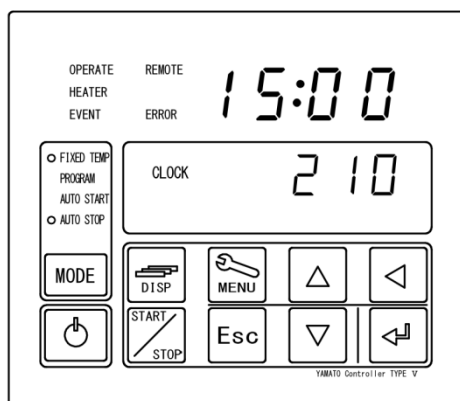
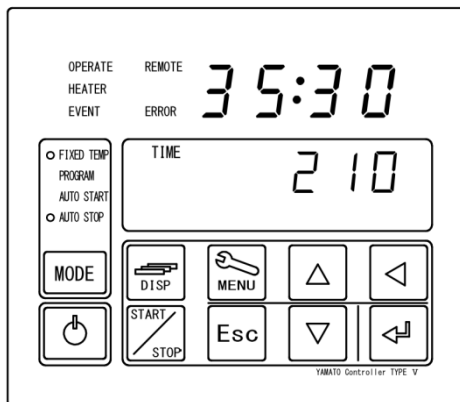

① Press **←** key.

Select stop method from TIME/CLOCK with **△** **▽** keys and then press **←** key.

② Set TIME (capable setting range: 0~99hr : 59min) or CLOCK (according to 24-hour time) on Top Screen and then press **←** key.

③ Set target temperature on Bottom Screen and then press **←** key.

#### Example 1. Setting running time:

Operation is stopped automatically in 35 hours and 30 minutes once temperature reached to 210 °C of target temperature.

#### Example 2. Setting clock time to stop:

Start operation and reach to 210°C in Chamber of target temperature, and operation is stopped automatically at 15:00.

# 4. Operating procedure

## Auto stop operation

### 4 Starting operation

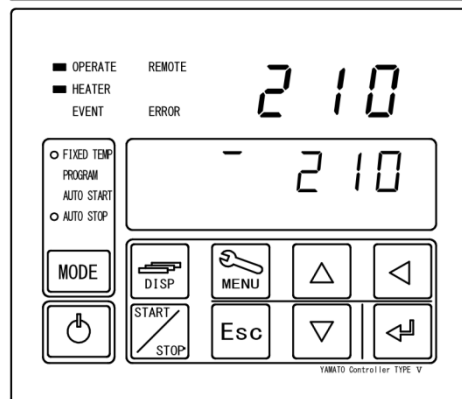
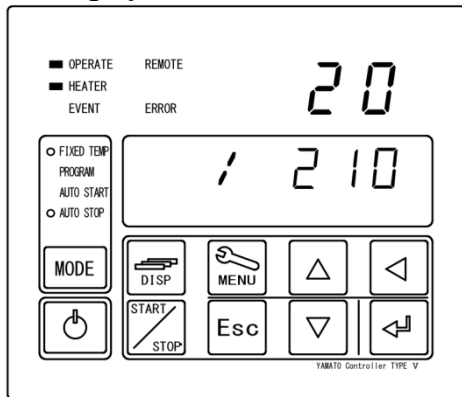

Use the  key to start operation.

The OPERATE (operating) lamp and the HEATER (heater) lamp will come on and temperature control starts.

※ You can use the  key to check the remaining operation time/stop time information on the Bottom screen.

※ Screen to check the remaining operation time

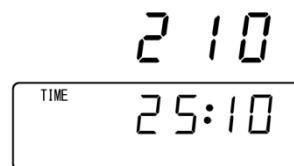

※ Screen to check the operation stop time

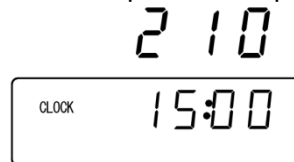

Press the  key again or wait for about 10 seconds to return to the original status.

### 5 Cancelling operation

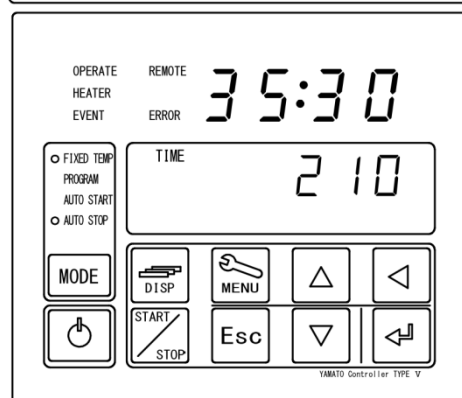
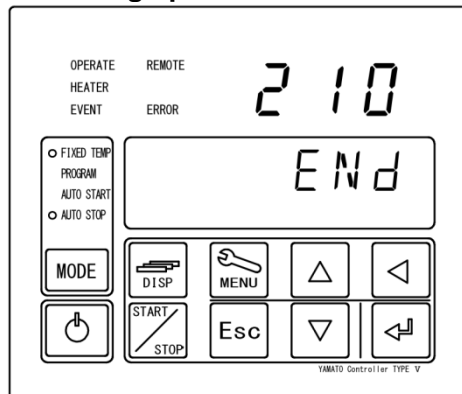

① When the set time duration elapses or the time comes, the Bottom screen will indicate [END] and operation will stop.

② Press the  key to eliminate the [END] indication.

※ When you stop operation, the screen will return to the one before starting operation.

※ The fan motor keeps operating after operation has been stopped. Press the  key longer to turn the controller power off to stop the fan motor.

# 4. Operating procedure

## Auto start operation

AUTO START (Automatic Start) mode is to start operation automatically with timer. This operation does not stop automatically once its start. Stop manually, if required.

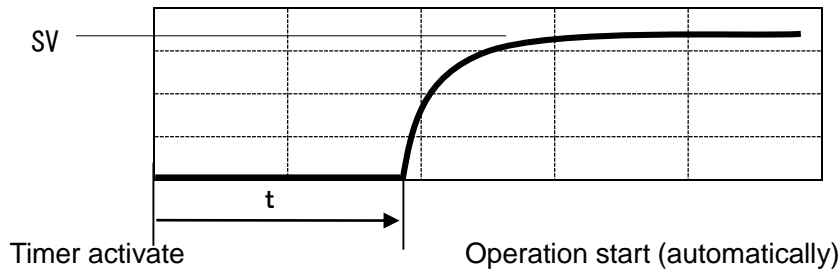

SV ; Target temperature    t ; Auto start setting time (time)

### Set Automatic Start mode

#### 1 Turn on the controller.

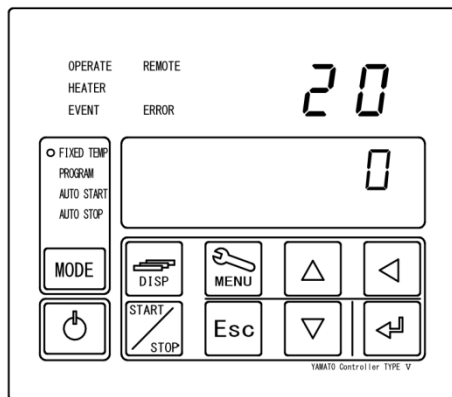

Turn on ( | ) Earth Leakage Breaker(ELB) on the right side wall of this Equipment. **(Idle State)**

Press and hold key to turn on the controller power. **(Standby State)**

Indicate circulating liquid temperature in Chamber on Top Screen and indicate target temperature on Bottom Screen.

The fan motor will start.

#### 2 Select Automatic Start mode

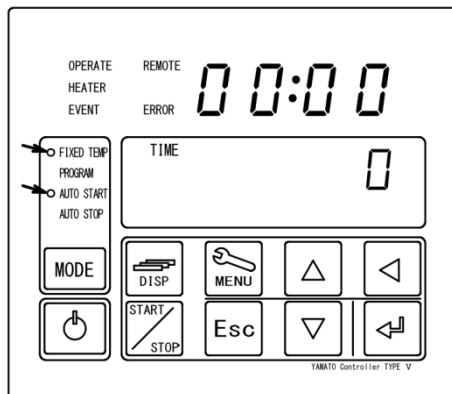

Press key to turn FIXED TEMP (Fixed Temperature mode) and AUTO START (Automatic Start mode) lamp on.

※ Fixed Temperature mode would be selected at first time operation. After that, the latest operated mode is selected.

#### 3 Set target temperature and operation wait time / clock time to start

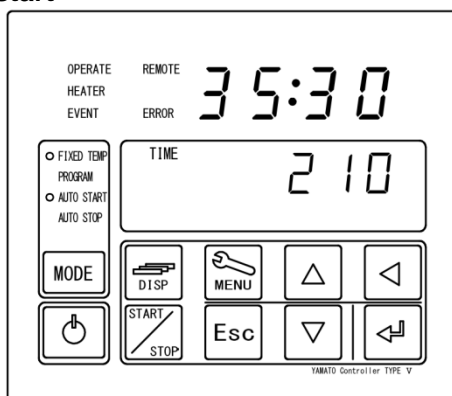

① Press key.

Select start method from TIME/CLOCK with keys and then press key.

② Set TIME (capable setting range: 0~99hr : 59min) or CLOCK (according to 24-hour time) on Top Screen and then press key.

③ Set target temperature on Bottom Screen and then press key.

# 4. Operating procedure

## Auto start operation

### Example 1. Setting wait time to start:

Press  key to count timer for 35 hours and 30 minutes, and then start automatically operation to reach to 250°C of target temperature in

35:30

TIME 2 10

### Example 2. Setting clock time to start:

Press  key to start automatically operation to reach to 250°C of target at temperature at 15:00.

15:00

CLOCK 2 10

## 4 Starting operation

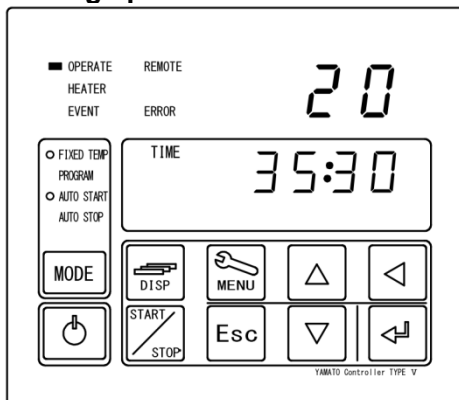

① Press  key to be standby mode for starting operation.

② Press  key to be standby mode for starting operation.

※ ※ The Top screen shows the present temperature in the chamber while the Bottom screens shows the operation wait duration and the operation start time. When you have selected a wait time, counting down of the set time starts.

20

TIME 25:37

※ You can check the set temperature on the Bottom screen using the  key.



20

2 10

Pressing the  key again will make the Bottom screen show the operation wait duration and the operation start time.

# 4. Operating procedure

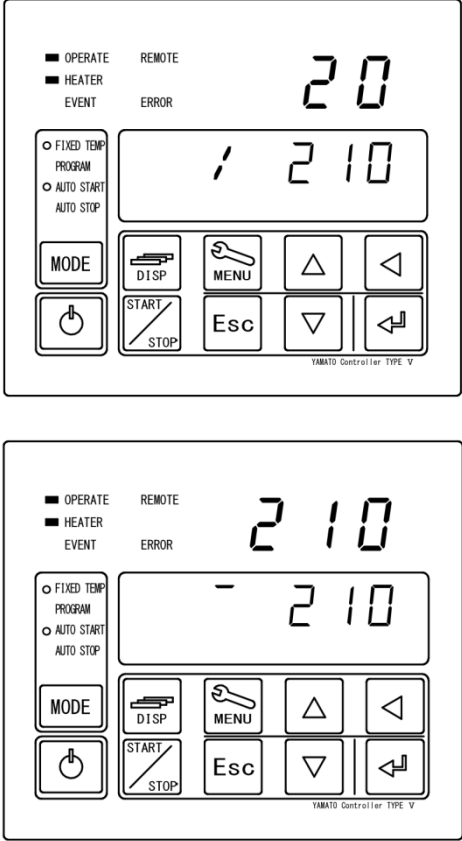
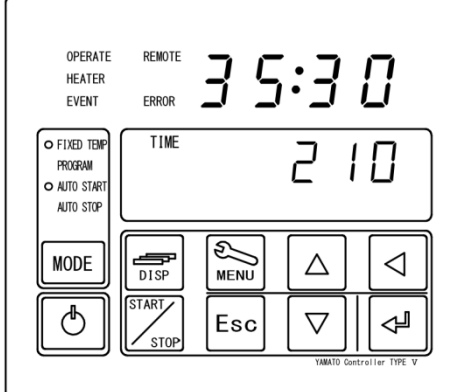
## Auto start operation

	<p>③ When the set time duration elapses or the time comes, the OPERATE (Operating) lamp will change its status from flashing to staying on as well as the HEATER (Heater) lamp comes on and temperature control will start.</p> <p>※ You cannot use the Quick auto stop function for the Auto start operation.</p>
<p><b>5 Stopping operation</b></p> 	<p>Use the  key to manually stop operation. The screen will return to the one before starting operation when you stop operation.</p> <p>※ The fan motor keeps operating even operation is stopped. Press the  key longer to turn the controller power off to stop the fan motor.</p>



# 4. Operating procedure

## Program operation

PROGRAM mode is to run programmed cycle such as figure below.

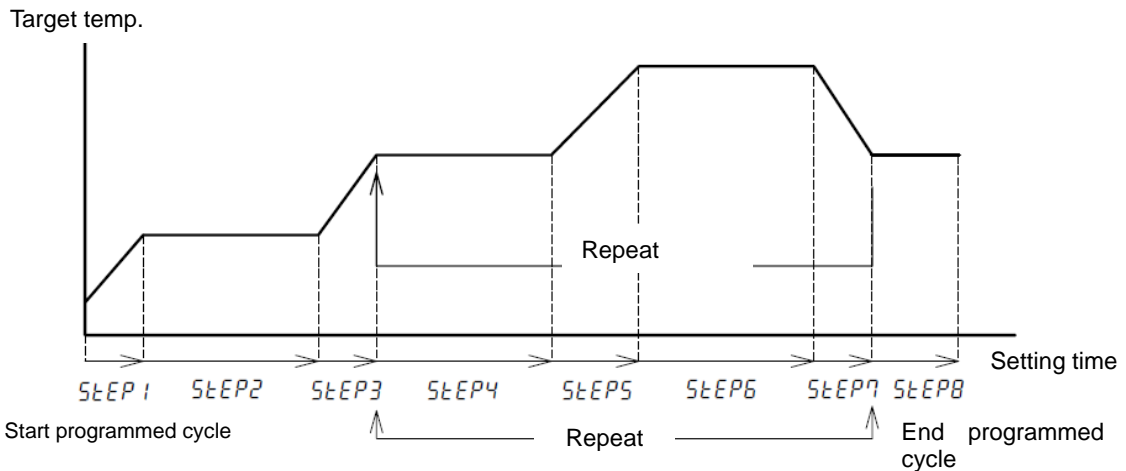

### Setting the program operation

#### 1 Turning on the controller

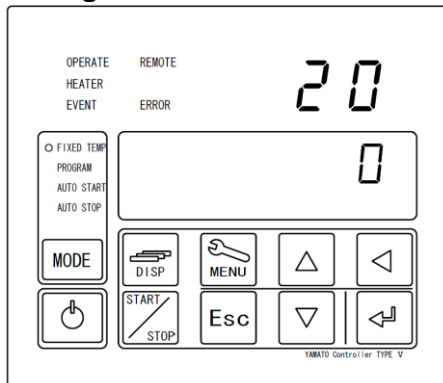

Turn the ELB on the left side of the main unit[ON ( | )]. Pressing the  key longer will turn the controller power on.

The Top screen shows the temperature in the chamber while the Bottom screen shows the set temperature. The fan motor will start.

#### \* Register target program prior to start running cycle at first.

For how to register a program, see "P.33 Programming method".

Create as many as steps up to 99 at maximum and save programmed pattern data up to 99 in total. (For example: 11 program patterns will be stored at maximum, if each pattern is programmed 9 steps. The number of steps in the repeat interval will be the number of the steps set in the registration part irrespective of the number of repetitions. )

#### 2 Select program mode

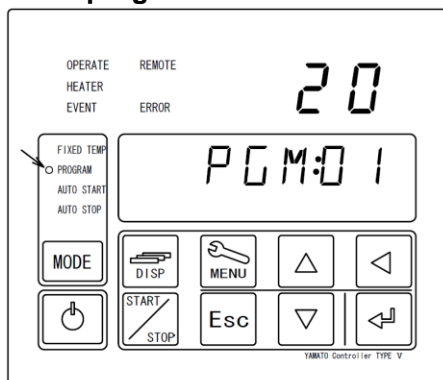









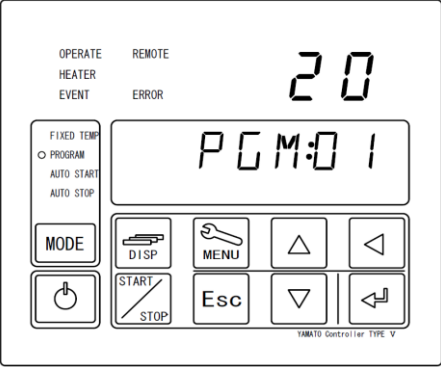

Press  key to turn PROGRAM Lamp on.

The bottom screen shows [PGM:01] ([01] indicates a program you used in the last session.)

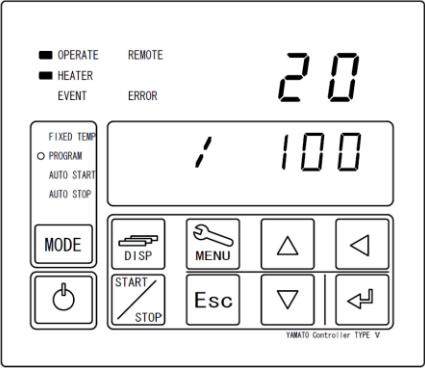
※ Fixed Temperature mode would be selected at first time operation. After that, the latest operated mode is selected.

# 4. Operating procedure

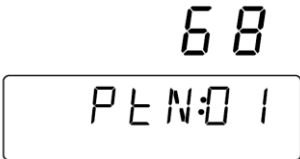
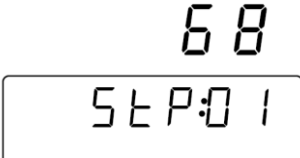
## Program operation

<p><b>3 Select program patter number</b></p> 	<p>Press  key. 01, a part of [PGM:01], is flashing on Bottom Screen. Select particular number of desired program pattern with   keys and then press  key.</p>
<p><b>4 Start program mode</b></p> 	<p>Press  key to start programmed cycle operation.</p> <ul style="list-style-type: none"> <li>※ Never run its cycle if [END] is not set at the end step in the program. Check again that program setting, if cycle do not start.</li> <li>※ You cannot start operation by pressing the  key for pattern numbers for which any programs are not registered.</li> <li>※ You can check the program pattern number, the step number or the remaining operation time being executed on the Bottom screen with the  key during operation.</li> <li>※ Screen to check the number of a program pattern being executed.             <div style="text-align: center; margin: 10px 0;">  </div> </li> <li>※ Screen to check the number of a program step being executed.             <div style="text-align: center; margin: 10px 0;">  </div> </li> <li>※ Screen to check the remaining time of a step being executed.             <div style="text-align: center; margin: 10px 0;">  </div> </li> </ul>

## 4. Operating procedure

### Program operation

#### 5 Cancelling program operation

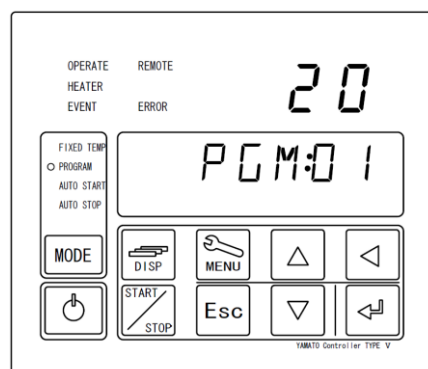
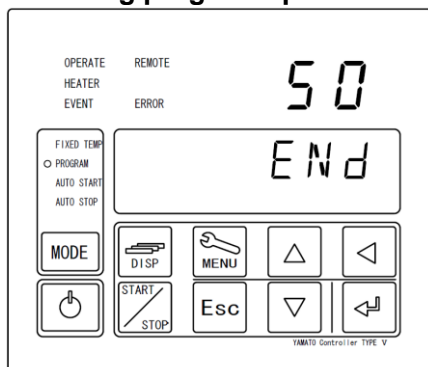

① When the set program ends, the Bottom screen shows [END] and operation will stop.

② You can eliminate the [END] indication using the  key.

※ The screen will return to the one before starting operation when you stop operation.

※ The fan motor keeps operating after operation is stopped. Press the  key longer to turn the controller power off to stop the fan motor.

# 4. Operating procedure

## Programming Method

### Sample program setting

In this example, 8 steps are registered in the program pattern 2, steps from 4 to 7 will be repeated 5 times and the whole session will end at the step 8.

Note: Steps 4 to 7 will be repeated 6 times.

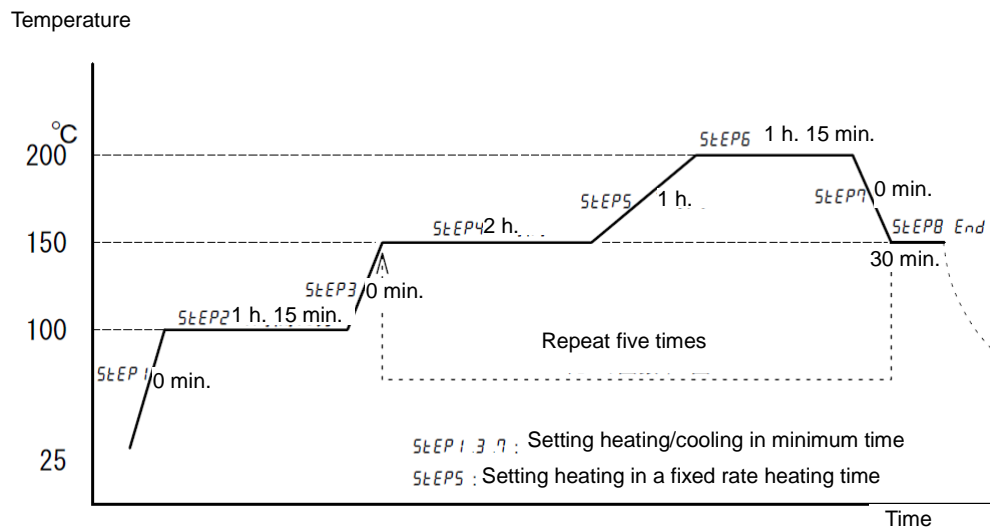







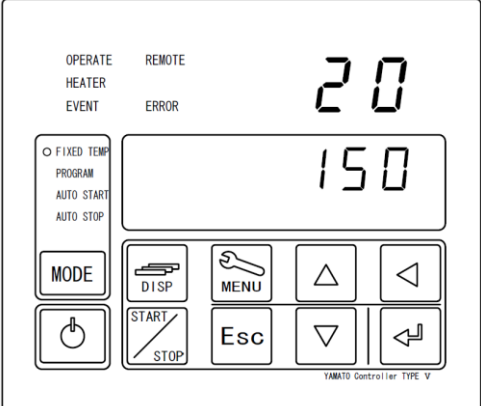

Pattern No	Step	Set temp.	Set time	Repeat dstn.	Repeat No.	Wait	End
P** :01	P02: **	TEMP	TIME	REP(STEP)	REP(COUNT)	WAIT	ENDST
02	01	100	00:00	0	0	ON	OFF
	02	100	01:15	0	0	OFF	OFF
	03	150	00:00	0	0	ON	OFF
	04	150	02:00	0	0	OFF	OFF
	05	200	01:00	0	0	ON	OFF
	06	200	01:30	0	0	OFF	OFF
	07	150	00:00	4	5	ON	OFF
	08	150	00:30	0	0	OFF	ON

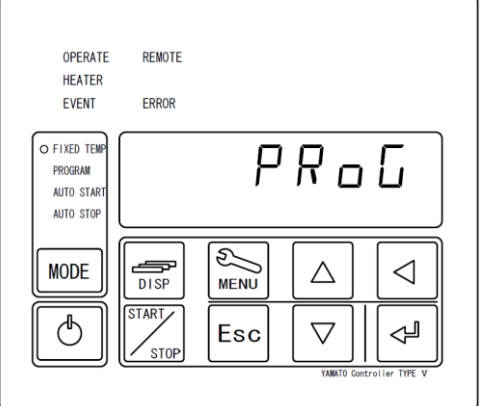
- ※ When set time for heating or cooling steps beyond the heating or the cooling capacity (0 minute in the example) of the unit, it will operate at the full power for a short time at wait **[ON]**. At wait **[OFF]**, the step will proceed to the next one irrespective of whether the set temperature is attained or not and you need to take care for setting a wait for heating or cooling for a short period.
- ※ When set time for heating or cooling steps beyond the heating or the cooling capacity of the unit, it will heat or cool at a fixed rate irrespective of the wait setting of **[ON]** or **[OFF]**, and the operation will proceed to the next step once the set temperature is reached within the set time.
- ※ When a fixed temperature step is set and wait is **[ON]**, the wait mode will continue from the time when the temperature in the chamber drops below the lower limit of the wait width deviation temperature due to, for example, opening of the door until the temperature in the chamber will recover above that lower limit. At **[OFF]** the process will proceed to the next step after the set time irrespective of changes of the temperature in the chamber.
- ※ When you use the repeat function, program the operation so that the set temperature before shifting to the repeat mode will be the same as the set temperature of the destination of repetition.
- ※ Checking the heating capacity and the cooling capacity before setting is encouraged since these will differ depending on the environmental temperature and the operating conditions.

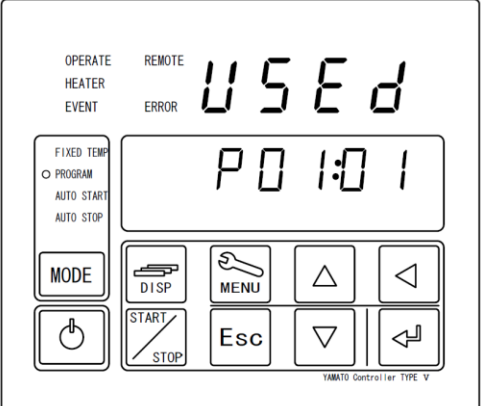



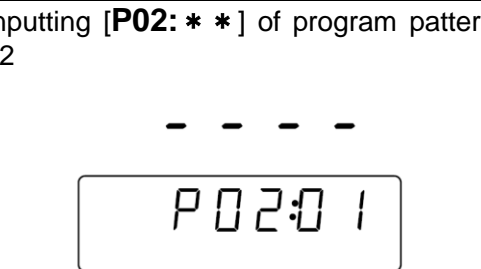









































# 4. Operating procedure

## Programming Method

NO	Indication	Operating procedure
I		
II		<p>[PROG] flashes.</p> 
III		<p>○ The PROGRAM lamps flashes.</p>  [USED] means that the program has already been registered.  [1] of P01:01 flashes.  Makes [1] of P01:01 flash.  Input as [P02:01].
1-1	<p>Inputting [P02: * *] of program pattern 02</p> 	<p>[2] of P02:01 flashes and the Top screen shows [----] which means any programs are not registered.</p>







# 4. Operating procedure

## Programming Method

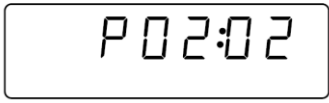
1-2		<p>Input pattern 02, STEP 01.</p>  TEMP flashes.
1-3		<p>Input 100°C.</p>  [000] flashes      
1-4		<p>00 hour 00 minute</p>  TIME flashes    
1-5		<p>Repeat:0 (No repeat destination)</p>  REP flashes.    
1-6		<p>Number of repetition:0 (No repetitions)</p>  REP flashes.    
1-7		<p>Wait function ON setting (Set time counts down when the indicated temperature is -3°C to the set temperature and within +6°C.)</p>  WAT flashes.       
1-8		<p>END setting OFF (To input the next step, set this to OFF; to input the final step, set this to ON)</p>  All program setting items flash       
1-9	<p>If a setup of STEP1 is completed</p>	<p>Press the  key longer.</p>

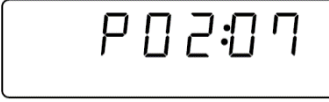

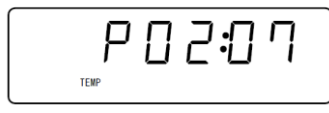

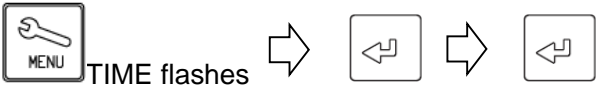
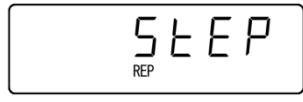
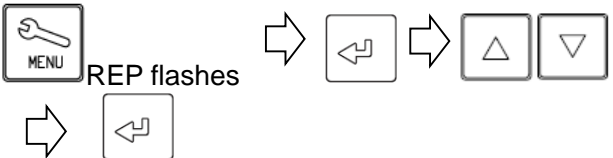



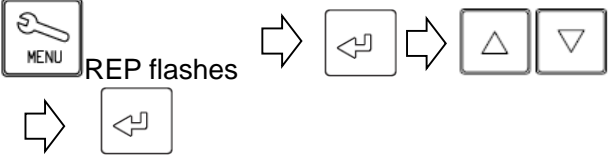

# 4. Operating procedure

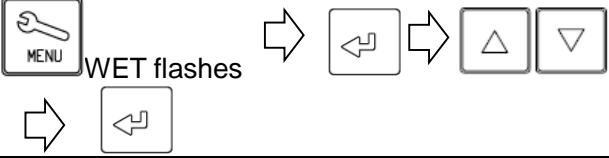
## Programming Method

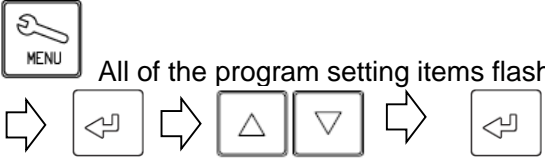
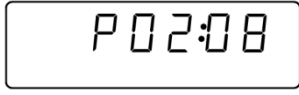
2-1		Input pattern 02, STEP 02 
STEP02 } STEP03 } STEP04 } STEP05 } STEP06	Input parameters from <b>STEP #2</b> to #6 in accordance with setting conditions with same process of inputting parameters on <b>STEP #1</b> .	※ Press  key while registering program. Show [REST. P] on Bottom Screen. And show the rest of available steps on Top Screen.
7-1		Input pattern 02, STEP 07  TEMP flashes.
7-2		Input 150°C. 
7-3		Input 00 hour 00 minute. 
7-4		Input repeat destination (Repeat dstn : 4) 

# 4. Operating procedure

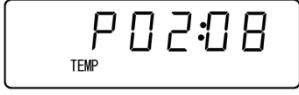

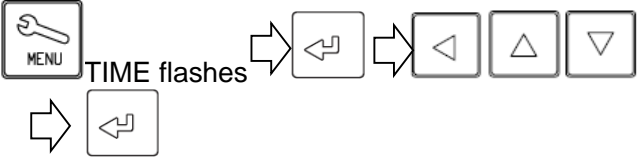





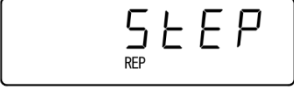

## Programming Method

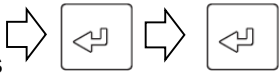
<p>7-5</p> 		<p>Input the number of repetitions (Number of repetitions : 5)          ※ Number of repetitions may be set between 1 and 99 or [INF], limitless.</p>  <p>REP flashes</p>
<p>7-6</p> 		<p>Set the wait function to ON.          ( Set time counts down when the indicated temperature is -3°C to the set temperature and within +6°C.)</p>  <p>WET flashes</p>
<p>7-7</p> 		<p>END setting OFF (To input the next step, set this to OFF; to input the final step, set this to ON)</p>  <p>All of the program setting items flash</p>
<p>8-1</p> 		<p>Input pattern 02. STEP 08</p>  <p>Press the  key longer.</p>  <p>TEMP flashes.</p>
<p>8-2</p> 		<p>Input 150°C.</p> 
<p>8-3</p> 		<p>Input 00 hour 30 minutes.          ※ Inputting [INF] for the final step makes its time limitless.</p>  <p>TIME flashes</p>



# 4. Operating procedure

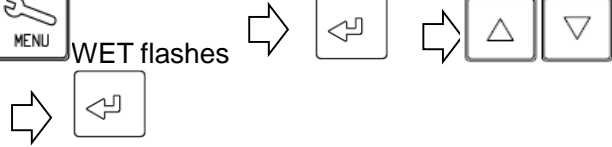
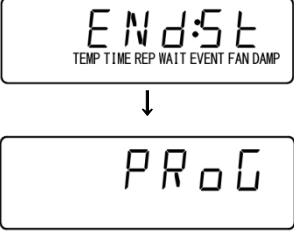







## Programming Method

<p>8-4</p>		<p>Input repeat [0] (No repeat dstn)</p>  <p>REP flashes</p> 
<p>8-5</p>		<p>Input a repeat number of [0] (No repetitions)</p>  <p>REP flashes</p> 
<p>8-6</p>		<p>Set the wait function to <b>OFF</b>.</p>  <p>WET flashes</p> 
<p>8-7</p>		<p>Set <b>END</b> to [ON].</p>  <p>All of the program setting items flash</p>  <p>※ Be sure to set the <b>END</b> step <b>ON</b> for the final step of a program pattern. Any operation programs without an <b>END</b> step <b>ON</b> will not be recognized as a complete program.</p>

※ Duplicate and use the programming sheet at the end of this book.







# 4. Operating procedure

## How to copy or delete programs

<p>1-1</p>		<p>※ Copying a program</p> <p>Use the  key to flash [CoPYP] on the Bottom screen and press the  key.</p>
<p>1-2</p>		<p>When [01] of PGM:01 flashes, input the pattern number to copy from with the   keys and then determine using the  key.</p>
<p>1-3</p>		<p>[DEST] flashes on the Top screen shows while pattern numbers not used and [**] of PGM:** flash on the Bottom screen and input a pattern number [**] of the copy destination with the   keys and determine using the  key.</p>
<p>1-4</p>		<p>The Top screen shows [01] and the Bottom screen shows the pattern number of the copy source- copy destination number [01-02] then the screen will move to the program copy screen.</p>

# 4. Operating procedure

## How to copy or delete programs

<p>2-1</p>		<p>※ Deleting a program You cannot delete a program during operation. Carry out deletion while the stand-by screen is displayed.</p> <p>Use the  key to flash [DEL P] on the Bottom screen and then press the  key.</p>
<p>2-2</p>		<p>When [01] of PGM:01 flashes, select a pattern number to delete with the   keys or select [AL](all delete) with the  key and then press the  key longer.</p>
<p>2-3</p>		<p>When [DEL] flashes, determine using the  key.</p>
<p>2-4</p>		<p>The Top screen shows [o h] and the Bottom screen shows the pattern number of the copy source- copy destination number [PGM:02] then the screen will move to the program delete screen.</p>

# 4. Operating procedure

## About the wait function

When the wait function is set to [ON], the mode will remain “waiting” without counting down the time until temperature in the chamber (indication) will be within the wait deviation range between  $-3^{\circ}\text{C}$  and  $+6^{\circ}\text{C}$  to the set temperature. When you set the set time to 0 minute, the unit will operate from the “Start temperature” to the “Set temperature” at full power.

When you have set time longer than the specified performance, the unit will control heating and cooling so that the set temperature will be attained (within the wait width deviation range) at the set time.

Even when the indicated temperature drops while temperature is stable due to opening of the door, the mode will remain “waiting” without counting down the time if the wait width upper or lower limit is exceeded.

When you set the wait function to [OFF], the unit will proceed to the next step at the set time irrespective whether the temperature is within the wait width deviation between the set temperature and the indicated temperature.

When the set time is set to a short time exceeding the heating and cooling capacity, the unit will proceed to the next step before the set temperature is attained and you need to make sure that the wait function is set at [ON] when you are going to operate at the full power.

※ Example of estimated heating/cooling at indicated setting of wait [All ON] and [ALL OFF] in the program in the table below.

Step	1	2	3	4	5	6	7	8	9	10
Set temp( $^{\circ}\text{C}$ )	100	100	50	50	100	100	50	50	75	75
Set time	0 min	30 on	0 min	30 min	0 min	5 min	0min	5 min	2 hr	30 min
	Heating and cooling time of steps (1), (3), (5) and (7) are at the full power setting.									
	Heating time of the step (9) has been set longer than the specification.									

### 【Example of estimated process at “Full ON” setting for the wait function】

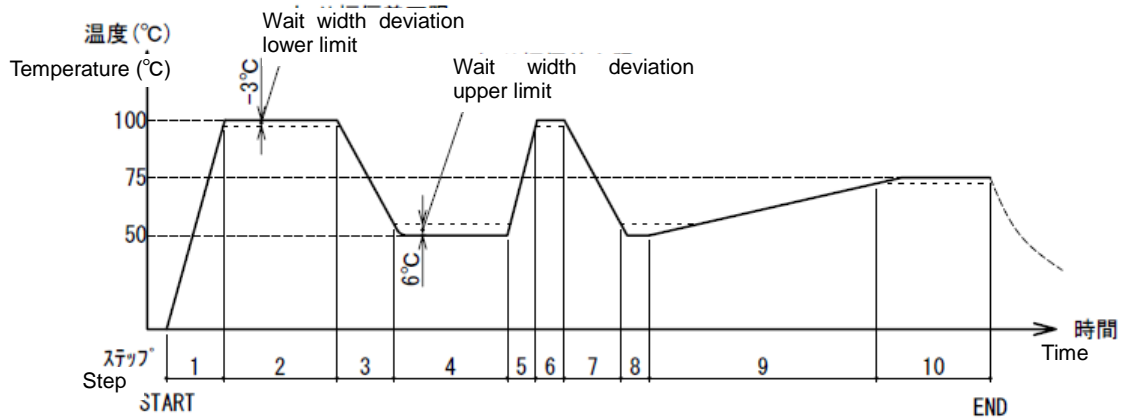

### 【Example of estimated process at “Full OFF” setting for the wait function】

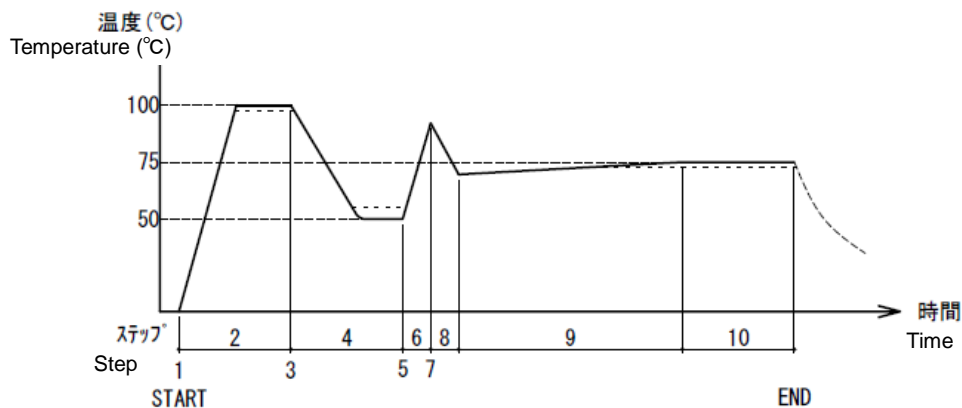

# 4. Operating procedure

## Setting key lock mode

※ Set a type of key lock.

### 1 Turn the controller power off

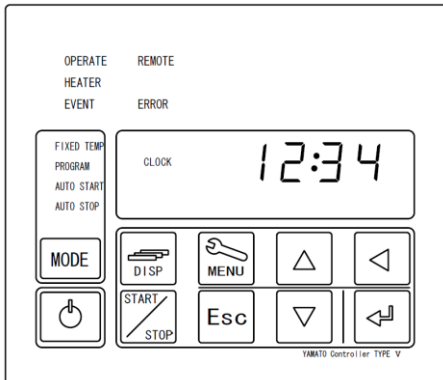

Turn the ELB on the left side of the main unit [ON( | )]. The Bottom screen will show the current time.



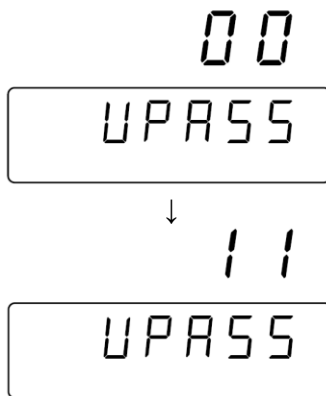

While the unit is being operated, press the  key longer to turn the controller power off.

### 2 Enter password



① Press and hold  key.



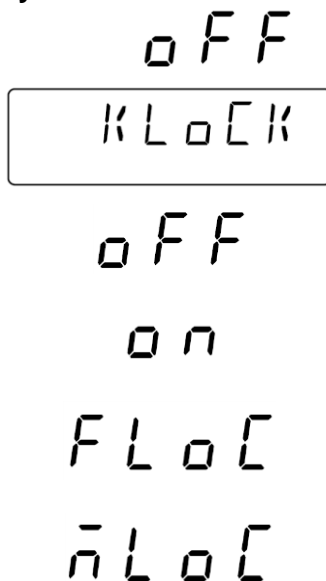

Show [UPASS] on Bottom Screen and [00] flashing on Top Screen.

② Press   and  keys to enter password "11" on Top Screen and press  key (The password is fixed to "11").



### 3 Set key lock



① The Bottom screen shows [KLOCK] while the Top screen shows [OFF]. [OFF] is the factory setting.

② Use the     keys to select a type of key lock and then determine using the  key.

OFF : Key lock function disabled (Factory setting)

ON : Any keys other than the  and the  keys are disabled.

FLOC : Only the  key is disabled.

mLOC : Only the  key is disabled.

③ Pressing the  key longer will return to the time display screen.

# 4. Operating procedure

## Calibration offset

**Calibration Offset Function** offset the difference between read temperature by this Controller and actual measured temperature of Chamber. This Function enable parallel compensation in minus or plus direction over the whole Controller Temperature Setting Range of this Equipment.











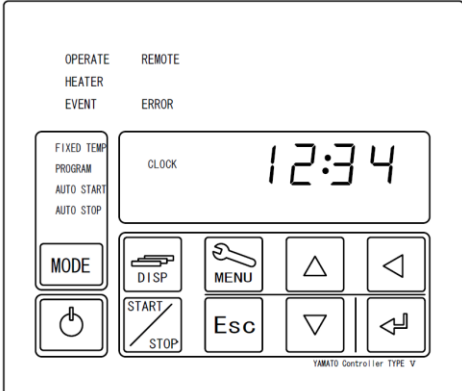



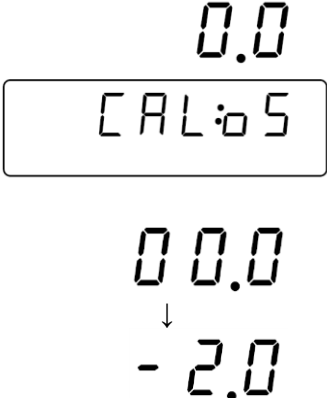

### Example

When the measured Chamber temperature is lower than read temperature by 2°C:

The read temperature can be calibrated by inputting "Calibration Offset value -2.0" for 2°C compensation against actual Chamber temperature.

If read temperature is 200°C for example, its temperature will shift to 198°C after offset calibration.











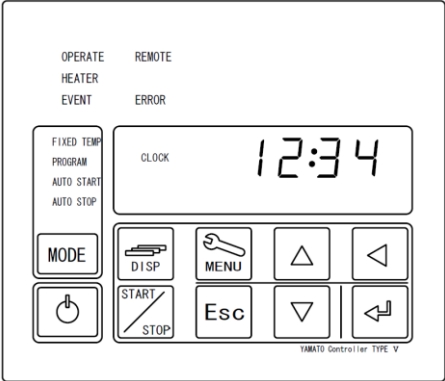



※ This -2°C compensation is applied over the whole controller Temperature Setting Range (0 ~210°C). Note that offset value might be changed depending on sample setting arrangement and/or Target Temperature.

<p><b>1 Turning the controller power off</b></p> 	<p>Turn the ELB on the right side of the main unit [ON(   )]. The Bottom screen will show the current time.</p> <p>While the unit is being operated, press the  key longer to turn the controller power off.</p>
<p><b>2 Enter password.</b></p> 	<p>① Press and hold  key. Show [UPASS] on Bottom Screen and [00] flashing on Top Screen.</p> <p>② Press   and  keys to enter password "11" on Top Screen and press  key (The password is fixed to "11").</p>
<p><b>3 Set Calibration Offset value.</b></p> 	<p>① Press  key to display [CAL:0S] on Bottom Screen then press  key.</p> <p>② Input offset value by   and  keys and then press  key. You can enter an offset amount up to ±15.0°C</p> <p><b>Example</b> Read temperature : 200°C and actual measured temperature : 198°C ⇒Offset input value: -2.0°C</p> <p>※ Although you can input values up to the first decimal place, the temperature indications and measured temperatures will be rounded before indication.</p> <p>③ Pressing the  key longer will return to the time display screen.</p>

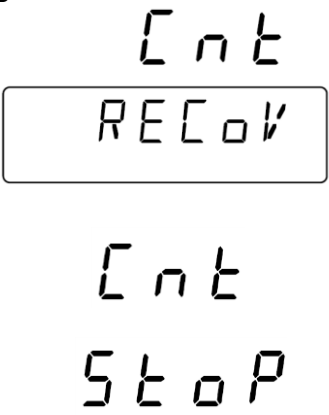
# 4. Operating procedure

## Setting the recovery mode

※ Describe the recovering operation at power failure.

<p>1</p>	<p><b>Turning the controller power off</b></p> 	<p>Turn the ELB on the right side of the main unit [ON(   )]. The Bottom screen will show the current time. While the unit is being operated, press the  key longer to turn the controller power off.</p>
<p>2</p>	<p><b>Enter password.</b></p> 	<p>③ Press and hold  key. Show [UPASS] on Bottom Screen and [00] flashing on Top Screen.</p> <p>④ Press   and  keys to enter password "11" on Top Screen and press  key (The password is fixed to "11").</p>
<p>3</p>	<p><b>Setting recovery from a power outage</b></p> 	<p>① Press  key to display [RECOV] on Bottom Screen and then press  key.</p> <p>② Press   key to select recovery type at power failure and press  key.</p> <p>CNT : The operation will resume right at power failure after power recovery. (set at factory)</p> <p>STOP : The operation will terminate as Idle State after power recovery.</p> <p>③ Pressing the  key longer will return to the time display screen.</p>

# 4. Operating procedure

## Resetting integrated CO2 volume and CO2 emission factor

※ Explain how to set conversion factor for CO2 emission and how to reset the integrated CO2 volume on Top Screen.

### 1 Turning the controller power off

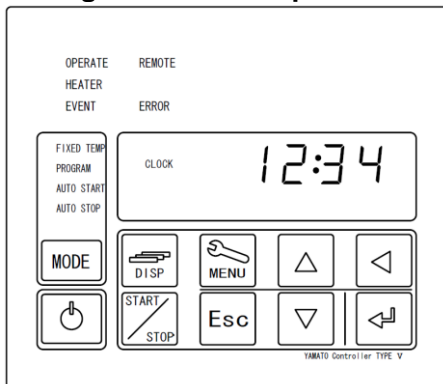

Turn the ELB on the left side of the main unit [ON( | )]. The Bottom screen will show the current time.

While the unit is being operated, press the key longer to turn the controller power off.

### 2 Enter password.



① Press and hold key.  
Show [UPASS] on Bottom Screen and [00] flashing on Top Screen.

② Press and keys to enter password "11" on Top Screen and press key (The password is fixed to "11").

### 3 Reset monitor display.

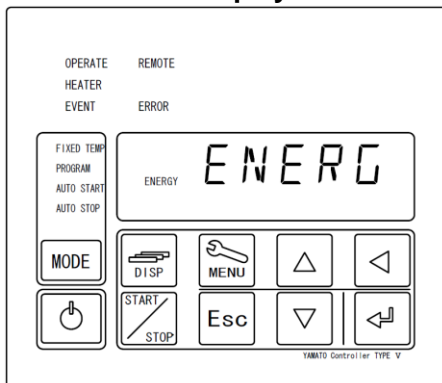

① Pressing the key will make the monitor function indication ENERGY and [ENERG] flash on the Bottom screen.

② Pressing the key will show items to reset integrated [POWRT] power consumption.

③ Press key to select monitoring item on Bottom Screen and then press key.

POWRT : Integrated power consumption

Pressing the key will result in:  
OFF (lit) → RUN (flash)

Press key to reset Integrated Power Consumption.

Press key to return to [PoW:Rt].



## 4. Operating procedure

### Resetting integrated CO2 volume and CO2 emission factor

3

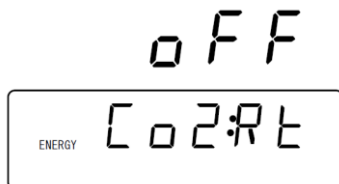
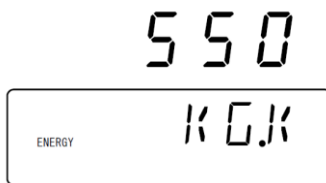

KG. K : (CO<sub>2</sub>) discharge coefficient

Quoted from the substitutive values, factory setting of **550** ( 0.000550t-CO<sub>2</sub>/kWh ) , the Environmental Ministry Press Release on 6 November 20013.

Confirm the discharge coefficient of different utility companies with each company.

Pressing the  key will result in:  
**550** (lit) → **0550** (flash)

Press the    keys to change a discharge coefficient.

 key is used to determine

 key is used to return

CO<sub>2</sub>:RT : Integrated CO<sub>2</sub> Emission

Press  key, and then change from OFF (illuminate) to →RUN (flash) on Top Screen.

 key is used to reset Integrated CO<sub>2</sub> Emission.











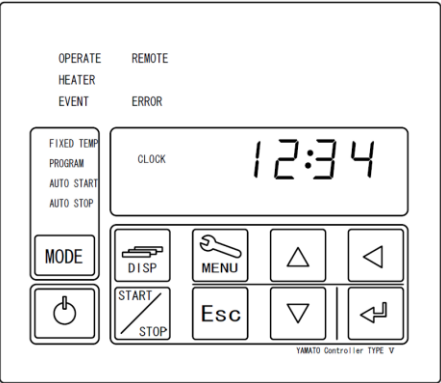

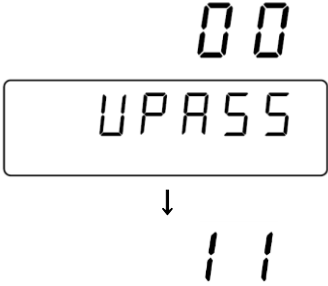



 key is used to return

④ Pressing the  key longer will return to the time display screen.

# 4. Operating procedure

## Backup data saving / reading out / resetting

※ Back up, read out and reset controller for various setting information.

<p><b>1 Turning the controller power off</b></p> 	<p>Turn the ELB on the left side of the main unit [ON(   )]. The Bottom screen will show the current time.</p> <p>While the unit is being operated, press the  key longer to turn the controller power off.</p>
<p><b>2 Enter password.</b></p> 	<p>③ Press and hold  key.</p> <p>Show [UPASS] on Bottom Screen and [00] flashing on Top Screen.</p> <p>④ Press   and  keys to enter password "11" on Top Screen and press  key (The password is fixed to "11").</p>
<p><b>3 Save and read out and/or reset setting information.</b></p> 	<p>① Press  key few times and show following items on Bottom Screen, respectively:</p> <p>U BKS : Back various setting information up.   key「RUN」(flash)→ key「OFF」(illuminate)</p> <p>U BKR : Read backup setting information out.   key「RUN」(flash)→ key「OFF」(illuminate)</p> <p>INI. U : Initialize various setting information.   key「RUN」(flash)→ key「OFF」(illuminate)</p> <p>※ Various setting information will be included registered programs, temperature offset value and other data such as key lock mode, calibration offset, recovery mode and so forth.</p> <p>② Pressing the  key longer will return to the time display screen.</p>

# 4. Operating procedure

## Monitoring data

※Check Integrated Power Consumption, integrated Operating hours and so forth by this “Monitor Item Display” function of this Equipment.

Can not modify any setting information shown on Top Screen.

### 1 View integrated value on Top Screen

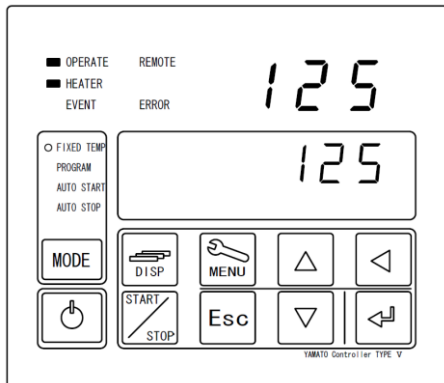

0.0



123

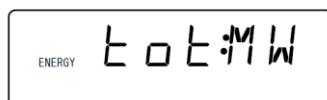

456

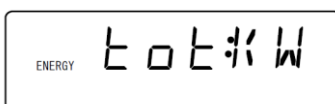

456

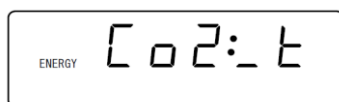

789

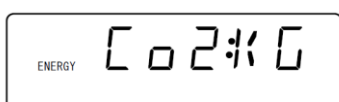

※Monitor Items can be checked at Controller POWER key ON or during operation state.

Press and Hold  key.

Monitor Items display screen activate and current Power Consumption appear on Top Screen.

Use the  key shows the integrated power consumption (MW) (kW), CO2 discharge amount (t) (kg) heater operation amount (%), integrated live time (Unit: 10000 hours) (Unit: 1000 hours), integrated operation time (Unit: 10000 hours) (Unit: 1000 hours).

Monitor Items display screen is ended, and Idle Screen or Standby Screen is displayed finally.

**KW** Current Power Consumption is calculated from instantaneous power to power at one hour. Power consumption may be indicated as [0.0] and [3.6] alternately while temperature is stable. Power consumption is indicated as [0.0] during standby.

**TOT:MW** Integrated power consumption (MWh). This is indicated in a three-digit integer number.

**TOT:KW** Integrated power consumption (kWh). This is indicated in a three-digit integer number.  
 【 Sample indication 】 Integrated power consumption:123,456kWh

**CO2:\_T** CO2 discharge amount (t). This is indicated in a three-digit integer number.

CO2 discharge amount is calculated by multiplying the power consumption by a discharge coefficient. Confirm the discharge coefficient of different utility companies with each company.

The initial value input is quoted from the substitutive values, factory setting of 0.550(k-CO2/kWh), the Environmental Ministry Press Release on 6 November 2013. For updates of the coefficients, see the section, Setting and resetting the monitor indication, item [3].

**CO2:KG** CO2 discharge amount (kg). This is indicated in a three-digit integer number.

【Sample indication】 CO2 discharge amount:456,789kg

<p style="text-align: center;">45.6</p> <div style="border: 1px solid black; padding: 5px; margin: 5px 0;">ENERGY PID:MV</div> <p style="text-align: center;">5</p> <div style="border: 1px solid black; padding: 5px; margin: 5px 0;">ENERGY POW:TM</div> <p style="text-align: center;">67</p> <div style="border: 1px solid black; padding: 5px; margin: 5px 0;">ENERGY POW:TM</div> <p style="text-align: center;">1</p> <div style="border: 1px solid black; padding: 5px; margin: 5px 0;">ENERGY RUN:TM</div> <p style="text-align: center;">23</p> <div style="border: 1px solid black; padding: 5px; margin: 5px 0;">ENERGY RUN:TM</div>	<p><b>PID:MV</b> Heater Operation Output Heater Operation Output is the parameter to control output power ratio in percent of heater rated capacity. Heater output will be controlled by PID operation value between 100 to 0% till reaching to Target Temperature.</p> <p><b>【Sample indication】</b> Present heater operation amount: 45.6%</p> <p><b>POW:TM</b> Integrated live time (hours). Only the ten thousand digit will be indicated.</p> <p>Integrated live time shall be the accumulated time elapsed from turning the ELB ON ( ) to OFF OFF(○).</p> <p><b>POW:TM</b> Integrated live time (hours). Up to the thousand place is displayed.</p> <p><b>【Sample indication】</b> Integrated Power ON Hours ; 50,067 hours Adding capability will up to 65,535 hours.</p> <p><b>PUN:TM</b> Integrated operation time (hours). Only the ten thousand digit will be indicated.</p> <p>Integrated Operation Run Hours mean to add operation hours from start to end.</p> <p><b>PUN:TM</b> Integrated operation time (hours). Up to the thousand place is displayed.</p> <p><b>【Sample indication】</b> Integrated live time: 10,023 hours Up to 65535 hours can be cumulated.</p> <p>Use the  key to the standby/operating screen.</p>
--	---

## 4. Operating procedure

### Independent Overheat Prevention Device

This Equipment have redundant safety devices-1) Automatic Overheat Prevention (automatic reset) function on the Controller, and -2) Independent Overheat Prevention Device(IOPD) with independent power, circuit and sensor away from the Controller.

Main Relay of this Controller will be shut heater output power off when one of safety devices is activated at Chamber internal temperature beyond its setting temperature.

Those functions will avail at Earth Leakage Breaker(ELB) ON ( | ).

#### Set temperature on Independent Overheat Prevention Device(IOPD)

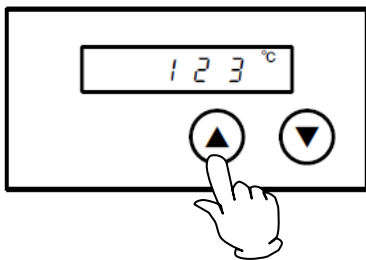

※Set temperature with ▼▲ keys on its panel.



May stop its operation by activating Independent Overheat Prevention Device(IOPD) when the difference between set temperature on IOPD and Target Temperature will be too close each other. Must set IOPD temperature at least 20°C higher than Target Temperature.

Note that the objective of this IOPD will not protect for samples but from overheating this Equipment.

Factory settings and setting temperature ranges are as shown below:

Model	Set temperature at shipment	Setting temperature range
All models	240°C	0°C~260°C

Control Chamber stable at required temperature first, and let IOPD setting temperature down by 1°C and then find out IOPD activating temperature, if IOPD will get to be activated at required temperature.

Must wait for 5(five) seconds for the next 1°C down of IOPD setting temperature, because its function will be operated to need some times.

Display ERO7 on Top Screen on Control Panel, if this IOPD is activated.

When you have set an operation temperature you want for IOPD, recording of the set temperature takes several seconds and you need to wait for about five seconds before turning the ELB off.

## 5. Handling precautions



### Warning

#### 1. Never use any explosive or flammable substances.

-  Never process any explosive, flammable samples and also samples contained with those substances. It will cause fire/explosion. (See Chapter 13. List of dangerous materials on page 71.)



#### 2. Take extreme care when using a resin container.

-  Be sure to check the withstand temperature before using a resin container. Using such a container under a temperature beyond its withstand temperature will melt resin and a fire or an explosion may result.

#### 3. Turn the ELB off when an abnormality occurs.

-  If unit begins emitting smoke or abnormal odors for reasons unknown, turn off main ELB immediately, disconnect power cable from power supply, and contact original dealer of purchase. Continuing to operate without addressing abnormalities may disassemble or repair unit. Repairs should be always be performed by a certified technician.



#### 4. Do not put any foreign objects in the unit.

-  Never insert any metal or easily flammable objects into the openings in the chamber (radiation port, cable port, etc.). A fire, an electric shock or burning may result.
-  If a foreign object has entered inside, immediately turn the ELB off and ask your dealer, one of our sales offices or the customer service center for inspection. Leaving as it is will cause a fire or an electric shock.

#### 5. Take extreme care for handling of samples after operation at a higher temperature.

-  Take care not to touch samples when taking them in or out since inside the chamber, internal wall of the door or samples are still hot for some time after operation at a higher temperature. Be sure to put on heat-resistance gloves and take extreme care for burning when handling samples.

#### 6. Take extreme care when opening the door during operation at a higher temperature.

-  When you attempt to open the door during operation at a higher temperature, never touch the door since the internal chamber or the inside of the door are hot. When the door is opened, the heater and the fan motor will stop for safety but note that the fan motor will keep rotating from inertial and hot air will be blown out.
-  Note that if a fire alarm is installed around the unit, it may go off erroneously.

#### 7. Never attempt to touch hot surfaces.

-  Never touch the door, the cable port, suction port or around the exhaust port during or immediately after operation. They are hot and may cause burning.

## 5. Handling precautions



Caution

### 1. Do not climb on the Equipment.



Do not climb on this Equipment. May cause personal injury and/or its failure by tipping it over and being damaged.

### 2. Do not place any stuff on the Equipment



Do not place any stuff on this Equipment. May cause personal injury falling it off.  
Do not close up any flammable materials such as paper around it.

### 3. Turn immediately off the Breaker of the Equipment at thundering.



Turn immediately off the Breaker of the controller, when thundering and lightning start. If do not so, it may cause fire or electric shock by the thunderbolt.

### 4. Do not keep Door open after operation.



Do not keep Door open to cool the sample down quickly, etc. right after operation. May deform Control Panel and cause failure of this Controller by heat wave from Chamber.

### 5. Do not process any corrosive samples.



Do not process any samples containing corrosive chemicals even though Chamber is made of stainless steel which this steel may be corroded by strong chemical acid, etc.

### 6. Operate at the proper temperature.



Operating temperature range will be room temperature+20°C~210°C(DNE401/411/601/611) and +15°C~210°C(DNE811/911).  
Never operate this Equipment at temperature out of its range. Operating the unit outside the operating temperature range may cause a malfunction of the unit or an accident.

### 7. Take extreme care when placing samples.



Do not set samples heavier than 15kg. Weight capacity of one shelf will be about 30kg  
Spread samples evenly throughout on each shelf as many as possible.

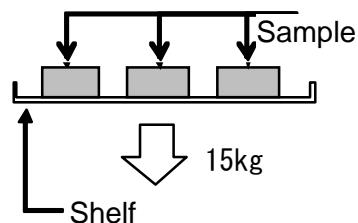

Do not set excessive amount of samples on shelves. Chamber temperature may not be controlled correctly. Must keep following procedure to control Chamber temperature correctly; 1) install the supplied shelves, 2) keep space between samples as wide as possible. 3) require space opening more than 30% at each shelf.

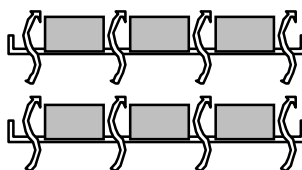

Require space opening more than 30% at each shelf.

## 5. Handling precautions



Caution

### 8. Never set samples on bottom of Chamber.



Never set samples on bottom of Chamber. If samples will be processed at setting on bottom of it, this Equipment may be not given as its full performance and become high temperature unlikely and also cause failure.

Set samples on attached shelves properly installed on their brackets.

Do not allow samples to contact directly to side walls of Chamber.

### 9. Do not process humid or wet specimens.



Do not process humid specimens.

Water condensed inside the unit may cause an electric shock, a malfunction of the unit.



Before processing a wet specimen, completely drain water off. Otherwise, rust, corrosion or condensation may occur in and out the bath and excessive increase in humidity may adversely influence to the electric system causing an electric leak or other malfunctions or preventing proper operation.

### 10. Take care for processing of powder and small samples.



The unit employs blowing to improve temperature distribution inside the chamber. When processing powder or small samples, make sure that the sample will not scatter. A fire or an electric shock may result if a flammable or a metal object enters the heater.



Heating may take some time when the amount of samples is large or when processing samples with a larger heat burden. Check the appropriate amount as necessary and set the sample. Also note that the temperature indication may be unstable when processing heat-generating samples (note that sample itself must be free of fear of explosion, inflammation or ignition).

### 11. Note that the sample temperature and the measured temperature are not always the same.



Be aware of temperature sensor which it is installed on Chamber inside upper portion and control Chamber temperature. Therefore, if the amount of specimen is large or the equipment is in the middle of heating, sensor detected temperature may not agree with temperature of the samples. In particular, actual Chamber temperature will differ greatly from Read Temperature displayed on Controller, right after opening or closing of this Equipment Door.

When a gap occurs between the temperature in the bath and the measured temperature requiring adjustment, compensate temperature by referring to “P.43 Setting a calibration offset” .

### 12. Check the following in terms of the recovery mode.



When operation stopped from a power failure and then power recovers, the unit will automatically resume operation.

See “P.44 Setting the recovery mode” for details.

### 13. Be sure to set a temperature of the Independent Overheat Prevention Device.



Must be set temperature of Independent Overheat Prevention Device (IOPD).

Note that temperature of this IOPD must be set to temperature over 30°C higher than Target Temperature.

Refer to Chapter 4. Operating Procedure –“Independent Overheat Prevention Device” for how to set and other cautions on page 50.



## 5. Handling precautions



Caution

### 14. Take care for the following in terms of the Gasket on Chamber.



Be aware of Gasket on Chamber that is made from silicon rubber and may vaporize benzoic acid, oil, etc. from volatile components of rubber used at their production during operation. Ask specific Gasket made from fluoro-rubber for samples that are not compatible with those chemicals.

Note that the rubber may be rusted or corroded by acids, alkaline, and halogenated solvent.

#### 【Caution】

Show substances that they will erode silicon rubber (standard specification) and fluoro-rubber (special specification) for Chamber Gasket on Table 5.1.

Never process samples that will be contained these substances showing on its Table.

Please contact with Yamato Scientific Customer Service Center for applicability of substances other than those listed below.

Table 5.1 - Typical substances eroding Gasket on Chamber

Material Classification	Silicon Rubber	Fluoro-rubber
Hydrocarbons	Butane, Isooctane, Benzene, Toluene, Xylene, Styrene, Diphenyl, Pinene, Kerosene	Propane
Halogen, Haloid Hydrocarbon	Methyl Chloride, Methylene Chloride, Chloroform, Carbon Tetrachloride, Trichloroethylene, Phlorobenzene, Monochloronaphthalene, R-11, R-12, R-21, R-22, R-113, R-114, Bromine	R-21, R-22
Ketone, Aldehyde	Methyl Ethyl Ketone, Diisopropyl Ketone, Diclhexanon, Acetophenone	Acetone, Methyl Ethyl Ketone, Methyl Isobutyl Ketone, Diisopropyl Ketone, Diclhexanon, Acetophenone
Ester	Methyl Acetate, Ethyl Acetate, Propyl Acetate, Butyl Acetate, Amyl Acetate, Methyl Acetoacetate, Butyl Acrylate, Ethyl Methacrylate	Methyl Acetate, Ethyl Acetate, Propyl Acetate, Isopropyl Acetate, Butyl Acetate, Amyl Acetate, Ethyl Acetoacetate, Ethyl Acrylate, Butyl Acrylate, Ethyl Methacrylate
Ether	Diethyl Ether, Dibutyl Ether, Ethylene Oxide, Dioxane, Epichlorohydrin, Tetrahydrofuran	Diethyl Ether, Isopropyl Ether, Dibutyl Ether, Dibenzyl Ether, Ethylene Oxide, Dioxane, Epichlorohydrin, Furfural, Tetrahydrofuran
Alcohol	Amyl alcohol	
Multiple Alcohol Derivative		Cellosolve Acetate, Butyl Cellosolve, Triacetin

## 5. Handling precautions



Caution

Material Classification	Silicon Rubber	Fluoro-rubber
Fatty Acid, Phenol	Acetic Anhydride, Oleic Acid, Phenol Palmitate	Formic Acid, Acetic Anhydride, Hydroquinone
Nitrogen Chemical Compounds	Nitromethane, Nitroethane, Nitropropane	Nitromethane, Nitroethane, Nitropropane, Ethylenediamine, Dimethylaniline, Ethanol amine, Hydrazine, Triethanol Amine, Dimethyl Formamide, Pyridine, Piperidine
Sulfur and phosphorus compounds	Hydrosulfuric	Hydrosulfuric, Tributyl Phosphate
Other Chemical Compounds	Nickel Acetate, Lead Acetate, Zinc Acetate, Tetraethyl Lead, Vegetable Oil, Silicon Oil	Calcium Acetate, Nickel Acetate, Lead Acetate, Zinc Acetate
Inorganic Solvent	Hydrochloric Acid, Nitric Acid, Sulfuric Acid, Hydrobromic Acid, Phosphoric Acid, Hypochlorous Acid, Chromic Acid, Perchloric Acid, Sodium Hydrate	Sodium Hydrate, Aqueous Ammonia

### 15. Never fail to perform periodic inspection.

- Check regularly Earth Leakage Breaker (ELB) and Independent Overheat Prevention Device (IOPD) which they are key part/Device for the safety of this Equipment. Refer to Chapter 6. Maintenance Method on page 57.

### 16. Take care for the following when operating the product with the suction port and the exhaust port covers fully open.

- Fully opening the suction port and the exhaust port covers may prevent the operating temperature from reaching the highest setting.

### 17. Take care for possible degradation of performance when using the cable port.

- When a measurement sensor or a probe is inserted into the cable port close the cable port cover as much as possible and completely seal to any gaps with heat-resistant packing or sealant. If seal is insufficient, the temperature characteristic, cleanliness or other performance will degrade. Use an optional silicon plug (with one hole) as necessary. See "P.64 List of optional settings".

### 18. Smoke may generate when you operate the unit for the first time.

- When you operate the unit for the first time, the bonding material of the heat insulation material may burn and generate odor, which, however, does not indicate a malfunction of the unit. Odor will not generate as you continue to use the unit for some time.

## 5. Handling precautions



### 19. During operation at a higher temperature

 Do not attempt to touch the inside of the unit and the door when you open the door during operation at a higher temperature. Also note that a fire alarm if installed around the unit may react.

### 20. About operation at a higher temperature

 After operation at a higher temperature, the inside of the unit and the door as well as the specimen will remain hot for a while. Take care not to touch those parts when putting or taking out specimen. Be sure to put on heat resistant gloves to avoid burning.

### 21. Never use thinner or alcohol to remove soil off the unit.

 Never apply any kinds of thinner and/or alcohol to wipe dirt off this Equipment. May come paint off, and may change its color or deform its shape, Otherwise. Note to turn Earth Leakage Breaker (ELB), off on the left side wall of this Equipment first, then maintain it.

### 22. About the ceiling of the main unit

 Avoid placing any objects on the ceiling of the models DNE401/411 and DNE601/611 except for stacking using the optional stacking clamps. And never place any objects on the ceiling of the models DNE811 and DNE911.

### 23. Be sure to read the operating instructions.

 Be sure to read the operating instructions before using the unit.

## 6. Maintenance method

### Daily inspection/maintenance



#### Warning

- Be sure to turn off Earth Leakage Breaker(ELB) of this Equipment before daily inspection and maintenance
- Inspect and maintenance this Equipment at ambient temperature on its Chamber.
- Never disassemble this Equipment.



#### Caution

- Wipe dirt off with wrung tightly soft cloth.
- Never clean this Equipment with benzene, thinner or scouring powder, or rub with a scrubbing brush.  
May cause deformation, degradation and/or discoloration.



#### Inspect monthly.

- **Inspect the ON and OFF functions of Earth Leakage Breaker(ELB).**
  - Prepare this Equipment for the inspection and connect Power Cord/Cable to receptacle or Switch Board of facilities.
  - Check ELB “OFF”, then turn ELB “ON ( | )”.
  - Press test button on ELB with ball-point pen etc. If ELB is shut down, ELB will be functional.
- **Check operation of Independent Overheat Prevention Device(IOPD).**
  - Be operating this Equipment at appropriate Target Temperature on Fixed Temperature Operation Mode.
  - Set this IOPD working temperature down to approximately 10°C lower than Read Temperature.
  - Activate this IOPD and will be shut power off heater circuit in few seconds, and display “Er07” on Top Screen, display warning sign “Overheat” on Bottom Screen, illuminate ERROR Lamp on Control Panel, and buzz on the same time.
  - \* Must check ELB and IOPD mentioned above prior to operate this Equipment for continuous long hours or unmanned operation during night time before starting operation.

◆Contact immediately with local dealer, Yamato sales office, or Yamato Customer Service Center for any questions.

## 7. Long storage and scrap

When not using the Equipment for a long time / when scrapping

 <b>Warning</b>	 <b>Caution</b>
Do not operate this Equipment for the time being. <ul style="list-style-type: none"> <li>● Turn Earth Leakage Breaker(ELB) off and disconnect Power Cord/Cable from receptacle /switch board of facilities.</li> </ul>	Scrap this Equipment. <ul style="list-style-type: none"> <li>● Do not leave this Equipment alone where children may play and get at it.</li> <li>● Before discarding the equipment, be sure to remove the hinge and the door lock assembly so that you cannot close the door hermetically.</li> </ul>

### Matters to consider when scrapping the Equipment

Pay attention always to the preservation of the global environment.

We, as Yamato Scientific Co., Ltd. highly recommend taking this Equipment apart as far as possible for separation or recycling to contribute to the preservation of the global environment according to the specified garbage collection method stipulated by each local government..

List major components and their materials for this Equipment as follows:

Names of major parts	Material
<b>Major components of the Equipment</b>	
External Structure	Chrome free electrogalvanized carbon steel sheet coated w/Chemical-proof baking finish
Chamber	Stainless steel plate
Heat Insulator	Ceramic fiber + glass wool
Door packing	Silicon rubber
<b>Major components of electrical parts</b>	
Switch and Relay	Composite of resin, copper and other materials
Operation Panel	Polycarbonate resin
Printed Circuit Boards	Composite of fiber glass and other materials
Heater	Stainless steel pipe
Power Cord/Cable	Composite of synthesized rubber coating, copper, nickel and other compound materials
Wires	Composite of fiber glass, fire-retardant vinyl, copper, nickel and other materials
Stickers	Resin materials
Sensor (K thermo-couple)	Stainless steel and others

## 8. When a trouble occurs

### Message error table

Show the error codes on Table 8.1 below.

Buzz and stop its operation at occurring errors on this Equipment.

Pressing any key (except for the  key) will stop the buzzer sound. When three minutes have passed as it is, the buzzer starts to sound again.

The Top screen shows an error code and the Bottom screen shows the error name. Note the error code, immediately turn power off and stop operating the unit.

Table 8.1 Table of Error Code

Error Display	Error Code Name	Causes and their solutions
ER01 SENS	Sensor Failure	<ul style="list-style-type: none"> <li>● Fail in temperature sensor.</li> <li>● Open circuit on temperature sensor line.</li> <li>● Detect temperature out of its designed range.</li> </ul> Contact original dealer of purchase.
ER02 TRIAC	TRIAC short circuit error	<ul style="list-style-type: none"> <li>● Short on TRIAC circuit.</li> <li>● Fail on Current Transformation (CT) sensor.</li> </ul> Contact original dealer of purchase.
ER03 HEAT	Heater Line Disconnection	<ul style="list-style-type: none"> <li>● Heater Line Disconnection</li> <li>● Fail on Current Transformation (CT) sensor.</li> <li>● The source voltage has dropped.</li> </ul> Contact original dealer of purchase.
ER07 OHEAT	Independent Overheat Prevention Device(IOPD) activated	<ul style="list-style-type: none"> <li>● Activate Independent Overheat Prevention Device (IOPD).</li> </ul> Turn ELB on again and check both Chamber temperature and setting Temperature of IOPD. Contact original dealer of purchase, if this Equipment is not energized at ELB on.
ER10 RELAY	Main Relay Contact melted	Check at turning ELB on again: <ul style="list-style-type: none"> <li>● Melt down the contact point of Main Relay.</li> <li>● Fail on Current Transformation (CT) sensor(s).</li> </ul> Contact original dealer of purchase.
ER14 RAM	RAM Failure Reduced capacity or end of use life of the backup battery	Check at turning ELB on again: <ul style="list-style-type: none"> <li>● RAM Failure : Reset power once.</li> <li>● Reduced capacity or end of use life of the backup battery :</li> </ul> Contact original dealer of purchase, if this error cannot be reset by ELB on. Must be replaced backup battery.
ER15 EPROM	EEPROM Failure	Check at turning ELB on again: <ul style="list-style-type: none"> <li>● Change its data code on EEPROM.</li> </ul> Contact original dealer of purchase, if this error cannot be reset by ELB on. Must be replaced backup battery.

## 8. When a trouble occurs

### Troubleshooting

Show troubleshooting guide on Table 8.2.

Refer to “Cause and their solutions” of Table 8.1 – Error Code on this Chapter “Message Error Table” at

Table 8.2 - Troubleshooting Guide

Phenomena	Causes	Solutions
Do not display current time on Bottom Screen at Earth Leakage Breaker (ELB) ON.	<ul style="list-style-type: none"> <li>▪ Do not supply power.</li> <li>▪ Fail ELB.</li> <li>▪ Fail Controller.</li> </ul>	<ul style="list-style-type: none"> <li>▪ Check connection to power supply and apply power.</li> <li>▪ Replace ELB.</li> <li>▪ Replace Controller.</li> </ul>
Do not display anything on both Top and Bottom Screen at Controller Power key pressed and held.	<ul style="list-style-type: none"> <li>▪ Fail supplied power. (Required Voltage <math>\pm 10\%</math>)</li> <li>▪ Fail Controller.</li> </ul>	<ul style="list-style-type: none"> <li>▪ Connect to adequate power supply.</li> <li>▪ Replace Controller.</li> </ul>
Do not rise Chamber temperature.	<ul style="list-style-type: none"> <li>▪ Activate IOPD and /or Self-diagnosis Function built-in on Controller, and shut heater circuit down (Error code displayed).</li> </ul>	<ul style="list-style-type: none"> <li>▪ Refer to “Cause and their solutions” of Table 8.1 – Error Code on page 59.</li> </ul>
Display temperature unstable.	<ul style="list-style-type: none"> <li>▪ Fluctuate ambient temperature heavily.</li> <li>▪ Fail supplied power. (Required Voltage <math>\pm 10\%</math>)</li> <li>▪ Fail Controller.</li> <li>▪ Fail Temperature Sensor</li> <li>▪ Be affected by samples.</li> </ul>	<ul style="list-style-type: none"> <li>▪ Review its location.</li> <li>▪ Connect to adequate power supply.</li> <li>▪ Replace Controller.</li> <li>▪ Replace Temperature Sensor.</li> <li>▪ See “P.53 15. Take care for processing of powder and small samples”.</li> </ul>

Contact with local dealer or Yamato Customer Service Center phenomena other than Table 8.2 above.

## 9. After sales service and warranty

### Request to repair parts

#### Request to repair parts は

When any abnormality occurs immediately stop operation, turn the controller power and the ELB off and contact your dealer, one of our sales offices.

Require the following information for repair.

- Model name of Yamato products
- Serial Number
- Date (year/month/date) of purchase
- Description of trouble in detail as possible

See Warranty Card or caution rating nameplate on this Equipment.  
(See Chapter 3. Names and functions of each part “on page 7 for details.

Be sure to present the warranty card to Yamato service representative.

#### Guarantee for maximum storage period of repair parts.

Guarantee that maximum storage period of repair parts will be 7(seven) years after end of their production, Forced Convection Constant Temperature Oven DNE401/411, E601/611, NE811, E911.  
Repair parts will be defined the parts to maintain this Equipment performance.



# 10. Specifications

## Specifications

Product Name		Forced Convection Constant Temperature Oven					
Model Name		DNE401	DNE411	DNE601	DNE611	DNE811	DNE911
System		Forced wind circulation and ventilation					
Operating environment temperature range		5°C~35°C					
Power supply		Single phase AC115V	Single phase AC220V	Single phase AC115V	Single phase AC220V	Single phase AC220V	
		10A	5.5A	11A	6A	11.5A	14A
		Common to 50/60Hz, operating voltage range : ±10%					
Performance ※1	Temperature Control Range	Room temp.+20°C~210°C			Room temp.+15°C~210°C		
	Temperature control precision	±0.5°C (at 210°C) JTM K05					
	Temperature fluctuation ※2	±0.6°C (at 210°C) JIS C60068					
	Temperature distribution precision	±2.0°C (at 210°C) JTM K05					
	Temperature slope	6°C (at 210°C) JIS C60068	8°C (at 210°C) JIS C60068	8°C (at 210°C) JIS C60068	10°C (at 210°C) JIS C60068		
	Temperature rise time	Approx.60 min.	Approx.70 min.	Approx.45 min.	Approx.60 min.		
Composition	Exterior	Chrome-free electro-galvanized steel plate Chemical proof baking finish					
	Chamber	Stainless steel plate					
	Insulation Material	Glass wool					
	Door	Single swing (left side)				Hinged double doors	
	Heater	Stainless steel pipe heater					
	Heater capacity	1.1kW	1.2kW	1.2kW×2	1.5kW×2		
	Fan (motor)	Cirroco fan (capacitor motor)					
		10W		30W		30W×2	
	Heater capacity	I.D.φ33mm (lower part on the right side)					
	Suction port	I.D.φ33mm (lower part on the right side)					
	Exhaust port	I.D. φ33mm×2 (ceiling)			I.D.φ33mm×2(rear)		
	Caster wheels	—			Free swivel caster wheels (w/o stoppers)		
Adjuster	—			Level adjusters (2 at the front)			
Controller	Type	V-shaped controller					
	Temperature Control Method	PID Z control					
	Temperature setting method	Digital setting with ▲/▼ keys.					
	Temperature Display Method	Top Screen (Chamber) : Green 4-digit LED Digital Display (Resolution : 1°C)					
		Bottom Screen : Orange 5-digit LED Digital Display (Resolution : 1°C)					
	Other displays	LED indicates temperature patterns for heating/stable/cooling					
	Timer	Settable between 1 minute and 99 hours 59 minutes: duration operation 24 hour setting: time operation					
Operating function	Fixed temperature operation Program operation (Maximum 99 steps, up to 99 patterns, the repeat operation function) Duration/time select timer operation function (Fixed temperature operation auto start/auto stop/quick auto stop, program operation auto start)						

# 10. Specifications

## Specifications

Model		DNE401	DNE411	DNE601	DNE611	DNE811	DNE911
Controller	Additional function	Power on and Operation Time Integrating Function(up to 65,535 hours); Calibration Offset; Monitor Display of Integrated Power Consumption, Total CO2 Emission, and Heater operating Output; Power Recovery Mode; Save and Access of Operator's Setting Information;					
	Heater Control	Triac with Zero-cross Control					
	Sensor	K type Thermocouple (for temperature control and independent overheat preventive device)					
Safety Device	Controller	Self-diagnosis Functions (Temp. Sensor Failure Detection, TRIAC Short Circuit, Heater Line Disconnection, Fan Failure Detection, Main Relay Contact Melted, Automatic Overheat Prevention), Key Lock Function					
	Earth Leakage Breaker(ELB)	15A	10A	15A	10A	15A	20A
	Independent Overheat Prevention Device(IOPD)	Leak Current/Short Circuit/Over-current Protection, Rated Sensitivity Current 30mA  Set Temperature Range : 0~250°C					
Standard	Internal dimensions	450mm		600mm		600mm	1090mm
	※3 Width	450mm		500mm		500mm	500mm
	※3 Depth	450mm		500mm		1000mm	1000mm
	※3 Height						
	External dimensions	580mm		730mm		730mm	1220mm
	※3 Width	645mm		695mm		695mm	695mm
※3 Depth	860mm		910mm		1660mm	1660mm	
※3 Height							
Internal capacity	90ℓ		150ℓ		300ℓ		540ℓ
Weight	Approx. 63kg		Approx. 77kg		Approx. 92kg		Approx. 185kg
Number of tiers/shelf support pitch	11 tiers /30mm		13 tiers /30mm		29 tiers /30mm		29 tiers /30mm × 2
Withstand load of each shelf board	Approx. 15kg/board						
Accessories	Shelf board material	Stainless steel punched plate (The bottom plate is held with screws, the model DNE911 includes two plates)					
	Qty of shelf boards/shelf pegs	2/4			4/8		8/16
	Instruction Manual	This manual, 1 copy					
	Warranty card	1 copy					
Article	※1 Performance data has been measured at the rated source voltage of single phase AC115V±5% or AC220V±5%, room temperature of 23°C±5°C, relative humidity of 65%RH±20%, all of the exhaust, suction, and cable ports fully closed and no-load. ※2 The value is calculated by dividing the measured value to JIS by 2. ※3 Protrusions are excluded.						

# 11. Accessory

## List of accessories

Show the list of optional accessories for this Equipment on Tables 11. 1 and 11. 2. 1\_2

Forced Convection Constant Temperature Oven DNE401/411, DNE601/611, DNE811, DNE911 support a wide variety of optional parts.

※Note that some optional parts may not be installed after delivery.

Table 11. 1 List of Options (installation possible after delivery)

Option	Product Code No.	Model Name	Applicable model	Remarks
Stand	211856	ON61	DNE401/411 DNE601/611	The main unit can be secured to the stand for operation.
	212348	OT42	DNE401/411	
	212349	OT62	DNE601/611	
Stacking clamp	212806	ODN26	DNE401/411	You can stack two main units on top of the other. Contact us for possible combinations with other series.
	212807	ODN28	DNE601/611	
Shelf boards (1, 2 shelf pegs are included)	212246	ODN20	DNE401/411	Shelf boards of the same type as the standard shelf boards for adding.
	212266	ODN22	DNE610/611 DNE811	
	212490	—	DNE911	
Anti-seismic mat “Labopita” 1 set includes 4 mats	296902	—	DNE401/411 DNE601/611	Prevents falling down simply by putting on the bottom of a device.
Seath sensor (K thermocouple)	212946	ODT48	Common to all models	Temperature sensor for confirming the temperature in the chamber or of samples.
Silicon plug (with one hole)	212947	ODT52	Common to all models	This silicon rubber plug for fixing and sealing gap of sensors inserted from the cable port. There is a $\phi$ 2mm hole at the center of it.

Table 11. 2. 1 List of options (installation not possible after delivery)

Option	Product Code No.	Model Name	Applicable model	Remarks
External Communication Adaptor Set	211880	0IN90	Common for all models	Connect this Equipment with PC through this adaptor for external communication. Attach application software to this Set.
External communication terminal (RS485)	281442	ODM12	DNE401/411 601/611/811	Monitor operation state of this Equipment and control it remotely.
	281443	ODM14	DNE911	
External Communication Adaptor Set	281444	ODM16	DNE401/411 601/611/811	Connect this Equipment with PC through this adaptor for external communication. Attach application software to this Set.
	281445	ODM18	DNE911	

# 11. Accessory

## List of accessories

Table 11.2.2 List of optional settings (Cannot be installed after delivery)

Option	Product Code No.	Model Name	Applicable model	Remarks
External Alarm Output Terminal	281446	ODM20	DNE401/411 601/611/811	Output alarm signal at occurring error on this Equipment. Display its particular error on Bottom Screen.
	281447	ODM22	DNE911	
Timeup Output Terminal Operation Signal Output Terminal	281448	ODM24	DNE401/411 601/611/811	Output timeup signal "END" at the end of Automatic Stop Operation and/or Program Operation and displaying it on Bottom Screen.
	281449	ODM26	DNE911	
Event Output Terminal Timeup Output Terminal	281450	ODM28	DNE401/411 601/611/811	Output operation signal at being operated of this Equipment.
	281451	ODM30	DNE911	
Operation Signal Output Terminal	281452	ODM32	DNE401/411 601/611/811	Output ON-OFF signal set at each state such as standby, being operated, end of operation, and program steps.
	281453	ODM34	DNE911	
Cable hole (Internal dia.φ25mm)	281454	ODM36	Common for all models	Consult us for the position and the number of ports. Combination of φ25mm and φ50mm ports is possible.
Cable hole (Internal dia.φ50mm)	281455	ODM38	Common for all models	
Observation window	281456	ODM40	DNE401/411	An observation window (W250mm x H280mm) (reinforced glass) can be made at the center of the door. Note that the performance is not guaranteed for the unit with a window.
	281457	ODM42	DNE601/611	

These options may be installed or created after delivery or installation of the unit. Consult your dealer or one of our sales offices for optional parts.

# 12. Wiring diagram

DNE401/601 Wiring diagram

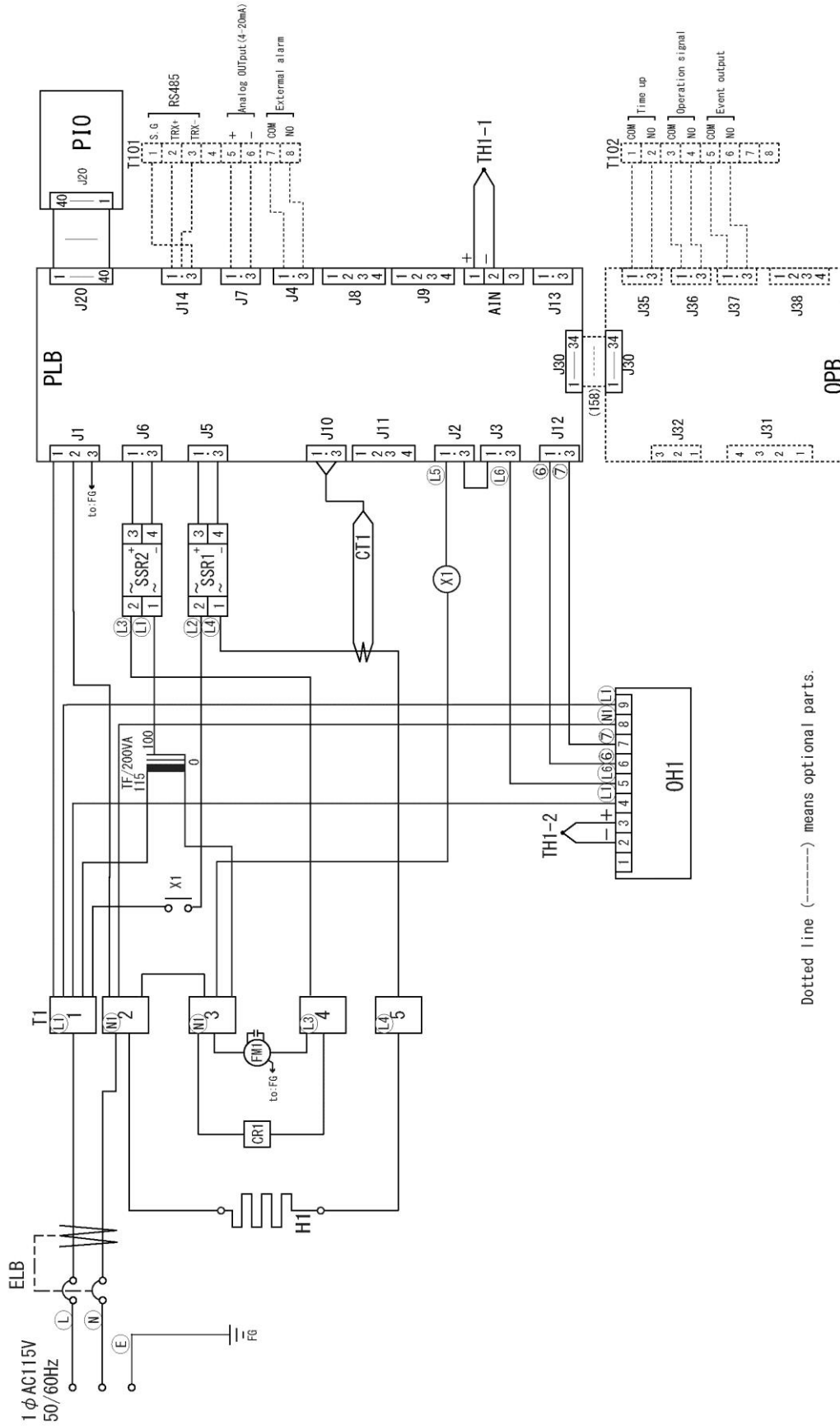

Dotted line (-----) means optional parts.

# 12. Wiring diagram

## DNE411/611 Wiring diagram

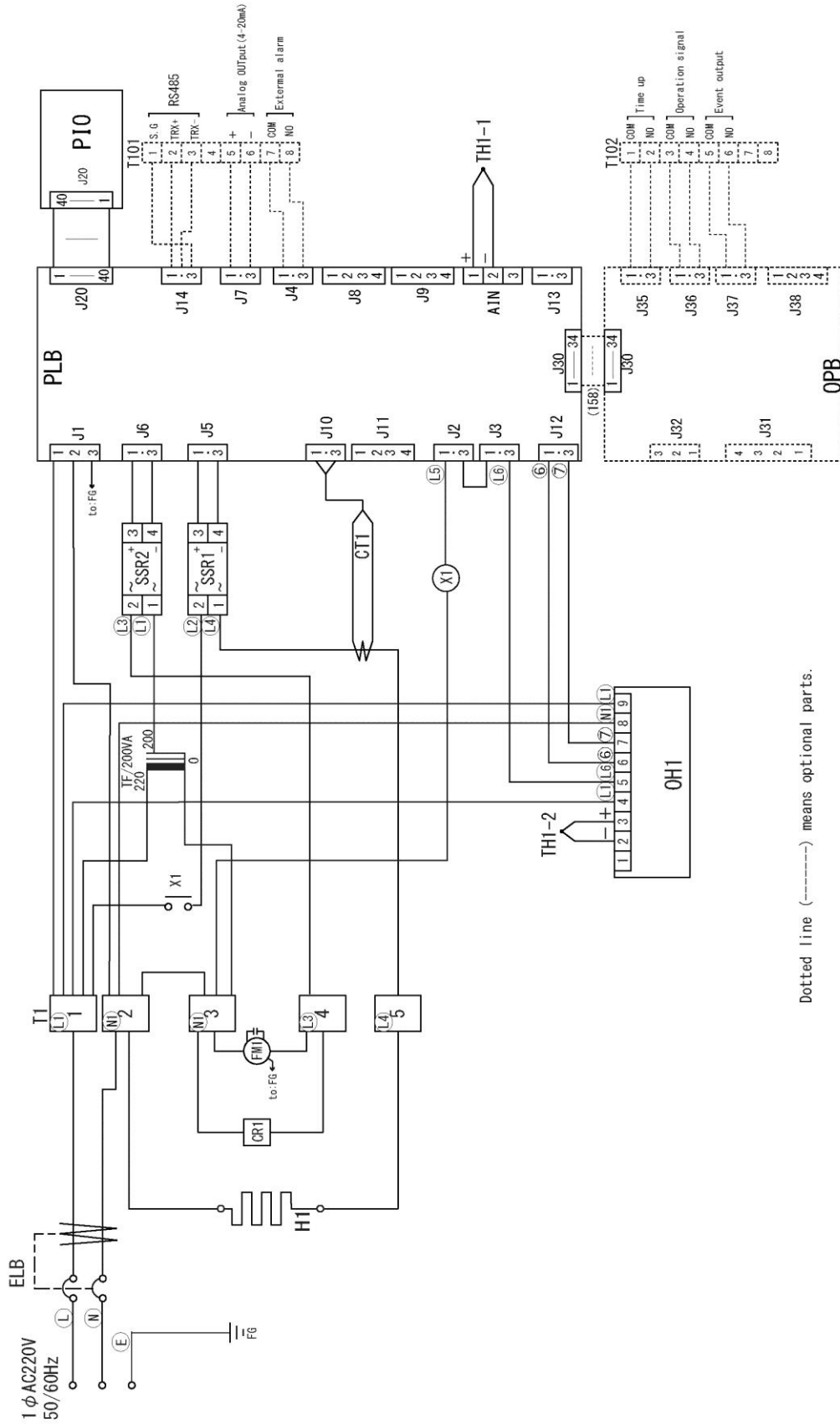

# 12. Wiring diagram

## DNE811 Wiring diagram

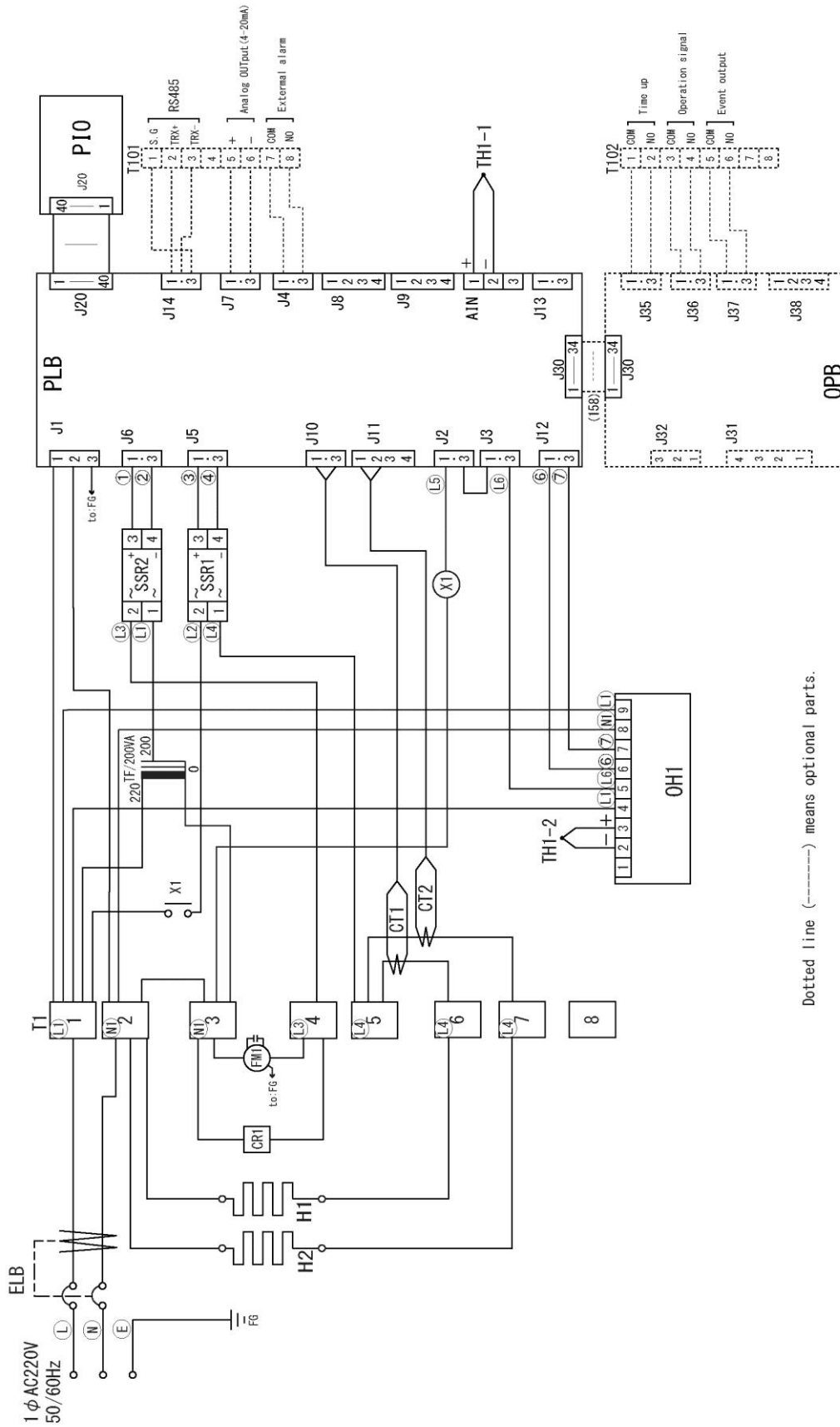

# 12. Wiring diagram

DNE911 Wiring diagram

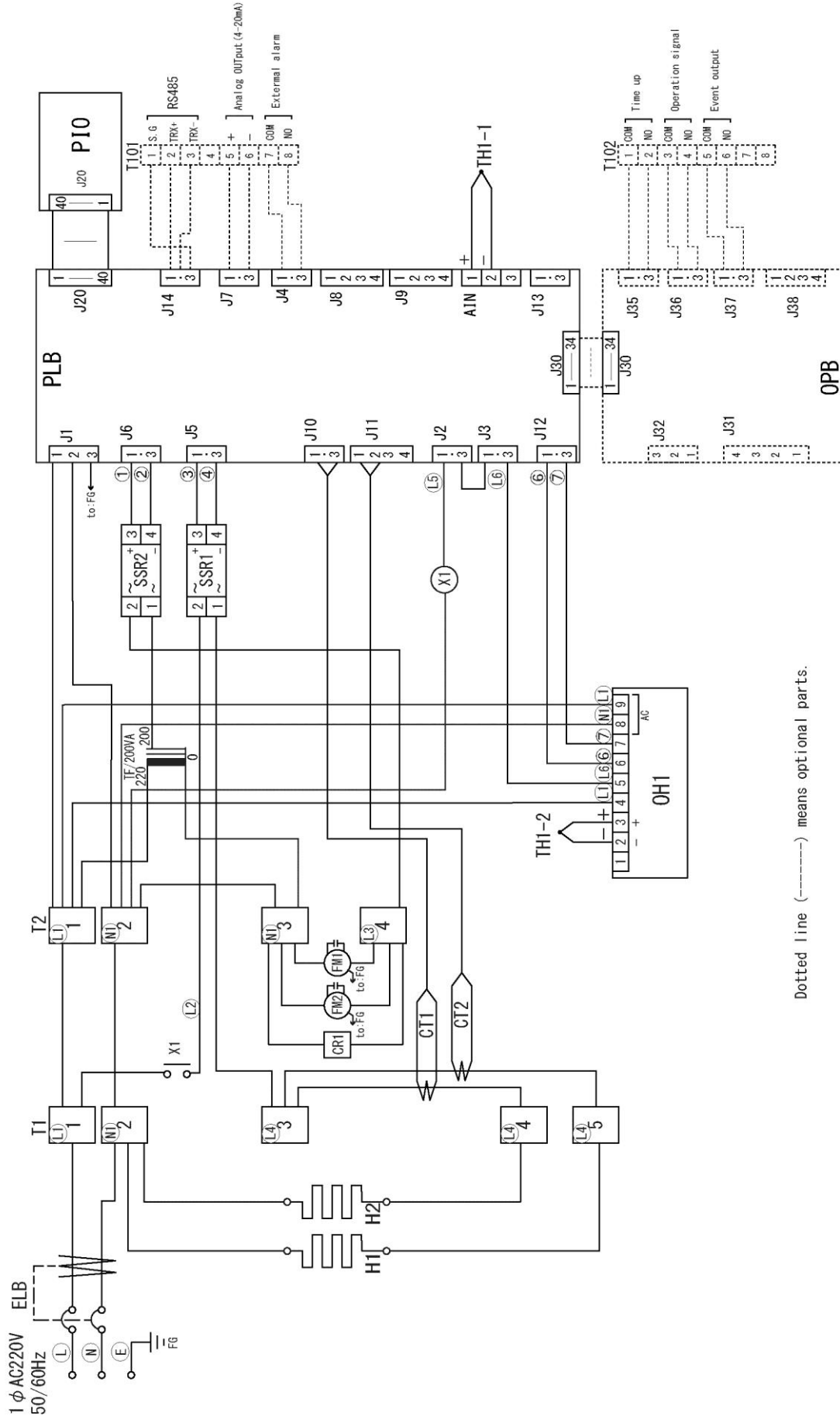



# 12. Wiring diagram

## Wiring diagram part symbols

Symbol	Nomenclature	Symbol	Nomenclature
ELB	Earth Leakage Breaker(ELB)	PI0	V type Display Board
T1	Terminal Block for wiring	OH1	Independent Overheat Prevention Device
T2	Terminal Block for wiring	TH1-1	Sensor for Independent Overheat Prevention Device
X1	Main Relay	TH1-2	Sensor for temperature control
SSR1、2	Solid State Relay	TF	Transformer
H1、2	Heater		
CT1、2	Current Sensing Element		
CR1	Spark Killer		
FM1、2	Fan Motor		
PLB	V type Planar Board		

### Optional parts

Symbol	Nomenclature	Symbol	Nomenclature
OPB	V type Optional Board		
T101	Terminal Block for external output		
T102	Terminal Block for external output		

## 13. List of dangerous substances



**Never process any explosive, flammable samples and also samples contained with those substances.**

Explosive Substances	① Nitroglycol, Glycerine trinitrate, Cellulose Nitrate and other explosive nitrate esters
	② Trinitrobenzen, Trinitrotoluene, Picric Acid and other explosive nitro compounds
	③ Acetyl Hydroperoxide, Methyl Ethyl Ketone Peroxide, Benzoyl Peroxide and other organic peroxides
	④ Metallic Azide, including Sodium Azide, etc.
Explosive Substances	① Metal "Lithium" ② Metal "Potassium" ③ Metal "Natrium" ④ Yellow Phosphorus
	⑤ Phosphorus Sulfide ⑥ Red Phosphorus ⑦ Phosphorus Sulfide
	⑧ Celluloids, Calcium Carbide (a.k.a, Carbide) ⑨ Lime Phosphide ⑩ Magnesium Powder
	⑪ Aluminum Powder ⑫ Metal Powder other than Magnesium and Aluminum Powder
	⑬ Sodium Dithionous Acid (a.k.a., Hydrosulphite)
Oxidizing Substances	① Potassium Chlorate, Sodium Chlorate, Ammonium Chlorate, and other chlorates
	② Potassium Perchlorate, Sodium Perchlorate, Ammonium Perchlorate, and other perchlorates
	③ Potassium Peroxide, Sodium Peroxide, Barium Peroxide, and other inorganic peroxides
	④ Potassium Nitrate, Sodium Nitrate, Ammonium Nitrate, and other nitrates
	⑤ Sodium Chlorite and other chlorites
	⑥ Calcium Hypochlorite and other hypochlorites
Flammable Substances	① Ethyl Ether, Gasoline, Acetaldehyde, Propylene Chloride, Carbon Disulfide, and other substances with ignition point at a degree 30 or more degrees below zero.
	② n-hexane, Ethylene Oxide, Acetone, Benzene, Methyl Ethyl Ketone and other substances with ignition point between 30 degrees below zero and less than zero.
	③ Methanol, Ethanol, Xylene, Pentyl n-acetate, (a.k.a. amyl n-acetate) and other substances with ignition point between zero and less than 30 degrees.
	④ Kerosene, Light Oil, Terebinth Oil, Isopenthyl Alcohol (a.k.a. Isoamyl Alcohol), Acetic Acid and other substances with ignition point between 30 degrees and less than 65 degrees.
Combustible Gas	Hydrogen, Acetylene, Ethylene, Methane, Ethane, Propane, Butane and other gases combustible at 15°C at one air pressure.

Programming sheet

Control №

Model name		Date of preparation	(Y) (M) (D)
Program pattern number		Prepared by	

Set temperature

Program pattern

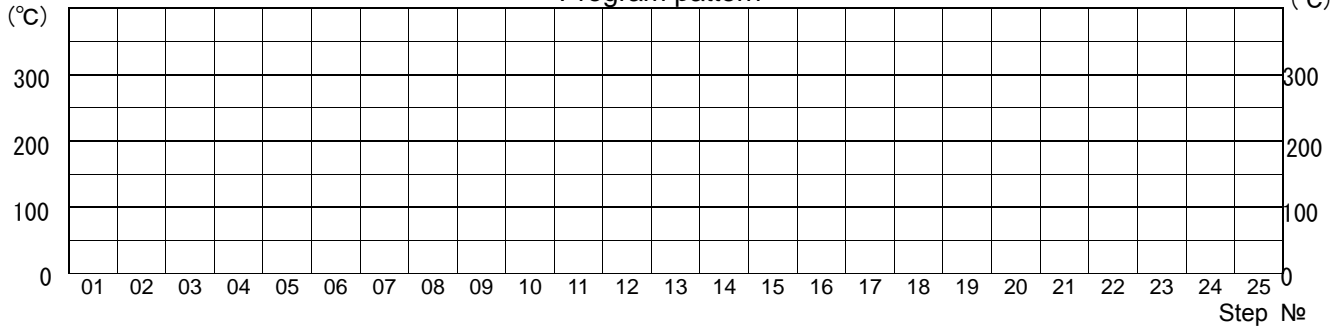

Pattern number	Step	Set temperature	Time	Repeat dstn	Number of repetitions	Wait	Event			End
<b>P** : 00</b>	<b>P02 : **</b>	<b>TEMP</b>	<b>TIME</b>	<b>REP</b>	<b>REP</b>	<b>WAIT</b>	<b>EVENT</b>			<b>END</b>
		(°C)	Hr : Min	STEP	COUNT	ON/OFF	1	2	3	:ST
	01		:							
	02		:							
	03		:							
	04		:							
	05		:							
	06		:							
	07		:							
	08		:							
	09		:							
	10		:							
	11		:							
	12		:							
	13		:							
	14		:							
	15		:							
	16		:							
	17		:							
	18		:							
	19		:							
	20		:							
	21		:							
	22		:							
	23		:							
	24		:							
	25		:							
Remarks										

Note: Event is optional item. Duplicate and use this sheet.

## Limited liability

**Be sure to use this Equipment strictly following the handling and operating instructions in this Instruction Manual.**

**Yamato Scientific Co., Ltd. assumes no responsibility for accident or malfunction caused by use of this Equipment in any way not specified in this Instruction Manual.**

**Never attempt to perform matters prohibited in this Instruction Manual.**

**Otherwise, unexpected accident may result.**

## Notice

- **Descriptions in this Instruction Manual are subject to change without notice.**
- **WE, as Yamato Scientific Co., Ltd. will replace this Instruction Manual with missing page or paging disorder.**

Operation Manual  
Forced Convection Constant Temperature Oven  
DNE401/411, DNE601/611, DNE811, DNE911  
First Edition July 16, 2015

---

## **Yamato Scientific America, Inc.**

925 Walsh Avenue, Santa Clara,  
CA 95050, U.S.A

<http://.yamato-usa.com>

[Tel:408-235-7725](tel:408-235-7725)