User Manual

High Voltage Differential Probe Series

Please read this manual carefully before use

Safety precautions

1. Be cautious of an electric shock
2. Pay attention to the maximum input voltage

Please do not use in humid or inflammable and explosive environment

DPB5000 Series High Voltage Differential Probe

DPB5000 Series Summary

Model	Maximum Input Voltage	Bandwidth	Attenuation Rate
DPB5150	1500V	70MHz	50X/500X
DPB5150A	1500V	100MHz	50X/500X
DPB5700	7000V	70MHz	100X/1000X
DPB5700A	7000V	100MHz	100X/1000X

Content

DPB5000 Series High Voltage Differential Probe.....	I
DPB5000 Series Summary	I
Overview	1
Application	1
Product and Accessories Description.....	2
Electric Specification	5
Mechanical Specification	6
Environment Characteristics	6
Operating the Probe Safely	7
Test Mode (Offset Setting)	7
Safety Notices.....	7
Performance Verification	8
DPB4080 High Voltage Differential Probe	11
DPB4080 Summary	11
Overview	11
Electric Specification.....	11
Operating environmental conditions.....	12
Operating procedure.....	12
Care and Maintenance.....	13
Contact SIGLENT	13

Overview

DPB5000 series high voltage differential probes are designed for the measurement of high voltage differential signal, to meet the demand for floating measurement. The bandwidth can be as high as 100MHz, meeting the demand for majority of measurement systems. There are a variety of ranges to choose from, and their differential voltage measurement range can meet with the demand for majority of tested circuits; users may go into test mode to adjust the offset voltage, and meanwhile to adjust automatically to prevent probes being disordered after years' of use; the electronic touch buttons give them longer working life; with function of 5MHz bandwidth limit selection, whose frequency bandwidth fits for the FETs switching frequency measurement in most switching power supplies, and they can filter out higher frequency noise and interference; with sound & light alarming function, which can also be closed manually, is more humanized designed; with USB power supply connector, easier and more flexible for use; the probes are equipped with standard BNC input connectors, can be used with any manufacturer oscilloscope (oscilloscope input impedance should set to 1M Ω ; when 50 Ω is selected, the attenuation multiply attenuates double.) to test waveform of the tested circuits; automatic save function, to prevent users re-operating in case of power supply drops. The probes have good capability of common mode noise suppression, can be widely used in the research and development, debugging or overhauling work for switching power supply, frequency converter, electronic ballast, frequency conversion electronic appliances and other electric power equipments.

Application

- Floating voltage measurement
- Frequency converter
- Switching power supplies designs
- Welding, plating power supplies
- Induction heating, electromagnetic oven
- Motor driven design
- Electronic ballast design
- CRT displayer design
- Inverter, UPS power supplies
- Frequency conversion electrical appliances
- Power conversion and related design
- Electrical engineering experiment
- Low voltage appliances experiment
- Power electronics and electric drive experiments

Product and Accessories Description

Probe body description

Take DPB5150A as an example, voltage, range and bandwidth are varied with different products.

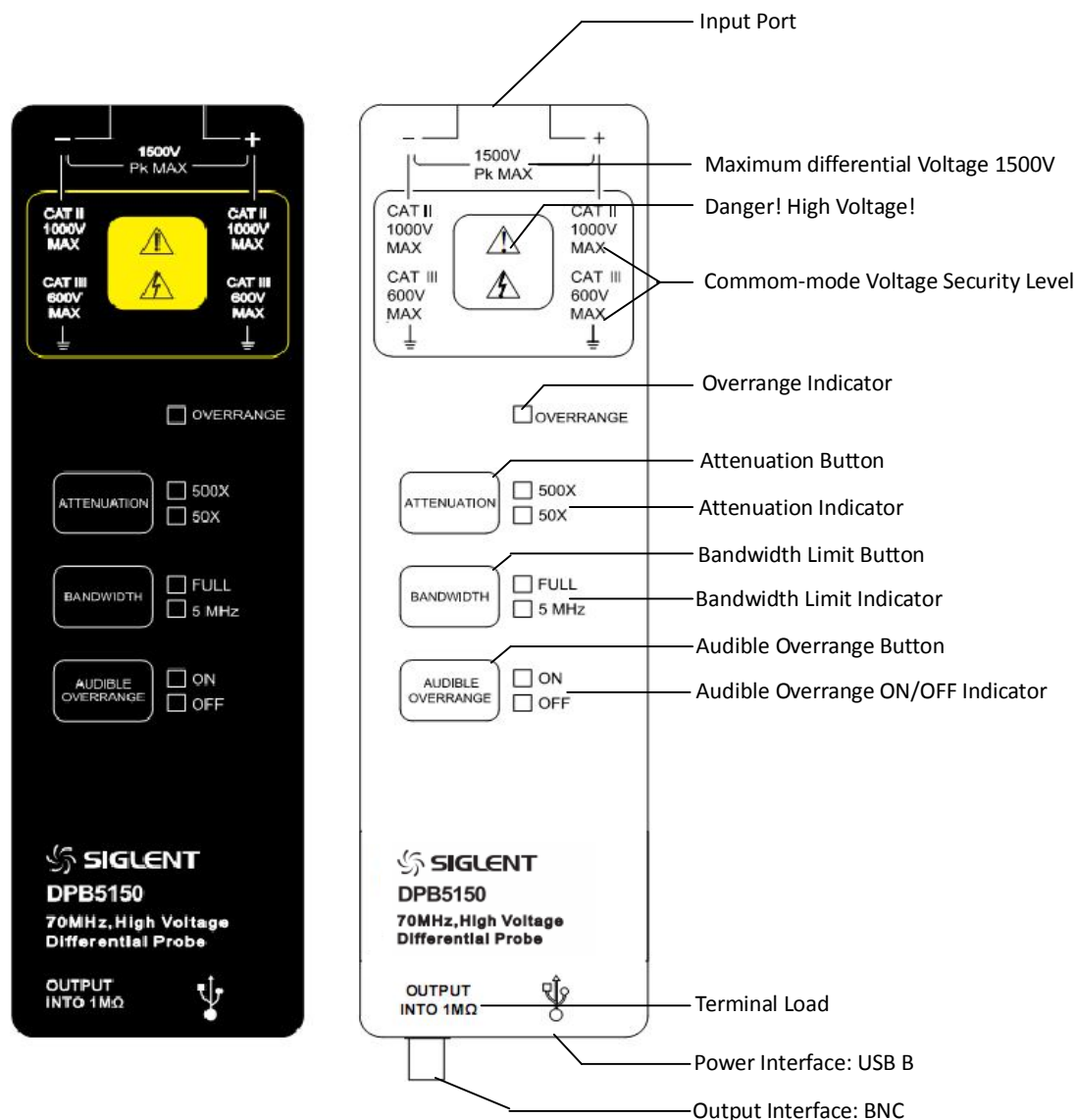

Detailed Description:

1. Input connector: Standard red and black socket. Red is positive, black negative, output will reverse when is reversely connected; use together with standard red black input cables.
2. ATTENUATION: Different attenuation indicates different ranges, such as

DPB5150A: 500X indicate the maximum test voltage is 1500V;

50X indicate the maximum test voltage is 150V;

DPB5700A: 1000X indicates maximum test voltage is 7000V;

100X indicates maximum test voltage is 700V;

Oscilloscope attenuation factor should be set accordingly based on the probe attenuation selection .

3. BANDWIDTH: The series products have bandwidth selection function; the default is full bandwidth (FULL) of the product. When testing low frequency signal, you can choose 5MHz bandwidth limit to prevent being interfered by high frequency signal.
4. AUDIBLE OVERRANGE: When test range exceeds probe range, audible and visual alarm will start; the function is to control buzzer alarm on or off, ON is to open audible alarm and OFF closes the alarm.
5. Output connector: Standard BNC input connectors, can be connected to any manufacturer oscilloscope, oscilloscope input impedance should set to 1MΩ; if set to 50Ω, the output attenuation is a half of the practical value.
6. Power interface: Standard USB type B interface, supply power with standard USB adapter; can be supplied by oscilloscope, easy to use; also can be supplied by portable power source, convenient for outdoor test.
7. Factory Setting: The default factory setting is high attenuation ratio, FULL bandwidth, audible alarm is on. The product has automatic memory, automatically save the state before power off.

Accessories Description



Alligator Clips (CK-261 red black 1 pair)



Alligator Clips (CK-262 red black 1 pair)



Pincer Clips (CK-281 red black 1 pair)

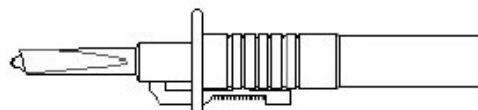

Hook Clips (CK-284 red black 1 pair)



Input differential lead (CK-28 one pair)

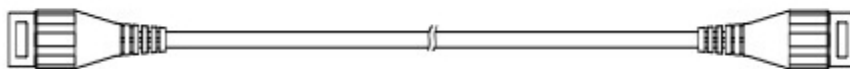

Coaxial Output Line(CK-310)

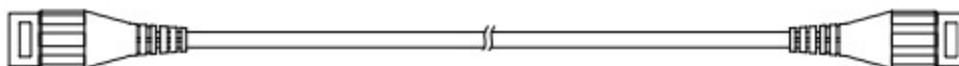

Coaxial Output Line(CK-320)

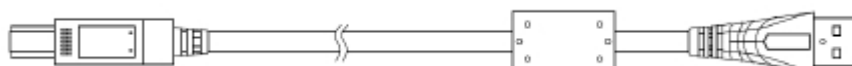

USB line (CK-315 AM-BM, 1.5m)

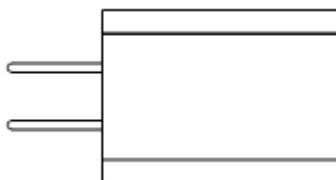

Power adapter (CK-605) USB 5V/1A

Product standard accessories description

Model	DPB5150	DPB5150A	DPB5700	DPB5700A
Alligator Clips (CK-261)	CATIII 1000V CATIV 600V	CATIII 1000V CATIV 600V	---	---
Alligator Clips (CK-262)	---	---	CATIII 1000V CATIV 600V	CATIII 1000V CATIV 600V
Pincer Clips (CK-281)	CATIII 1000V	CATIII 1000V	CATIII 1000V	CATIII 1000V
Hook Clips (CK-284)	CATIII 1000V	CATIII 1000V	CATIII 1000V	CATIII 1000V
High Voltage Input differential lead (CK-28)	10A CATIII 1000V	10A CATIII 1000V	10A CATIII 1000V	10A CATIII 1000V
Coaxial Output Line (CK-310)	Double-ended BNC connector coaxial line 1m (Standard accessories)			
Coaxial Output Line (CK-320)	Double-ended BNC connector coaxial line 2m (non-standard, purchased individually)			
USB line (CK-315)	AM-BM, 1.5 m			
Power adapter (CK-605)	USB 5V/1A			

NOTE: The above “---” refers to non-standard accessory of this model

Electric Specification

Model		DPB5150	DPB5150A	DPB5700	DPB5700A
BW (-3dB)		DC-70MHz	DC-100MHz	DC-70MHz	DC-100MHz
Rise time		≤5ns	≤3.5ns	≤5ns	≤3.5ns
Accuracy		±2%	±2%	±2%	±2%
Attenuation Rate		50X/500X		100X/1000X	
Max Differential Test Voltage (DC + Peak AC)		50X: 150V		100X: 700V	
		500X: 1500V		1000X: 7000V	
Max input common mode voltage(voltage-to-earth Vrms)		600V CATIII 1000V CATII		1000V CATIII 2300V CATII	
Input Impedance	Single-ended to ground	5MΩ	5MΩ	20MΩ	20MΩ
	Two inputs	10MΩ	10MΩ	40MΩ	40MΩ
Input Capacitance	Single-ended to ground	<4pF	<4pF	<5pF	<5pF
	Two inputs	<2pF	<2pF	<2.5pF	<2.5pF
CMRR	DC	>80dB	>80dB	>80dB	>80dB
	100kHz	>60dB	>60dB	>60dB	>60dB
	1MHz	>50dB	>50dB	>50dB	>50dB
Noise (Vrms)		50X: <50mV 500X: <50mV		100X: <200mV 1000X: <1.2V	
propagation delay (standard 1 m output lead)		18ns±1ns		18ns±1ns	
Bandwidth limit(5MHz)		≥-3dB@5MHz		≥-3dB@5MHz	
Differential overvoltage detection level		50X: ≥150V 500X: ≥1500V		100X: ≥700V 1000X: ≥7000V	
Overload indicator (red light)		YES			
Overload Alarm		Yes(Can shut up manually)			
Automatic Save		YES			
Offset Setting function		Yes (Set in test mode)			
Terminate Load		1MΩ			
Power Supply		USB 5V/1A adapter			

Mechanical Specification

Model		DPB5150	DPB5150A	DPB5700	DPB5700A
Differential Input lead	CK-28	Approx 28 cm			
Output Lead	CK-310	Approx 1 m			
	CK-320	Approx 2 m			
Alligator Clips CK-261		Approx 85*40*17 mm			
Alligator Clips CK-261		Approx 106*43*16 mm			
Pincer Clips CK-281		Approx 152*50*13 mm			
Hook Clips CK-284		Approx 121*23*23 mm			
Probe body dimensions		195*65*28 mm			
Probe body weight		Approx 188 g		Approx 190 g	

Environment Characteristics

Model	DPB5150	DPB5150A	DPB5700	DPB5700A
Operating Temperature	0~50℃			
Nonoperating Temperature	-30~70℃			
Operating Humidity	≤85%RH			
Nonoperating Humidity	≤90%RH			
Operating Altitude	3000m			
Nonoperating Altitude	12000m			

Operating the Probe Safely

- 1) You should estimate the tested voltage amplitude before testing, please do not use if exceeds the voltage range, because probably the probe will be damaged.
- 2) Connect the input lead and output lead to the probe; and then connect the probe to oscilloscope or other instruments.
- 3) Connect the power adapter to voltage probe, the power indicator light turns on green. Please select proper range based on the tested voltage; when the tested voltage exceeds range, the overload indicator light is on with alarming sound, which can be manually turned off.
- 4) Please set proper attenuation rate for the oscilloscope or other instruments according to the probe range; and adjust the oscilloscope sensitivity based on the tested voltage.
- 5) Connect the probe clips based on needs, start after connecting to the circuits to be tested. When testing, the probe body should keep away from high voltage pulse circuits to reduce interference to the probe.

Test Mode (Offset Setting)

Users may enter the test mode to adjust offset based on needs; the probes may be disordered after years' of use. The adjustment method is as follows if not in zero:

- ① Please press these two keys **ATTENUATION** **BANDWIDTH**, and make short circuits for input terminals.
- ② Turn power on to start, entering test mode, and the overload indicator light is on, release the two keys.
- ③ Go into the high attenuation factor offset adjustments under the state, press the key **ATTENUATION** offset increase; press **BANDWIDTH**, offset decrease.
- ④ After the adjustment, press key **AUDIBLE OVERRANGE** to switch to low attenuation ratio offset adjustment, press key **ATTENUATION**, offset increases; press **BANDWIDTH**, offset decreases.
- ⑤ After the above step, press key **AUDIBLE OVERRANGE** to exit the test mode, offset adjustment is completed and the overload indicator light off, entering into normal operation mode.

Safety Notices

1. Please try to wind the input leads when testing, which is better for eliminating noise, to improve the ability of high frequency response. Please view below for the winding method:

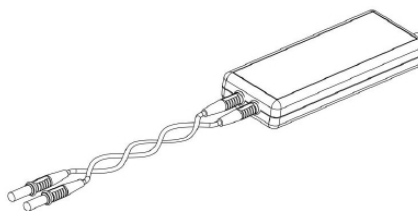

2. It is better not to extend input lead when testing; otherwise it may introduce more noise. If extra extension lead is necessary, please ensure the extension leads are at same length, and the input frequency is under 10MHz, errors may exist if exceeds 10MHz output.

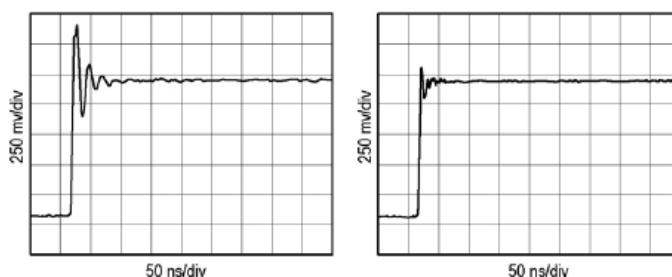

HF transient response with (left) and without (right) extension leads

Performance Verification

The below operation is for performance verification of the electric specification, requirement for test equipments is shown below:

Equipments	Minimum Requirements	Usages
Oscilloscope	Bandwidth \geq 100MHZ;Accuracy \cong 1.5%, e.g.:Tektronix MSO/DSO4000	Displays probe output
Standard signal Generator or calibrator	Amplitude accuracy \leq 0.75%;rise times \leq 3ns e.g.: FLUKE/WAVETEK 9100	Test bandwidth; AC accuracy; Common mode rejection
Digital multimeter	Accuracy of not less than 6 and a half e.g.: KEITHLEY 2000	Test the DC accuracy
Insulation pincer clips	Supplied in the accessories	Testing clips
BNC adapter 1	BNC-male-to-female-dual show as Figure 1	Test adapter
BNC adapter 2	BNC-male-to-dual binding post show as Figure 2	Test adapter
BNC adapter 3	BNC-female-to-dual binding post show as Figure3	Test adapter
Load terminal	BNC-male-to 50 Ω load show as Figure 4	Signal source load

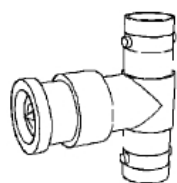

Figure 1 BNC-male-to-female-dual

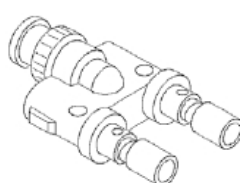

Figure 2 BNC-female-to-dual binding post

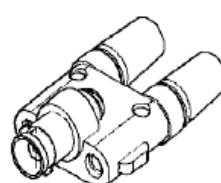

Figure 3 BNC-male-to-dual binding post

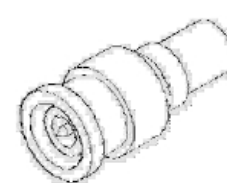

Figure 4 BNC-male-to 50 Ω load

Setup

- 1) Connect power adapter to voltage probe, which turns on green light, to ensure accuracy, test the probe index after 20 minutes.
- 2) Uncover the red black plastic cover of the BNC-male-to-dual binding post.

DC Accuracy

- 1) Connect the probe output to the BNC-female-to-dual binding post; plug the two input terminals of the digital multimeter into the binding post hole.
- 2) Connect the probe input to insulation pincer clips, and then connect the calibrator output and the generator close, connect the red clip to the positive pole, black clip to negative pole.
- 3) Set the probe attenuation factor in the first gear.
- 4) Follow the chart below to set output values for the signal source.
- 5) Enable the signal output, observe and record the output voltage for the attenuation.
- 6) Close the signal source output.
- 7) Switch the probe attenuation factor to the second gear.
- 8) Repeat step 4~6, and calculate whether is within the accuracy ranges.

Model	Attenuation Rate	Signal source output voltage	Probe expected output voltage	Probe practical output voltage
DPB5150(A)	50X	5V	100mV±2mV	
	500X	50V	100mV±2mV	
DPB5700(A)	100X	10V	100mV±2mV	
	1000X	100V	100mV±2mV	

Rise Time

- 1) Configure the fast rise output of the generator for a 50 Ω load. Attach a 50 Ω terminator to the generator fast-rise output and attach the modified BNC adapter to the terminator.
Attach the differential probe input leads (without attachment accessories) by sliding the banana plug of the leads onto the binding posts metal sleeves on the modified BNC adapter.
- 2) Connect the probe output to the oscilloscope, set attenuation factor in the first gear.
- 3) Refer to the below stable to set standard signal generator.
- 4) Enable signal source output and record the rise time.
- 5) Close signal source output.
- 6) Switch the probe attenuation factor to the second gear.
- 7) Repeat step 3-5, and calculate whether is in the range.

Model	Attenuation Rate	Signal source voltage, frequency setting	Expected probe Rise time	Rising time
DPB5150	50X	20Vpp, 70MHz	≤5ns	
	500X	20Vpp, 70MHz	≤5ns	
DPB5150A	50X	20Vpp, 100MHz	≤3.5ns	
	500X	20Vpp, 100MHz	≤3.5ns	
DPB5700	100X	20Vpp, 70MHz	≤5ns	
	1000X	20Vpp, 70MHz	≤5ns	
DPB5700	100X	20Vpp, 100MHz	≤3.5ns	
	1000X	20Vpp, 100MHz	≤3.5ns	

DC Common Mode Rejection Ration(CMRR)

- 1) Set DPB5000 series probes at low attenuation ration, respectively (10X, 50X, 100X).
- 2) Set 500V DC voltage for signal source, now the voltage output shut up.
- 3) Connect the two probe inputs to 500V voltage.
- 4) Connects the probe output to BNC-female- to- dual binding post (as shown in Figure 3), and plug into the two inputs of the digital multimeter.
- 5) Enable signal source output, respectively record voltage output values; check with the following chart to calculate whether is within the ranges.
- 6) Close the calibrator after completion of the test.

Model	Attenuation Rate	Probe expected output voltage	Probe practical output voltage
DPB5150(A)	50X	$\leq 1\text{mV}$	
DPB5700(A)	100X	$\leq 1\text{mV}$	

Note: High voltag 500 V is used during the testing, please pay attention to personal safety; to reduce voltage fluctuation, be sure to make the calibrator output 500 V high voltages after the completion of all connections.

DPB4080 High Voltage Differential Probe

DPB4080 Summary

Model	Maximum Input Voltage	Bandwidth	Attenuation Rate
DPB4080	800V	50MHz	10X/100X

Overview

The DPB4080 differential probe provides a safety means for measuring differential voltage to all models of oscilloscopes. It can convert the high differential voltage ($\leq 800V_{peak}$) into a low voltage ($\leq 8V$) and display on the oscilloscope. Its bandwidth is up to 50MHz, which is ideal for big power testing, development and maintain.

The DPB4080 is designed to operate with the $1M\Omega$ impedance oscilloscopes. When combine with the 50Ω load, the attenuation will be 2 times.

DPB4080 is recommend to use with our own manufactured PL-10 to expand the measuring with the electricity meter to observe more accurate measurement. The accuracy of oscilloscope is 1% and the electricity meter is about 10%)

Electric Specification

- (1) Bandwidth: DC-50MHz
- (2) Attenuation: X100, X10
- (3) Accuracy: +/-1%
- (4) Input voltage range (DC+AC PEAK TO PEAK)
 - $\leq +/-80V$ for x10, (about 30V RMS or DC)
 - $\leq +/-800V$ for x100, (about 290V RMS or DC)
- (5) Permitted max input voltage:
 - Max differential voltage: 800V (DC+AC PEAK TO PEAK)
 - Max voltage between each input terminal and ground: 800V RMS
- (6) Input Impedance:
 - Differential: $54M\Omega / 1.2pF$
 - Between terminal and ground: $27M\Omega / 2.3pF$
- (7) Output voltage: $\leq +/-8V$
- (8) Output impedance: 50Ω
- (9) Rise time: 7ns for x100; 14ns for x10
- (10) Rejection rate on common mode:
 - 60Hz: $> 80dB$; 100Hz: $> 60dB$; 1MHz: $> 50dB$
- (11) Power Supply: Only External 9V DC power supply
- (12) Consumption: 35mA max (0.4 Watt)



Operating environmental conditions

	Reference	Use	Storage
Temperature	+20°C ~ +30°C	0°C ~ +50°C	-30°C ~ +70°C
Relative Humidity	≤70%RH	10%~85%RH	10%~90%RH

(1) Dimensions and weight: 69x26x165mm; 500g

(2) Electrical safety to IEC 1010-1

Dual insulation

Installation category III

Degree of Pollution 2

Related voltage or max line-earth: 6500V RMS

CE: EN50081-1 and 50082-1

Operating procedure

Connect the probe to the oscilloscope with the BP-250 BNC TO BNC cable.

Adjust the vertical zero adjustment of the oscilloscope if necessary.

Select the attenuation ration and the vertical deviation of the oscilloscope in accordance with the conversion table below.

Note: The power must be on

Attenuation Rate	X100	X10
Input Voltage (DC+AC Peak)	±800V	±80V

Attention: The real vertical deviation is equal to the attenuation ration multiplied by the range of vertical deviation selected on the oscilloscope. It will be double in the case of a 50Ω load.

Care and Maintenance

- 1) Keep the probe clean and dry.
- 2) Please wipe with soft dry cloth when clean needed, must not use chemicals to clean.
- 3) Please put the probe in the package provided, and put it in cool, clean and dry places.
- 4) Please put the probe in the package provided to prevent shock.
- 5) Do not forcefully pull the input and output lead to prevent bending, twisted and folding.

Contact SIGLENT

SIGLENT TECHNOLOGIES CO., LTD

Address: 3/F, Building 4, Antongda Industrial Zone, Liuxian Road,
68 District, Baoan District, Shenzhen, P.R. CHINA

Service Tel: 0086 755 3661-5186

Post Code: 518101

E-mail: sales@siglent.com

<http://www.siglent.com>