



# DS70000 Series

## High-End Digital Oscilloscope

Quick Guide

Apr. 2021



## **Guaranty and Declaration**

### **Copyright**

© 2021 RIGOL TECHNOLOGIES CO., LTD. All Rights Reserved.

### **Trademark Information**

RIGOL® is the trademark of RIGOL TECHNOLOGIES CO., LTD.

### **Notices**

- RIGOL products are covered by P.R.C. and foreign patents, issued and pending.
- RIGOL reserves the right to modify or change parts of or all the specifications and pricing policies at the company's sole decision.
- Information in this publication replaces all previously released materials.
- Information in this publication is subject to change without notice.
- RIGOL shall not be liable for either incidental or consequential losses in connection with the furnishing, use, or performance of this manual, as well as any information contained.
- Any part of this document is forbidden to be copied, photocopied, or rearranged without prior written approval of RIGOL.

### **Product Certification**

RIGOL guarantees that this product conforms to the national and industrial standards in China as well as the ISO9001:2015 standard and the ISO14001:2015 standard. Other international standard conformance certifications are in progress.

### **Contact Us**

If you have any problem or requirement when using our products or this manual, please contact RIGOL.

E-mail: [service@rigol.com](mailto:service@rigol.com)

Website: <http://www.rigol.com>

# 1 Safety Requirement

## 1.1 General Safety Summary

Please review the following safety precautions carefully before putting the instrument into operation so as to avoid any personal injury or damage to the instrument and any product connected to it. To prevent potential hazards, please follow the instructions specified in this manual to use the instrument properly.

- |   |  |    |  |
|---|--|----|--|
| 1 | Only the exclusive power cord designed for the instrument and authorized for use within the destination country could be used. | 9  | Do not operate the instrument with suspected failures. |
| 2 | Ensure that the instrument is safely grounded.   | 10 | Provide adequate ventilation.                          |
| 3 | Observe all terminal ratings.  | 11 | Do not operate in wet conditions.                      |
| 4 | Use proper overvoltage protection.   | 12 | Do not operate in an explosive atmosphere.             |
| 5 | Do not operate without covers.   | 13 | Keep instrument surfaces clean and dry.                |
| 6 | Do not insert objects into the air outlet.   | 14 | Prevent electrostatic impact.                          |
| 7 | Use the proper fuse.   | 15 | Handle with caution.                                   |
| 8 | Avoid circuit or wire exposure.  |    |  |

## 1.2 Safety Notices and Symbols

### Safety Notices in this Manual:



#### Warning

Indicates a potentially hazardous situation or practice which, if not avoided, will result in serious injury or death.



#### Caution

Indicates a potentially hazardous situation or practice which, if not avoided, could result in damage to the product or loss of important data.

### Safety Terms on the Product:

- **DANGER**

It calls attention to an operation, if not correctly performed, could result in injury or hazard immediately.

- **WARNING**

It calls attention to an operation, if not correctly performed, could result in potential injury or hazard.

- **CAUTION**

It calls attention to an operation, if not correctly performed, could result in damage to the product or other devices connected to the product.

**Safety Symbols on the Product:**



**Hazardous Voltage**



**Safety Warning**



**Protective Earth Terminal**

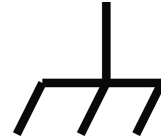

**Chassis Ground**

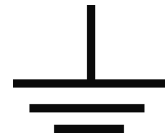

**Test Ground**

## 1.3 Care and Cleaning

### Care

Do not store or leave the instrument where it may be exposed to direct sunlight for long periods of time.

### Cleaning

Clean the instrument regularly according to its operating conditions.

- 1 Disconnect the instrument from all power sources.
- 2 Clean the external surfaces of the instrument with a soft cloth dampened with mild detergent or water. Avoid having any water or other objects into the chassis via the heat dissipation hole. When cleaning the LCD, take care to avoid scarifying it.



### Caution

**To avoid damage to the instrument, do not expose it to caustic liquids.**



### Warning

**To avoid short-circuit resulting from moisture or personal injuries, ensure that the instrument is completely dry before connecting it to the power supply.**

## 2 Document Overview

This manual gives you a quick review about the front and rear panel of DS70000 series, the user interface, and the basic operation method.



### Tip

For the latest version of this manual, download it from the official website of **RIGOL** (<http://www.rigol.com>).

### Publication Number

QGA28100-1110

### Format Conventions in this Manual

#### 1 Key

The front panel key is denoted by the menu key icon. For example,  indicates the "Default" key.

#### 2 Menu

The menu softkey is denoted by the format of "Menu Name (Bold) + Character Shading" in the manual. For example, **Setup**.

#### 3 Operation Procedures

The next step of the operation is denoted by ">" in the manual. For example, .

> **Storage** indicates that first clicking or tapping the icon , then clicking or tapping **Storage**.

### Content Conventions in this Manual

DS70000 series includes the following models. Unless otherwise specified, this manual takes DS70504 as an example to introduce DS70000 series and its basic operations.

Model	Max. Analog Bandwidth	No. of Analog Channels
DS70504	5 GHz	4
DS70304	3 GHz	4

## 3 General Inspection

---

### 1 Inspect the packaging

If the packaging has been damaged, do not dispose the damaged packaging or cushioning materials until the shipment has been checked for completeness and has passed both electrical and mechanical tests.

The consigner or carrier shall be liable for the damage to the instrument resulting from shipment. **RIGOL** would not be responsible for free maintenance/rework or replacement of the instrument.

### 2 Inspect the instrument

In case of any mechanical damage, missing parts, or failure in passing the electrical and mechanical tests, contact your **RIGOL** sales representative.

### 3 Check the accessories

Please check the accessories according to the packing lists. If the accessories are damaged or incomplete, please contact your **RIGOL** sales representative.

## 4 Product Overview

DS70000 series is RIGOL's 7th generation of the digital oscilloscope. It adopts RIGOL's chipset "Phoenix", delivering excellent performance with a maximum sample rate of 20 GSa/s, 5 GHz real-time bandwidth. In addition to the improvement of hardware specification, DS70000 series also has many user-friendly designs to ensure high-quality user experience.

### 4.1 Front Panel Overview

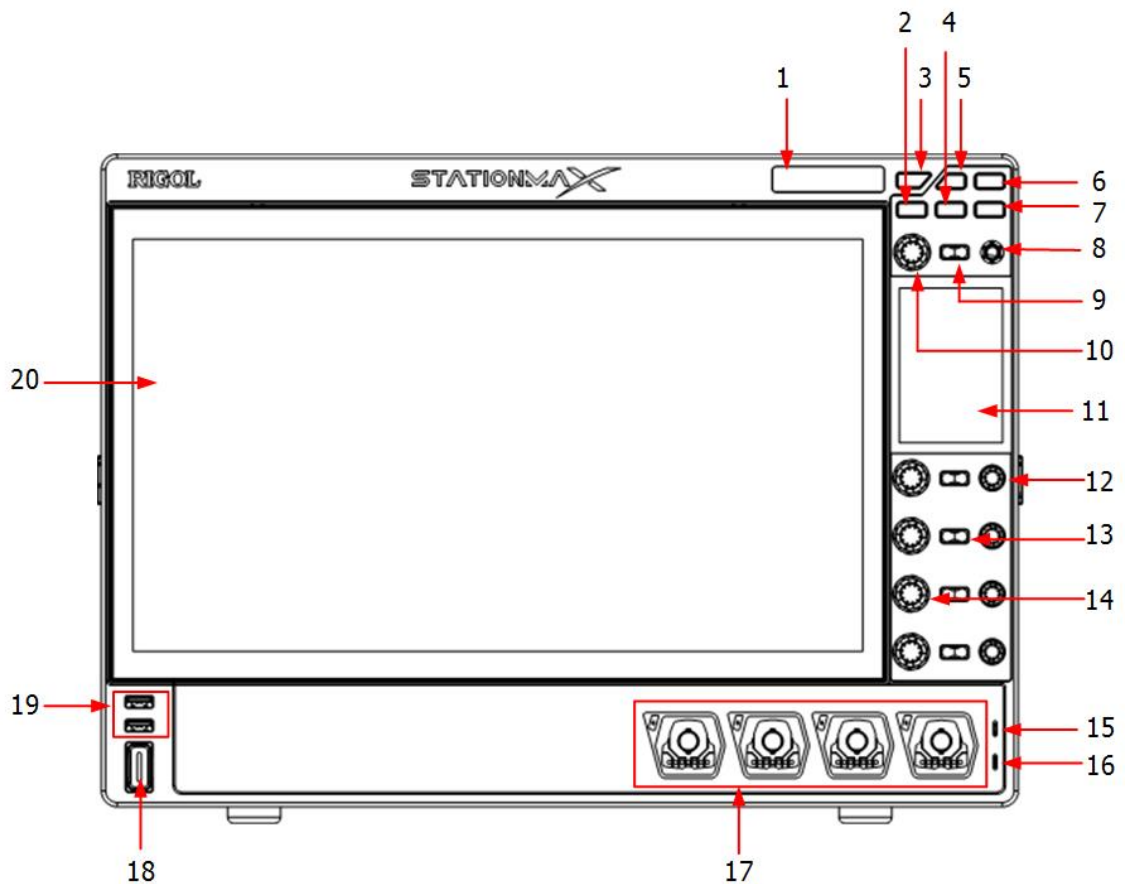
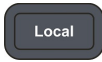
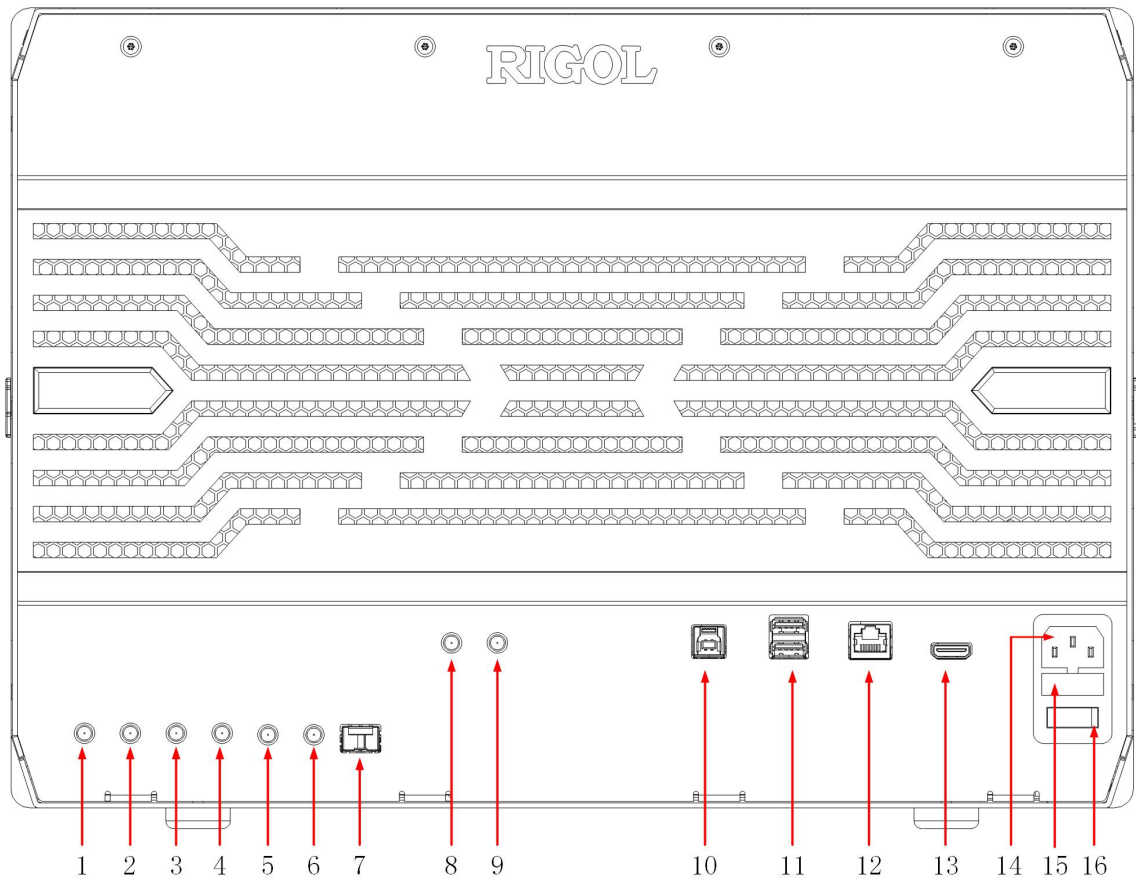

Figure 4.1 Front Panel

1	Electronic Label	11	High-Definition Smart and Quick-responsive Keyboard
2	Screen Inclination Adjustment Key	12	Channel Vertical Position Knob
3	Run/Stop Key	13	Channel On/Off Key
4	Default Key	14	Channel Vertical Scale Knob
5	Working Mode Switchover Key	15	Probe Compensation Signal Output Terminal

6	Quick Operation Key (related to quick operation setting)	16	Probe Compensation Signal Ground Terminal
7	 Key	17	Analog Channel Input Terminals
8	Multi-function Knob 1	18	Power Key
9	Multi-function Key	19	USB HOST Interface
10	Multi-function Knob 2	20	Inclination Electronically Adjustable High-Definition Large Touch Screen

## 4.2 Rear Panel Overview



**Figure 4.2 Rear Panel**

1	Pulse Source Input (temporarily unavailable)	9	10 MHz IN Reference Clock Input
2	Pulse Source Output (temporarily unavailable)	10	USB DEVICE Interface
3	Pulse Source Reverse Output (temporarily unavailable)	11	USB HOST Interface
4	Pulse Source Reverse Input (temporarily unavailable)	12	LAN Interface



5	AUX OUT Trigger Output	13	HDMI Video Output
6	EXT (1MΩ/18pF) Trigger Input Terminal	14	AC Power Cord Connector
7	SFP+ Interface (10 Gbps)	15	Fuse
8	10 MHz OUT Reference Clock Output	16	Power Switch

### 4.3 User Interface

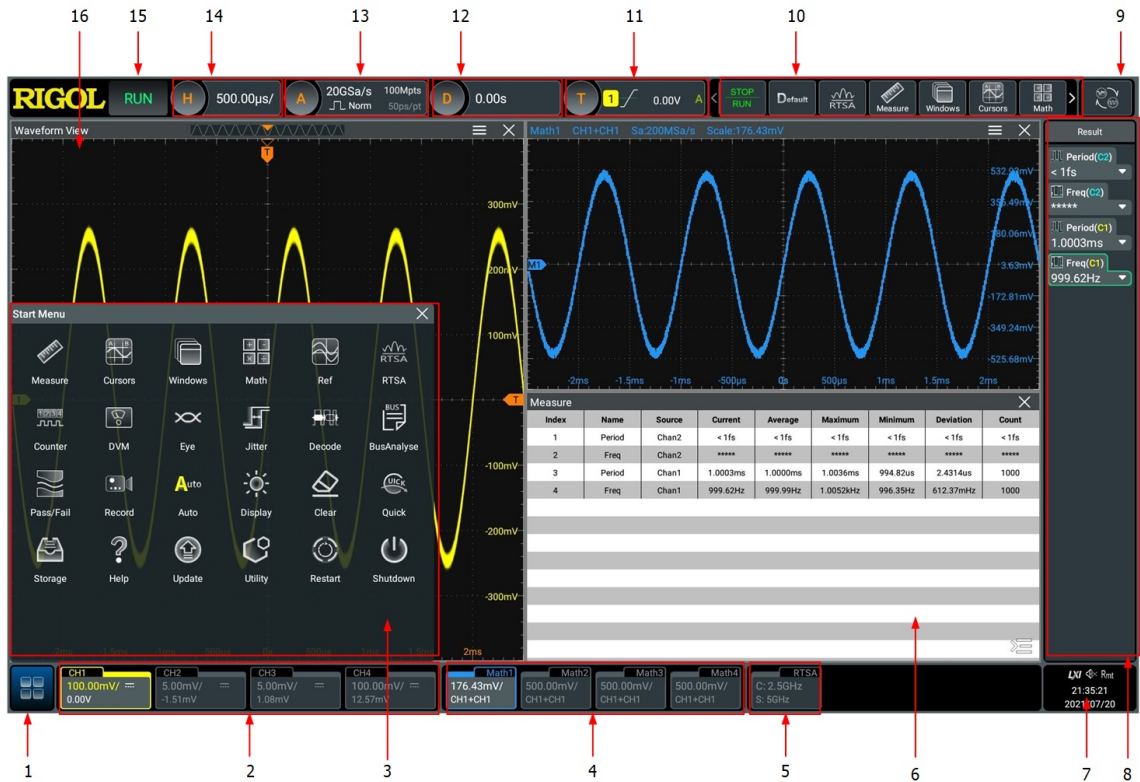

Figure 4.3 User Interface

1	Function Navigation Icon	9	Mode Switchover Icon
2	Channel Label	10	Function Icon Bar
3	Function Navigation Menu	11	Trigger Label
4	Channel Operation Label	12	Horizontal Position Label
5	RTSA Label	13	Sample Rate and Memory Depth Label
6	Multi-window Display Area	14	Horizontal Time Base Label
7	Notification Area	15	Operating Status
8	Result Display Window	16	Waveform Display Area

## 5 To Prepare for Use

### 5.1 To Connect to AC Power

The power requirements of the oscilloscope are 100-240 V, 45-440 Hz. Please use the power cord provided in the accessories to connect the oscilloscope to the AC power source, as shown in *Figure 5.1*.

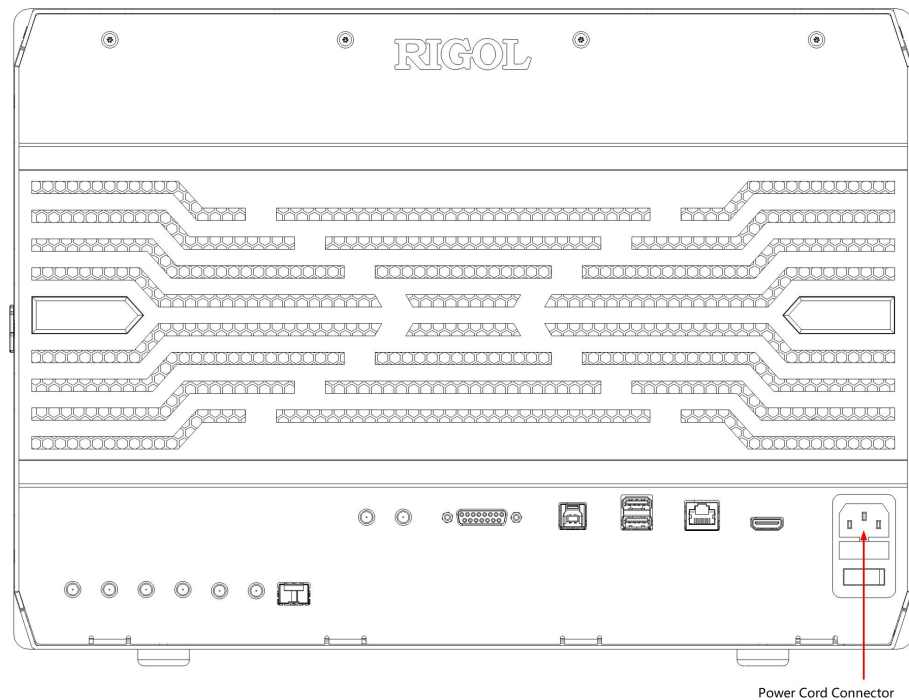



Figure 5.1 To Connect to AC Power



#### Warning



To avoid electric shock, ensure that the instrument is correctly grounded.

### 5.2 Turn-on Checkout

After the instrument is connected to the power source, press the power key  at the lower-left corner of the front panel to power on the instrument. During the start-up process, the instrument performs a series of self-tests. After the self-test, the splash screen is displayed.



### Note

- **Restart:** Click or tap the function navigation icon  at the lower-left corner of the screen to open the function navigation. Click or tap the **Restart** icon, then a prompt message “Are you sure to reboot?” is displayed. Click or tap **OK** to restart the instrument.
- **Shutdown:** Click or tap the function navigation icon  at the lower-left corner of the screen to open the function navigation. Click or tap the **Shutdown** icon, then a prompt message “Are you sure to shutdown?” is displayed. Click or tap **OK** to shut down the instrument.

## 5.3 To Set the System Language

This oscilloscope supports multiple languages. You can click or tap  > **Utility** > **Setup** > **Language** to set the system language.

## 5.4 To Connect the Probe

RIGOL provides passive and active probes for DS70000 series. For specific probe models, please refer to *DS70000 Datasheet*. For detailed technical information of the probes, please refer to the corresponding Probe User Guide.

### To Connect the Passive Probe

- 1 Connect the BNC terminal of the probe to an analog channel input terminal of the oscilloscope on the front panel as shown in *Figure 5.2*.
- 2 Connect the ground alligator clip or spring of the probe to the circuit ground terminal, and then connect the probe tip to the circuit point to be tested.

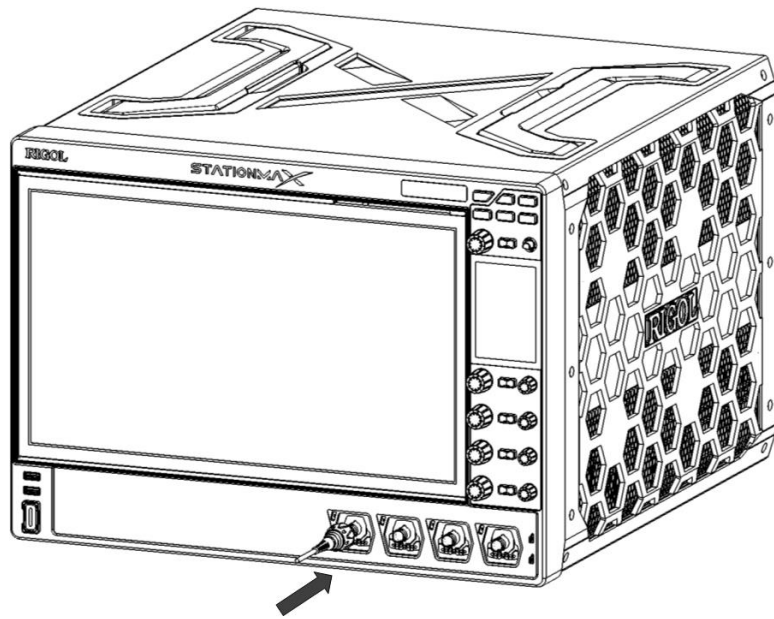

**Figure 5.2 To Connect the Passive Probe**

After you connect the passive probe, check the probe function and probe compensation adjustment before making measurements. For detailed procedures, refer to "*Function Inspection*" and "*Probe Compensation*".

#### **To Connect the Active Probe**

Take PVA8000 (active differential probe) as an example.

- 1 Connect the probe head to the preamp of the active probe, as shown in the figure below.

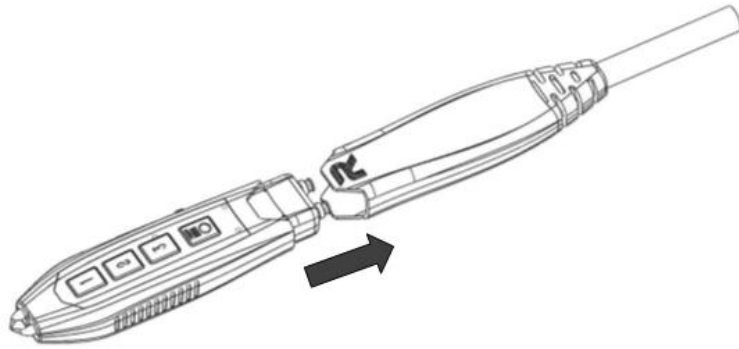

**Figure 5.3 To Connect the Probe Head to the PA of the Active Probe**

- 2 Connect the other end of the preamp to an analog channel input terminal of the oscilloscope on the front panel, as shown in the figure below. Note that you need to push the probe to the due position to lock it firmly.

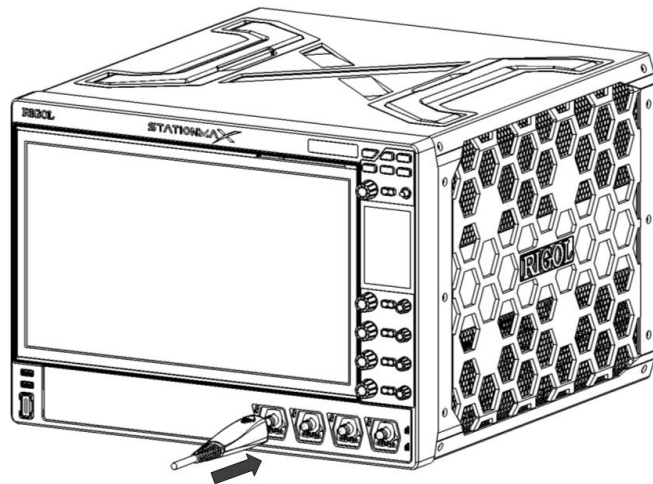

**Figure 5.4 To Connect the Active Probe**

- 3 Use the probe's auxiliary device to connect the probe head to the circuit under test. For detailed information of the probes, please refer to *User Guide for PVA8000 Series Active Probe*.

After connecting the active probe, you can perform probe calibration and offset voltage adjustment if necessary. For detailed procedures, refer to the "Active Probe" section in User Guide.

## 5.5 Function Inspection

- 1 Press  on the front panel, then a prompt message displaying "Restore default settings?" appears on the screen. Click **OK** to restore the instrument to its factory default settings.
- 2 Connect the ground alligator clip of the probe to the "Ground Terminal" as shown in *Figure 5.5* below.
- 3 Use the probe to connect the input terminal of CH1 of the oscilloscope and the "Compensation Signal Output Terminal" of the probe, as shown in *Figure 5.5*.

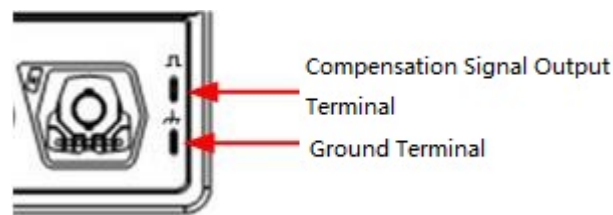

**Figure 5.5 To Use the Compensation Signal**

- 4 Set the probe attenuation to 10X, and then click  > **Auto**.
- 5 Observe the waveform on the display. In normal condition, the square waveform as shown in the figure below should be displayed.

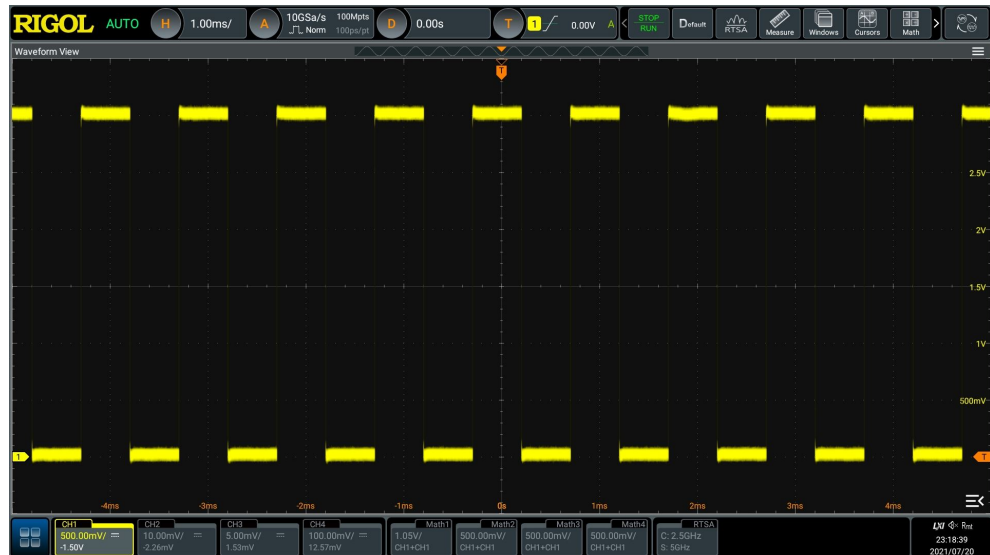

Figure 5.6 Waveform Signal

- Use the same method to test the other channels. If the square waveforms actually shown do not match that in the figure above, please perform "**Probe Compensation**" introduced in the next section.



### Warning

To avoid electric shock when using the probe, please make sure that the insulated wire of the probe is in good condition. Do not touch the metallic part of the probe when the probe is connected to high voltage source.

## 5.6 Probe Compensation

When the probes are used for the first time, you should compensate the probes to make them match the input channels of the oscilloscope. Non-compensated or poorly compensated probes may cause measurement inaccuracy or errors. The probe compensation procedures are as follows:

- Perform Step 1, 2, 3 and 4 specified in "*Function Inspection*".
- Check the displayed waveforms and compare them with the waveforms shown in *Figure 5.7*.

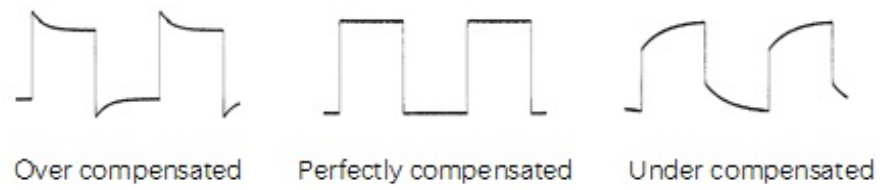

**Figure 5.7 Probe Compensation**

- 3 Use the probe compensation adjustment tool provided in the accessories to adjust the low-frequency compensation adjustment hole on the probe until the displayed waveform is consistent with the "Perfectly compensated" waveform shown in the above figure.



## 6 Touch Screen Gestures

---

The instrument provides a super large capacitive touch screen, which is convenient for users to operate and make configurations. It has strong waveform display capability and excellent user experience. It features great convenience, high flexibility, and great sensitivity. The actions supported by the touch screen controls include tapping, pinching&stretching, as well as dragging.

### 6.1 Tap

---

Use one finger to tap the symbol or characters on the screen slightly, as shown in *Figure 6.1*. With the Tap gesture, you can perform the following operation:

- Tap the menu displayed on the screen to operate on the menu.
- Tap the function navigation icon  at the lower-left corner of the touch screen to enable the function navigation.
- Tap the displayed numeric keypad to set the parameters.
- Tap the virtual keypad to set the label name and the filename.
- Tap the close window icon at the upper-right corner of the prompt message box to close it.
- Tap the other windows displayed on the screen to operate on the window.



**Figure 6.1 Tap Gesture**

### 6.2 Drag

---

Use one finger to select the object, and then drag the object to a destination place, as shown in *Figure 6.2*. With the drag gesture, you can perform the following operation:

- Drag the waveform to change its position or scale.
- Drag the window controls to change the position of the window (e.g. numeric keypad).
- Drag the cursor to change the position of the cursor.
- In multi-window display, drag one of the displayed windows to change its position on the screen.

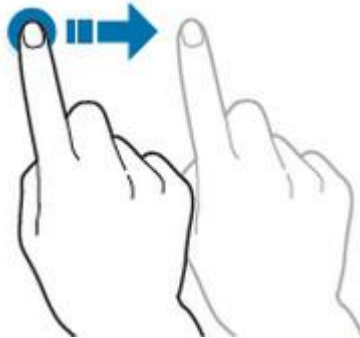

Figure 6.2 Drag Gesture

## 6.3 Pinch&Stretch

Pinch or stretch two points on the screen with two fingers to zoom in or out the waveform. To zoom in the waveform, first pinch the two fingers and then stretch the fingers; to zoom out the waveform, first stretch the two fingers, and then pinch the fingers together, as shown in the figure below. With the pinch&stretch gesture, you can perform the following operation:

- Pinching&stretching in the horizontal direction can adjust the horizontal time base of the waveform.
- Pinching&stretching in the vertical direction can adjust the vertical scale of the waveform.



**Figure 6.3 Pinch&Stretch Gesture**

## 7 To Use the Built-in Help System

The help system of this oscilloscope provides instructions for all the function keys on the front panel and their corresponding menu keys. Click or tap  > **Help** to enter the help system.

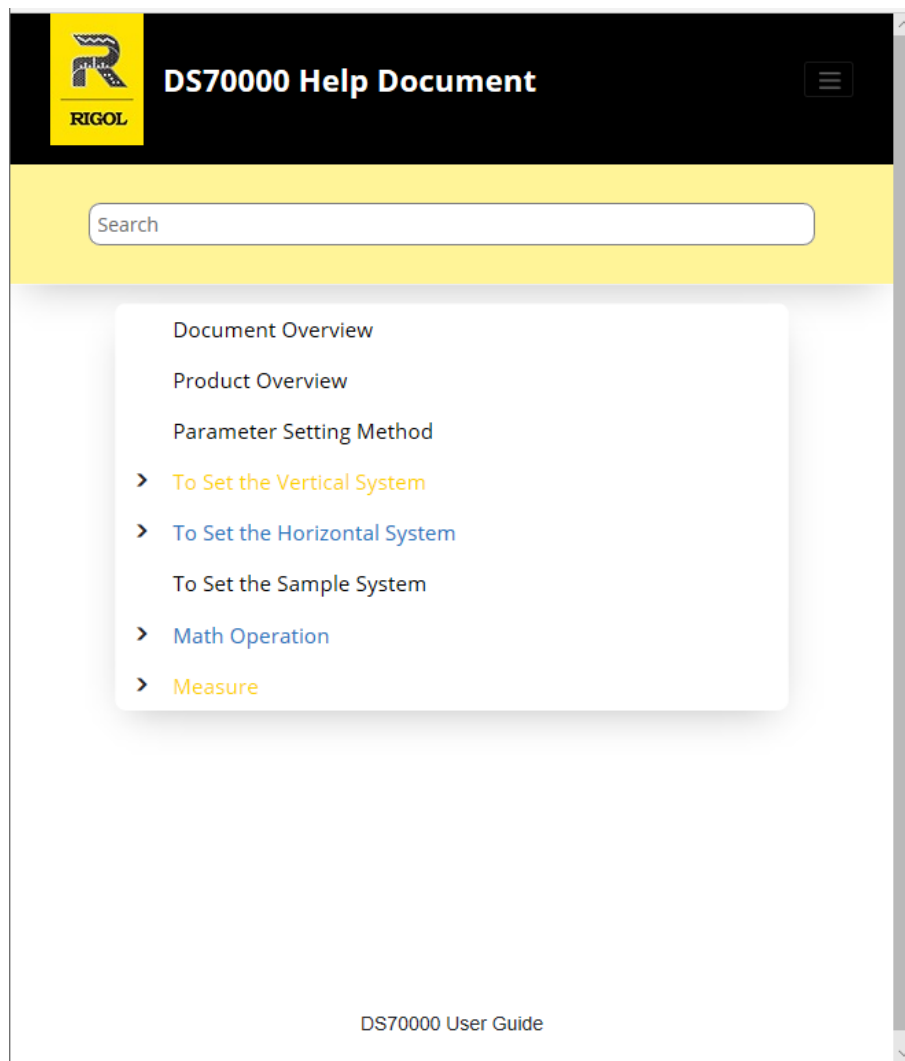

**Figure 7.1 Help Information**

After opening the help interface, you can get its help information by clicking on or tapping the link for the desired item.

## 8 Parameter Setting Method

For this instrument, you can use the knob and touch screen operation to set parameters. The common parameter setting methods are as follows:

- **Method 1:** Some parameters can be adjusted by rotating the knob on the front panel.
- **Method 2:** Click or tap the input field of a specified parameter, then a virtual keypad is displayed. Complete the parameter setting with the keypad.

### Input a Value

When setting or modifying a parameter, input an appropriate value with the keypad in [Figure 8.1](#).

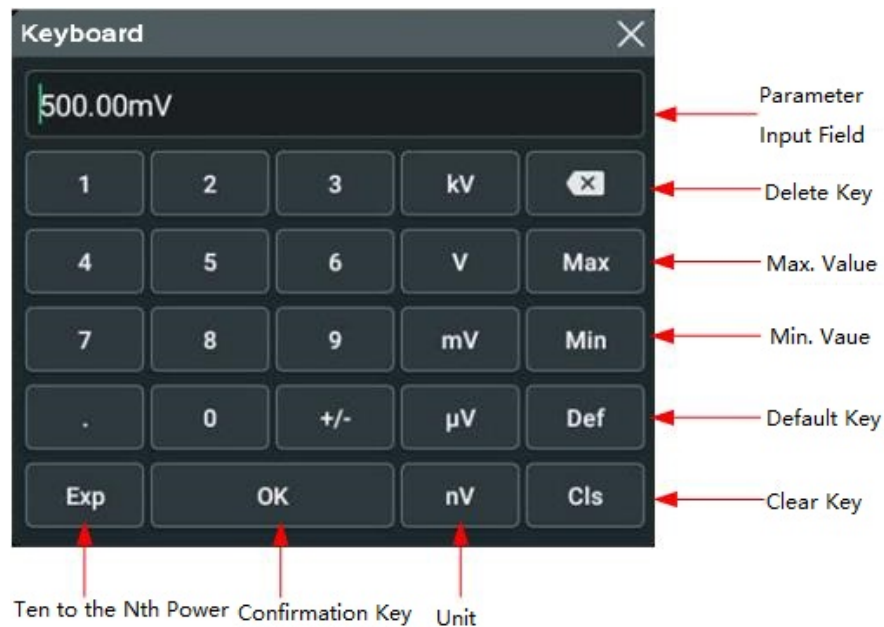

**Figure 8.1 Numeric Keypad**

Click or tap the value or unit in the numeric keypad to complete the input. After you input all the values and select the desired units, the numeric keypad is turned off automatically. This indicates that you have completed parameter setting. Besides, after you have input the values, you also also press "OK " directly to close the numeric keypad. At this time, the unit of the parameter is the default unit. In the numeric keypad, you can perform the following operation:

- Deletes the parameter value that has been input;
- Sets the parameter value to a maximum or minimum value;
- Sets the parameter to a default value;

- Clears the parameter value.

## 9 Fuse Replacement

If you need to replace the fuse, use only the specified fuse (AC 250V, T3.15A; 5.2 mm×20 mm) and perform the following operations (as shown in *Figure 9.1*):

- 1 Turn off the instrument, cut off the power, and remove the power cord.
- 2 Use a small straight slotted screwdriver to pry out the fuse holder.
- 3 Take out the fuse holder.
- 4 Replace the old fuse with a specified fuse.
- 5 Install the fuse holder.

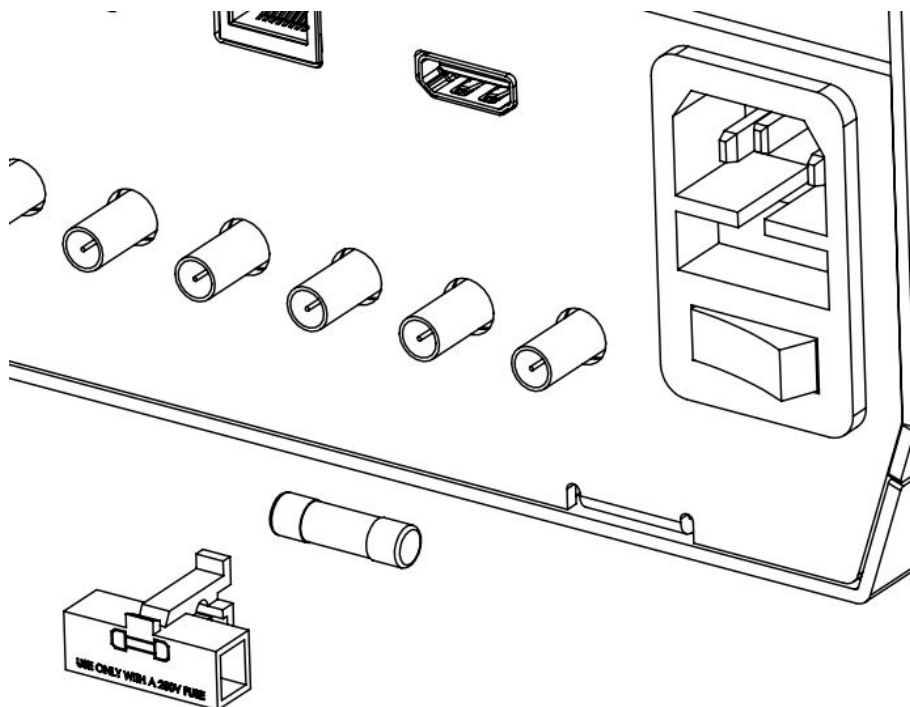

Figure 9.1 Fuse Replacement



### Warning

To avoid electric shock, please ensure that the instrument has been turned off, the power source has been cut off, and the fuse to be used conforms to the fuse rating.

## 10 Remote Control

The instrument can be remotely controlled by the following three methods:

- **User-defined Programming**

Users can program and control the instrument by using the SCPI (Standard Commands for Programmable Instruments) commands. For details about the SCPI commands and programming, refer to *Programming Guide*.

- **PC Software**

Users can use the PC software to send commands to control the instrument remotely. RIGOL Ultra Sigma is recommended. You can download the software from RIGOL official website (<http://www.rigol.com>).

**Operation Procedures:**

- Set up communication between the instrument and PC.
- Run Ultra Sigma and search for the instrument resource.
- Open the remote command control panel to send commands.

- **Web Control**

This instrument supports Web Control. Connect the instrument to the network, then input the IP address of the instrument into the address bar of the browser of your computer. The web control interface is displayed. Click Web Control to enter the web control page. Then you can view the display of the real-time interface of the instrument. Through the Web Control method, you can migrate the device control to the control terminals (e.g. PC, Mobile, iPad, and other smart terminals) to realize remote control of the instrument. When you first log in to the Web Control, the user name is "admin" and password is "rigol".

This instrument can be connected to the PC via the USB, LAN, or GPIB interface to set up communication and realize remote control through the PC. The remote control can be realized by using SCPI (Standard Commands for Programmable Instruments) commands.

This chapter will illustrate how to use the to work with RIGOL Ultra Sigma software to remotely control the instrument via various interfaces. Note: When communicating with the PC via GPIB, the instrument does not support large data transmission operation such as screen shot and waveform reading.



**Tip**

Before setting up communication, please turn off the instrument to avoid causing damage to the communication interfaces.



# 11 More Product Information

---

## 1 Obtain the Device Information

Click or tap  > **Utility** > **About** to obtain the information of the instrument, such as the model, serial number, firmware version number, and hardware version number.

## 2 View the Option Information and Install the Option

The instrument is installed with the trial versions of the options before leaving factory. The trial time starts from the time when you power on the instrument for the first time, and the trial time is about 2,160 minutes. Open the "**Utility**" menu, and then click or tap **Option list** to view the options currently installed on the oscilloscope and their information. For details about the option installation, refer to descriptions in User Guide.

For more information about this instrument, refer to the relevant manuals by logging in to the official website of RIGOL (<http://www.rigol.com>) to download them.

- *DS70000 User Guide*: introduces the functions of the instrument and the operation methods, remote control methods, possible failures and solutions in using the instrument, specifications, and order information.
- *DS70000 Programming Guide*: provides detailed descriptions of SCPI commands and programming examples of the instrument.
- *DS70000 Datasheet*: provides the main features and technical specifications of the instrument.

#### **HEADQUARTER**

**RIGOL TECHNOLOGIES CO., LTD.**  
No.8 Keling Road, New District,Suzhou,  
JiangSu,P.R.China  
Tel:+86-400620002  
Email:info@rigol.com

#### **EUROPE**

**RIGOL TECHNOLOGIES EU GmbH**  
Carl-Benz-Str. 11  
82205 Gilching  
Germany  
Tel: +49 (0)8105 - 27292-0  
Email: info-europe@rigol.com

#### **NORTH AMERICA**

**RIGOL TECHNOLOGIES, USA INC.**  
8140 SW Nimbus Ave.  
Beaverton, OR 97008  
Tel: +1-877-4-**RIGOL**-1  
Fax: +1-877-4-**RIGOL**-1  
Email: info@rigol.com

#### **JAPAN**

**RIGOL TECHNOLOGIES JAPAN, LLC**  
501, LATORRETTA, 2-37-1, Numabukuro,  
Nakano-Ku, Tokyo, Japan  
Tel: +81-3-6262-8932  
Fax: +81-3-6262-8933  
Email: info-japan@rigol.com

---

**RIGOL**® is the trademark of **RIGOL TECHNOLOGIES CO., LTD.** Product information in this document subject to update without notice. For the latest information about **RIGOL**'s products, applications and services, please contact local **RIGOL** channel partners or access **RIGOL** official website: [www.rigol.com](http://www.rigol.com)