

User Manual for DTS-6560KN



Appendix

Content

Revision History	3
Recommended Use	4
1. Package Contents	5
2. Product Configuration	6
3. Interface Description.....	7
4. OSD Control Board Description	8
5. Remote Control.....	15
6. Trouble shooting	16
7. Specification	18

Recommended Use

FOR OPTIMUM PERFORMANCE, PLEASE NOTE THE FOLLOWING WHEN SETTING UP AND USING THE TOUCH SCREEN MONITOR.

- **DO NOT OPEN THE MONITOR.**
Opening or removing covers may expose you to dangerous shock hazards or other risks.
Once you open it the warranty voids.
- To protect from electrical shock, unplug the display power supply from the wall before moving.
- Do not put anything on top of the monitor.
- Do not spill any liquids into the cabinet or use your monitor near water.
- Do not place this product on a sloping or unstable cart, stand or table, as the monitor may fall, causing serious damage to the monitor.
- If you connect or disconnect the HDMI cable while both of PC's and LCD monitor's power is turned on, the monitor might show some garbage on the screen or could be damaged. Please turn off the TFT-LCD monitor's power before connect or disconnect HDMI cable.
- Ensure that sufficient space is available around the display to provide air circulation for cooling.
- Ensure that ambient air temperature will not exceed the specified maximum temperature.
- Handle with care when transporting. Save packaging for transporting.
- Do not touch or press the surface of on the LCD panel, it will cause a permanent damage. Use only soft cloth with non-ammonia glass cleaner to clean the panel.

Thank you for your selection of 4K Touch Screen Display Monitor

Please take a few minutes to read this User's manual for the best performance of this monitor.

Information in this manual is subject to change without prior notice for improving design, function and etc.

1. Package Contents

Your LCD monitor package will consist of the primary components listed below.



Touch USB Cable



HMDI Cable



Power Cord

** It's possible that it can vary from country*

Note) Actual accessories may differ from those in this user's guide.

2. Product Configuration

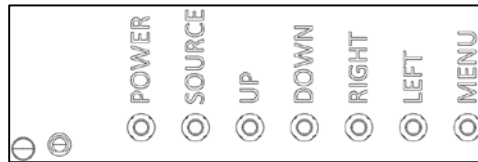
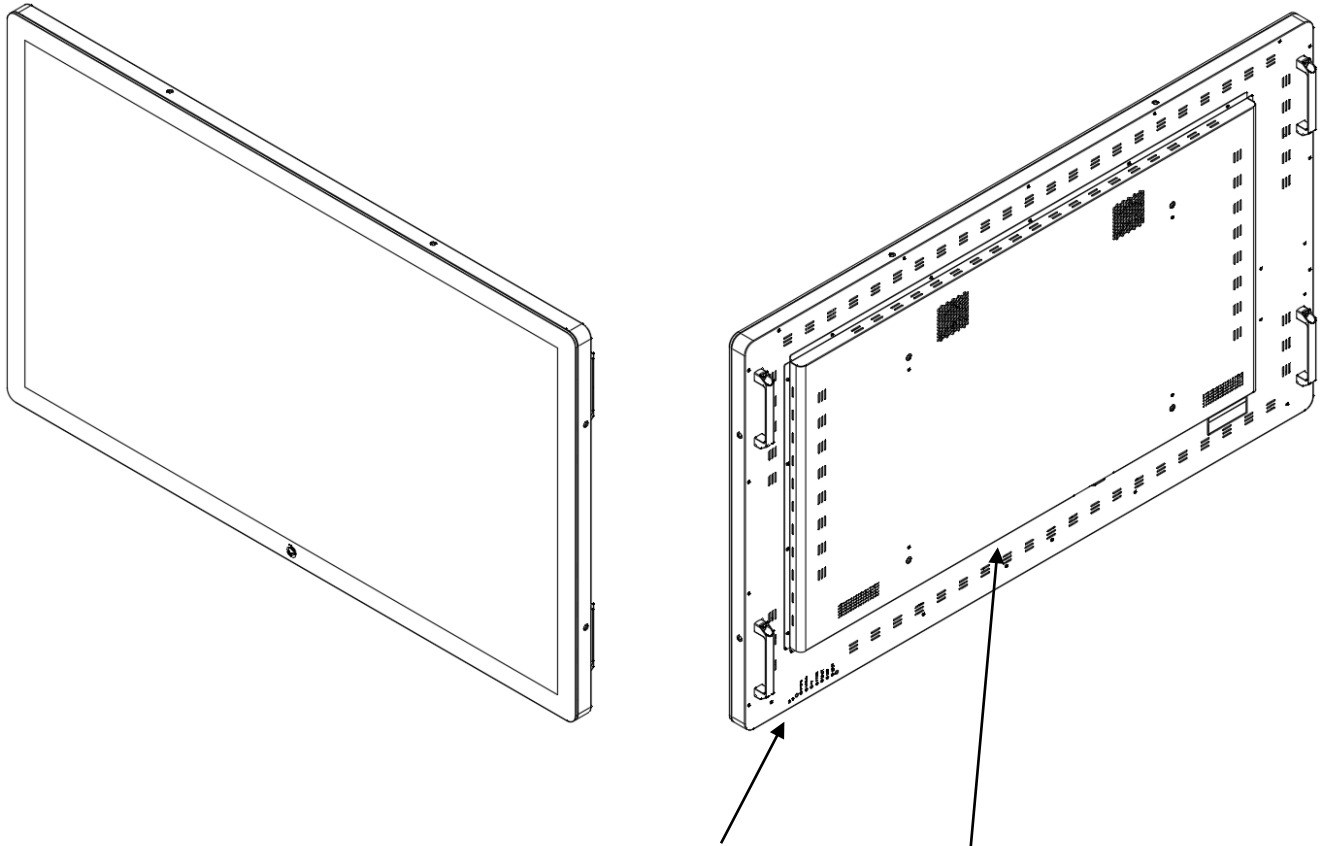

OSD Button (Attached page 8)

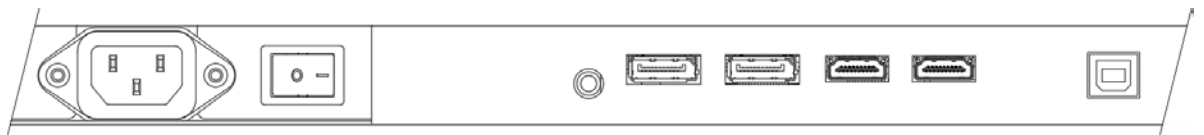

Interface Terminal (Attached page 7)

Note) Actual Touch Screen Monitor may differ from those in this user's drawing

3. Interface Description

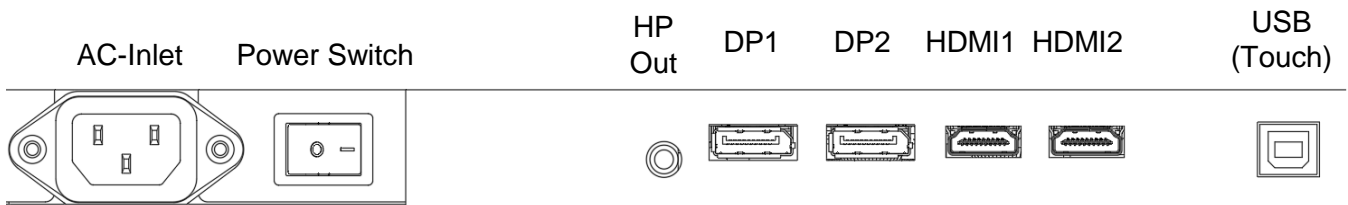

No	Name	Description
1	AC-Inlet	<ul style="list-style-type: none"> AC input terminal : 100V~240V (50hz~60hz)
2	Power Switch	<ul style="list-style-type: none"> Power On/Off Switch
3	HP Out	<ul style="list-style-type: none"> For Headphone Output
4	DP1	<ul style="list-style-type: none"> For DP Input 1 Connector to the digital video and audio input terminal
5	DP2	<ul style="list-style-type: none"> For DP Input 2 Connector to the digital video and audio input terminal
6	HDMI1	<ul style="list-style-type: none"> For HDMI(2.0) Input 1 Connector to the digital video and audio input terminal
7	HDMI2	<ul style="list-style-type: none"> For HDMI(2.0) Input 2 Connector to the digital video and audio input terminal
8	USB(Touch)	<ul style="list-style-type: none"> Touch screen connect USB cable. Connect to PC's USB 2.0 port

4. OSD Control Board Description

4.1 OSD Interface Description

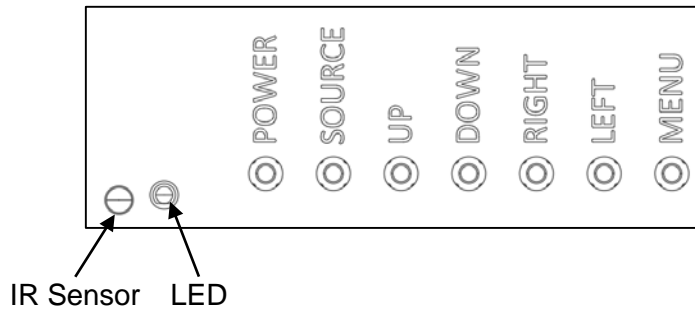

No	Name	Description
1	IR Sensor	<ul style="list-style-type: none"> • IR Sensor for remote control
2	LED	<ul style="list-style-type: none"> • Indicated LED <ul style="list-style-type: none"> - . Red Color : Display Power On - . Green Color : Display On - . Yellow Color : Display Error
3	POWER BUTTON	<ul style="list-style-type: none"> • Display Power On / Off
4	SOURCE BUTTON	<ul style="list-style-type: none"> • Selected to Input video source : Hot key <ul style="list-style-type: none"> - . Auto Select , HDMI (1~4) and DP
5	UP BUTTON (▲)	<ul style="list-style-type: none"> • Check current input signal : Hot key • Exit the present menu • Up shift
6	DOWN BUTTON (▼)	<ul style="list-style-type: none"> • Display Option Function : Hot key <ul style="list-style-type: none"> - . Screen split : 1,2 and 4 screen - . Screen rotation - .Audio source • Choose the present menu • Down shift
7	RIGHT BUTTON (▶)	<ul style="list-style-type: none"> • Sound mute & Increases Volume level : Hot key • Increase level • Right shift
8	LEFT BUTTON (◀)	<ul style="list-style-type: none"> • Decreases Volume level : Hot key • Increase level • Left shift
9	MENU BUTTON	<ul style="list-style-type: none"> • Display the setting menu • Choose or cancel the present menu

4.2 OSD Setting

- Press “MENU” button to display the main menu
- Press “MENU” button again choose to the present menu or Press “ UP” (▲) button to exit the present menu.
- Press ◀/▶ button to select item, (Picture, Color, Advance, Input, Other, Information)
- Select correspond item, press “DOWN”(▼) button.

Picture Mode

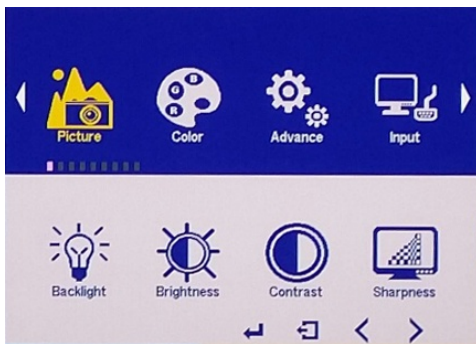

Color Mode

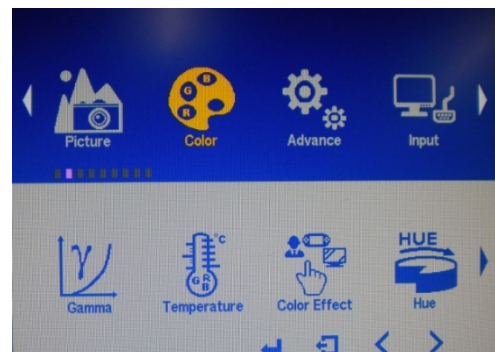

Advance Mode

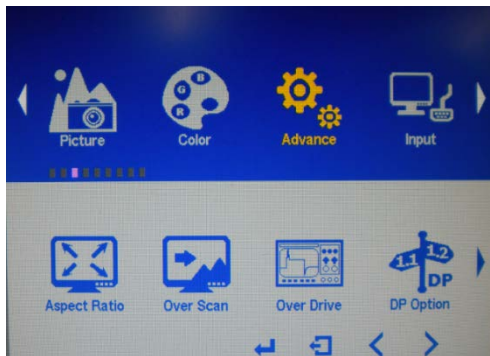

Input Mode

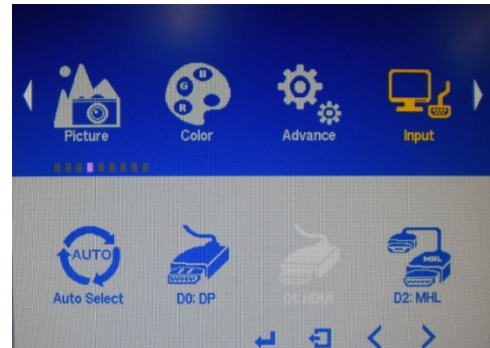

Other

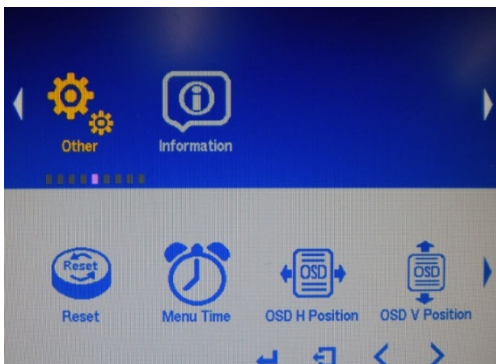

Information

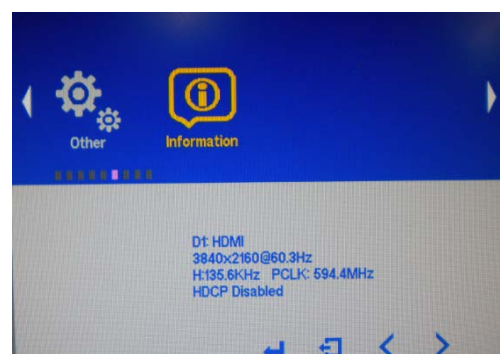

[Picture Mode]

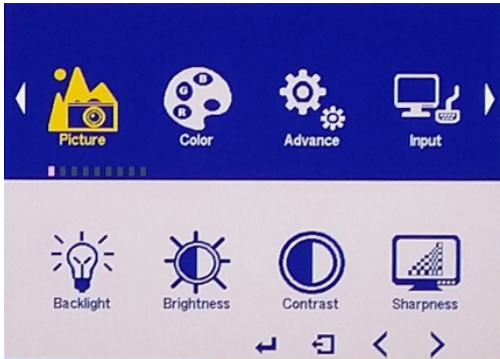

- Press ◀/▶ button to select picture mode. (Backlight, Brightness, Contrast, Sharpness)
- Select correspond item, press “DOWN”(▼) button or ◀/▶ button to enter in the submenu
- Press “ UP” (▲) button to return to the previous menu or exit the present menu.

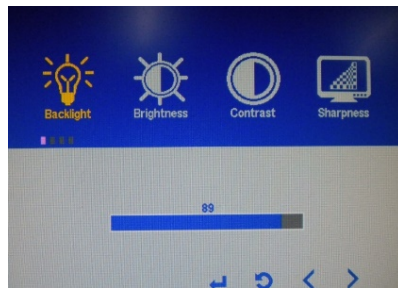
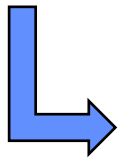

- Backlight

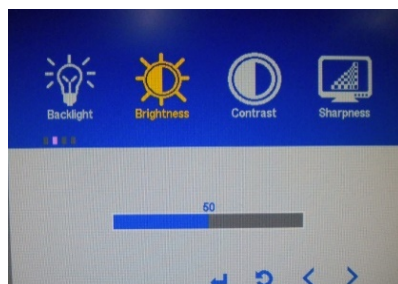

- Brightness

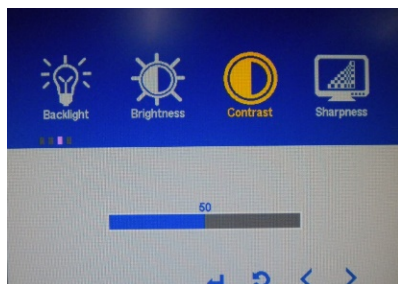

- Contrast

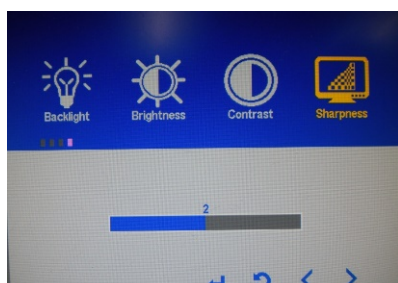
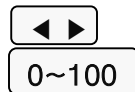

- Sharpness

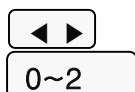

[Color Mode]

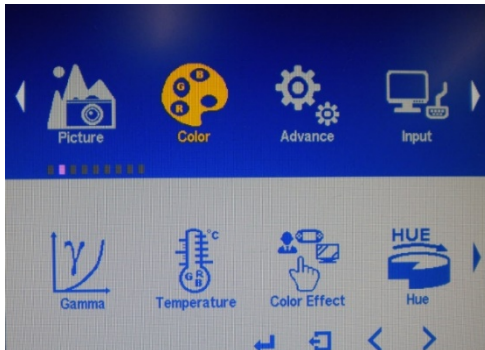

- Press ◀/▶ button to select Color mode. (Gamma, Temperature, Color effect, Hue, SAT)
- Select correspond item, press “DOWN”(▼) button or ◀/▶ button to enter in the submenu
- Press “UP”(▲) button to return to the previous menu or exit the present menu.

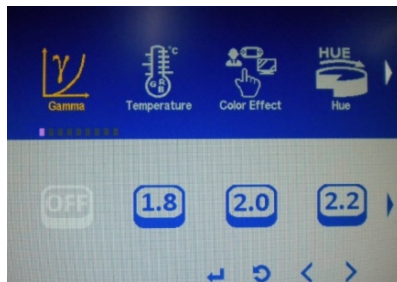
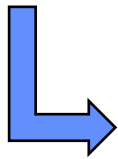

• Gamma

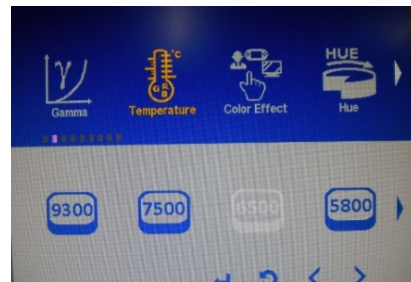

• Temperature

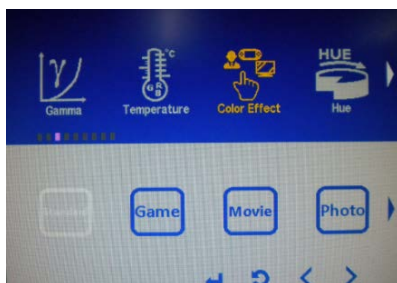

• Color Effect

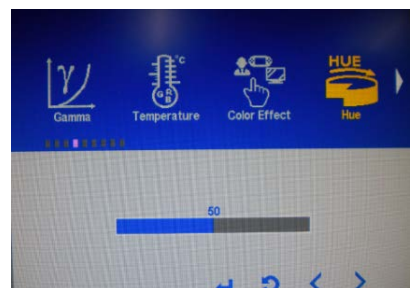

• HUE



0~100

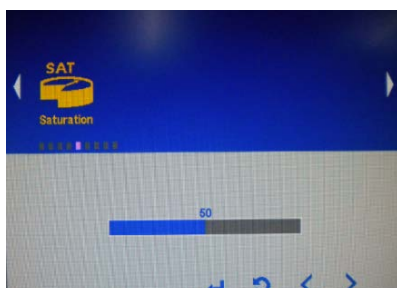

• SAT



0~100

[Advance Mode]

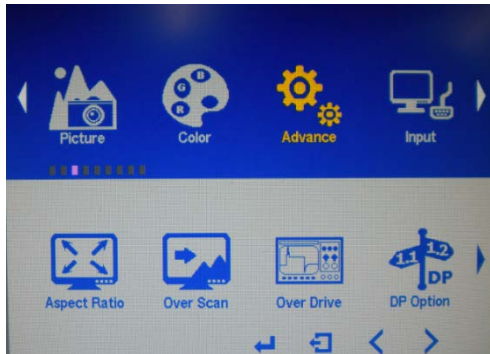

- Press ◀/▶ button to select advance mode. (Aspect ratio, Over Scan, Over Drive, DP Option, DP-EDID)
- Select correspond item, press “DOWN”(▼) button or ◀/▶ button to enter in the submenu
- Press “UP”(▲) button to return to the previous menu or exit the present menu.

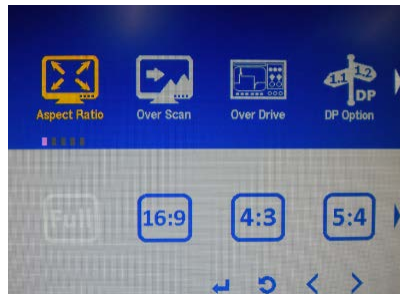
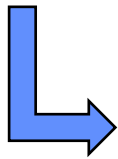

• Aspect Ratio

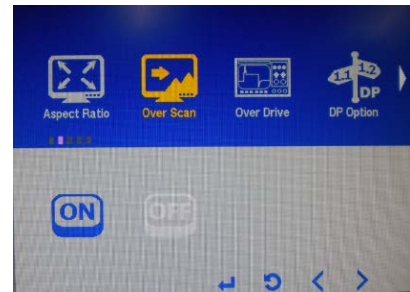

• Over Scan

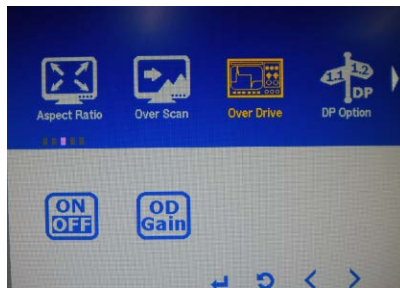

• Over Drive

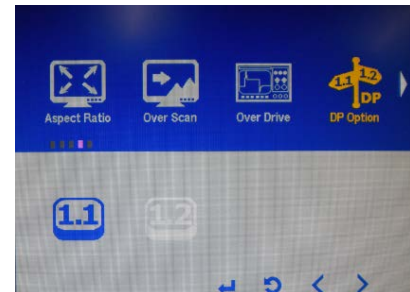

• DP Option



• DP-EDID

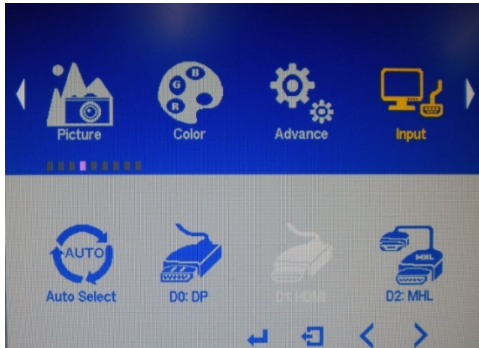

[Input Mode]

- Press ◀/▶ button to shift the cursor
- Press “DOWN” (▼) button to select signal source
- Press “UP” (▲) button to return to the previous menu or exit the present menu.
- Default set Auto Select

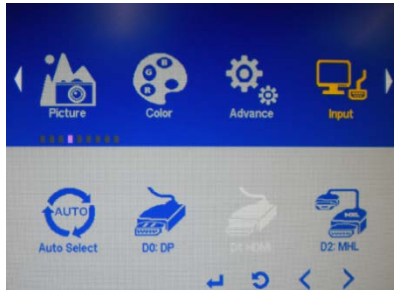
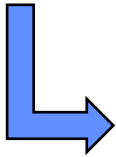

- Auto Select
- D0 : DP1
- D1 : DP2
- D2 : HDMI1
- D3 : HDMI2



[Other]

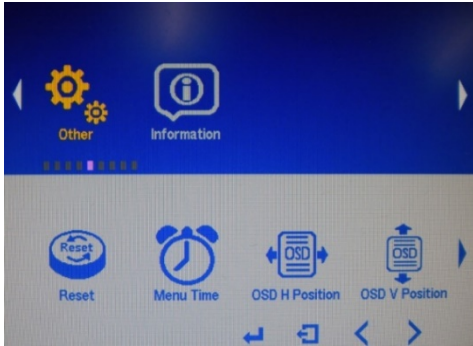

- Press ◀/▶ button to select Other mode. (Reset, Menu time, OSD H, V position, Language, OSD Transparency, OSD Rotate)
- Select correspond item, press “DOWN“(▼) button or ◀/▶ button to enter in the submenu
- Press “UP”(▲) button to return to the previous menu or exit the present menu.

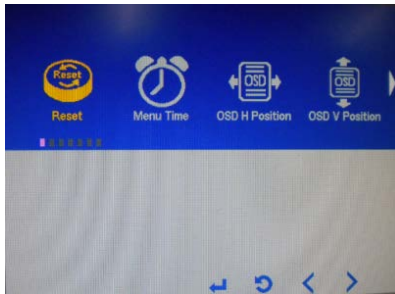
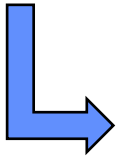

• Reset

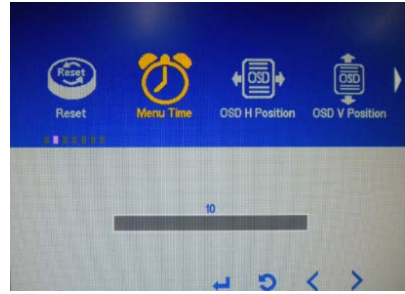

• Menu time

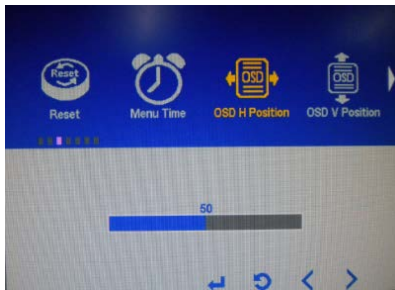

• OSD H position



0~100

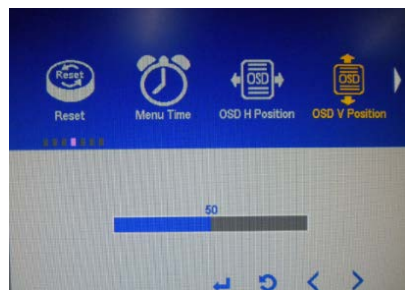

• OSD V position



0~100

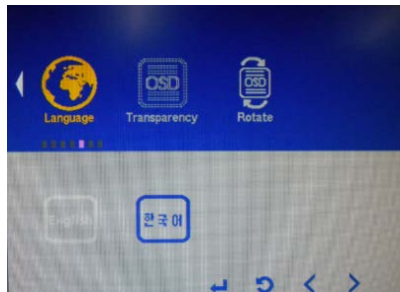

• Language

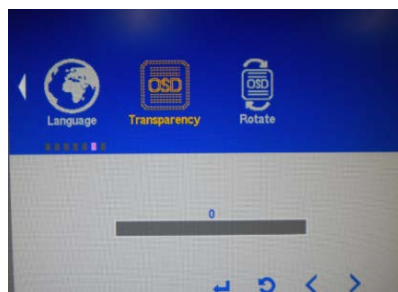

• OSD Transparency

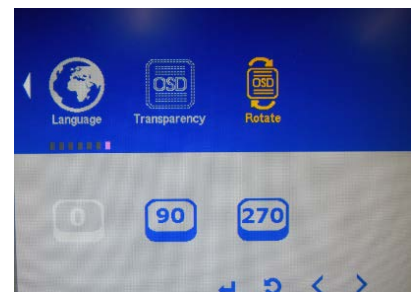

• OSD Rotate



5. Remote Control (Options)

- Use a remote control up to 7 meters distance and 30 degree (left/right) within the receiving unit scope.

-Format : NEC

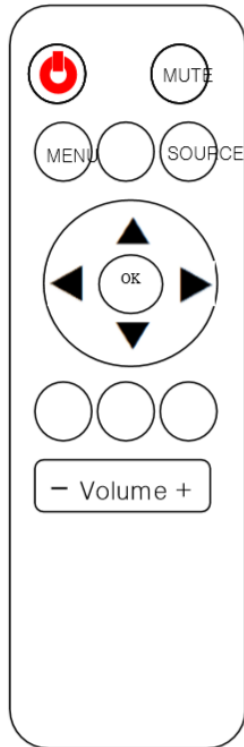

No	Button	Description
1	Power	• Switches the display power on and off
2	Mute	• Switches the audio on and off
3	Menu	• Enter the menu
4	Source	• Select the input video signal
5	(▲/▼)	• Up or Down shift
6	(◀/▶)	• Right or Left shift
7	OK	• Confirm the selection
8	- / +	• Increase or Decreases Volume level

6. Trouble shooting

Phenomenon	Confirmation and action
No Display	<ul style="list-style-type: none"> • Check that the Power code is properly connected to the display. • Check that Power on/off button on the OSD • Check that the signal cable is properly connected to the display. • Try disconnecting the video cable from the display and connecting to another display if available to confirm the presence of proper video. • Make sure the resolution mode is supported by the display and check display settings of the PC • Confirm that the video cables is not defective.
Image Persistence	<ul style="list-style-type: none"> • Image persistence occurs when a ghost of an image remains on the screen after the screen image has been changed. • The LCD monitor's image persistence is not permanent. To erase an image ghost, turn the monitor off for several hours. • What happens is the liquid crystals after extended periods of operation. • Check for proper Max. Resolution and Frequency.
Picture Quality & Image Stability	<ul style="list-style-type: none"> • Check for proper video cable for proper grounding and shielding. • Check the signal source for proper signal. • Check for proper adjustment of the Phase and Frequency controls. • Check for proper recommended signal timing.
Green LED not lit	<ul style="list-style-type: none"> • Check for proper power and power connections.
Display image is not properly sized	<ul style="list-style-type: none"> • Press the "Select" button to Auto Adjust the display. • Adjust the Vertical and Horizontal size controls via the OSD. • (Reference setup adjustments) • Ensure that a supported mode is selected on the display card or system being used. Consult the display card or system manual for proper video.
Display is present but "bar" Appear or roll across screen	<ul style="list-style-type: none"> • Ground contact problem between computer and display. • Interference from adjacent equipment.

Phenomenon	Confirmation and action
Image will not adjust	<ul style="list-style-type: none">• Video timing outside of range• Use the one-screen menu to adjust the clock setting.• Make sure timing is within VESA standard.
Slight distortion in text or Graphics	<ul style="list-style-type: none">• Not working in native resolution
Vertical shaded bars on Screen image	<ul style="list-style-type: none">• Horizontal size not properly adjusted. Adjust horizontal size
Image is not stable	<ul style="list-style-type: none">• Monitor has incorrect or bad sync signals.• Check for proper video cable installation.• Replace suspected faulty cable.• Check to ensure that video source is within the display's operating range.

7. Specification**(1) MONITOR SPECIFICATIONS**

ITEMS		SPECIFICATION
Panel	Screen Diagonal	64.53 inch
	Active Display Area	1428.48 x 803.52mm
	Display Type	Transmissive mode, Normally black
	Max. Resolution	3,840 x 2,160
	Display Colors	1.07B Colors, 10Bits(D)
	Pixel Pitch	0.372 x 0.372mm
	Brightness	500 cd/m ² (Typ.)
	Contrast Ratio	1100 : 1 (Typ.)
	Response Time (G to G)	8ms (Typ.)
	Viewing Angle	178°(H), 178° (V) Min.
	Lamp Life Time	50,000Hrs (Typ)
Input Video Signal		HDMI 2.0 x2, DP 1.2 x2
Audio	Input / Output	HDMI, DP / ø3.5 Phone Jack for Headphone, Speaker
	Speaker Output	10Wrms + 10Wrms (± 10%)
Control/OSD		Power, Menu, Source, Up , Down, LEFT/volume-, Right/Volume+
Indication LED		Power Off : Led Off , St-by : Red Blinking , Normal : Green
Power Input		AC 100V~240V (50/60Hz)
Power Management		VESA DPMS

(2) TOUCH SPECIFICATIONS

ITEMS	SPECIFICATION
Touch Type	PCAP (Projected Capacitive)
Touch Input Method	Finger
Number of Touch Point	10 Points Multi-Touch
Available Object size	ø9mm(Finger)
Response Time	16ms
Thickness	5.365mm(Glass : 5mm, Sensor : 0.365mm)
Transmittance	84%(Typ.)
Position Accuracy	Within 1.5mm
Interface	USB 2.0 FS, HID Compliant Plug & Play
Supported OS	Windows 7/8/10, Linux : above kernel Ver.3.0, Android : above Ver.4.0

(3) MECHANICAL SPECIFICATIONS

ITEMS	SPECIFICATION
Outline Dimension (HxVxD)	1530.4±1.2mm x 905.6±0.8mm x 63.6±0.3mm(Without Handle) 1530.4±1.2mm x 905.6±0.8mm x 67.6±0.3mm(Without Handle)
Weight(Net/ Gross)	67Kg Approx./ 75Kg Approx.
Standard Accessory	HDMI Cable, USB Cable, Power Cord, Remote control
VESA Mount Size	600 x 400 (mm) ,4-M6

(4) CONNECTOR INTERFACE

ITEMS	DESCRIPTION	
HDMI	HDMI 2.0 x2	
DP	DP 1.2 x2	
PC Audio Input	HDMI, DP	
Headphone Output	3.5ø Stereo Phone Jack	
USB (Touch Interface)	Connector	USB Type 'B' Female
	Power	USB Bus Powered
	Protocol	Human Interface Device(HID)
	Operation	Plug & Play
	Speed	USB 2.0 Full Speed

※Notice 1 : Do not set battery mode or power save mode in computer power option.

※Notice 2 : The standard of USB communication length is 5M(refer to usb.com)

When you use USB extension Cable, data loss and degradation might be able to be occurred.

In order to minimize data loss and degradation according to USB extension Cable using,

We highly recommend Repeater using to provide external power supply.

(5) ENVIRONMENTAL CONDITIONS

ITEMS	SEPECIFICATION
Operating Temperature	0 ~ 50 °C
Operating Humidity	10 ~ 90% (Non Condensing)
Storage Temperature	-20 ~ 60 °C
Storage Humidity	10 ~ 90% RH(Non Condensing)

(6) ELECTRICAL SPECIFICATIONS

ITEMS	SEPECIFICATION
Power Supply	AC 100V~240V (50/60Hz)
Power Consumption	Max. 2.1A