

DUKANE

DVP510
Document Camera

User Manual – English



[Important]

To download the latest version of Quick Start Guide, multilingual user manual, software, or driver, etc., please visit Dukane
[http:// www.dukaneav.com](http://www.dukaneav.com)

Table of Contents

Copyright Information	3
Chapter 1 Safety Instructions	4
Precautions	5
FCC Warning.....	5
EN55032 (CE Radiation) Warning	5
Chapter 2 Package Contents	6
Chapter 3 Product Overview	7
3.1 Relative Operation Position.....	7
Chapter 4 Installation and Connections	8
4.1 System diagram	8
4.2 Installation and setup.....	9
4.3 Connecting to a projector or monitor	9
4.4 Connecting to a Computer and Use Dukanes Software or an Interactive Whiteboard (IWB)	9
4.5 Connecting to an HDTV	10
4.6 For connection to Computer or DVD	10
4.7 Connecting to a computer, projector, and monitor simultaneously ..	11
4.8 Connecting to Audio Input and Output	11
4.9 Connecting to a computer with RS232.....	12
4.10 Connecting to a TV.....	12
4.11 Installing application software	13
Chapter 5 Start Using	14
Chapter 6 Control Panel/Remote Control and Setting Menu	15
6.1 Functions of control panel and remote control	15
6.2 Setting menu	17
Chapter 7 Descriptions of Major Functions	23
7.1 I would like to automatically adjust the image to have the best brightness and focusing performance	23
7.2 I would like to switch image sources	23
7.3 I would like to set the image source of VGA OUT2	23
7.4 I would like to switch the image mode.....	23
7.5 I would like to make text clearer and photos more colorful	23
7.6 I would like to zoom in/out images	24
7.7 I would like to use the manual focus	24

7.8	I would like to adjust the brightness	24
7.9	I would like to turn on/off the lamp.....	24
7.10	I would like to freeze images	24
7.11	I would like to rotate the image.....	25
7.12	I would like to capture images	25
7.13	I would like to record images.....	26
7.14	I would like to view captured/recorded images	27
7.15	I would like to delete the captured/recorded images.....	27
7.16	I would like to adjust the output volume	28
7.17	I would like to automatically delete the stored images whenever it is turned off (Auto Erase).....	28
7.18	I would like to enlarge a part of the image (PAN).....	28
7.19	I would like to use the MASK and Spotlight function.....	28
7.20	I would like to play the slides (Slide Show)	29
7.21	I would like to compare images (compare live images with stored image files (PIP)).....	30
7.22	I would like to reduce the image noise (Projector Type)	31
7.23	I would like to lock/unlock keys	31
7.24	I would like to change the power on image	31
7.25	I would like to use a USB disk	32
7.26	I would like to resume the factory default setting (Factory Reset) ...	32
7.27	Computer-related functions	33
Chapter 8 Connecting to Microscope		35
Chapter 9 Packing the Machine		37
Chapter 10 DIP switch setting.....		38
10.1	Connecting to a projector or monitor	38
10.2	Connecting to a TV/DVD	39
Chapter 11 Troubleshooting.....		40
Appendix 1		43

Copyright Information

Copyrights © Dukane Corp. All rights reserved.

Dukane is a trademark that is registered by Dukane Corp.

Copying, reproducing or transmitting this file is not allowed if a license is not provided by Dukane Corp. unless copying this file is for the purpose of backup after purchasing this product.

In order to keep improving the product, Dukane Corp. hereby reserves the right to make changes to product specifications without prior notice. The information in this file is subject to change without prior notice.

To fully explain or describe how this product should be used, this manual may refer to names of other products or companies without any intention of infringement.

Disclaimer of warranties: Dukane Corporation is neither responsible for any possible technological, editorial errors or omissions, nor responsible for any incidental or related damages arising from providing this file, using, or operating this product.

Chapter 1 Safety Instructions

Always follow these safety instructions when setting up and using the Document Camera:

1. Do not place Document Camera in tilted position.
2. Do not place the Document Camera on an unstable trolley, stand or table.
3. Do not use the Document Camera near water or source of heat.
4. Use attachments only as recommended.
5. Use the type of power source indicated on the Document Camera. If you are not sure of the type of power available, consult your dealer or local electricity company for advice.
6. Place the Document Camera on a place that it can be unplugged easily.
7. Always take the following precautions when handling the plug. Failure to do so may result in sparks or fire.
 - Ensure the plug is free of dust before inserting it into a socket.
 - Ensure that the plug is inserted into the socket securely.
8. Do not overload wall sockets, extension cords or multi-way plug boards as this may cause fire or electric shock.
9. Do not place the Document Camera where the cord can be stepped on as this may result in fraying or damage to the lead or the plug.
10. Unplug the Document Camera from the wall socket before cleaning. Use a damp cloth for cleaning. Do not use liquid or aerosol cleaners.
11. Do not block the slots and openings in the Document Camera case. They provide ventilation and prevent the Document Camera from overheating. Do not place the Document Camera on a sofa, rug or other soft surface or in a built-in installation unless proper ventilation is provided.
12. Never push objects of any kind through cabinet slots. Never allow liquid of any kind to spill into the Document Camera.
13. Except as specifically instructed in this User Manual, do not attempt to operate this product by yourself. Opening or removing covers may expose you to dangerous voltages and other hazards. Refer all servicing to licensed service personnel.
14. Unplug the Document Camera during thunderstorms or if it is not going to be used for an extended period. Do not place the Document Camera or remote control on top of vibrating equipment or heated objects such as a car, etc.
15. Unplug the Document Camera from the wall outlet and refer serving to licensed service personnel when the following situations happen:
 - If the power cord or plug becomes damaged or frayed.
 - If liquid is spilled into it or the Document Camera has been exposed to rain or water.





<Note> Using an incorrect battery type in the remote control may result in breakdown. Follow local instructions on how to dispose of used batteries.

■ Precautions

Warning: To reduce the risk of fire or electric shock, do not expose this appliance to rain or moisture.

This Document Camera has a 3-wire AC line Plug. This is a safety feature to ensure that the plug will fit into the power outlet. Do not try to disable this safety feature.

If the Document Camera will not be used for an extended time, unplug it from the power socket.

	<p>Note</p> <p>Risk of Electric Shock Please do not open it by yourself</p>		
<p>Caution: To reduce the risk of electric shock, do not remove cover (or back). No user-serviceable parts inside. Refer servicing to licensed service personnel.</p>			
	<p>This symbol indicates that this equipment may contain dangerous voltage which could cause electric shock.</p>		<p>This symbol indicates that there are important operating and maintenance instructions in this User Manual with this unit.</p>

■ FCC Warning

This Document Camera has been tested and found to comply with the limits for a Class A computer device, pursuant to Article 15-J of FCC Rules. These limits are designed to provide reasonable protection against harmful interference in a commercial installation.

This digital apparatus does not exceed the Class A limits for radio noise emissions from digital apparatus as set out in the interference-causing equipment standard entitled "Digital Apparatus," ICES-003 of Industry Canada.

■ EN55032 (CE Radiation) Warning

Warning: Operation of this equipment in a residential environment could cause radio interference.

Chapter 2 Package Contents

DVP510



Dukane Information sheet



Remote control



Remote Control Holder

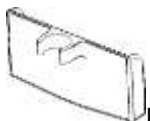

Power Adapter



Power cord



Appearance may vary depending on country/region

USB cable



VGA cable



Audio Cable



C-Video Cable



Microscope Adapter



HDMI Cable * 2



Chapter 3 Product Overview

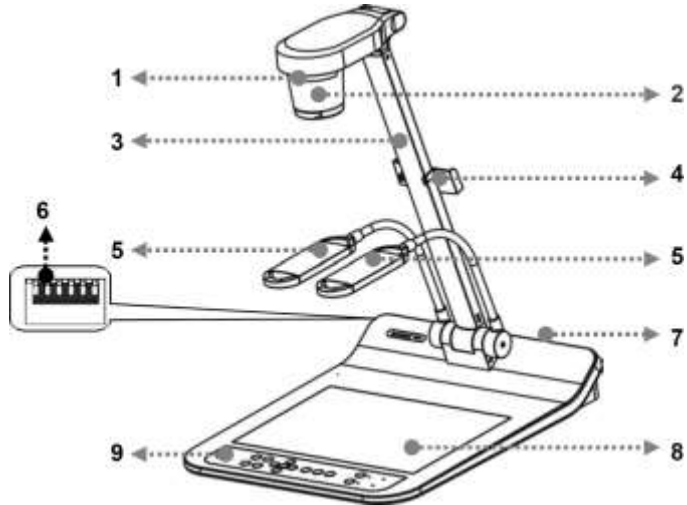

- | | |
|--------------------------------------|--------------------------|
| 1. Remote sensor | 2. Lens |
| 3. Camera arm | 4. Remote Control Holder |
| 5. Auxiliary floodlight and lamp arm | 6. DIP switch setting |
| 7. Input/output port | 8. Backlight |
| 9. Control panel | |

3.1 Relative Operation Position

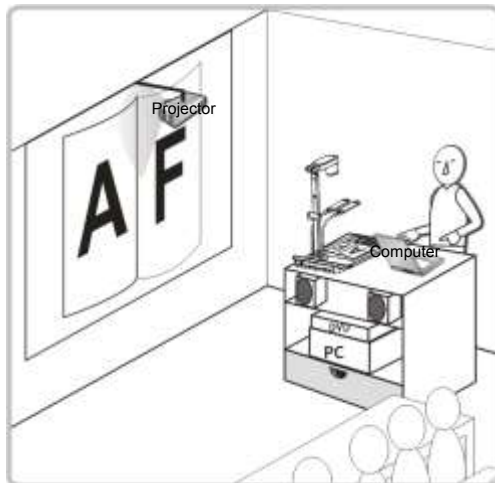

Chapter 4 Installation and Connections

4.1 System diagram

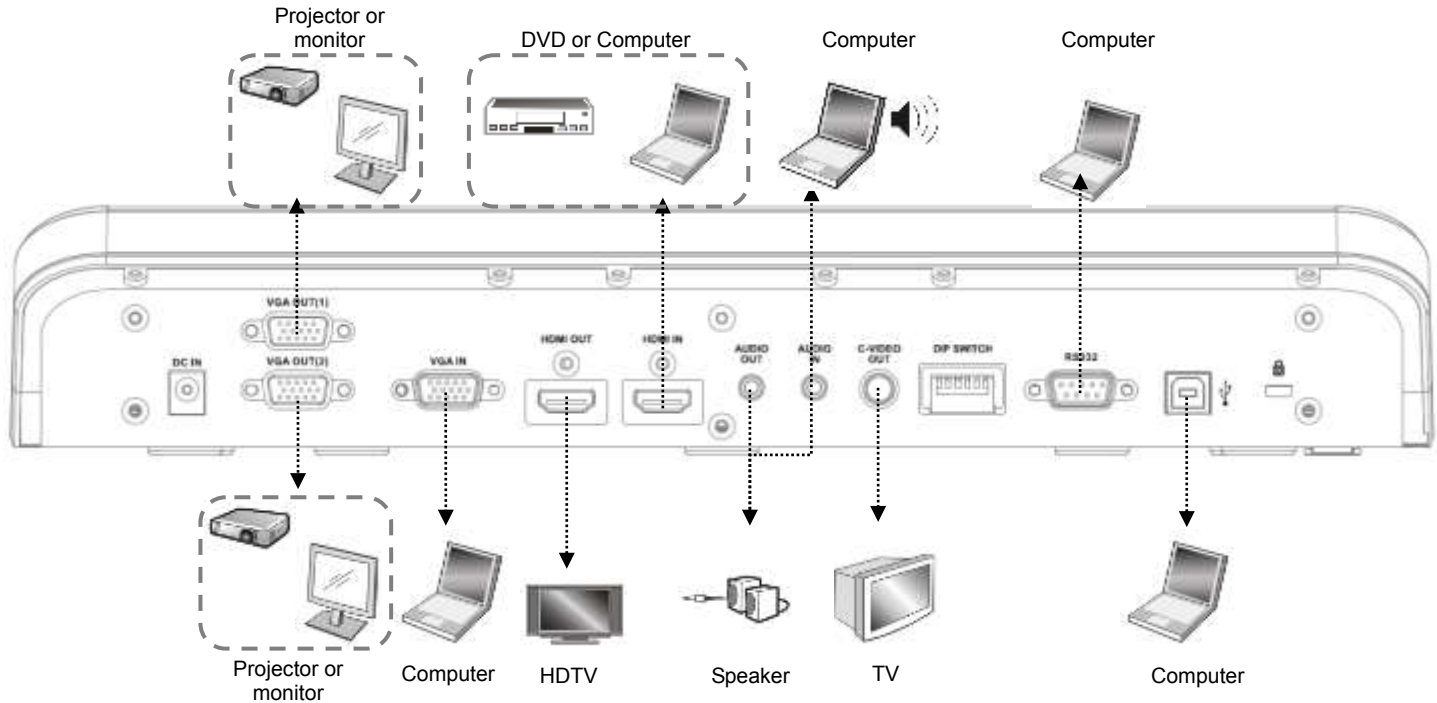

4.2 Installation and setup

1. Please set up the DIP switch setting first. Refer to [Chapter 10 DIP Switch Setting](#).

4.3 Connecting to a projector or monitor

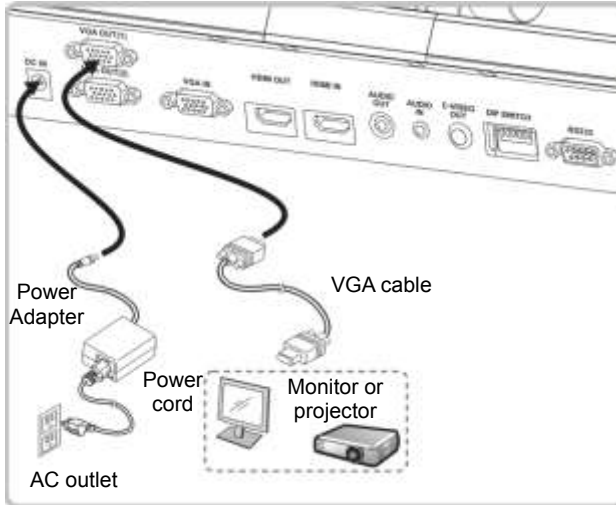

4.4 Connecting to a Computer and Use Dukanes Software or an Interactive Whiteboard (IWB)

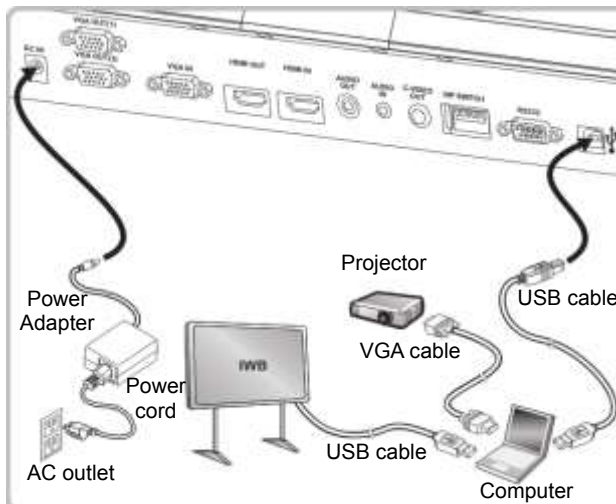

- The driver and software can be downloaded from Dukanes website.

4.5 Connecting to an HDTV

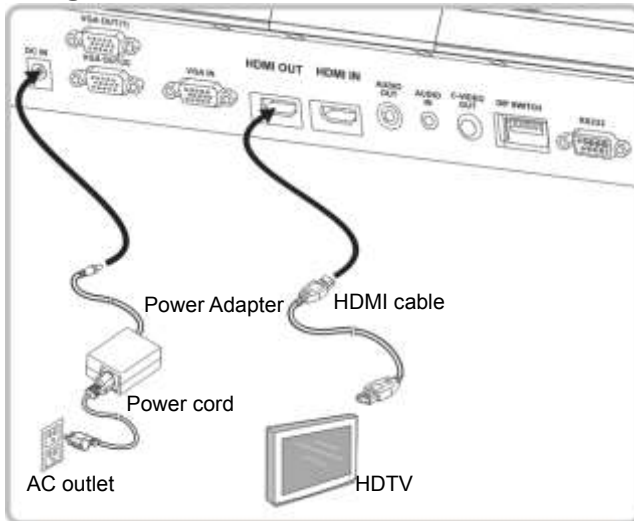

4.6 For connection to Computer or DVD

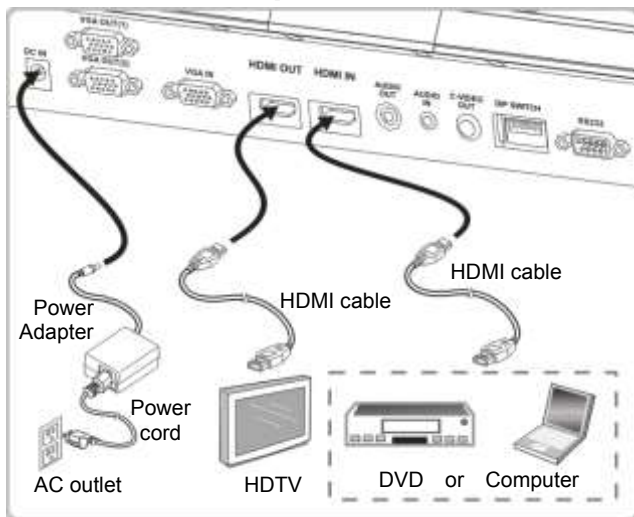

4.7 Connecting to a computer, projector, and monitor simultaneously

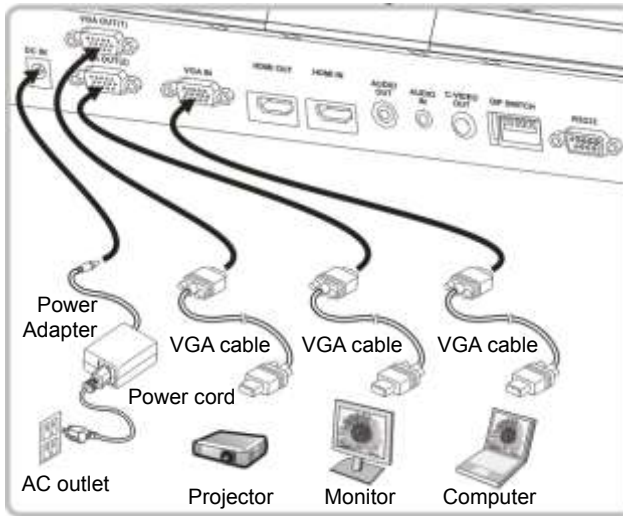

- Press [SOURCE] button to switch the image source.
- For VGA 1 setting, refer to [7.2 I would like to switch image sources.](#)
- For VGA 2 setting, refer to [7.3 I would like to set the image source of VGA OUT2.](#)

4.8 Connecting to Audio Input and Output

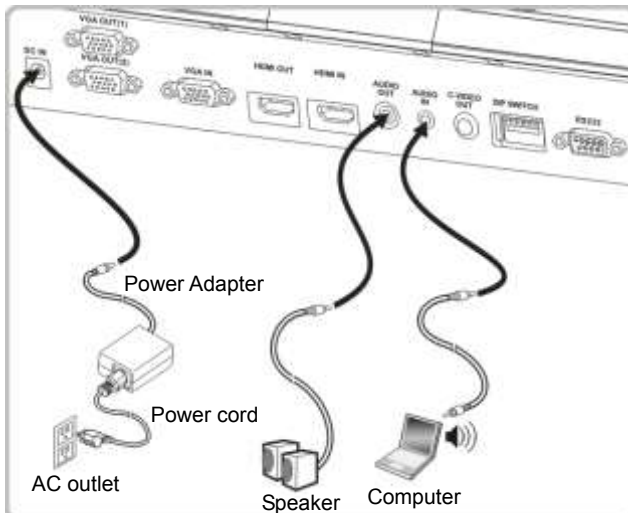

4.9 Connecting to a computer with RS232

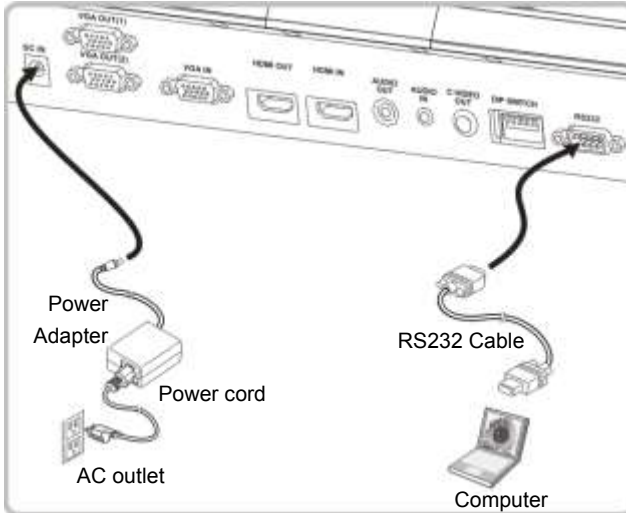

- After connecting to the RS232 cable, you can use RS232 commands to control DVP510.

4.10 Connecting to a TV

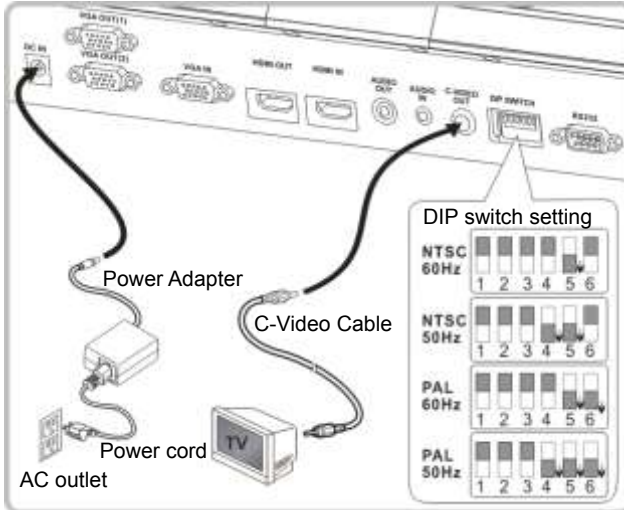

- NTSC: USA, Canada, Mexico, Panama, Chile, Japan, Taiwan, Korea, and Philippines.
- PAL: Countries/regions not listed above

<Note> You should unplug and reconnect the power cord, and then

restart the machine for DIP switch setting to take effect. Once C-VIDEO is enabled, VGA OUT is not supported.

<Note> Only the live image can be displayed in C-Video output mode.

4.11 Installing application software

The application software installed on the computer enables you to:



- Control the DVP510.
- Capture and record images.
- Annotate the image, highlight important details and save it.
- Support the full screen function.

<Note> Please refer to [B-Works2 software user manual](#) for installation steps and software operation.

Chapter 5 Start Using



<Note>: Please adjust it to be suitable for the local voltage frequency of 50/60 Hz. For the frequency in actual use, please refer to the manual ([Appendix 1](#)).

1. Remove the lens cap.
2. Pull up the lamp arm to a proper position.
3. Place an object to be displayed under the camera.
4. Press [POWER]  on the **remote control** or **control panel** to power on.
5. Press **control panel** [AUTO TUNE]  button to optimize the image.
You are ready to teach/present.
6. Each time the camera head is moved, press [AUTO TUNE]  on the **remote control** or **control panel** to refocus the lens.









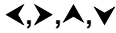

<Note>: According to your request, you can adjust the camera head slightly to aim at the center of the documents when the anchor of lens was reached.

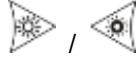





- When using the remote control, aim at the remote sensor on the DVP510, and press the power button.
- Once DVP510 is turned on, the LED on the control panel will flash a few times and stay lit. Please contact your distributor if the LED does not light up.

Chapter 6 Control Panel/Remote Control and Setting Menu

6.1 Functions of control panel and remote control

<Remark> The below functions are listed alphabetically

Name	Function Descriptions	Operation
	Turn on and off the Document Camera.	Remote control/ Control panel
	Move up, down, left or right to select the needed function.	Remote control/ Control panel
AUTO TUNE 	Automatically adjust the image to have the best brightness and focusing performance.	Remote control/ Control panel
BRT+/- 	Adjust the brightness of the image.	Remote control/ Control panel
CAPTURE /DEL 	Capture and save images to USB disk (priority) or internal memory while displaying live images. Delete files from the USB disk (priority) or internal memory while reading the stored files (in Playback mode).	Remote control/ Control panel
ENTER 	Activate/Enter functions.	Remote control/ Control panel
FREEZE 	Freeze the current image to remain temporarily on the screen. Press again to defreeze.	Remote control/ Control panel
LAMP 	Lamp mode toggle switch.	Remote control/ Control panel
MASK 	Activate Mask/Spotlight mode.	Remote control
MENU 	Activate the setting menu/exit the menu.	Remote control/ Control panel
PAN 	Enable/Disable the partial enlarged mode.	Remote control















PIP 	Image comparison (to compare live images with stored image files).	Remote control
PLAYBACK 	Read files stored in the USB disk (priority) or internal memory.	Remote control/ Control panel
RECORD 	Record motion images. Press [Record] to record images to USB disk and press [Record] again to stop recording.	Remote control/ Control panel
ROTATE 	Screen rotation 0°/180°/Flip/Mirror	Remote control
SOURCE 1 	Switch between different image sources of VGA OUT (1) and HDMI OUT : 1. Live images (default). 2. VGA IN / HDMI IN.	Remote control/ Control panel
SOURCE 2 	Switch between different image sources of VGA OUT (2) VGA Out (VGA OUT(1)) / VGA IN	Control panel
ZOOM +/- 	Increase or decrease the image size.	Remote control/ Control panel

6.2 Setting menu

6.2.1 Main menu

<Remark> Press **[MENU]** on the **remote control** or **control panel** to display the setting menu.



	Auto Tune Automatically adjust the image to have the best brightness and focusing performance.		Slide Show Show the photos or videos stored in the USB disk (priority) or internal memory in slide mode.
	PAN Enable/Disable the partial enlarged mode.		Manual Focus Manual Focus.
	LAMP Lamp mode toggle switch.		Rotate Screen rotation 0°/180°/Flip/Mirror
	PIP Image comparison (to compare live images with stored image files).		Settings Set up various functions.
	Brightness Adjust the brightness of the image.		Photo/Text Select Photo/Text/Gray Mode.
	Mask Activate the mask mode.		Zoom Increase or decrease the image size.
	Mode Select image mode.		Spotlight Activate the spotlight mode.

6.2.2 Setting menu

1 st Level Major Items	2 nd Level Minor Items	3 rd Level Adjustment Values	Function Descriptions
Capture	Capture Mode	<u>Single Capture</u> / Time Lapse/ Record/Disable	Use the left and right arrow keys to select capture mode.
	Capture Time	1. <u>1 hr</u> 2. 2 hr 3. 4 hr 4. 8 hr 5. 24 hr 6. 48 hr 7. 72 hr	Use the left and right arrow keys to select the capture time. <Note> This will be active only when capture mode is set to time lapse
	Capture Interval	1. 3 sec 2. <u>5 sec</u> 3. 10 sec 4. 30 sec 5. 1 min 6. 2 min 7. 5 min	Use the left and right arrow keys to select the capture interval. <Note> This will be active only when capture mode is set to time lapse
	Image Quality	1. High 2. <u>Medium</u> 3. Low	Use the left and right arrow keys to select the image quality for the captured images and recorded videos
Storage	Slide Show	<u>Enter</u>	Show the photos or videos stored in the USB disk (priority) or internal memory in slide mode.
	Delay	1. 0.5 sec 2. <u>1 sec</u> 3. 3 sec 4. 5 sec 5. 10 sec 6. Manual	Use the left and right arrow keys to select the delay time. Select manual mode to switch images manually.
	Copy To USB Disk	<u>Enter</u>	Use the left and right arrow keys to select, and then press [ENTER] to confirm to copy files from internal memory to USB disk.
	Delete All	Yes/ <u>No</u>	Use the left and right arrow keys to select, press [ENTER] to confirm the deletion of all images from the USB disk (priority) or internal memory.
	Format	Yes/ <u>No</u>	Use the left and right arrow keys to select, and then press [ENTER] to format the USB disk (priority) or internal memory.

Control	Auto Exposure	<u>On</u> /Off	Regardless of outside environment, the machine will adjust the brightness to the optimal condition. Use the left and right arrow keys to select.
	Auto White Balance	<u>Enter</u>	Regardless of outside light or color, the machine will adjust the color to the optimal condition; Press [ENTER] to execute.
	Audio Out Volume	0~ <u>A</u> ~Max	Use the left and right arrow keys to adjust the volume.
	Microphone Levels	0~ <u>A</u> ~Max	Use the left and right arrow keys to adjust the volume.
	Projector Type	<u>DLP</u> /LCD	Use the left and right arrow keys to select the projector type and reduce image noise.
	Digital Zoom	On/ <u>Off</u>	Use the left and right arrow keys to turn on/off digital zoom .
	Auto Power On	<u>On</u> /Off	Powers on automatically when connected to power supply
Advanced	Language	<ol style="list-style-type: none"> 1. <u>English</u> 2. 繁體中文 3. 简体中文 4. Deutsch 5. Français 6. Español 7. Русский 8. Nederlands 9. Suomi 10. Polski 11. Italiano 12. Português 13. Svenska 14. dansk 15. ČESKY 16. العربية 17. 日本語 18. 한국의 19. ελληνικά 	<p><u>English</u> Traditional Chinese Simplified Chinese German French Spanish Russian Dutch Finnish Polish Italian Portuguese Swedish Danish Czech Arabic Japanese Korean Greek</p> <p>Use the left and right arrow keys in the Language option to select the preferred language.</p>

	Lock Down	On/ <u>Off</u>	Use the left and right arrow keys to turn on/off the lock down function. You can set the password when [On] is selected.
	Auto Erase	On/ <u>Off</u>	Use the left and right arrow keys to turn on/off the auto erase function. When [On] is selected, the stored images will automatically be deleted when the system is turned off.
	Preset Load	Yes/ <u>No</u>	Read the value of the current image mode. Use the left and right arrow keys to select, and then confirm by pressing [ENTER].
	Preset Save	Yes/ <u>No</u>	Store the value of the current image mode. Use the left and right arrow keys to select, and then confirm by pressing [ENTER].
	Splash Screen Settings	<u>Enter</u>	Open Splash Screen Setting window
	Factory Reset	Yes/ <u>No</u>	Use the left and right arrow keys to select, and then confirm by pressing [ENTER] to restore the factory defaults.
	Firmware Version	NA	Display FW version

6.2.3 Mask mode setting menu

2 nd Level Major Items	3rd Level Minor Items	4 th Level Adjustment Values	Function Descriptions
MASK Mode	Live	<u>Enter</u>	Press [ENTER] to return to live image.
	Transparency	0~ <u>2</u> ~3	Use the left and right arrow keys to adjust the transparency of the mask.
	Step	Large/ <u>Medium</u> /Small	Use the left and right arrow keys to select the step of the mask.
	V Size	0~ <u>A</u> ~Max	Use the left and right arrow keys to select the vertical height of the mask.
	H Size	0~ <u>A</u> ~Max	Use the left and right arrow keys to select the horizontal length of the mask.

	Exit	<u>Enter</u>	Press [ENTER] to confirm your selection and exit the mask mode setting menu.
--	-------------	---------------------	--

6.2.4 Spotlight mode setting menu

2 nd Level Major Items	3rd Level Minor Items	4 th Level Adjustment Values	Function Descriptions
Spotlight Mode	Live	<u>Enter</u>	Press [ENTER] to return to live image.
	Shape	<u>Ellipse</u>/Rectangle	Use the left and right arrow keys to select the shape of the spotlight zone.
	Transparency	0~ <u>2</u> ~3	Use the left and right arrow keys to adjust the transparency of the border in the spotlight mode.
	Step	Large/ <u>Medium</u> /Small	Use the left and right arrow keys to select the step of the spotlight zone.
	V Size	0~ <u>A</u> ~Max	Use the left and right arrow keys to adjust the height of the spotlight zone.
	H Size	0~ <u>A</u> ~Max	Use the left and right arrow keys to adjust the width of the spotlight zone.
	Exit	<u>Enter</u>	Press [ENTER] to confirm your selection and exit the spotlight mode setting menu.







6.2.5 Splash Screen Setting

2 nd Level Major Items	3rd Level Minor Items	4 th Level Adjustment Values	Function Descriptions
Splash Screen Setting	Power On Image Setting	<u>Default</u>/Customer	Select to use [Default/ Customer] power on image
	Power On Logo Show Time	4 ~ 30 sec	Set up power on logo show time
	Power On Image Select	<u>Enter</u>	Select power on image. Only pictures in JPEG format are supported
	Exit	<u>Enter</u>	Press [ENTER] to confirm your selection and exit splash screen setting window.



6.2.6 Annotation Tools

After the mouse is connected, right click or left click and hold the mouse to start the tools.

<Note> When the setting menu is activated, the tools cannot be used.

Icon	Description
	Custom tool 1
	Custom tool 2
	Eraser
	Clear all
	Open setting menu of the annotation tool
	Exit the annotation tool

6.2.7 Setting menu of the annotation tool

2 nd Level Major Items	3rd Level Minor Items	4 th Level Adjustment Values	Function Descriptions
	Tools Select	<u>Pen</u> /Line/ Ellipse / Rectangle	Select an annotation tool
	Color Select	<u>Red</u> /Blue/Black/ Green/Pink/White/Cyan/Yellow	Select the pen color
	Line Width	1~ <u>3</u> ~10	Select the line width
	Tools Select	<u>Pen</u> /Line/ Ellipse / Rectangle	Select an annotation tool
	Color Select	Red/ <u>Blue</u> /Black/ Green/Pink/White/Cyan/Yellow	Select the pen color
	Line Width	1~ <u>3</u> ~10	Select the line width
	Line Width	1~ <u>3</u> ~10	Select the line width

Chapter 7 Descriptions of Major Functions

7.1 I would like to automatically adjust the image to have the best brightness and focusing performance

Use the remote control or control panel:

1. Press [AUTO TUNE] for the best brightness and focusing performance.

7.2 I would like to switch image sources

Live image is the default image source of VGA OUT (1) and HDMI OUT.

Press [SOURCE]  on the **remote control or control panel** to have

DVP510 switch among the following images sources:

1. Live images (default).
2. VGA IN /HDMI IN

7.3 I would like to set the image source of VGA OUT2

The default of image source is based on VGA OUT (1). Press [SOURCE 2]



on the **control panel** to have DVP510 switch among the following images sources:

1. VGA OUT(1).
2. VGA IN.

7.4 I would like to switch the image mode

Use the remote control or control panel:

- 1 Press [MENU] to activate the setting menu.
- 2 Press [▲], [▼], [▶], or [◀] to select [Image Mode].
- 3 Press [▶] or [◀] to the [Normal/Film/Slide/Microscope].
- 4 Press [MENU] to exit.

7.5 I would like to make text clearer and photos more colorful

7.5.1 Photo/Text mode descriptions

The default [Photo/Text] mode is in Photo (**Photo mode**). To change this setting, please use the **remote control** or the **control panel** to activate the options of the setting menu.

- [Photo] (default): for viewing photos or text with photos, making photos more colorful.
- [Text]: for viewing text files, making the text clearer.

- [Gray]: for viewing black & white photos which will make the grayscale differentiation distinct.

7.5.2 Set up Photo/Text mode

To change the settings, please use the **remote control** or the **control panel**:

1. Press [MENU] to activate the setting menu.
2. Press [▲], [▼], [▶], or [◀] to select [Photo/Text]. (Please refer to [7.5.1 Photo/Text mode descriptions](#) to make the best choice.)
3. Press [ENTER] to activate.
4. Press [▶] or [◀] to select the [Photo/Text/Gray].
5. Press [MENU] to exit.

7.6 I would like to zoom in/out images

1. Press [ZOOM+] on the **remote control** or **control panel** to zoom in images.
2. Press [ZOOM-] on the **remote control** or **control panel** to zoom out images.

7.7 I would like to use the manual focus

Use the remote control or control panel:

1. Press [MENU] to activate the setting menu.
2. Press [▲], [▼], [▶], or [◀] to select [Manual Focus].
3. Press [MENU] to exit.

7.8 I would like to adjust the brightness

If you use the remote control or the control panel:

1. Press [BRT +] to make it brighter.
2. Press [BRT -] to make it darker.

7.9 I would like to turn on/off the lamp

The default of the lamp is **Arm lamp**. When using the **remote control** or **control panel**:

1. Press [LAMP] to switch On/Off. (in the sequence of arm lamp/backlight/OFF)

7.10 I would like to freeze images

1. Press [FREEZE] on the **remote control** or **control panel** to freeze the

current image on the screen. Press again to defreeze.

7.11 I would like to rotate the image

Remote control:

1. Press [ROTATE] key to rotate the screen. (The sequence of switching is: 0°/180°/Flip/Mirror)

Control panel:

1. Press [MENU] to activate the setting menu.
2. Press [▲], [▼], [▶], or [◀] to select [Rotate].
3. Press [ENTER] to activate.
4. Press [▶] or [◀] to switch the rotation method. (The sequence of switching is: 0°/180°/Flip/Mirror)
5. Press [MENU] to exit.

7.12 I would like to capture images

7.12.1 Capture and save images

1. Press [CAPTURE/DEL] on the **remote control** or **control panel** to capture and save images.
 - **You cannot capture images when the capture mode is set to [Disable]. If it is set to [Continuous], you can capture images continuously. Press [CAPTURE/DEL] to start capturing continuously, or press [CAPTURE/DEL] again to exit.**
 - **To change the quality of captured images, please refer to [7.12.2 Setting the quality of captured images](#).**
 - **To change the settings of captured images, please refer to [7.12.3 Setting continuous capture](#).**

7.12.2 Setting the quality of captured images

1. Press [MENU] on the **remote control** or **control panel** to activate the setting menu.
2. Press [▲], [▼], [▶], or [◀] to select [Setting].
3. Press [ENTER] to activate.
4. Press [▶] or [◀] to the [Capture] menu.
5. Press [▼] to find [Image Quality].
6. Press [▶] or [◀] to select among [High/Medium/Low].
7. Press [MENU] to exit.

7.12.3 Setting continuous capture

1. Press [MENU] on the **remote control** or **control panel** to activate the setting menu.

2. Press [▲], [▼], [▶], or [◀] to select [Setting].
3. Press [ENTER] to activate.
4. Press [▶] or [◀] to the [Capture] menu.
5. Press [▼] to the [Capture Mode].
6. Press [▶] or [◀] to select [Time Lapse].
7. Press [▼] to find [Capture Time]; Press [▶], or [◀] to set capture time.
8. Press [▼] to find [Capture Interval]; Press [▶], or [◀] to set interval time.
9. Press [MENU] to exit.

7.13I would like to record images

<Note> Connect USB disk to DVP510 to start recording images.

7.13.1 Recording motion images

<Remark> You may not be able to capture or record images when [Capture Image] mode is set to [Disable].

Use the remote control or control panel:

1. Press [RECORD] on the **remote control** to start recording images.
2. Record sounds with the built-in microphone of the control panel.
3. Press [RECORD] again to stop recording.

7.13.2 Setting the quality of captured images

1. Press [MENU] on the **remote control** or **control panel** to activate the setting menu.
2. Press [▲], [▼], [▶], or [◀] to select [Setting].
3. Press [ENTER] to activate.
4. Press [▶] or [◀] to the [Capture] menu.
5. Press [▼] to find [Image Quality].
6. Press [▶] or [◀] to select among [High/Medium/Low].
7. Press [MENU] to exit.

7.13.3 Recording setup

1. Press [MENU] on the **remote control** or **control panel** to activate the setting menu.
2. Press [▲], [▼], [▶], or [◀] to select [Setting].
3. Press [ENTER] to activate.
4. Press [▶] or [◀] to the [Capture] menu.
5. Press [▼] to the [Capture Mode].
6. Press [▶] or [◀] to select [Record].
7. Press [MENU] to exit.

<Remark> When the [Capture Image] mode is set to [Record], the function of [Capture] on the control panel is changed to image recording.

7.13.4 Adjust the volume of microphone

1. Press [MENU] on the **remote control** or **control panel** to activate the setting menu.
2. Press [▲], [▼], [▶], or [◀] to select [Setting].
3. Press [ENTER] to activate.
4. Press [▶] or [◀] to the [Control] menu.
5. Press [▼] to the [MIC Vol.].
6. Press [▶] or [◀] to adjust the volume.
7. Press [MENU] to exit.

7.13.5 Playing images

- For playing videos, please refer to [7.14 I would like to view captured/recorded images.](#)

7.14 I would like to view captured/recorded images

1. Press [PLAYBACK] on the **remote control** or **control panel** to display thumbnails of all stored files.
2. Press [▲], [▼], [▶], or [◀] to select the thumbnail you want to play.
3. Press [ENTER] to play.
4. When the video is played, press [FREEZE] to pause/play the video or press [ENTER] to stop playing.
5. Press [▶] or [◀] to select the next or previous audio/video file.
6. Press [▲] or [▼] to adjust the volume of the video.
7. Press [MENU] to exit.

<Note> An external speaker must be connected to AUDIO OUT to play sound when you use VGA OUT.

7.15 I would like to delete the captured/recorded images

Use the **remote control** or **control panel**:

1. Press [PLAYBACK] to show the thumbnails of all stored files.
2. Press [▲], [▼], [▶], or [◀] to select the file you want to delete.
3. Press [CAPTURE/DEL] to display a [Delete File] window.
4. Press [▶] or [◀] to select [Yes].
5. Press [ENTER] to delete the selected file.
6. Press [MENU] to exit.

7.16 I would like to adjust the output volume

<Note> Volume control is intended to control the external audio output equipment only.

Adjust the volume of the video.

1. In PLAYBACK mode, Press [▲] or [▼] to adjust the volume of the video.

7.17 I would like to automatically delete the stored images whenever it is turned off (Auto Erase)

Use the **remote control** or **control panel**:

1. Press [MENU] to activate the setting menu.
2. Press [▲], [▼], [▶], or [◀] to select [Setting].
3. Press [ENTER] to activate.
4. Press [▶] or [◀] to the [Advanced] menu.
5. Press [▲] or [▼] to [Auto Erase].
6. Press [▶] or [◀] to select [On].
7. Press [MENU] to exit.

7.18 I would like to enlarge a part of the image (PAN)

Use **remote control**:

1. Press [PAN] to activate the partial enlarged mode.
2. Press [▲], [▼], [▶], or [◀] to move and view the partial enlarged images.
3. Press [MENU] to exit the partial enlarged mode.

Use **control panel**:

1. Press [MENU] to activate the setting menu.
2. Press [▲], [▼], [▶], or [◀] to select [PAN].
3. Press [ENTER] to execute.
4. Press [▲], [▼], [◀], or [▶] to move and view the partial enlarged images.
5. Press [MENU] to exit the partial enlarged mode.

7.19 I would like to use the MASK and Spotlight function

7.19.1 I would like to use the mask or spotlight mode

Use **remote control**:

1. Press [MASK] key to enter the Mask/Spotlight mode menu. Press [◀] or [▶] to select mode.
2. Press [ENTER] to enter the mask or spotlight mode.
3. Press [▲], [▼], [◀], or [▶] to move the zone position.

4. Press [MASK] again to return to live image.

Use control panel:

1. Press [MENU] to activate the setting menu.
2. Press [▶] or [◀] to select [Mask]. Press [ENTER] to activate mask mode or select [Spotlight] and press [ENTER] to activate spotlight mode.
3. Press [▲], [▼], [◀], or [▶] to move the zone position.
4. Press [MENU] to activate the image OSD menu.
5. Press [▲] or [▼] to select [Live Image].
6. Press [ENTER] to return to live image.

7.19.2 I would like to set the size of mask

In Mask mode, use the **remote control or control panel**:

1. Press [MENU] to activate the image OSD menu.
2. Press [▲] or [▼] to select the item to be modified
[Transparency/Step/
V Size/H Size]. (**For details, please refer to [6.2 Setting Menu.](#)**)
3. Press [◀] or [▶] to perform the modification.
4. Press [MENU] to exit the image OSD menu and return to the mask mode.

7.19.3 I would like to set spotlight function

In Spotlight mode, use the **remote control or control panel**:

1. Press [MENU] to activate the image OSD menu.
2. Press [▲] or [▼] to select the item to be modified
[Shape/Transparency/ Step/V Size/H Size]. (**For details, please refer to [6.2 Setting Menu.](#)**)
3. Press [◀] or [▶] to perform the modification.
4. Press [MENU] to exit the image OSD menu and return to spotlight mode.

7.20 I would like to play the slides (Slide Show)

7.20.1 Setting delay time

1. Press [MENU] on the **remote control or control panel** to activate the setting menu.
2. Press [▲], [▼], [▶], or [◀] to select [Setting].
3. Press [ENTER] to activate.
4. Press [▶] or [◀] to the [Storage] menu.
5. Press [▼] to find [Delay].
6. Press [▶] or [◀] to select the delay time between [0.5 sec/1 sec/

3 sec/5 sec/10 sec/Manual].

7. Press [MENU] to exit.

7.20.2 Playing/Pausing/Stopping the slide show

<Note> Upper limit: The maximum size of single photo is 7 MB.

If you use the remote control or the control panel

1. Press [MENU] to activate the setting menu.
2. Press [▲], [▼], [▶], or [◀] to select [Slide Show].
3. Press [ENTER] to play.
4. Press [ENTER] again to pause/play.
5. Press [MENU] to exit.

7.21 I would like to compare images (compare live images with stored image files (PIP))

This function will compare and contrast a live image with a stored image.

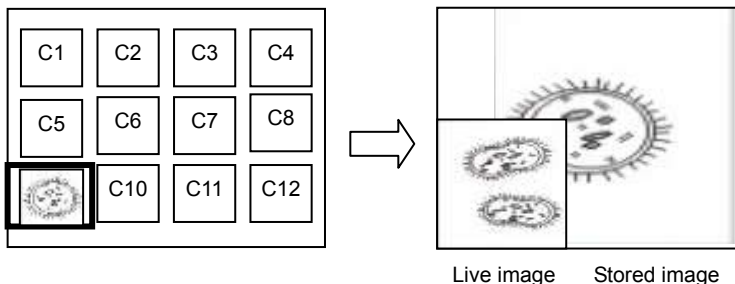

Remote control:

1. Press [Playback] to activate the Playback image thumbnails.
2. Press [▲], [▼], [◀], or [▶] to select the file to be compared.
3. Press [PIP] to execute image comparison.
4. Press [▲], [▼], [◀], or [▶] to move the live image.
5. Repeat Steps 1 - 3 to change other image files.
6. Press [MENU] to exit.

Control panel:

1. Press [MENU] to activate the setting menu.
2. Press [▲], [▼], [▶], or [◀] to select [PIP].
3. Press [ENTER] to activate image comparison.
4. Press [▲], [▼], [◀], or [▶] to move the live image.
5. Press [MENU] to exit.

7.22 I would like to reduce the image noise (Projector Type)

1. This function enables Document Camera to automatically clear image noise. The noise is especially obvious when Document Camera is connected to a DLP projector. You can set the DLP projector to improve the image quality.
2. If there is special noise when VGA OUT is connected, please set DLP option to improve the image quality.



- 2.1. Press [MENU] on the **remote control** or **control panel** to activate the setting menu.
- 2.2. Press [▲], [▼], [▶], or [◀] to select [Setting].
- 2.3. Press [ENTER] to activate.
- 2.4. Press [▶] or [◀] to select [Control].
- 2.5. Press [▼] to [Projector Type].
- 2.6. Press [▶] or [◀] to select [LCD/DLP].
- 2.7. Press [MENU] to exit.

7.23 I would like to lock/unlock keys

Press and hold [ENTER + LAMP] on the control panel for 2 seconds to lock keys. To unlock keys, repeat the above procedure.

<Remark> This function applies to the keys of the control panel only. The remote control can still be used. If you use the remote control to turn off the power, the keys will be unlocked automatically after reboot.

7.24 I would like to change the power on image

<Note> The power on image file must be less than 5 MB and in JPEG format.

<Note> To save the file, please follow the instruction below:

File path: \DCIM\100MEDIA, for example: J: \DCIM\100MEDIA
File name: four English letters+ four numbers, for example:
LUMN0001.JPG

1. Press [MENU] on the **remote control** or **control panel** to activate the setting menu.
2. Press [▲], [▼], [▶], or [◀] to select [Setting].
3. Press [ENTER] to activate.
4. Press [▶] or [◀] to select [Advanced] menu.
5. Press [▼] to select [Power On Image Setting].
6. Press [ENTER] to activate.
7. Press [▲] or [▼] to select [Power On Image Setting] and press [▶] or [◀] to select [Default/Custom].
8. Press [▲] or [▼] to select [Power On Logo Show time] and press [▶] or [◀] to set up the time.
9. Skip to Step 11 if you select [Default] in Step 7.
10. Press [▲] or [▼] to [Power On Image Select] and press [ENTER] to read selected file.
11. Press [▼] to [Exit] and press [ENTER] to exit.

7.25I would like to use a USB disk

1. Insert the USB disk and a [Copy To USB Disk] dialog box will appear, and you are asked whether to copy files from DVP510 to the USB disk.
 - Press [▶] or [◀] on the **remote control** or **control panel** to select.

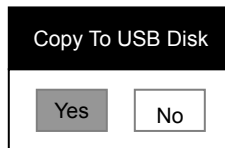

7.26I would like to resume the factory default setting (Factory Reset)

7.26.1 Using OSD menu

1. Press [MENU] on the **remote control** or **control panel** to activate the setting menu.
2. Press [▲], [▼], [▶], or [◀] to select [Setting].
3. Press [ENTER] to activate.
4. Press [▶] or [◀] to select [Advanced] menu.
5. Press [▼] to select [Factory Reset].
6. Press [▶] or [◀] to select [Yes].

7. Press [ENTER] to execute.

7.26.2 Use Compound Key

1. Use the **control panel**, and press [ENTER] + [MENU] simultaneously to restore the initial value.
<Note> Before using the compound keys, please remove all VGA-IN devices.

7.27 Computer-related functions

Ensure that the USB cable is connected and the drivers are installed before using the computer-related functions. Refer to [Chapter 4 Installation and Connections](#) in this user manual

7.27.1 I would like to insert a photo in MS-Paint

1. Click [File/From Scanner or Camera] in MS-Paint as shown in the bottom left figure.

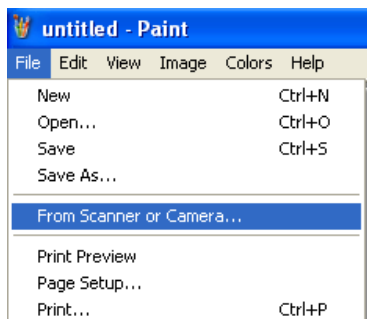

2. Click [Capture] to get the live images, as shown in the top right figure.
3. Click the image as shown in the right side of the top right figure.
4. Click [Get Picture]. It will capture the photo of live image.
<Remark> Support Windows XP Operation System only.

7.27.2 I would like to insert photos in Photoshop

1. Click [File/Read-in/WIA-USB Video Device] in **Photoshop**

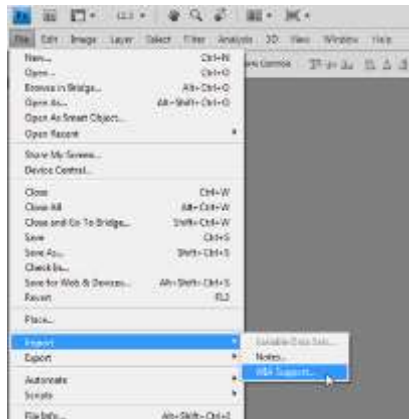

2. Click [Capture], and click the image as shown in the right side of the figure below. Then click [Get Picture].



Chapter 8 Connecting to Microscope

- 1 Mount the **microscope adapter** accessories onto the microscope
<Note> Please choose an appropriate microscope adapter. Microscope adapter accessories are applicable to eyepieces of $\text{Ø}28$ mm, $\text{Ø}31$ mm, $\text{Ø}33$ mm, and $\text{Ø}34$ mm.
- 2 The lens of DVP510 connects with the **microscope adapter**

For eyepieces of $\text{Ø}33$ mm or $\text{Ø}34$ mm, only fit one microscope adapter (with the greatest diameter).

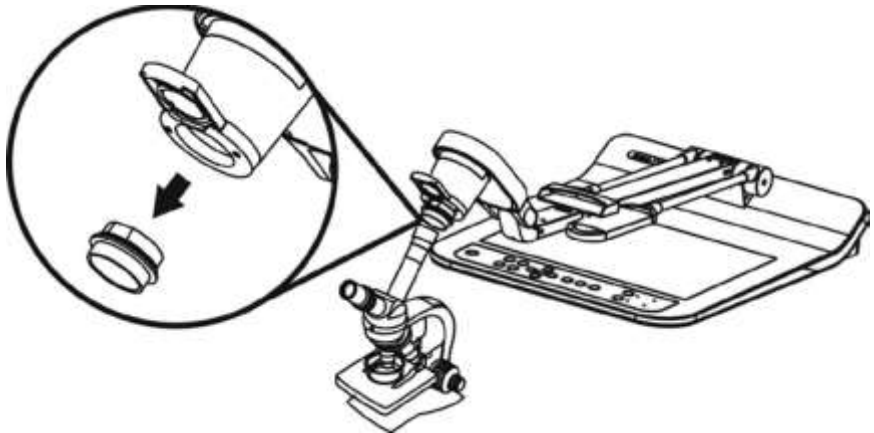

For eyepieces of $\text{Ø}28$ mm or $\text{Ø}31$ mm, fit one microscope adapter with the greatest diameter along with another appropriate one.

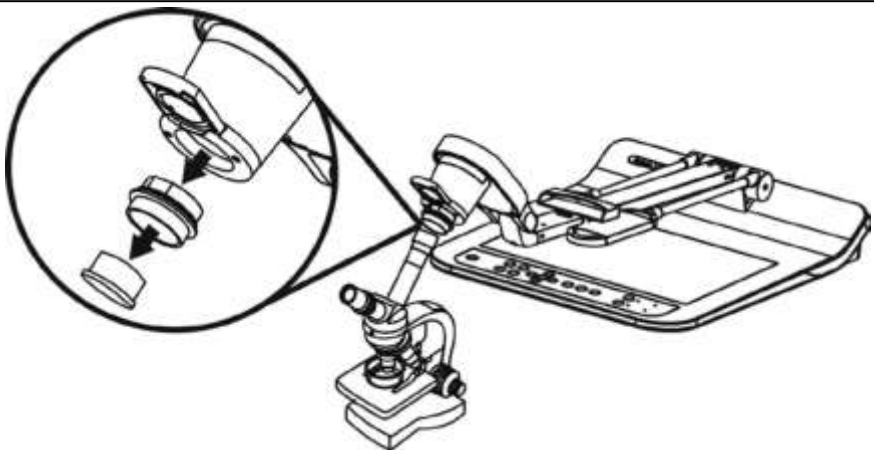

3 Select the **[Microscope]** mode

3.1. If you use the **remote control or the control panel**

- 3.1.1. Press [MENU] to enter the setting menu.
- 3.1.2. Press [▲], [▼], [▶], or [◀] to select [Image Mode].
- 3.1.3. Press [▶] or [◀] to the [Microscope].
- 3.1.4. Press [MENU] to exit.

4 If the image is not clear

- 4.1. Please adjust the focus of microscope
- 4.2. Press [AUTO TUNE] button on the **control panel** to activate the auto focus

5 Digital zoom

5.1. If you use the **remote control or the control panel**

- 5.1.1. Press [MENU] to enter the setting menu.
- 5.1.2. Press [▶] or [◀] to the [Control].
- 5.1.3. Press [▼] to select [Digital Zoom].
- 5.1.4. Press [▶] or [◀] to the [On].
- 5.1.5. Press [ZOOM +] / [ZOOM -].

<Note> Please reset to normal mode after using the microscope, otherwise, you are unable to use zoom in/out function.

1. Press [MENU] on the **remote control or control panel** to enter the setting menu.
2. Press [▲], [▼], [▶], or [◀] to select [Image Mode].
3. Press [▶] or [◀] to the [Normal].
4. Press [MENU] to exit.

Chapter 9 Packing the Machine

1. Put the remote control back to the holder.
2. Fold back the camera head to align with the arm.
3. Turn the two lamp arms and the arm of camera head down and adjust them to be parallel with the platform.
4. Put the lens cap on the camera head.
5. Finally, fold the machine as in the following figure.

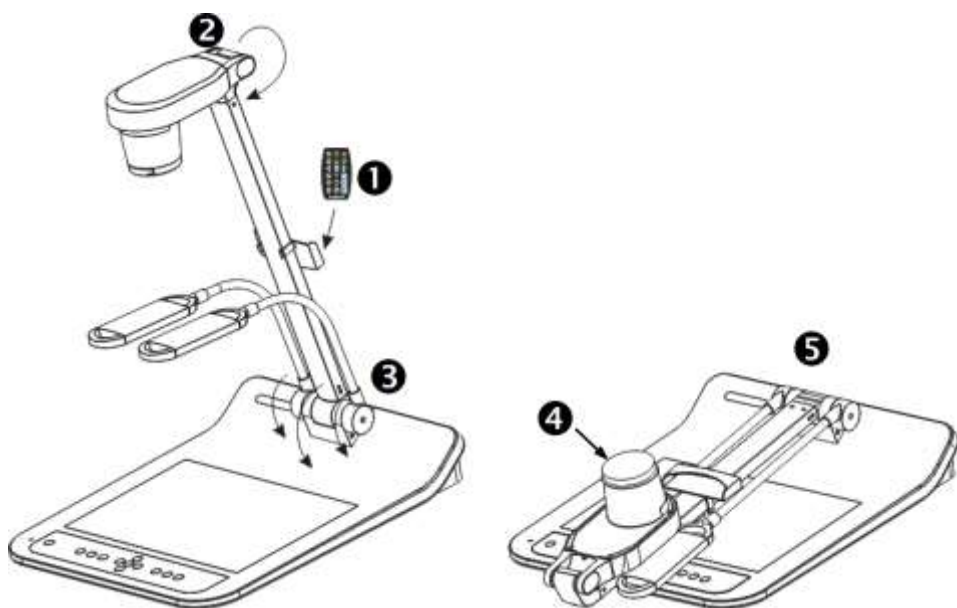

Chapter 10 DIP switch setting

<Note> You should unplug and reconnect the power cord, and then restart the DVP510 for all DIP switch settings to take effect.

10.1 Connecting to a projector or monitor

10.1.1 XGA 60 Hz output (default values) XGA 50 Hz output

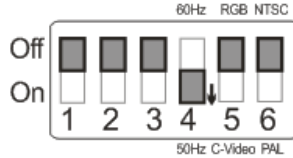
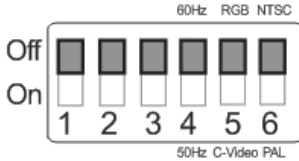

10.1.2 SXGA 60Hz output

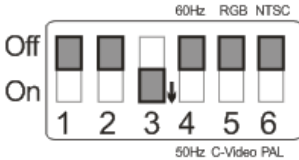

SXGA 50Hz output

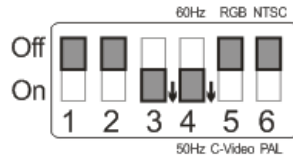

10.1.3 WXGA 60Hz output

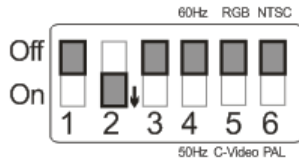

WXGA 50Hz output

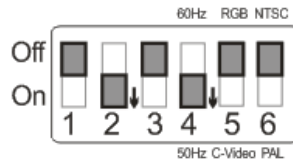

10.1.4 1080P 60Hz output

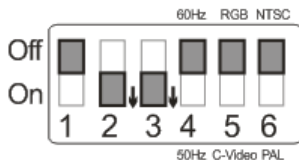

1080P 50Hz output

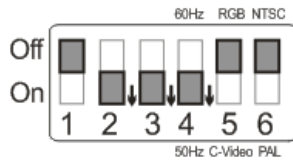

10.2 Connecting to a TV/DVD

10.2.1 NTSC: USA, Taiwan, Panama, Philippines, Canada, Chile, Japan, Korea, and Mexico.

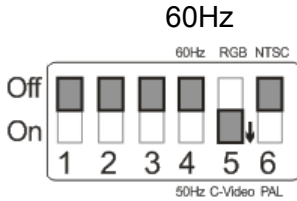

10.2.2 PAL: Countries/regions not listed above.

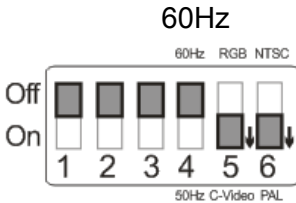

<Remark> VGA is not supported once C-VIDEO is enabled.

Chapter 11 Troubleshooting

This chapter describes problems you may encounter while using DVP510. If you have questions, please refer to related chapters and follow all the suggested solutions. If the problem still occurred, please contact our distributors or service center.

No.	Problems	Solutions
1	Boot without power signal	Make sure you have plugged in the power cord.
2	No image output from the DVP510	<ol style="list-style-type: none">1. Check the power.2. Check all cable connections. Refer to Chapter 4 Installation and Connections in this manual.3. Check the [Source], refer to 7.2 I would like to switch image sources of Chapter 7 Descriptions of Major Functions.4. Check the settings for the source of the projector. Please refer to the user manual of the projector.5. Check if DIP switch is properly set. Please refer to Chapter 10 DIP Switch Setting for related settings.
3	Unable to focus	Probably the document is too close. Press [ZOOM -] on the remote control or control panel . Or pull away the distance between document and lens, then press [AUTO TUNE] to activate auto focus.
4	The image is incomplete	Check the Auto Image setting of your projector. Please refer to the user manual of the projector or check for the DIP switch setting.
5	Dukane Document Camera, B-Works2 and other applications cannot be used simultaneously	Dukanes Document Camera, B-Works2 and other applications cannot be used simultaneously. Only one application can be executed at a time. Please close the currently running applications and then execute the application to be used.
6	When DVP510 is turned on, the auxiliary floodlight do not light	Please make sure the arm lamp is set to [Off]. For the switch-on or -off of arm lamp, please refer to 7.9 I would like to turn on/off the lamp of Chapter 7 Descriptions of Major Functions .
7	DVP510 fails to store images or react	<ol style="list-style-type: none">1. Check to see if the stored data have reached the maximum size of the USB disk (priority) or internal memory.2. Please make sure if the capture function is set to continuous mode or the time for capture is set to be

		long. For the related setting, please refer to 7.12 I would like to capture images of Chapter 7 Descriptions of Major Functions.
8	The images outputted from DVP510 are too bright, dark or vague.	Press [AUTO TUNE] button to automatically adjust the image to have the best brightness and focusing performance.
9	Unable to record images	<ol style="list-style-type: none"> 1. Check to see if the stored data have reached the maximum size of the USB disk. 2. The recording function is not supported in the internal memory. Please make sure that USB disk is inserted for image recording.
10	The operating steps in the manual are not applicable to the machine	<p>The operating steps in the manual may be not applicable to the machine due to improvement in functions. Check to see if the Firmware version of your machine is up-to-date.</p> <ol style="list-style-type: none"> 1 Please go to Dukane's official website to check whether the latest version is available for update. www.dukaneav.com 2 The steps to check the FW version are as below: <ol style="list-style-type: none"> 2.1 Press [MENU] on the remote control or control panel to activate the setting menu. 2.2 Press [▲], [▼], [▶], or [◀] to select [Setting]. 2.3 Press [ENTER] to activate. 2.4 Press [▶] or [◀] to select [Advanced] menu. 2.5 View [Firmware Version]. <p>If you are not sure whether it is the latest version, please consult your distributor for advice. http://www.dukaneav.com</p>
11	How to unlock the locked device	<ol style="list-style-type: none"> 1. Press [MENU] on the remote control or control panel to activate the setting menu. 2. Press [▲], [▼], [▶], or [◀] to select [Setting]. 3. Press [ENTER] to activate. 4. Press [▶] or [◀] to select [Advanced] menu. 5. Press [▼] to [Lock Down]. 6. Press [▶] or [◀] to select [Off] and cancel the password setting function.
12	After using the USB cable to connect to a computer, modify VGA OUT (1) to VGA IN.	After using the USB cable to connect to a computer, only Live Image output is available.

	VGA IN/HDMI IN image output is not available through USB	
13	The output image is not clear with water ripples	Please refer to the Appendix 1 in the manual to confirm the applicable voltage frequency, and reset it according to the instruction in Chapter 10 DIP Switch Setting .
14	The data in the USB flash drive cannot be read.	<ol style="list-style-type: none"> 1. The USB flash drive with the capacity of 4 G and above is recommended (up to 32 G supported) 2. Please make sure the file was saved at the specified path: \DCIM\100MEDIA. (E.g.: J: \DCIM\100MEDIA) 3. Please make sure the file is named appropriately, e.g. four English letters + four numbers. (E.g.: LUMN0001.JPG)

Appendix 1

Power frequency for each country in the world

Region or Country	Frequency	Region or Country	Frequency	Region or Country	Frequency
English		English		English	
Afghanistan	50	China	50	Guam	60
Algeria	50	Colombia	60	Grenada	50
Angola	50	Congo	50	Guatemala	60
Antiqua	50	Costa Rica	60	Guinea	50
Argentina	50	Cuba	60	Gayana	50
Australia	50	Cyprus	50	Haiti	60
Austria	50	Czechoslovakia	50	Hawaii	60
Azores	50	Dahomey	50	Honduras	60
Bahamas	60	Denmark	50	Hong Kong	50
Bahrain	60	Dominican	60	Hungary	50
Bangladesh	50	Dubai	50	Iceland	50
Babados	50	Ecuador	60	India	50
Belgium	50	Egypt	50	Indonesian	50
Bermuda	60	El Salvador	60	Iran	50
Bolivia	50	Equatorial Guinea	50	Iraq	50
Botswana	50	Ethiopia	50	Ireland	50
Brazil	50 60	Faeroe Island	50	Isle of Man	50
Bulgaria	50	Fiji	50	Israel	50
Burma	50	Finland	50	Italy	50
Burundi	50	France	50	Ivory Coast	50
Cambodia	50	French Guiana	50	Jamaica	50
Cameroon	50	Gabon	50	Japan	50 60
Canada	60	Gambia	50	Jordan	50
Canary Island	50	Germany	50	Kenya	50
Central Africa Rep.	50	Ghana	50	Korea	60
Ceylon	50	Gibraltar	50	Kuwait	50
Chad	50	Great Britain	50	Lebanon	50
Channel Island	50	Greece	50	Lesotho	50
Chile	50	Greenland	50	Liberia	60
Libya	50	Oman	50	Syria	50
Luxembourg	50	Pakistan	50	Tahiti	60
Macao	50	Panama	60	R.O.C. Taiwan	60
Madeiral	50	Paraguay	50	Tanzania	50
Majokca Island	50	Peru	60	Thailand	50
Malagasy	50	Philippines	60	Togo Rep.of	50
Malawi	50	Poland	50	Tonga	50
Malaysia	50	Portugal	"	Trinidad	60

Region or Country	Frequency	Region or Country	Frequency	Region or Country	Frequency
English		English		English	
Mali Rep.	50	Puerto Rico	60	Tobago	60
Malta	50	Qatar	50	Tunisia	50
Martinique	50	Rhodesia	50	Turkey	50
Mauritania	50	Romania	50	Uganda	50
Mauritius	50	Rwanda	50	USA.	60
Mexico	60	Saudi Arabia	50	USSR	50
Monaco	50	Scotland	50	United Kingdom	50
Montserrat	60	Senegal	50	Upper Volta	50
Morocco	50	Sierra Leone	50	Uruguay	50
Mozambique	50	Singapore	50	Venezuela	60
Nepal	50	Somalia	50	Viet-Nam	50
Netherlands	50	South Africa Rep.	50	Virgin Island	60
New Caledonia	50	Spain	50	Western Samoa	50
New Zealand	50	Sri Lanka	50	Yeman(Aden)	50
Nicaragua	60	Sudan	50	Yemen(Arab)	50
Niger	50	Surinam	60	Yugoslavia	50
Nigeria	50	Swaziland	50	Zaire Rep. of	50
Norway	50	Sweden	50	Zambia	50
Okinawa	60	Switzerland	50		

DUKANE

DUKANE CORP AV SERVICE DEPT

2900 Dukane Drive

St Charles, IL 60174

800-676-2487 / 630-762-4032

Fax 630-584-5156

avservice@dukane.com

www.dukaneav.com