

USB-2001-TC

USB-based Thermocouple Input

User's Guide

Trademark and Copyright Information

Measurement Computing Corporation, InstaCal, Universal Library, and the Measurement Computing logo are either trademarks or registered trademarks of Measurement Computing Corporation. Refer to the Copyrights & Trademarks section on mccdaq.com/legal for more information about Measurement Computing trademarks. Other product and company names mentioned herein are trademarks or trade names of their respective companies.

© 2014 Measurement Computing Corporation. All rights reserved. No part of this publication may be reproduced, stored in a retrieval system, or transmitted, in any form by any means, electronic, mechanical, by photocopying, recording, or otherwise without the prior written permission of Measurement Computing Corporation.

Notice

Measurement Computing Corporation does not authorize any Measurement Computing Corporation product for use in life support systems and/or devices without prior written consent from Measurement Computing Corporation. Life support devices/systems are devices or systems that, a) are intended for surgical implantation into the body, or b) support or sustain life and whose failure to perform can be reasonably expected to result in injury. Measurement Computing Corporation products are not designed with the components required, and are not subject to the testing required to ensure a level of reliability suitable for the treatment and diagnosis of people.

Table of Contents

Preface	
About this User's Guide	4
What you will learn from this user's guide	4
Conventions in this user's guide	4
Where to find more information	4
Chapter 1	
Introducing the USB-2001-TC	5
Functional block diagram	5
Chapter 2	
Installing the USB-2001-TC	6
Unpacking the USB-2001-TC	6
Installing the software	6
Installing the hardware	6
Chapter 3	
Functional Details	7
Components	7
Thermocouple input	7
USB connector	8
LED indicator	8
Analog input circuitry	8
Open-thermocouple detection (OTD)	8
Thermocouple measurement accuracy	9
Cold-junction temperature measurement accuracy	9
Mechanical drawings	9
Chapter 4	
Specifications	10
Channel configurations	10
Compatible thermocouples	11
Temperature accuracy	11
LED indicator	14
Power	14
Safety voltages	15
Bus interface	15
Mechanical	15
Environment	15
Declaration of Conformity	16

About this User's Guide

What you will learn from this user's guide

This user's guide describes the Measurement Computing USB-2001-TC data acquisition device and lists device specifications.

Conventions in this user's guide

For more information

Text presented in a box signifies additional information and helpful hints related to the subject matter you are reading.

Caution! Shaded caution statements present information to help you avoid injuring yourself and others, damaging your hardware, or losing your data.

bold text **Bold** text is used for the names of objects on a screen, such as buttons, text boxes, and check boxes.

italic text *Italic* text is used for the names of manuals and help topic titles, and to emphasize a word or phrase.

Where to find more information

Additional information about USB-2001-TC hardware is available on our website at www.mccdaq.com. You can also contact Measurement Computing Corporation with specific questions.

- Knowledgebase: kb.mccdaq.com
- Tech support form: www.mccdaq.com/support/support_form.aspx
- Email: techsupport@mccdaq.com
- Phone: 508-946-5100 and follow the instructions for reaching Tech Support

For international customers, contact your local distributor. Refer to the International Distributors section on our website at www.mccdaq.com/International.

Introducing the USB-2001-TC

The USB-2001-TC is a USB 2.0 full-speed device that provides one thermocouple input channel.

- Thermocouple types J, K, R, S, T, N, E, and B are supported. The thermocouple type is software programmable and stored on the device. A 20-bit ADC processes the data conversions.
- Thermocouple input ranges are ± 73.125 mV (calibrated) and ± 146.25 mV, (not calibrated). The ± 146.25 mV range is used for open thermocouple detection.
- The device has an integrated cold junction compensation (CJC) sensor for thermocouple measurements. An open thermocouple detection feature lets you detect a broken thermocouple.

The USB-2001-TC was tested for full compatibility with both USB 1.1 and USB 2.0 ports.

The USB-2001-TC is a standalone plug-and-play module which draws power from the USB cable. No external power is required.



Figure 1. USB-2001-TC

Functional block diagram

USB-2001-TC functions are illustrated in the block diagram shown here.

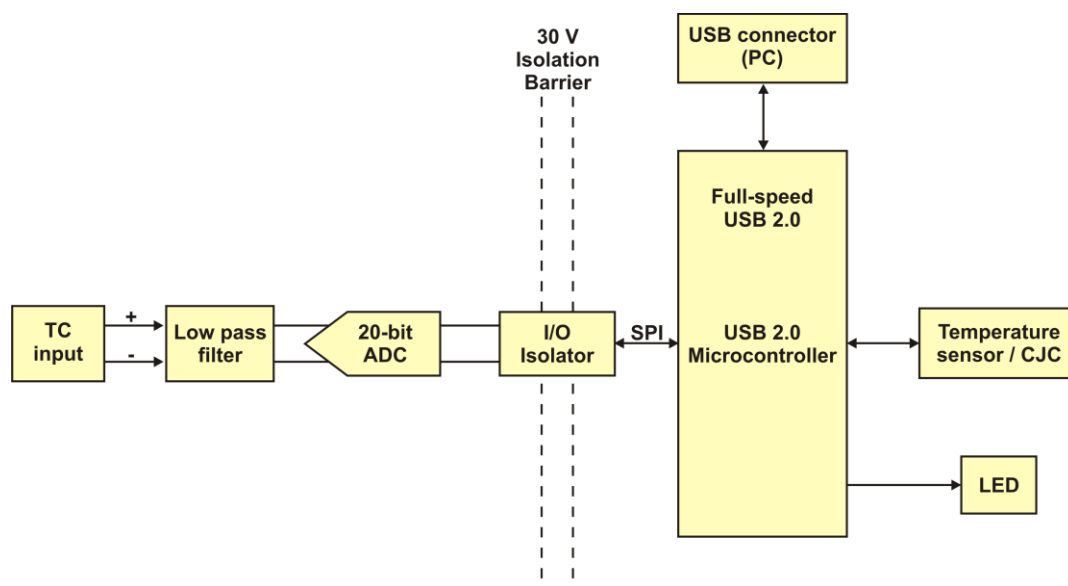

Figure 2. Functional block diagram

Installing the USB-2001-TC

Unpacking the USB-2001-TC

As with any electronic device, you should take care while handling to avoid damage from static electricity. Before removing the device from its packaging, ground yourself using a wrist strap or by simply touching the computer chassis or other grounded object to eliminate any stored static charge.

Contact us immediately if any components are missing or damaged.

Installing the software

Refer to the device product page on the Measurement Computing website for information about the included and optional software supported by the USB-2001-TC.

Install the software before you install your device

The driver needed to run the USB-2001-TC is installed with the software. Therefore, you need to install the software package you plan to use before you install the hardware.

Installing the hardware

To connect the USB-2001-TC to your system, connect a USB cable from the **USB** connector to either a USB port on the computer or to an external USB hub connected to the computer. No external power is required.

If the LED turns off

If the LED is on but then turns off, the computer has lost communication with the USB-2001-TC. To restore communication, disconnect the USB cable from the computer, and then reconnect it. This should restore communication, and the LED should turn on.

Functional Details

Components

The USB-2001-TC has the following components:

- Thermocouple input
- USB cable and connector
- LED indicator

Thermocouple input

You can connect one thermocouple to a standard thermocouple subminiature connector. Thermocouple types J, K, R, S, T, N, E, and B are supported. The thermocouple type you select will depend on your application needs. Review the temperature ranges and accuracies of each type to determine which thermocouple is best suited for the application.

Connect the positive lead of the thermocouple to the TC+ terminal, and the negative lead of the thermocouple to the TC- terminal.

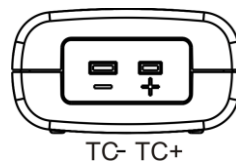

Figure 3. TC input terminals

If you are unsure which of the thermocouple leads is positive and which is negative, check the thermocouple documentation or the thermocouple wire spool.

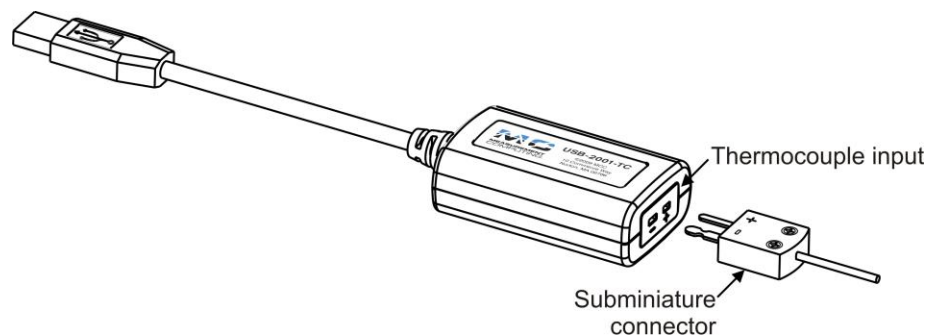

Figure 4. Connecting a thermocouple

For best results, use insulated or ungrounded thermocouples when possible. If you need to increase the length of your thermocouple, use the same type of thermocouple wires to minimize the error introduced by thermal EMFs.

Temperature measurement errors depend in part on the thermocouple type, the temperature being measured, the accuracy of the thermocouple, and the cold-junction temperature.

Thermocouple with bare wire leads

If your thermocouple has bare wire leads, you can purchase a screw terminal subminiature connector to use with the USB-2001-TC. These are available from a number of suppliers, such as Nanmac Corporation (www.nanmac.com). For the best accuracy, the subminiature connector type and thermocouple type should match.

Figure 5 shows the screw terminal connector wiring.

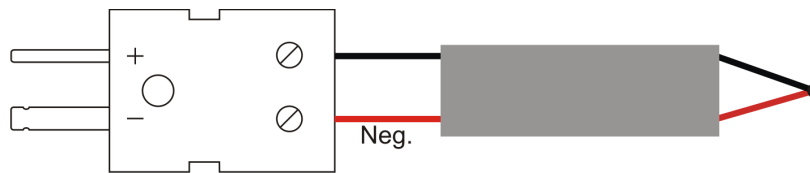

Figure 5. Screw terminal connector wiring

USB connector

The USB connector provides +5 V power and communication. The voltage supplied through the USB connector is system-dependent, and may be less than 5 V. No external power supply is required.

LED indicator

The device LED indicates the communication status, and uses up to 5 mA of current.

LED behavior

Condition	Specification
On – steady green	The device is powered and ready for operation.
On – blinking green	The device is powered, but not yet enumerated by the USB.
Off	The device is not powered or is in USB suspend.

Analog input circuitry

Figure 6 shows the analog input circuitry. The thermocouple channel passes through a differential filter and is sampled by a 20-bit analog-to-digital converter (ADC).

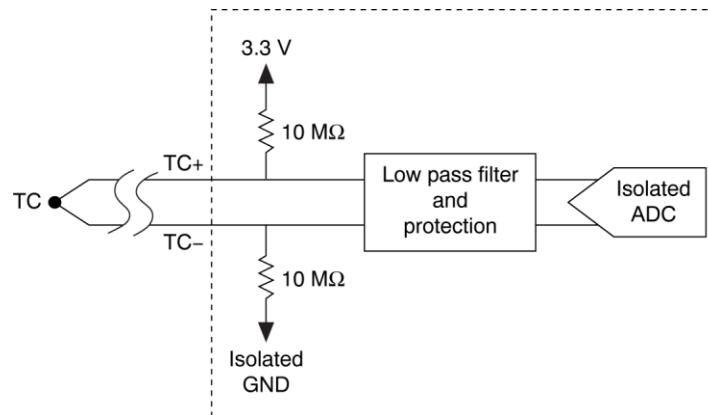

Figure 6. Analog input circuitry

Open-thermocouple detection (OTD)

The USB-2001-TC is equipped with open-thermocouple detection. With OTD, any open-circuit condition at the thermocouple sensor is detected by the software. An open channel is detected by driving the input voltage to a positive value outside the range of the thermocouple output. The software recognizes this as an invalid reading and returns the value "OTD". During an open thermocouple condition, some invalid values may be returned before the open thermocouple is reported.

Check the STATUS value before reading temperature values

To ensure that valid temperature readings are returned, verify that the value of **STATUS** is **READY** before taking measurements. Invalid temperature readings may be returned if the **STATUS** value is **BUSY** or **ERROR**. A value of **BUSY** indicates that no new data is available. In this condition the same temperature value as previously read is returned until the **STATUS** value changes to **READY**.

Thermocouple measurement accuracy

Cold-junction temperature measurement accuracy

Heat from other nearby heat sources can cause errors in thermocouple measurements by heating up the terminals so that they are at a different temperature than the cold-junction compensation sensor used to measure the cold junction.

Minimizing thermal gradients

Thermocouple wire can be a significant source of thermal gradients if it conducts heat or cold directly to terminal junctions. To minimize these errors, follow these guidelines:

- Use small-gauge thermocouple wire. Smaller wire transfers less heat to or from the measuring junction.
- Avoid running thermocouple wires near hot or cold objects.

Increasing the thermocouple length

If you need to increase the length of your thermocouple, use wires made of the same conductive material to minimize the error introduced by thermal EMFs.

Mechanical drawings

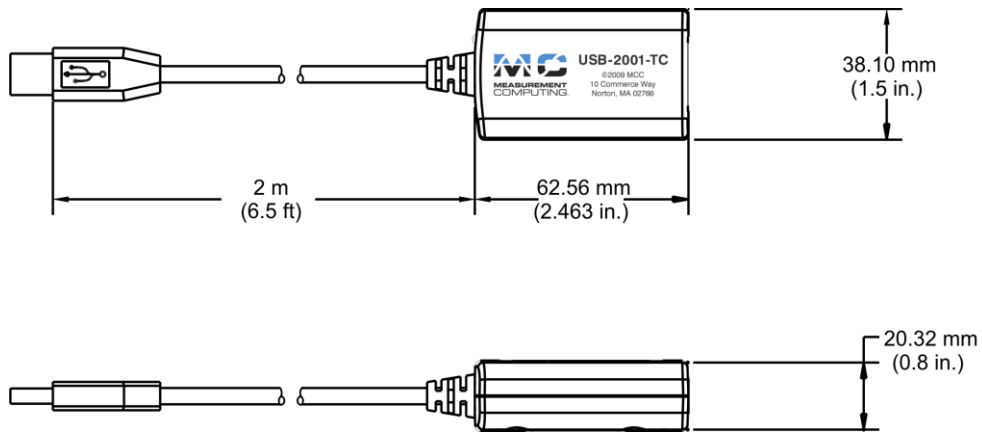

Figure 7. USB-2001-TC dimensions

Specifications

All specifications are subject to change without notice.

Typical for 25 °C unless otherwise specified.

Caution! Electromagnetic interference can adversely affect the measurement accuracy of this product. The input terminals of this device are not protected for electromagnetic interference. As a result, this device may experience reduced measurement accuracy or other temporary performance degradation when connected cables are routed in an environment with radiated or conducted radio frequency electromagnetic interference. To limit radiated emissions and to ensure that this device functions within specifications in its operational electromagnetic environment, take precautions when designing, selecting, and installing measurement probes and cables.

Analog input

Table 1. Input characteristics

Parameter	Conditions	Specification
Number of channels		One
ADC resolution		20 bits
Input ranges		±73.125 mV, calibrated ±146.25 mV, not calibrated. Used for open thermocouple detection.
Common-mode range	Channel-to-USB ground	±30 V
Common-mode rejection ratio (0 to 60 Hz)	Channel-to-USB ground	>145 dB
Noise rejection	50/60 Hz	>80 dB
Temperature measurement ranges		Works over temperature ranges defined by NIST (J, K, R, S, T, N, E, and B thermocouple types.) The E type has a maximum limit of 900 °C.
Conversion time		250 ms
Input bandwidth	-3 dB	1 Hz
Differential input impedance		20 MΩ between isolated 3.3 V and ground
Input noise		2 μV _{pp}
Open thermocouple bias voltage		3.3 V
Cold-junction compensation sensor accuracy	0 to 65 °C	1.25 °C maximum, 0.6 °C typical
Cold-junction compensation sensor resolution		0.0625 °C typical
Overvoltage protection		30 V max between TC+ and TC-

Channel configurations

Table 2. Channel configuration specifications

Sensor category	Conditions	Specification
Thermocouple (Note 2)	J, K, S, R, B, E, T, or N	One differential channel

Note 1: Channel configuration information is stored in internal FLASH Program Memory on the microcontroller by the firmware whenever any item is modified. Modification is performed by commands issued over USB from an external application, and the configuration is non-volatile.

Note 2: The factory default configuration is *undefined* '#'.

Compatible thermocouples

Table 3. Compatible sensor type specifications

Parameter	Specification
Thermocouple type	J: -210 °C to 1200 °C
	K: -270 °C to 1372 °C
	R: -50 °C to 1768 °C
	S: -50 °C to 1768 °C
	T: -270 °C to 400 °C
	N: -270 °C to 1300 °C
	E: -270 °C to 900 °C
	B: 0 °C to 1820 °C

Temperature accuracy

The following graphs show the errors for each thermocouple type when connected to the USB-2001-TC. The graphs display the maximum errors at 25 °C and over the full operating temperature range, and account for cold-junction compensation errors. The graphs were generated using thermocouples connected to subminiature connectors of the same type.

The CJC sensor resolution is 0.0625 °C. This is the minimum value of the CJC step width. As such, the reading may result in a saw tooth curve rather than a square curve as the temperature inside the board changes. This is the expected behavior.

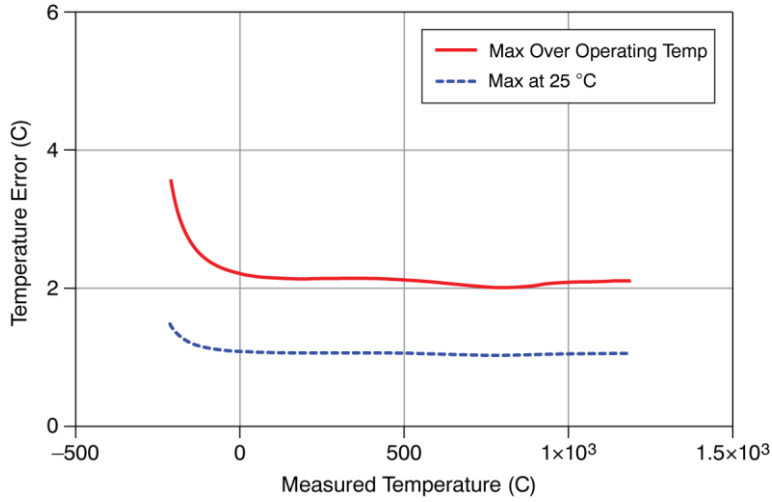

Temperature error of J type thermocouple

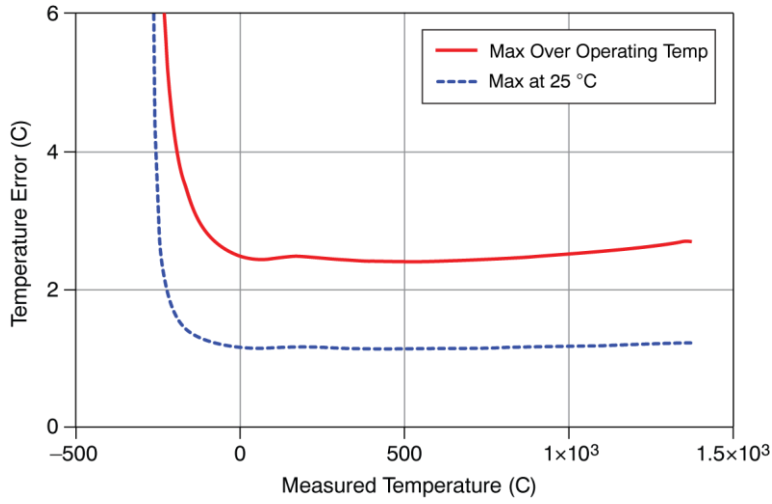

Temperature error of K type thermocouple

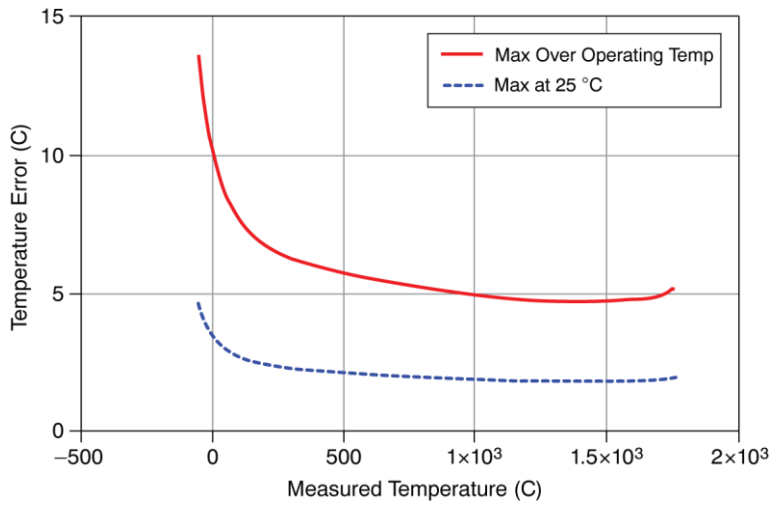

Temperature error of R type thermocouple

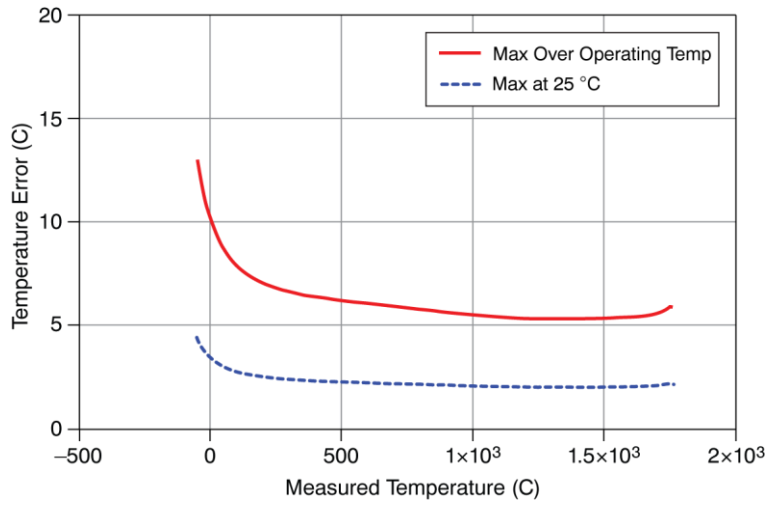

Temperature error of S type thermocouple

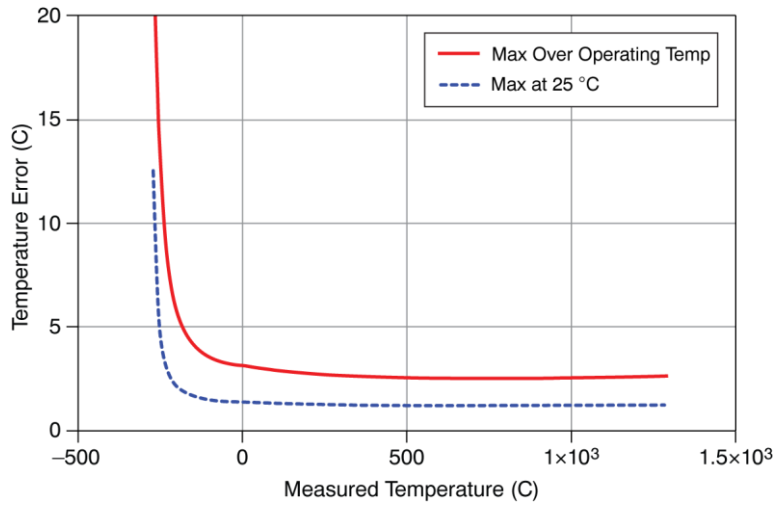

Temperature error of N type thermocouple

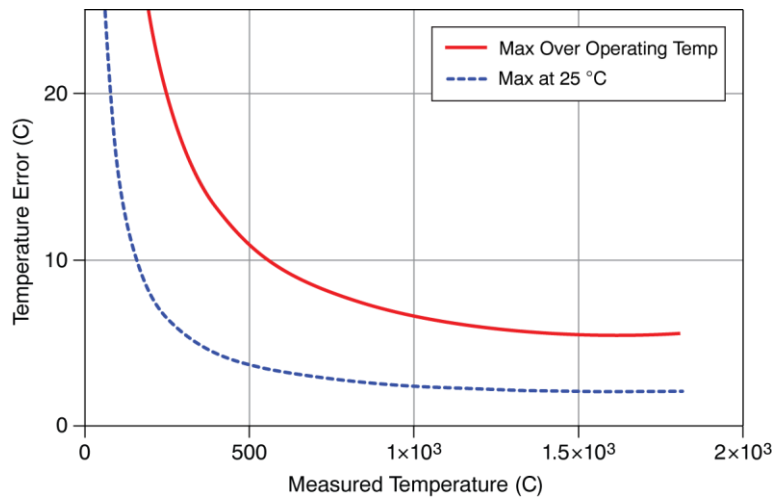

Temperature error of B type thermocouple

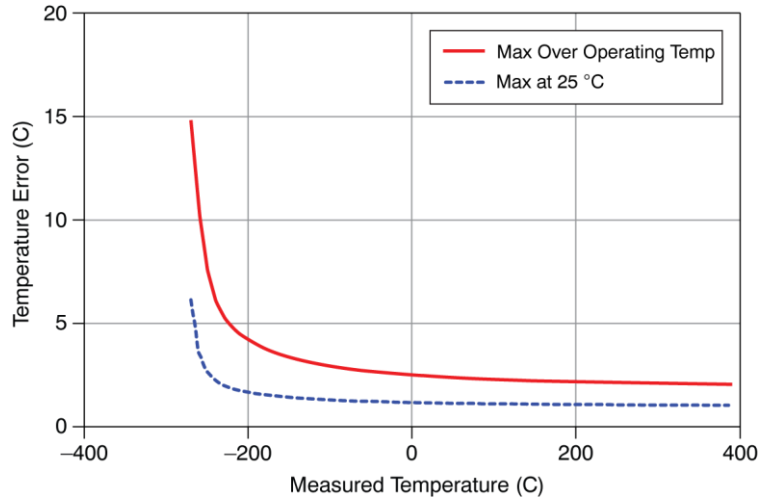

Temperature error of T type thermocouple

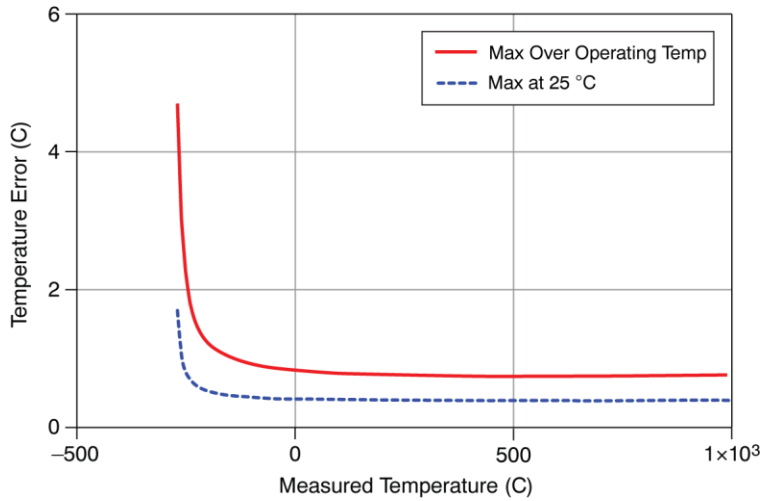

Temperature error of E type thermocouple

LED indicator

Table 4. LED behavior

Condition	Specification
Steady green	The device is powered and ready for operation.
Blinking green	The device is powered, but not yet enumerated by the USB.
Off	The device is not powered or is in USB suspend.

Power

Table 5. Power specifications

Parameter	Specification
Current consumption from USB	150 mA maximum, 100 mA typical
Suspend current	2.5 mA maximum
Recommended warm-up time	15 minutes

Safety voltages

Connect only voltages that are within these limits.

Table 6. Safety voltage specifications

Parameter	Conditions	Specification
Isolation	Channel-to-earth ground	+30 V maximum (Note 3)

Note 3: Measurement Category I is for measurements performed on circuits *not* directly connected to the electrical distribution system referred to as *MAINS* voltage. *MAINS* is a hazardous live electrical supply system that powers equipment. This category is for measurements of voltages from specially protected secondary circuits. Such voltage measurements include signal levels, special equipment, limited-energy parts of equipment, circuits powered by regulated low-voltage sources, and electronics.

Bus interface

Table 7. Bus specifications

Parameter	Specification
USB specification	USB 2.0 Full-Speed
Device compatibility	USB 1.1, USB 2.0

Mechanical

Table 8. Mechanical specifications

Parameter	Specification
Dimensions	62.56 mm (L) x 38.10 mm (W) x 20.32 mm (H) 2.46 in. (L) x 1.50 in. (W) x 0.80 in. (H)
Cable Length	2 meters (6.5 feet)
Weight	Approximately 116 g (4.1 oz)

Environment

Table 9. Environmental specifications

Operating temperature range	0 to 55 °C
Storage temperature range	-40 to 85 °C
Operating humidity	10 to 90% non-condensing
Storage humidity	5 to 95% RH, noncondensing
Maximum altitude	2,000 m (at 25 °C ambient temperature)
Pollution degree	2

Note 4: The USB-2001-TC is intended for indoor use only.

CE Declaration of Conformity

Manufacturer: Measurement Computing Corporation
Address: 10 Commerce Way
Suite 1008
Norton, MA 02766
USA

Category: Electrical equipment for measurement, control and laboratory use.

Measurement Computing Corporation declares under sole responsibility that the product

USB-2001-TC

to which this declaration relates is in conformity with the relevant provisions of the following standards or other documents:

EC EMC Directive 2004/108/EC: General Requirements, EN 61326-1:2006 (IEC 61326-1:2005).

Emissions:

- EN 55011 (2007) / CISPR 11(2003): Radiated emissions: Group 1, Class A
- EN 55011 (2007) / CISPR 11(2003): Conducted emissions: Group 1, Class A

Immunity: EN 61326-2-1:2006, Particular requirements for sensitive test and measurement equipment for EMC unprotected applications.

- IEC 61000-4-2 (2001): Electrostatic Discharge immunity.
- IEC 61000-4-3 (2002): Radiated Electromagnetic Field immunity.
- IEC 61000-4-4 (2004): Electric Fast Transient Burst Immunity.
- IEC 61000-4-5 (2001): Surge Immunity.
- IEC 61000-4-6 (2003): Radio Frequency Common Mode Immunity.
- IEC 61000-4-11 (2004): Voltage Interrupts.

To maintain compliance to the standards of this declaration, the following conditions must be met.

- The host computer, peripheral equipment, power sources, and expansion hardware must be CE compliant.
- All I/O cables must be shielded, with the shields connected to ground.
- I/O cables must be less than 3 meters (9.75 feet) in length.
- The host computer must be properly grounded.

Declaration of Conformity based on tests conducted by National Instruments Corporation, Austin, TX , 78759-3504 USA in November, 2009.

We hereby declare that the equipment specified conforms to the above Directives and Standards.



Carl Haapaoja, Director of Quality Assurance

Measurement Computing Corporation
10 Commerce Way
Suite 1008
Norton, Massachusetts 02766
(508) 946-5100
Fax: (508) 946-9500
E-mail: info@mccdaq.com
www.mccdaq.com