

Cerebot MC7™ Board Reference Manual

Revised October 23, 2012

This manual applies to the Cerebot MC7 rev. F

Overview

The Cerebot MC7 board is microcontroller development board based on a Microchip[®] dsPIC 16-bit Digital Signal Controller.

The Cerebot MC7 is primarily intended to be used as a controller for electro-mechanical devices such as DC motors. The microcontroller used, a dsPIC33FJ128MC706A, is a member of a dsPIC family optimized for motor control applications.

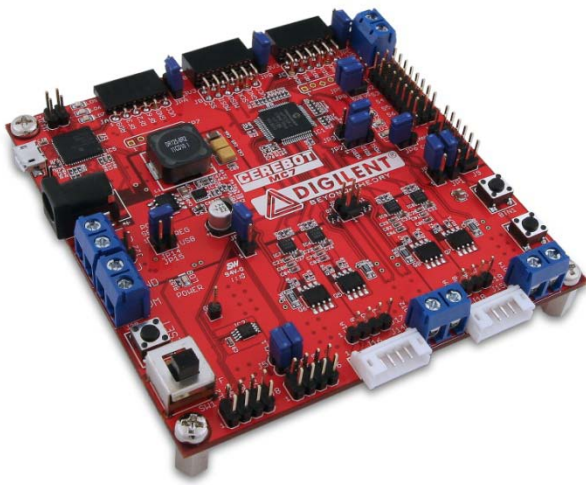

The Cerebot MC7 board.

Features include:

- A dsPIC33FJ128MC706A microcontroller
- Four 24V/5A Half Bridge circuits with current and voltage feedback and provision for over-current interrupt
- Power supply voltage up to 24V
- 5V/4A switching power supply
- Integrated programming/debugging circuit
- One CAN network interface
- Three Pmod connectors for Digiilent peripheral module boards
- Eight RC servo connectors
- two I2C daisy chain connectors
- 256Kbit I2C EEPROM
- Two push buttons and four LEDs
- ESD protection and short circuit protection for all I/O pins.

The Cerebot MC7 provides four Half-Bridge circuits that are rated for 24V at up to 5A. Each of these Half Bridge circuits is connected to the dsPIC A/D converter to measure voltage and current for closed loop feedback control. These half bridges can be used to control two brushed DC motors, two bi-polar stepper motors, one brushless DC motor, one uni-polar stepper motor. In addition, the board can be used to implement controllers for switched DC-DC converters.

The Cerebot MC7 works with the Microchip MPLAB[®] development environment and provides built in programming and debugging support within the MPLAB IDE.

Features of the dsPIC33FJ128MC706A include:

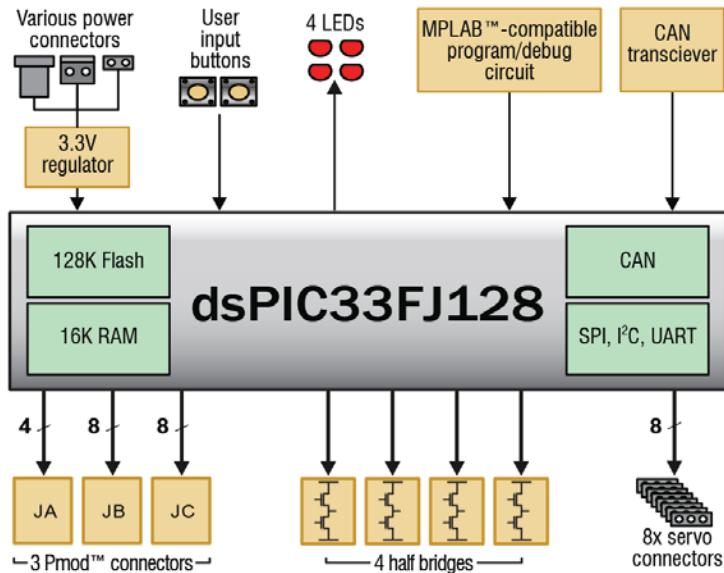

Cerebot MC7 circuit diagram.

- 128KB internal program flash memory
- 16KB internal SRAM memory
- two 40-bit accumulators for DSP MAC operation
- eight channel hardware DMA
- Advanced 8-channel motor control PWM unit
- enhanced CAN controller
- eight 16-bit timer/counters
- eight output compare/PWM units
- eight input capture units
- two UART serial interfaces
- two serial peripheral interfaces (SPI)
- two I2C serial interfaces
- sixteen 10-bit analog inputs
- two analog to digital converters capable of 10-bit at 1.1Msps or 12-bit at 500Ksps

For more information on the dsPIC33FJXXXMCX06A/X08A/X10A data sheet and the dsPIC33 family reference manual available from the Microchip website, www.microchip.com.

1 Functional Description

The Cerebot MC7 is designed for use in embedded motor control applications as well as general microprocessor experimentation. Firmware suitable for many applications can be downloaded to the Cerebot MC7's programmable dsPIC33 microcontroller using the on-board programmer/debugger circuit.

Refer to the Cerebot MC7 schematic diagram available from the Digiilent web site (www.digilentinc.com) for detailed information about the arrangement of the various circuit features on the board.

The board provides four independent half bridge circuits capable of up to 5A continuous current. These half bridges are connected to the Motor Control PWM Module in the dsPIC microcontroller and can be used individually or in various combinations to drive various external loads, such as brushed DC motors, brushless DC motors, stepper motors, and so on.

A switching 5V, 4A regulator with input voltage up to 24V is provided on the board to simplify operation of the board from a single power supply in embedded application, such as robots.

The board has a variety of input/output connection options, and is specially designed to work with the Digiilent line of Pmod peripheral modules with various input and output functions. For more information, see www.digilentinc.com. In addition to the Pmod connectors, the board provides two push buttons and four LEDs for user i/o, as well as providing connections for two I2C busses. A serial EEPROM is provided on one of the I2C busses.

The Cerebot MC7 can be used with the Microchip MPLAB development environment. In-system-programming and debugging of firmware running on the dsPIC33 microcontroller is supported using an on-board program/debug circuit licensed from Microchip.

The Cerebot MC7 features a flexible power supply system with a number of options for powering the board as well as powering peripheral devices connected to the board. It can be USB powered via the debug USB port, or it can be powered from an external power supply or batteries.

2 Programming and Debugging Using MPLAB IDE

The Cerebot MC7 board is intended to be used with the Microchip MPLAB® IDE and the Microchip C30 C compiler for dsPIC for firmware development, programming and in-system debugging.

In system programming and debuggin is accomplished using a programmer/debugger circuit licensed from Microchip. Either MPLAB version 8.63 or later or MPLAB-X is required for its operation. The licensed debugger is accessed via USB, using connector J13. This connector is a micro-USB connector on the upper left corner of the board. The provided USB cable should be connected from J13 to a USB port on the development PC for access to the board.

When creating a new project, use the Configure.Select Device menu to specify the dsPIC device in use. Ensure that the device is set to dsPIC33FJ128MC706A.

To use the on-board programming/debugging circuit it must be selected as the debugger or programmer. Use the Debugger.Select Tool menu, or the Programmer.Select Tool menu, and select “Licensed Debugger” as the programmer or debugger.

The dsPIC microcontroller used on the Cerebot MC7 uses a two wire interface for in-system programming and debugging. There are three alternative pairs of pins that can be used for this purpose. The Cerebot MC7 is designed to use signal pair 1, PGEC1/PGED1, for the connection to the licensed debug circuit. This selection is controlled by configuration bits programmed when a firmware image is programmed into the board. This is selected using configuration macros provided with the Microchip C30 compiler. A statement similar to this should appear in the main program module of the project:

```
/* Use PGC1/PGD1 for programming and debugging
*/
_FICD(ICS_PGD1 & JTAGEN_OFF);
```

Refer to the dsPIC device data sheet, the appropriate section of the dsPIC33F Family Reference Manual and the C30 compiler documentation for more information.

3 Board Power Supply

Switch SW1, in the lower left corner of the board is the power switch. Place this switch in the ON position to turn on board power and in the OFF position to turn off board power.

The Cerebot MC7 board has three power supplies. One power supply is used to regulate power for the main circuitry on the Cerebot MC7 board. This supply provides power to the 5V peripherals on the board, such as the

CAN transceiver and provides the regulated 3.3V to power the microcontroller and most of the peripherals on the board. This supply requires a regulated 5V input.

A second power supply is used to provide an independent supply for the licensed debugger circuit. This provides power to the debug circuit as soon as the power switch is turned on. This power supply uses a Microchip MCP1801 low dropout regulator.

The USB specification requires that USB devices not draw more than 100mA of current until they have enumerated on the USB bus and requested more current from the host. To meet this specification, the debug circuit turns on main board power by driving the PWR_ON signal high after successfully enumerating on the USB bus. The bus labeled on the schematic as BRD5V0 is switched on when this occurs. The BRD5V0 bus powers the input to the primary voltage regulator, the power supply voltage for the CAN transceiver, and the 5V0 side of the power select jumpers for the Pmod connectors.

The third power supply is a 5V switching voltage regulator that can produce 5V at 4A from an external source between 5V and 24V. This power supply can be used to supply the regulated 5V input to the main board power supply, and also can provide 5V power to power hobby servos connected to the servo connectors. This switching regulator allows single supply operation of the Cerebot MC7 board from an external power supply or battery at up to 24V DC.

There are two power options for main power to the board: from an external power source via the on-board 5V switching regulator or USB powered from the debug USB connector, J13. To power the board from an external power supply, place a shorting block on JP14 (labeled REG). To select USB power from the USB debug connector, place a shorting block on JP15 (labeled USB). Note that the dsPIC and other circuitry on the board, plus connected Pmods and I²C devices can be powered from the USB connector. External loads such as motors and hobby servos cannot be powered from the USB connector.

NOTE: A shorting block should be installed on either JP14 or JP15, but never both at the same time. If shorting blocks are installed on both at the same time, 5V from the on-board switching regulator could back-feed to the USB port, potentially damaging the USB port of the PC or USB hub.

When powering the board from an external power supply, there are three power supply connectors that can be used: J21, J22 and J24.

Connector J21 is a screw terminal connector providing an alternative power supply connection for use with battery packs, bench supplies or other power sources where use of a hard wired power supply is desirable.

Connector J22 is a two pin header connector that can be used with some battery packs or other wired connections. This connector is rated for a maximum input current of 2A.

The barrel connector, J24, is used to power the board from a “wall wart” style power supply. This type of power supply is available from many sources. Digiilent has an optional power supply available, the 5V Switching Power Supply, that can be used with connector J17. Connector J17 is a 2.5mm x 5.5mm coaxial connector wired with the center terminal as the positive voltage.

Connectors J21, J22, and J24 are wired in parallel and connect directly to the input of the switching 5V regulator.

NOTE: The dropout of the switching 5V regulator is approximately 100mV when operated from a 5V input. This allows operation of the board from an external 5V supply.

The dsPIC microcontroller and on-board I/O devices operate at a supply voltage of 3.3V provided by the BRD3V3 bus. The regulated voltage on this bus is provided by a Microchip MCP1725 Low Dropout voltage regulator, IC22.

This regulator is capable of providing a maximum of 500mA of current. The DSPIC33 microcontroller will use approximately 90mA when running at 40 MIPS. The other circuitry on the board will draw 10-20 mA. The remaining current is available to provide power to attached Pmods and I²C devices. The voltage regulator is on the bottom of the board, below Pmod connector JA, and will get warm when the amount of current being used is close to its limit.

The Cerebot MC7 can provide power to any peripheral modules attached to the Pmod connectors, JA-JC, and to I²C devices powered from the I²C daisy chain connectors, J6 and J8. Each Pmod connector provides power pins that can be powered from either the switched main power bus, BRD5V0, or regulated voltage, BRD3V3, by setting the voltage jumper block to the desired position. The I²C power connectors only provide regulated voltage, BRD3V3.

4 Half-Bridge Circuits

The Cerebot MC7 circuit provides four half bridges. A half bridge is made up of two stacked transistors such that the high side transistor can source current from the motor power supply and the low side transistor can sink current to the supply ground.

Each half bridge is made up of an On Semiconductor NTMD4820N dual N-FET to provide the transistors and a Microchip MCP14700MF FET driver. The FET driver provides a high side transistor drive input and a low side transistor drive input.

The NTMD4820N FETs are rated for a maximum V_{DS} of 30V, maximum V_{GS} of 20V, and maximum drain current (I_D) of 8A at 25°C, 6.4A at 70°C ($t < 10s$) or 6.4A continuous drain current at 25°C and 5.1A at 70°C. For more detailed information on the NTMD4820N, refer to the device data sheet available at the On Semiconductor web site.

The steady state temperature of the FETs with all four half bridges switching at 50% duty cycle and a load current of 5A each has been measured to be ~55°C. Operation in some applications may require heat sinking or fan cooling of the board to maintain continuous operation at the full 5A output current.

The high side and low side drive inputs for each half bridge are connected to PWMH and PWML outputs from the Motor Control PWM module in the dsPIC microcontroller. The Motor Control PWM module is an advanced pulse width modulation generator optimized for motor control applications. This PWM unit provides eight outputs arranged as four high and low side drive pairs for controlling four half bridge circuits.

The half bridges can be operated independently, in pairs to form two h-bridges, or in other combinations using the Motor Control PWM module.

Connector J20 is used to provide the power supply voltage for the high side of the half bridges, and therefore powers whatever external load is being controlled by the board. This is a screw terminal connector on the left side of the board. A power supply or battery of 5V-24V can be used, with a maximum continuous current of 10A.

The half bridge connections between the bridge output signals and the Motor Control PWM module are configured in the following way:

VMOT1	PWM1H, PWM1L
VMOT2	PWM2H, PWM2L
VMOT3	PWM3H, PWM3L
VMOT4	PWM4H, PWM4L

These outputs from the bridges are available on connectors J14 & J15 or J16 & J18. Connectors J14 & J15 are screw terminal connectors for wire attachment. Connectors J16 & J18 are 6-pin JST connectors used by the gear head motors available from Digilent.

Connectors J14 & J16 provide the outputs VMOT1 and VMOT2, while J15 & J18 provide the outputs VMOT3 and VMOT4.

5 Current and Voltage Feedback

Each of the four half bridges is configured for monitoring the current flow through the low side transistor of the bridge. A voltage proportional to the bridge current is applied to one of the A/D inputs on the dsPIC microcontroller for each half bridge.

A 10 milli-ohm (0.01 ohm), 1% current sense resistor is connected between the source of each low side FET and ground. A differential amplifier with a fixed gain of 21 and an offset voltage of 1.0V is used to buffer and amplify the voltage across the current sense resistors before being applied to the inputs to the A/D converter. The following formula relates the voltage applied to the A/D converter input to the sensed bridge current:

$$V = (0.21 * I) + 1.0$$

Refer to Appendix C for tables showing data measured from an example board.

In addition to the bridge current, the output voltage of each half bridge can be monitored as well. The output voltage of each half bridge can be connected via a voltage divider to one of the inputs to the A/D converter. The voltage divider ratio is as follows:

$$V_o = 2.2/17.2 * V_i = 0.128 * V_i$$

The voltage monitoring can be enabled/disabled via jumpers JP9-JP12.

The current/voltage monitoring signals are connected to the A/D converter inputs in the following way:

IMON1	AN0
IMON2	AN1
IMON3	AN2
IMON4	AN3

VMON1	AN10
VMON2	AN11
VMON3	AN12
VMON4	AN13

6 Over-current Detection

The Cerebot MC7 provides an over-current monitoring mechanism for detecting excessive current flow through any of the half bridge circuits.

Four comparators are used to monitor the current measurement from each half bridge compared to a fixed reference voltage. The outputs of these comparators are OR'd together and applied to external interrupt INT1 on the dsPIC microcontroller.

A fixed reference voltage of 2.33V is used to set the comparator threshold for determining an over current condition. This sets the comparator to signal an over-current condition at 6A. If the current through any half bridge exceeds ~6A, an interrupt can be triggered on INT1.

7 CAN Interface

The Controller Area Network (CAN) standard is a control networking standard originally developed for use in automobile systems, but has since become a standard used in various industrial control and building automation networking applications as well.

The dsPIC33 microcontroller used on the Cerebot MC7 contains a CAN network controller. This CAN controller in combination with a Microchip MCP2551 CAN transceiver allow the Cerebot MC7 board to operate on a CAN network. Refer to the dsPIC33FJXXMCMC06A/X08A/X10A Data Sheet and the dsPIC33F Family Reference Manual, plus CAN network documentation for information on operation of the CAN controllers and CAN networking in general.

There is no standard connector for use with CAN networks. The Cerebot MC7 board provides a 2x6 pin header connector, J9, for access to the CAN signals. Refer to the schematic for the Cerebot MC7 board for information on the connectors and signals. Digiilent 6-pin or 2x6 to dual 6-pin cables can be used to daisy chain Digiilent boards together in a CAN network. A Digiilent 6-Pin cable in combination with a Digiilent PmodCON1 Screw Terminal Connector module can be used to connect the Cerebot MC7 board to other network wiring configurations.

The CAN network standard requires that the network nodes at each end of a network provide 120 ohm termination. The Cerebot MC7 provides the termination resistor and jumpers to enable/disable this resistor depending on the location of the board in the network. Jumper JP6 is used to enable/disable the termination resistor. Install a shorting block on the jumper pins to enable the termination resistor, or remove the shorting block to disable the termination resistor.

8 RC Servo Connectors

The Cerebot MC7 provides eight 3-pin RC hobby servo connectors for direct control of servos in robotics and embedded hardware actuator applications. These connectors are on the upper right side of the board.

The servo connectors S1-S8 are connected to PORTD bits 0-7 in the dsPIC33F microcontroller. These signals also appear on Pmod connector JC, and PORTD bits 4-7 are also used by the on-board LEDs. Devices connected to Pmod connector JC may interfere with operation of servos on the servo connectors, or alternatively, devices connected to the servo connectors may interfere with operation of a device connected to JC. Refer to the dsPIC33F data sheet for information on how to access the I/O pins.

The three pins on a servo connector provide the control signal, power and ground. There is no standard color coding for the wires on hobby servos. They are wired so that the center pin of the connector provides power to the servo. Because of this configuration with power on the center pin, the servo will not be damaged if it plugged in backwards. Generally, the center pin will have a red wire. On many servos, the ground pin will have a black wire and the signal wire will be a light color such as white or yellow. Not all servo manufacturers adhere to this convention however. The servo connectors on the Cerebot MC7 board are configured so that the signal pin (pin 1) is on the left side (toward the center of the board) and the ground pin is on the right side (toward the board edge).

RC Servos use a pulse width modulated signal, PWM, to control the servo position. The dsPIC33F microcontroller provides eight output compare units that can be used to generate the necessary pulse width modulated signal. PORTD bits 0-7 correspond to output compare unit outputs OC1-OC8. The output compare units can be operated from either Timer 2 or Timer 3. It is also possible to use timer interrupts to accomplish the generation of the PWM outputs to drive the servo connectors. Using timer interrupts allows a single timer to be used to control the signal timing for all eight servo connectors. This can be useful if some timers need to be used for other purposes.

The pulse width modulation timing varies between servo manufacturers. Generally, a pulse width of 1000us (1 milli-second) corresponds to the center of rotation, with a 500us (0.5ms) pulse width being full rotation in one direction and 1500us (1.5ms) being full rotation in the other direction. Servo manufacturers also vary on which direction of rotation is produced by narrower and wider pulses. Finally, some manufacturers produce continuous rotation servos. These generally require wider pulses. For these servos, a 1500us pulse width will result in the servo stopped and no rotation, 500us will produce rotation at full speed in one direction and 2500us full speed rotation in the other direction. This varies widely between manufacturers, however. Refer to manufacturer data sheets for the servos, or experiment to determine how specific servos operate.

RC hobby servos generally operate at 5V. Many are specified for operation at up to 6V, and some specialty servos require higher voltages. There are two power supply options for providing power to the servo connectors: The on-board 5V switching regulator, or an external power supply.

For the first case: Install shorting blocks on JP5 and JP8 to connect the VS servo power bus to the REG5V0 power bus. This connection allows for operation from a single high voltage power supply and allowing use of the servos. There are two jumpers, as the current rating on these jumper blocks is 2A, and the eight servos can potentially draw up to 4A of current from the REG5V0 power bus.

For operation from an external servo power supply, remove the shorting blocks from jumpers JP5 and JP8 and connect the external power supply to screw terminal connector J4. An external power supply should not be connected to J4 without removing the shorting blocks from JP5 and JP8. Be sure to observe the proper polarity when connecting the external power supply.

9 I²C Interfaces

The Inter-Integrated Circuit (I²C™) Interface provides a medium speed (100K or 400K bps) synchronous serial communications bus. The I²C interface provides master and slave operation using either 7 bit or 10 bit device addressing. Each device is given a unique address, and the protocol provides the ability to address packets to a specific device or to broadcast packets to all devices on the bus. Refer to the data sheet for the dsPIC microcontroller and the dsPIC33F Family Reference Manual for detailed information on configuring and using the I²C interface.

The dsPIC33F microcontroller provides two independent I²C interfaces. There are two sets of connectors in the lower left corner of the board for access to the two I²C ports. Connector J6 provides access to I²C port #1 while connector J8 provides access to I²C port #2.

Each I²C connector provides two positions for connecting to the I2C signals, ground and the 3.3V power supply. By using two-wire or four-wire MTE cables (available separately from Digiilent) a daisy chain of multiple Cerebot MC7 boards or other I²C-capable boards can be created.

The I²C bus is an open-collector bus. Devices on the bus actively drive the signals low. The high state on the I²C signals is achieved by pull-up resistors when no device is driving the lines low. One device on the I²C bus must

provide the pull-up resistors. I²C bus #2 has permanently connected pull-up resistors. I²C bus #1 has selectable pull-up resistors that can be enabled or disabled via jumper blocks on J5 and J7. The pull-ups are enabled by installing shorting blocks and are disabled by removing the shorting blocks. The shorting blocks are placed so that they line up with the SCL and SDA labels on the board. Only one device on the bus should have the pull-ups enabled.

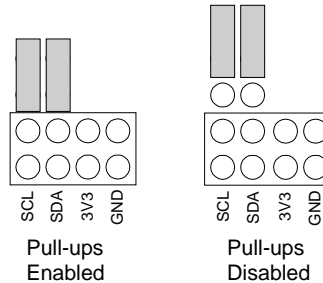

Jumper settings for I2C Pull-up resistors.

10 I²C EEPROM

The Cerebot MC7 provides one on-board I²C device, a Microchip 24LC256 serial EEPROM. This device is connected to I2C bus #2. The 24LC256 is a 256Kbit (32Kbyte) serial EEPROM device to provide non-volatile memory storage. The device address for the 24LC256 is 1010000 (0x50).

Refer to the Microchip data sheet for detailed information on the operation of this device.

11 Pmod Connectors

The Cerebot MC7 has three Pmod connectors for connecting Digiilent Pmod peripheral modules. Digiilent Pmods are a line of small peripheral modules that provide various kind of I/O interfaces. The Pmod line includes such things as button, switch and LED modules, connector modules, LCD displays, high current output drivers, and many others.

There are two styles of Pmod connector: six-pin and twelve-pin. Both connectors use standard pin headers with 100mil spaced pins. The six-pin connectors have the pins in a 1x6 configuration, while the twelve-pin connectors use a 2x6 configuration. The six-pin connectors provide four I/O signals, ground and a switchable power connection. The twelve-pin connectors provide eight I/O signals, two power and two ground pins. The twelve-pin connectors have the signals arranged so that one twelve-pin connector is equivalent to two of the six-pin connectors. The power connection is switchable between the regulated 3.3V main board supply and the unregulated input supply.

On the Cerebot MC7, Pmod connector JA is a six pin connector that can be used for general purpose I/O or for connection to UART1 or SPI1. Connector JB is a twelve pin connector that can be used for general I/O and provides access to SPI2, and two external interrupts (INT2 and INT3). Connector JC is a twelve pin connector that can be used for general I/O, plus access to the output compare units and two of the input capture units.

Digiilent Pmod peripheral modules can either be plugged directly into the connectors on the Cerebot MC7 or attached via cables. Digiilent has a variety of Pmod interconnect cables available.

See the “Connector and Jumper Block Pinout Tables” section below for more information about connecting peripheral modules and other devices to the Cerebot MC7. These tables indicate the mapping between pins on the dsPIC microcontroller and the pins on the various connectors.

12 SPI Interface

SPI is a four-wire synchronous serial communications interface used by many microcontrollers and peripheral devices.

The SPI interface is made up of the following four signals generally called: SS (slave select), MOSI (master out/slave in), MISO (master in/slave out), and SCK (serial clock). On the dsPIC microcontroller, the SPI signals are called SS (slave select), SDO (serial data out), SDI (serial data in), and SCK (serial clock).

When an SPI master device communicates with a slave device, it initiates the communication by bring the SS line low. This enables the slave device to receive the data. The master device then sends one or more bytes to the slave. The data is shifted serially out the MOSI pin to the slave. The slave device simultaneously shifts out a byte to the master on MISO. Each time a byte is sent from the master to the slave, a byte is sent from the slave to the master. The master generates the serial clock on the SCK line, and the slave uses that as the clock to shift the data in and out. When the master has finished sending data to the slave, it ends the transaction by bringing the SS line high.

The dsPIC microcontroller used on the Cerebot MC7 provides two SPI controllers. One of these controllers (SPI2) is available for use on Pmod connector JB. This SPI controller can be used as either an SPI master or an SPI slave. The other SPI controller (SPI1) is available on Pmod connector JA. The SS signal for SPI1 is not available at connector JA, and therefore SPI1 can only be used as an SPI master. When using SPI1, PORTD bit 9 (RD9) is used to drive the SS signal of the connected SPI slave.

Jumpers JP2 and JP3 are used to select whether SPI2 on connector JB is operating as an SPI master of as an SPI slave. For operation as an SPI master, JP2 (SDI2) is placed in the MISO position (to the left), and JP3 (SDO2) is placed in the MOSI position (to the right). For operation as an SPI slave, JP2 is placed in the MOSI position and JP3 is placed in the MISO position.

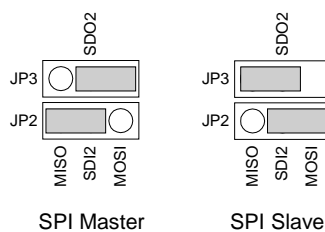

Jumper settings for SPI.

Refer to the data sheet for the dsPIC microcontroller and the dsPIC33F Family Reference Manual for detailed information on configuring and using the SPI interfaces.

12 User I/O Devices

The Cerebot MC7 board provides two push button switches for user input and four discrete LEDs for output. The buttons, BTN1 and BTN2 are connected to I/O pins RB8 and RB14 respectively. To read the buttons, bits 8 and/or 14 of PORTB must be set as inputs by setting the corresponding bits in the TRISB register and then reading the PORTB register. When a button is pressed, the corresponding bit will be high ('1').

The four LEDs are connected to bits 4-7 of PORTD. LED 1 is connected to bit 4, LED 2 is connected to bit 5, and so on. To use the LEDs, set the desired bits as outputs by clearing the corresponding bits in the TRISD register and set the bits to the desired value in the PORTD or LATD register. Setting a bit to 1 will illuminate the LED and setting the bit to 0 will turn it off.

Note that PORTD bits 4-7 are also used by Pmod connector JC and by four of the RC servo connectors.

13 CPU Clock Source

The dsPIC microcontroller on the Cerebot MC7 supports numerous clock source options for the main processor operating clock. The Cerebot MC7 board provides an external 8Mhz crystal for use with the XT oscillator option. This crystal is on the bottom of the board. Oscillator options are selected via configuration macros supplied as part of the Microchip C30 compiler suite for the dsPIC.

In addition to the crystal oscillator using the external 8Mhz, the dsPIC microcontroller also has an internal 8Mhz RC oscillator. It also provides the capability to switch clock source and clock speed during operation.

Using the internal system clock phase-locked loop (PLL), it is possible to select numerous multiples or divisions of the 8Mhz oscillator to produce CPU operating frequencies up to 40Mhz. The operating frequency can be selected using configuration macros. Refer to section 9.1 CPU Clocking System in the data sheet for the dsPIC33FJXXMCX06A/X08A/X10A family devices for information on how to set up the clock source and operating frequency.

The following example code will set the clocking options for operation at 40 MIPS.

```

/* The settings below set up the oscillator and PLL for 40 MIPS as
**follows:
**          Crystal Frequency * (DIVISOR+2)
** Fcy =    -----
**          PLLPOST * (PRESCLR+2) * 4
** Crystal = Defined in UserParms.h
** Fosc    = Crystal * dPLL defined in UserParms.h
** Fcy     = DesiredMIPS
*/

PLLFBD = (int)(40 - 2);
CLKDIVbits.PLLPOST = 0;          // N1=2
CLKDIVbits.PLLPRE = 0;          // N2=2
__builtin_write_OSCCONH(0x03);
__builtin_write_OSCCONL(0x01);

while(OSCCONbits.COSC != 0b011);
// Wait for PLL to lock
while(OSCCONbits.LOCK != 1);

```

Appendix A: Microcontroller and Connector Pinout Tables

MCU Port Bit to Pmod Connector Pin

MCU Port Bit	MCU Pin	Connector Pin	Signal	Notes
RB00	16	N/A	PGED3/AN0/VREF+/CN2/RB0	half bridge 1 current sense
RB01	15	N/A	PGEC3/AN1/VREF-/CN3/RB1	half bridge 2 current sense
RB02	14	N/A	AN2/SS1/CN4/RB2	half bridge 3 current sense
RB03	13	N/A	AN3/INDX/CN5/RB3	half bridge 4 current sense
RB04	12	N/A	AN4/QEA/IC7/CN6/RB4	motor 1, quadrature encoder input
RB05	11	N/A	AN5/QEB/IC8/CN7/RB5	motor 1, quadrature encoder input
RB06	17	N/A	PGEC1/AN6/OCFA/RB6	on-board program/debug circuit
RB07	18	N/A	PGED1/AN7/RB7	on-board program/debug circuit
RB08	21		U2CTS/AN8/RB8	BTN1
RB09	22	N/C	AN9/RB9	
RB10	23	N/A	TMS/AN10/RB10	half bridge 1, voltage sense
RB11	24	N/A	TDO/AN11/RB11	half bridge 2, voltage sense
RB12	27	N/A	TCK/AN12/RB12	half bridge 3, voltage sense
RB13	28	N/A	TDI/AN13/RB13	half bridge 4, voltage sense
RB14	29	JB-09	U2RTS/AN14/RB14	shared with BTN2
RB15	30	JB-10	AN15/OCFB/CN12/RB15	
RC12	39	N/A	OSC1/CLKIN/RC12	crystal connection
RC13	47	N/A	PGED2/SOSCI/T4CK/CN1/RC13	motor 2, quadrature encoder input
RC14	48	N/A	PEGC2/SOSCO/T1CK/CN0/RC14	motor 2, quadrature encoder input
RC15	40	N/A	OSC2/CLKO/RC15	crystal connection
RD00	46	JC-01	OC1/RD0	Servo S1
RD01	49	JC-02	OC2/RD1	Servo S2
RD02	50	JC-03	OC3/RD2	Servo S3
RD03	51	JC-04	OC4/RD3	Servo S4
RD04	52	JC-07	OC5/IC5/CN13/RD4	Servo S5, LD1
RD05	53	JC-08	OC6/IC6/CN14/RD5	Servo S6, LD2
RD06	54	JC-09	OC7/CN15/RD6	Servo S7, LD3
RD07	55	JC-10	OC8/UPDN/CN16/RD7	Servo S8, LD4
RD08	42	N/A	IC1/FLTA/INT1/RD8	bridge over-current detect
RD09	43	JA-01	IC2/U1CTS/FLTBI/INT2/RD9	UART #1
RD10	44	JB-07	IC3/INT3/RD10	
RD11	45	JB-08	IC4/INT4/RD11	
RE00	60	N/A	PWM1L/RE0	PWM1L, half bridge 1 low side
RE01	61	N/A	PWM1H/RE1	PWM1H, half bridge 1 high side
RE02	62	N/A	PWM2L/RE2	PWM2L, half bridge 2 low side
RE03	63	N/A	PWM2H/RE3	PWM2H, half bridge 2 high side
RE04	64	N/A	PWM3L/RE4	PWM3L, half bridge 3 low side
RE05	1	N/A	PWM3H/RE5	PWM3H, half bridge 3 high side
RE06	2	N/A	PWM4L/RE6	PWM4L, half bridge 4 low side
RE07	3	N/A	PWM4H/RE7	PWM4H, half bridge 4 high side

RF00	58	N/A	C1RX/RF00	CAN RX
RF01	59	N/A	C1TX/RF01	CAN TX
RF02	34	JA-03	U1RX/SDI1/RF2	UART #1 RX
RF03	33	JA-02	U1TX/SDO1/RF3	UART #1 TX
RF04	31	N/A	U2RX/SDA2/CN17/RF4	I2C Bus #2, not shared with Pmod connector
RF05	32	N/A	U2TX/SCL2/CN18/RF5	I2C Bus #2, not shared with Pmod connector
RF06	35	JA-04	U1RTS/SCK1/INT0/RF6	UART #1
RG02	37	N/A	SCL1/RG2	I2C Bus #1, not shared with Pmod connector
RG03	36	N/A	SDA1/RG3	I2C Bus #1, not shared with Pmod connector
RG06	4	JB-04	SCK2/CN8/RG6	SPI #2
RG07	5	JB-03	SDI2/CN9/RG7	SPI #2, Selectable via JP2
RG08	6	JB-02	SDO2/CN10/RG8	SPI #2, Selectable via JP3
RG09	8	JB-01	SS2/CN11/RG9	SPI #2
	7	N/A	MCLR	on-board program/debug circuit
	9	N/A	VSS	
	10	N/A	VDD	
	19	N/A	AVDD	
	20	N/A	AVSS	
	25	N/A	VSS	
	26	N/A	VDD	
	38	N/A	VDD	
	41	N/A	VSS	
	56	N/A	Vcap/VDDCORE	
	57	N/A	VDD	

Pmod Connector Pin to MCU Port Bit

Connector Pin	MCU Port Bit	MCU Pin	Signal	Notes
JA-01	RD09	43	IC2/U1CTS/FLTBI/INT2/RD9	UART #1
JA-02	RF03	33	U1TX/SDO1/RF3	UART #1 TX
JA-03	RF02	34	U1RX/SDI1/RF2	UART #1 RX
JA-04	RF06	35	U1RTS/SCK1/INT0/RF6	UART #1
JB-01	RG09	8	SS2/CN11/RG9	SPI #2
JB-02	RG08	6	SDO2/CN10/RG8	SPI #2, Selectable via JP3
JB-03	RG07	5	SDI2/CN9/RG7	SPI #2, Selectable via JP2
JB-04	RG06	4	SCK2/CN8/RG6	SPI #2
JB-07	RD10	44	IC3/INT3/RD10	
JB-08	RD11	45	IC4/INT4/RD11	
JB-09	RB14	29	U2RTS/AN14/RB14	shared with BTN2
JB-10	RB15	30	AN15/OCFB/CN12/RB15	
JC-01	RD00	46	OC1/RD0	Servo S1

JC-02	RD01	49	OC2/RD1	Servo S2
JC-03	RD02	50	OC3/RD2	Servo S3
JC-04	RD03	51	OC4/RD3	Servo S4
JC-07	RD04	52	OC5/IC5/CN13/RD4	Servo S5, LD1
JC-08	RD05	53	OC6/IC6/CN14/RD5	Servo S6, LD2
JC-09	RD06	54	OC7/CN15/RD6	Servo S7, LD3
JC-10	RD07	55	OC8/UPDN/CN16/RD7	Servo S8, LD4
N/A	RB00	16	PGED3/AN0/VREF+/CN2/RB0	half bridge 1 current sense
N/A	RB01	15	PGEC3/AN1/VREF-/CN3/RB1	half bridge 2 current sense
N/A	RB02	14	AN2/SS1/CN4/RB2	half bridge 3 current sense
N/A	RB03	13	AN3/INDX/CN5/RB3	half bridge 4 current sense
N/A	RB04	12	AN4/QEA/IC7/CN6/RB4	motor 1, quadrature encoder input
N/A	RB05	11	AN5/QEB/IC8/CN7/RB5	motor 1, quadrature encoder input
N/A	RB06	17	PGEC1/AN6/OCFA/RB6	on-board program/debug circuit
N/A	RB07	18	PGED1/AN7/RB7	on-board program/debug circuit
N/A	RB08	21	U2CTS/AN8/RB8	BTN1
N/A	RB10	23	TMS/AN10/RB10	half bridge 1, voltage sense
N/A	RB11	24	TDO/AN11/RB11	half bridge 2, voltage sense
N/A	RB12	27	TCK/AN12/RB12	half bridge 3, voltage sense
N/A	RB13	28	TDI/AN13/RB13	half bridge 4, voltage sense
N/A	RC12	39	OSC1/CLKIN/RC12	crystal connection
N/A	RC13	47	PGED2/SOSCI/T4CK/CN1/RC13	motor 2, quadrature encoder input
N/A	RC14	48	PEGC2/SOSCO/T1CK/CN0/RC14	motor 2, quadrature encoder input
N/A	RC15	40	OSC2/CLKO/RC15	crystal connection
N/A	RD08	42	IC1/FLTA/INT1/RD8	bridge over-current detect
N/A	RE00	60	PWM1L/RE0	PWM1L, half bridge 1 low side
N/A	RE01	61	PWM1H/RE1	PWM1H, half bridge 1 high side
N/A	RE02	62	PWM2L/RE2	PWM2L, half bridge 2 low side
N/A	RE03	63	PWM2H/RE3	PWM2H, half bridge 2 high side
N/A	RE04	64	PWM3L/RE4	PWM3L, half bridge 3 low side
N/A	RE05	1	PWM3H/RE5	PWM3H, half bridge 3 high side
N/A	RE06	2	PWM4L/RE6	PWM4L, half bridge 4 low side
N/A	RE07	3	PWM4H/RE7	PWM4H, half bridge 4 high side
N/A	RF00	58	C1RX/RF00	CAN RX
N/A	RF01	59	C1TX/RF01	CAN TX
N/A	RF04	31	U2RX/SDA2/CN17/RF4	I2C Bus #2, not shared with Pmod connector
N/A	RF05	32	U2TX/SCL2/CN18/RF5	I2C Bus #2, not shared with Pmod connector
N/A	RG02	37	SCL1/RG2	I2C Bus #1, not shared with Pmod connector
N/A	RG03	36	SDA1/RG3	I2C Bus #1, not shared with Pmod connector
N/A		7	MCLR	on-board program/debug circuit
N/A		9	VSS	
N/A		10	VDD	
N/A		19	AVDD	

N/A		20	AVSS	
N/A		25	VSS	
N/A		26	VDD	
N/A		38	VDD	
N/A		41	VSS	
N/A		56	Vcap/VDDCORE	
N/A		57	VDD	
N/C	RB09	22	AN9/RB9	

MCU Pin to Pmod Connector Pin

MCU Pin	MCU Port Bit	Connector Pin	Signal	Notes
1	RE05	N/A	PWM3H,RE5	PWM3H, half bridge 3 high side
2	RE06	N/A	PWM4L/RE6	PWM4L, half bridge 4 low side
3	RE07	N/A	PWM4H/RE7	PWM4H, half bridge 4 high side
4	RG06	JB-04	SCK2/CN8/RG6	SPI #2
5	RG07	JB-03	SDI2/CN9/RG7	SPI #2, Selectable via JP2
6	RG08	JB-02	SDO2/CN10/RG8	SPI #2, Selectable via JP3
7		N/A	MCLR	on-board program/debug circuit
8	RG09	JB-01	SS2/CN11/RG9	SPI #2
9		N/A	VSS	
10		N/A	VDD	
11	RB05	N/A	AN5/QEB/IC8/CN7/RB5	motor 1, quadrature encoder input
12	RB04	N/A	AN4/QEA/IC7/CN6/RB4	motor 1, quadrature encoder input
13	RB03	N/A	AN3/INDX/CN5/RB3	half bridge 4 current sense
14	RB02	N/A	AN2/SS1/CN4/RB2	half bridge 3 current sense
15	RB01	N/A	PGEC3/AN1/VREF-/CN3/RB1	half bridge 2 current sense
16	RB00	N/A	PGED3/AN0/VREF+/CN2/RB0	half bridge 1 current sense
17	RB06	N/A	PGEC1/AN6/OCFA/RB6	on-board program/debug circuit
18	RB07	N/A	PGED1/AN7/RB7	on-board program/debug circuit
19		N/A	AVDD	
20		N/A	AVSS	
21	RB08		U2CTS/AN8/RB8	BTN1
22	RB09	N/C	AN9/RB9	
23	RB10	N/A	TMS/AN10/RB10	half bridge 1, voltage sense
24	RB11	N/A	TDO/AN11/RB11	half bridge 2, voltage sense
25		N/A	VSS	
26		N/A	VDD	
27	RB12	N/A	TCK/AN12/RB12	half bridge 3, voltage sense
28	RB13	N/A	TDI/AN13/RB13	half bridge 4, voltage sense
29	RB14	JB-09	U2RTS/AN14/RB14	shared with BTN2
30	RB15	JB-10	AN15/OCFB/CN12/RB15	
31	RF04	N/A	U2RX/SDA2/CN17/RF4	I2C Bus #2, not shared with Pmod connector
32	RF05	N/A	U2TX/SCL2/CN18/RF5	I2C Bus #2, not shared with Pmod

				connector
33	RF03	JA-02	U1TX/SDO1/RF3	UART #1 TX
34	RF02	JA-03	U1RX/SDI1/RF2	UART #1 RX
35	RF06	JA-04	U1RTS/SCK1/INT0/RF6	UART #1
36	RG03	N/A	SDA1/RG3	I2C Bus #1, not shared with Pmod connector
37	RG02	N/A	SCL1/RG2	I2C Bus #1, not shared with Pmod connector
38		N/A	VDD	
39	RC12	N/A	OSC1/CLKIN/RC12	crystal connection
40	RC15	N/A	OSC2/CLKO/RC15	crystal connection
41		N/A	VSS	
42	RD08	N/A	IC1/FLTA/INT1/RD8	bridge over-current detect
43	RD09	JA-01	IC2/U1CTS/FLT/INT2/RD9	UART #1
44	RD10	JB-07	IC3/INT3/RD10	
45	RD11	JB-08	IC4/INT4/RD11	
46	RD00	JC-01	OC1/RD0	Servo S1
47	RC13	N/A	PGED2/SOSCI/T4CK/CN1/RC13	motor 2, quadrature encoder input
48	RC14	N/A	PEGC2/SOSCO/T1CK/CN0/RC14	motor 2, quadrature encoder input
49	RD01	JC-02	OC2/RD1	Servo S2
50	RD02	JC-03	OC3/RD2	Servo S3
51	RD03	JC-04	OC4/RD3	Servo S4
52	RD04	JC-07	OC5/IC5/CN13/RD4	Servo S5, LD1
53	RD05	JC-08	OC6/IC6/CN14/RD5	Servo S6, LD2
54	RD06	JC-09	OC7/CN15/RD6	Servo S7, LD3
55	RD07	JC-10	OC8/UPDN/CN16/RD7	Servo S8, LD4
56		N/A	Vcap/VDDCORE	
57		N/A	VDD	
58	RF00	N/A	C1RX/RF00	CAN RX
59	RF01	N/A	C1TX/RF01	CAN TX
60	RE00	N/A	PWM1L/RE0	PWM1L, half bridge 1 low side
61	RE01	N/A	PWM1H/RE1	PWM1H, half bridge 1 high side
62	RE02	N/A	PWM2L/RE2	PWM2L, half bridge 2 low side
63	RE03	N/A	PWM2H/RE3	PWM2H, half bridge 2 high side
64	RE04	N/A	PWM3L/RE4	PWM3L, half bridge 3 low side

Appendix B: Connector Descriptions and Jumper Settings

Label	Function
J4	<p>External Servo Power Connector</p> <p>This screw terminal connector is used to power the servo power bus from an external power supply. JP5 and JP8 must have the shorting blocks removed when using this option for powering the servo power bus.</p>
J5 & J7	<p>Pull-up enable for I²C port #1</p> <p>These two jumpers are used to enable/disable the pull-up resistors on I²C port #1. Insert shorting blocks on these two jumpers to enable the pull-up resistors. Remove the shorting blocks to disable the pull-up resistors. Only a single device on the I²C bus should have the pull-up resistors enabled.</p>
J6	<p>I²C port #1 daisy chain connector</p> <p>This connector provides access to the I²C signals, power and ground for I²C port #1.</p>
J8	<p>I²C port #2 daisy chain connector</p> <p>This connector provides access to the I²C signals, power and ground for I²C port #2.</p>
J9	<p>CAN Connector</p> <p>This connector is used to access the signals for the CAN interface.</p>
J10-J12	Do Not Use.
J13	<p>Debug USB Connector</p> <p>This connector is used to connect the on-board programming and debug circuit to the PC for use with the MPLAB® IDE.</p>
J14-J15	<p>Motor/Bridge Output Connectors</p> <p>These are used to connect external loads to the bridges. J14 provides access to the VMOT1 and VMOT2 signals. J15 provides access to the VMOT3 and VMOT4 signals. When the bridge circuits are used to form h-bridges, J14 provides access to one h-bridge and J15 provides access to the other.</p>
J16-J17	<p>Motor/Encoder #1 Connector</p> <p>J16 is a six pin JST connector that provides connection to VMOT1 and VMOT2 for use as an h-bridge to drive a motor. These are the same signals as on J14. Connector J16 also provides access to the two phase inputs to the quadrature encoder peripheral in the dsPIC microcontroller. J17 is an alternate connector for access to the quadrature encoder inputs.</p>
J18-J19	<p>Motor/Encoder #2 Connector</p> <p>J18 is a six pin JST connector that provides connection to VMOT2 and VMOT3 for use as an h-bridge to drive a motor. These are the same signals as on J15. Connector J16 also provides access to two pin-change interrupt capable pins on the dsPIC microcontroller. These inputs can be used to implement a quadrature in software. J19 is an alternate connector for access to the quadrature encoder signals.</p>
J20	<p>Motor Power Connector</p> <p>This is used to connect to the external power supply that powers the bridge circuits. This powers the high side of the bridges and provides the ground connection for the current return path.</p>
J21	<p>External Power Connector</p> <p>This is a screw terminal connector used to provide external power to the board. Be sure to observe proper polarity (marked near the connector) when providing power via this connector, or damage to the board and/or connected devices may result. This provides the input voltage to the 5V switching regulator on the board. Connectors J21, J22, and J24 are wired in parallel.</p>
J22	<p>External Power Connector</p> <p>This is a two pin header connector that provides another mean of connecting an external power supply. Connectors J21, J22, and J24 are wired in parallel.</p>
J24	<p>External Power Connector</p> <p>This is a 2.5mm x 5.5mm, center positive, coax power connector used to provide external power to the board. The optional Digiilent 5V Switching Power Supply is connected here. Connectors J21, J22, and J24 are wired in parallel.</p>

JP1	<p>CAN 5V0 Enable This jumper is used to enable/disable providing 5V to the CAN connector. Insert the shorting block to connect the board 5V0 supply to pins 9 & 10 of the CAN connector. Remove the shorting block to disconnect the 5V0 supply.</p>
JP2 & JP3	<p>SPI Master/Slave Select These jumpers are used to select whether the Cerebot MC7 is configured as an SPI master device or as an SPI slave device. See the SPI Interface section above for a discussion of how to set these jumpers.</p>
JP4	<p>Do Not Use</p>
JP5 & JP8	<p>Internal Servo Bus Power Select These jumpers are used to connect the REG5V0 bus (the output of the internal 5V switching regulator) to the servo power bus to provide power to servos. Install shorting blocks on these two jumpers to power the servo power bus from the internal power supply. Remove the shorting blocks from these two jumpers when the servo power bus is powered from an external supply</p>
JP6	<p>CAN Termination This jumper is used to enable/disable the 120 ohm termination resistor for the CAN interface. Insert the shorting block to enable the termination resistor, remove it to disable the termination resistor.</p>
JP7	<p>Do Not Use</p>
JP9, JP10, JP11, & JP12	<p>Voltage Monitoring Disconnect These jumpers are used to enable/disable monitoring the voltage at the outputs of the four half bridge circuits. With shorting blocks installed on these jumpers the voltage at the output of each bridge is connected to the dsPIC voltage monitoring analog inputs.</p>
JP14 & JP15	<p>Power supply source select This jumper is used to select the source of main board power.</p> <p>Place a shorting block on JP15 in the lower, “USB” position to have the board powered from the USB programmer/debugger connector, J13.</p> <p>Place a shorting block on JP14 in the upper, “REG” position to have the board powered from internal 5V switching regulator.</p>
S1-S8	<p>Servo Connectors These are used to connect RC servos to the board. The signals on these pins are shared with Pmod connector JC and the on-board LEDs.</p>
JA-JC	<p>Pmod Connectors These connectors provide access to the I/O pins on the PIC32MX795 microcontroller. Digiilent Pmod peripheral modules can be attached to these connectors.</p>
JPA – JPC	<p>Pmod header power select Any of the Pmod connectors can provide either regulated or unregulated power. To use regulated power, place the jumper block over the center pin and the pin marked 3V3. To use unregulated power, place the jumper block over the center pin and the pin marked 5V0.</p>

Appendix C: Measured Current Monitoring Data

Half Bridge 1: IMON1

Current (amps)	Voltage (volts)
0	0.997
0.5	1.11
1	1.213
1.5	1.318
2	1.424
2.5	1.531
3	1.638
3.5	1.747
4	1.856
4.5	1.969
5	2.084
5.5	2.2
6	2.321
Over Current Trip	5.99A

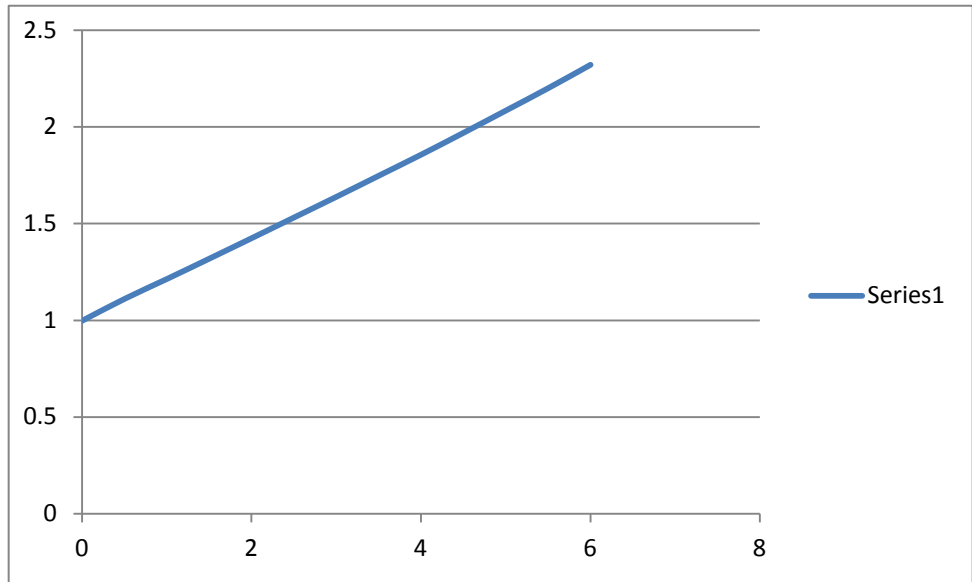

Half Bridge 2: IMON2

Current (amps)	Voltage (volts)
0	1.028
0.5	1.139
1	1.242
1.5	1.348
2	1.45
2.5	1.556
3	1.662
3.5	1.77
4	1.88
4.5	1.99
5	2.106
5.5	2.223
6	2.344
Over Current Trip	5.87

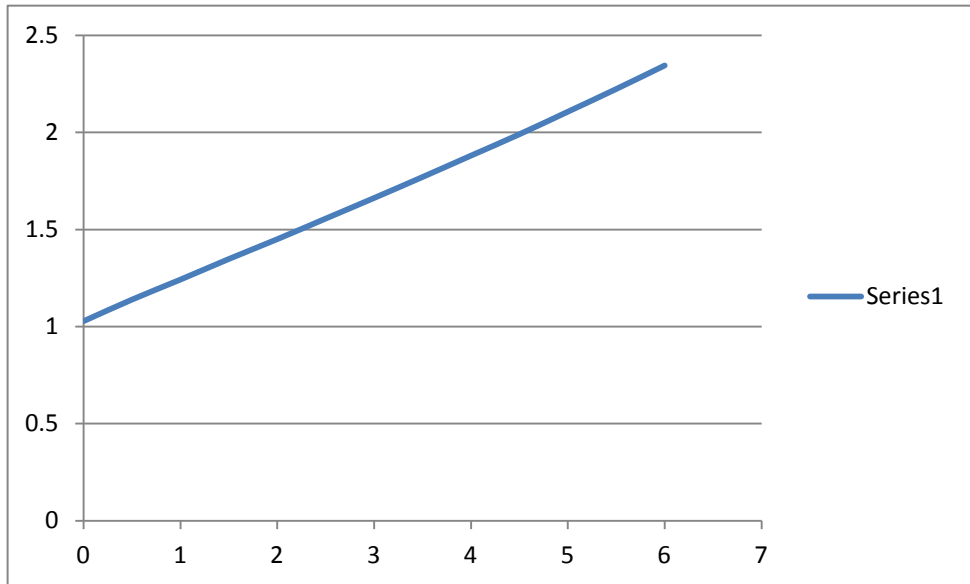

Half Bridge 3: IMON3

Current (amps)	Voltage (volts)
0	1.003
0.5	1.113
1	1.218
1.5	1.326
2	1.43
2.5	1.537
3	1.644
3.5	1.752
4	1.861
4.5	1.973
5	2.092
5.5	2.205
6	2.328
Over Current Trip	5.95

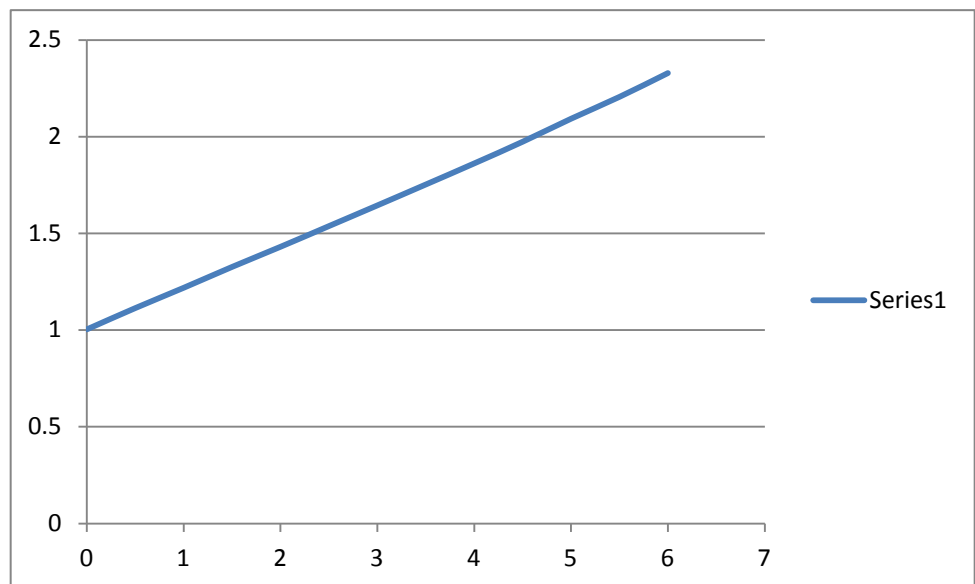

Half Bridge 4: IMON4

Current (amps)	Voltage (volts)
0	0.967
0.5	1.077
1	1.181
1.5	1.282
2	1.389
2.5	1.493
3	1.6
3.5	1.707
4	1.816
4.5	1.926
5	2.039
5.5	2.158
6	2.278
Over Current Trip	6.15

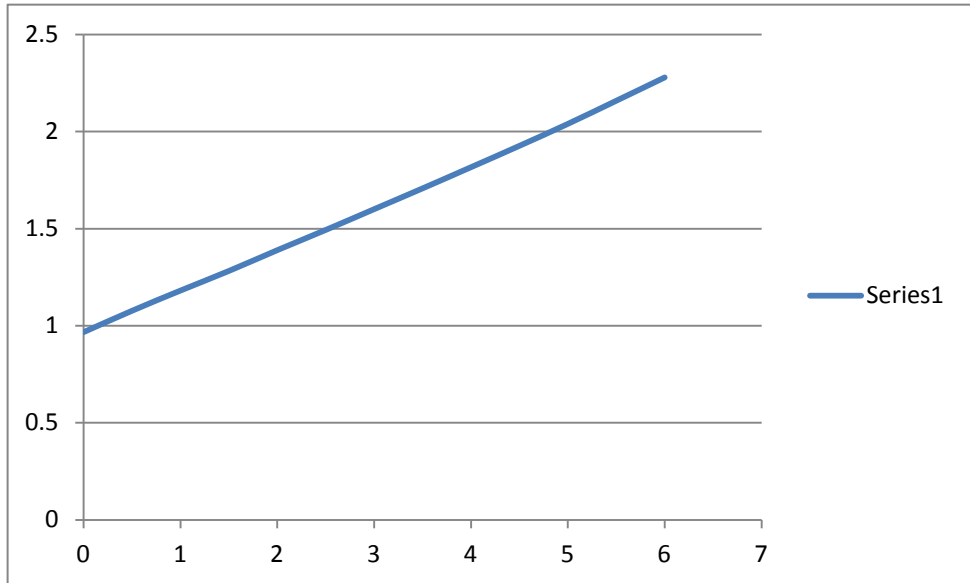

Declaration of Conformity

In accordance with EN ISO/IEC 17050-1:2010

Manufacturers Name: Digilent, Inc.
Manufacturers Address: 1300 NE Henley Court
Pullman, WA 99163
U.S.A.

Application of Council Directives:

EMC 2004/108/EC

Standards:

EMC EN55022:2010
EN55024:2010

Product Name: Cerebot MC7

Product Model Number: Digilent P/N 210-185

Digilent Product Category: Large Form Factor Microcontroller Boards

We, the undersigned, hereby declare that the equipment specified above conforms to the above Directives and Standards.

Location: Pullman, WA Signature: Clint Cole
Date: August 23, 2012 Full Name (print): Clint Cole
Title: President