

■ 10kV and 15kV MEGOHMMETERS

6550
6555



ENGLISH

User Manual

 **AEMC**[®]
INSTRUMENTS

Megohmmeter Models 6550 / 6555

Cat. #2130.31 / Cat. #2130.32

PRODUCT PACKAGING

Ships with the following:



10kV Megohmmeter Model 6550
Cat. #2130.31
or
15kV Megohmmeter Model 6555
Cat. #2130.32



Small Classic Tool Bag
Cat. #2133.72



Set of 3 color-coded (red/blue/black) 9 ft (15kV) integral leads and alligator clips (1000V CAT IV), set of 2 color-coded test probes (red/black 1000V CAT IV)
Cat. #2151.14



15kV Jumper Lead
Cat. #2151.15



Optical USB Cable
Cat. #2135.41



115V US Power Cord
Cat. #5000.14

Also Includes:

- User Manual
- DataView® Software
- 2x9.6V NiMH batteries (Cat. #2140.19 each)

Statement of Compliance

Chauvin Arnoux®, Inc. d.b.a. AEMC® Instruments certifies that this instrument has been calibrated using standards and instruments traceable to international standards.

We guarantee that at the time of shipping your instrument has met its published specifications.

An NIST traceable certificate may be requested at the time of purchase, or obtained by returning the instrument to our repair and calibration facility, for a nominal charge.

The recommended calibration interval for this instrument is 12 months and begins on the date of receipt by the customer.

For recalibration, please use our calibration services. Refer to our repair and calibration section at www.aemc.com.

Serial #: _____

Catalog #: 2130.31 / 2130.32

Model #: 6550 / 6555

Please fill in the appropriate date as indicated:

Date Received: _____













Date Calibration Due: _____



Chauvin Arnoux®, Inc.
d.b.a AEMC® Instruments
www.aemc.com

Thank you for purchasing a **Megohmmeter Model 6550/6555**.

For best results from your instrument and for your safety, read the enclosed operating instructions carefully and comply with the precautions for use. These products must be only used by qualified and trained users.

	Signifies that the instrument is protected by double or reinforced insulation.
	CAUTION - DANGER! Read the User Manual.
	Risk of electric shock. The voltage at the parts marked with this symbol may be dangerous.
	Refers to a type A current sensor. This symbol signifies that application around and removal from HAZARDOUS LIVE conductors is permitted.
	Refers to a type B current sensor. Do not apply around or remove from HAZARDOUS LIVE conductors without additional protective means (de-energizing the circuit or wearing protective clothing suitable for high voltage work).
	Important instructions to read and to fully understand.
	Useful information or tip to read.
	USB socket.
	Ground/Earth.
	The CE marking guarantees conformity with European directives and with regulations covering EMC.
	Chauvin Arnoux® Inc. d.b.a. AEMC® Instruments has adopted an Eco-Design approach in order to design this instrument. Analysis of the complete lifecycle has enabled us to control and optimize the effects of the product on the environment. In particular this instrument exceeds regulation requirements with respect to recycling and reuse.
	The trash can with a line through it means that in the European Union, the product must undergo selective disposal for the recycling of electric and electronic material, in compliance with Directive WEEE 2002/96/EC.

Precautions Before Use

This instrument and its accessories comply with safety standards IEC 61010-1, IEC 61010-031, and IEC 61010-2-030 for voltages of 1000V in Category IV at an altitude of less than 2000m, indoors, with a degree of pollution of not more than 2. Failure to observe the safety instructions may result in electric shock, fire, explosion, and destruction of the instrument and of the installations.

- The operator and/or the responsible authority must carefully read and clearly understand the various precautions to be taken in use. Sound knowledge and a keen awareness of electrical hazards are essential when using this instrument.
- If the instrument is used other than as specified, the protection it provides may be compromised, thereby endangering you.
- Do not use the instrument on networks of which the voltage or category exceeds those mentioned.
- Do not use the instrument if it seems to be damaged, incomplete, or poorly closed.
- Before each use, check the condition of the insulation on the leads, housing, and accessories. Any item of which the insulation is deteriorated (even partially) must be set aside for repair or scrapping.
- Use only the leads and accessories supplied. Using leads (or accessories) of a lower voltage or category reduces the voltage or category of the combined instrument and leads (or accessories) to that of the leads (or accessories).
- Use personal protection equipment systematically.
- Keep your hands away from the terminals of the instrument.
- When handling the leads, test probes, and alligator clips, keep your fingers behind the physical guard.
- As a safety measure, and to avoid interference, do not move and do not handle the leads during measurements.

Definition of Measurement Categories (CAT)

- **CAT IV** - 3-Phase at utility connection, outdoor conductors:
 - Origin of installation, or where low-voltage connection is made to utility power
 - Electricity meters, primary overcurrent protection equipment
 - Outside and service entrance, service drop from pole to building, runs between meter & panel
 - Overhead line to detached building, underground line to well pump
- **CAT III** - 3-Phase distribution, including single-phase commercial lighting:
 - Equipment in fixed installations, such as switchgear and polyphase motors
 - Bus and feeder in industrial plants
 - Feeders and short branch circuits, distribution panel devices
 - Appliance/equipment outlets with short connections to service entrance
- **CAT II** - Single-phase, receptacle-connected loads:
 - Appliances, portable tools, and other similar light industrial/household loads
 - Outlet and long-branch circuits
 - Outlets at more than 30 ft from CAT III source
 - Outlets at more than 60 ft from CAT IV source

TABLE OF CONTENTS

1. INTRODUCTION	5
1.1 Receiving Your Shipment.....	5
1.1.1 Accessories and Replacement Parts	5
2. PRODUCT FEATURES	6
2.1 Description.....	6
2.2 Front Panel Features.....	7
2.3 Display	8
2.3.1 Example of Display Before Measurement	8
2.3.2 Example of Display During Measurement	8
2.3.3 Example of Display After Measurement	8
2.4 Button Functions	9
2.4.1 TEMP BUTTON	9
2.4.2 ALARM Button	10
2.4.3 CONFIG Button	11
2.4.3.1 Before the Measurement	11
2.4.3.2 During the Measurement	15
2.4.4 DISPLAY Button	16
2.4.5 GRAPH Button	16
2.4.5.1 During a Measurement	16
2.4.5.2 After a Measurement	16
2.4.6 FILTER Button	18
2.4.7 HELP Button.....	19
3. INSTRUMENT CONFIGURATION.....	20
3.1 Adjusting the Brightness and Contrast.....	20
3.2 Configuring the Instrument (SET-UP).....	20
3.2.1 Configuring the Instrument using the SET-UP Function	20
3.2.2 Configurable Parameters	21
3.2.3 Resetting the Default Parameters	21
3.2.4 Measurement Parameters	22
3.2.5 Adjustment of the Test Voltages.....	23
3.2.6 Adjustment of the Alarm Thresholds	24
4. OPERATION.....	25
4.1 Charging the Batteries	25
4.2 Using the Leads.....	26
4.3 AC/DC Voltage Measurement.....	26
4.4 Insulation Measurements.....	27
4.4.1 Description of the Measurement Principle	27

4.4.2	Using a Fixed Voltage.....	28
4.4.3	Using a Variable Voltage.....	28
4.4.4	Using a Voltage Ramp.....	29
4.4.5	Using a Stepped Voltage.....	30
4.4.6	Connection.....	31
4.4.7	Before the Insulation Measurement.....	32
4.4.8	During the Insulation Measurement.....	33
4.4.9	After the Insulation Measurement.....	35
4.5	Error Indications.....	36
4.6	DAR (dielectric absorption ratio) and PI (polarization index).....	36
4.6.1	DAR/PI Measurement.....	37
4.6.2	Interpretation of the Results.....	38
4.7	DD (dielectric discharge index).....	39
4.7.1	DD Measurement.....	39
4.7.2	Interpretation of Results.....	41
4.8	Capacitance Measurement.....	41
4.9	Measurement of the Residual Current.....	41
5.	MEMORY FUNCTION.....	42
5.1	Recording a Measurement.....	42
5.2	Reading Recorded Values.....	44
5.3	Erasing the Memory.....	46
5.3.1	Erasing One Record.....	46
5.3.2	Erasing All Records.....	47
5.4	Error Codes.....	47
6.	DATAVIEW® SOFTWARE.....	48
6.1	Installing DataView.....	48
6.2	Connecting the Instrument to the PC.....	51
6.3	Megohmmeter Control Panel.....	51
6.3.1	Opening the Control Panel.....	51
7.	SPECIFICATIONS.....	52
7.1	Reference Conditions.....	52
7.2	Electrical Specifications.....	52
7.2.1	Voltage.....	52
7.2.2	Current.....	52
7.2.3	Insulation Resistance.....	53
7.2.4	DAR, PI, and DD.....	57
7.2.5	Capacitance.....	57
7.3	Power supply.....	58
7.3.1	NiMH Technology.....	58

7.3.2	Battery Charger	58
7.3.3	Optimize Battery Charging	59
7.3.4	Battery Life	59
7.3.5	“Defect” message	59
7.4	Environmental Specifications.....	60
7.5	Mechanical Specifications	60
7.6	Safety Specifications	60
7.6.1	Electromagnetic Compatibility	60
7.6.2	Mechanical Protections	60
7.7	Variations in the Domain of Use.....	61
7.8	Inherent and Operating Accuracy	61

8. MAINTENANCE 62

8.1	Recharging the Battery	62
8.2	Replacing the Battery	62
8.3	Replacing the Fuse	63
8.4	Cleaning	63
8.5	Repair and Calibration	63
8.6	Technical and Sales Assistance.....	64
8.7	Limited Warranty.....	64
8.8	Warranty Repairs	64

1. INTRODUCTION

1.1 Receiving Your Shipment

Upon receiving your shipment, make sure that the contents are consistent with the packing list. Notify your distributor of any missing items. If the equipment appears to be damaged, file a claim immediately with the carrier and notify your distributor at once, giving a detailed description of any damage. Save the damaged packing container to substantiate your claim.

Megohmmeter Model 6550 (Graphical, Analog Bargraph, Backlight, Alarm, Timer, 500V, 1000V, 2500V, 5000V, 10kV, Ramp, StepV, Variable, Auto DAR/PI/DD, USB, w/DataView® Software)..... **Cat. #2130.31**

Megohmmeter Model 6555 (Graphical, Analog Bargraph, Backlight, Alarm, Timer, 500V, 1000V, 2500V, 5000V, 15kV, Ramp, StepV, Variable, Auto DAR/PI/DD, USB, w/DataView® Software)..... **Cat. #2130.32**

Both models include set of 3 color-coded (red/blue/black) 9 ft (15kV) integral leads and alligator clips (1000V CAT IV), one 15kV jumper lead (blue), set of 2 color-coded test probes (red/black - 1000V CAT IV), optical USB cable, 115V US power cord, 9.6V rechargeable NiMH batteries, small classic tool bag, DataView® software, and a user manual.

1.1.1 Accessories and Replacement Parts

Replacement - Small classic tool bag.....	Cat. #2133.72
Replacement - Optical USB cable	Cat. #2135.41
Replacement - One 9.6V NiMH battery (two are required)	Cat. #2140.19
Replacement - Set of 3 color-coded (red/blue/black) 9 ft (15kV) integral leads and alligator clips (1000V CAT IV).....	Cat. #2151.14
Replacement - 15kV jumper lead (blue)	Cat. #2151.15
Replacement - Set of 2, color-coded (red/black) test probes (1000V CAT IV).....	Cat. #2152.23
Replacement - 115V US power cord	Cat. #5000.14
Lead - Set of 3 color-coded (red/blue/black) 9 ft shielded safety leads with hippo clips (15kV) ...	Cat. #2151.17
Lead - One shielded safety lead (black) 25 ft with hippo clips (15kV).....	Cat. #2151.18
Lead - One shielded safety lead (blue) 25 ft with hippo clips (15kV)	Cat. #2151.19
Lead - One shielded safety lead (red) 25 ft with hippo clips (15kV)	Cat. #2151.20
Lead - One shielded safety lead (black) 45 ft with hippo clips (15kV).....	Cat. #2151.21
Lead - One shielded safety lead (blue) 45 ft with hippo clips (15kV)	Cat. #2151.22
Lead - One shielded safety lead (red) 45 ft with hippo clips (15kV)	Cat. #2151.23
Power cord - 240V EU.....	Cat. #5000.32

DataView Software Updates are Available at www.aemc.com

2. PRODUCT FEATURES

2.1 Description

The Megohmmeter Models 6550 and 6555 are high-end portable measuring instruments capable of measuring very high electrical insulation and resistance values. They are packaged in a rugged IP 54 rated case, have a graphical LCD screen and can operate on battery or AC power.

The Model 6550 makes insulation measurements at voltages up to 10,000V, the Model 6555 up to 15,000V.

Their main functions are:

- detection and measurement of input voltage, frequency, and current
- quantitative and qualitative insulation measurement:
 - measurement at a fixed test voltage of 500V, 1000V, 2500V, 5000V, 10,000V or 15,000VDC
 - measurement at an adjustable test voltage from 40 to 15,000VDC
 - measurement with a voltage ramp selectable in the ranges from 40 to 1100V or from 500 to 15,000V
 - measurement with a voltage in steps from 40 to 15,000V with up to 10 steps and dwell times
 - non-destructive (Early Break) test, test stopped at a preset current (Break at I-limit) or Burning
 - calculation of the DAR, PI, and DD (dielectric discharge index) quality ratios
 - calculation of the temperature corrected resistance
- measurement of the capacitance of the circuit tested
- measurement of the residual current

These megohmmeters contribute to the safety of electrical installations and equipment.

Their operation is managed by microprocessors that acquire, process, display, and store the measurements.

They have many advantages, such as:

- digital filtering of insulation measurements
- measurement of the voltage
- programming of thresholds to trigger audible alarms
- time controlled measurements
- current limit programming
- plotting of resistance, voltage, and current vs. time and current vs. voltage: $R(t)$, $V(t)$, $I(t)$, and $I(V)$
- fuse protection, with defective fuse indication
- automatic discharge of the test voltage at the end of the measurement provides operator safety
- auto power off mode to save battery power
- battery charge condition indication
- large graphical display with backlight capability
- data storage of measurements
- real-time clock, and a USB interface
- configuration, real-time testing and data export to a PC (using the included DataView® software)

2.2 Front Panel Features

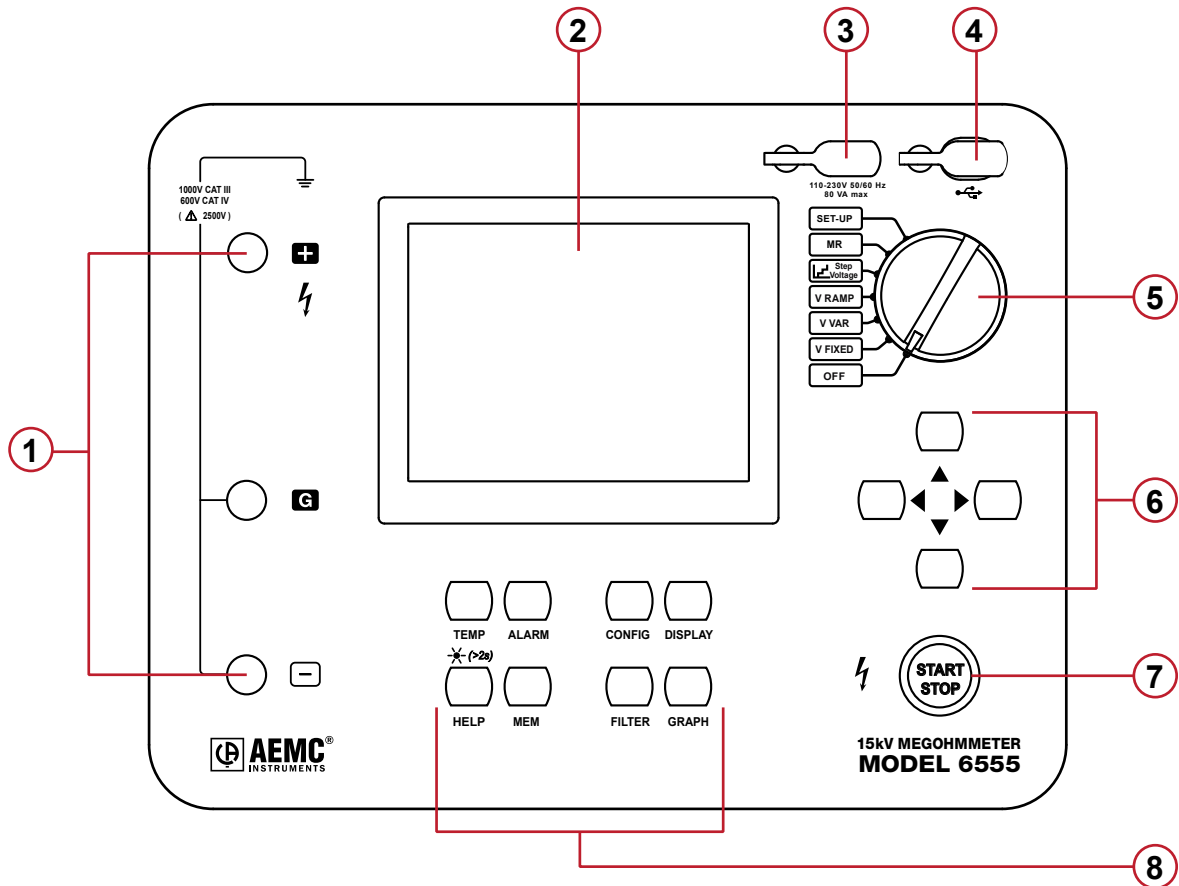

- ① Safety connection terminals “+”, “G” and “-”.
- ② Graphical, digital LCD (see § 2.3).
- ③ Power receptacle for recharging the batteries.
- ④ USB connection for communication with a PC.
- ⑤ Seven-position rotary function switch.
- ⑥ Navigation buttons for moving the cursor, selecting and changing values.
- ⑦ START/STOP measurement button.
- ⑧ Eight function buttons (see § 2.4).

2.3 Display

The display is a graphical, digital LCD with a resolution of 320 x 240 pixels. It has built-in backlight, which can be controlled by a long press on the **HELP/** button.

2.3.1 Example of Display Before Measurement

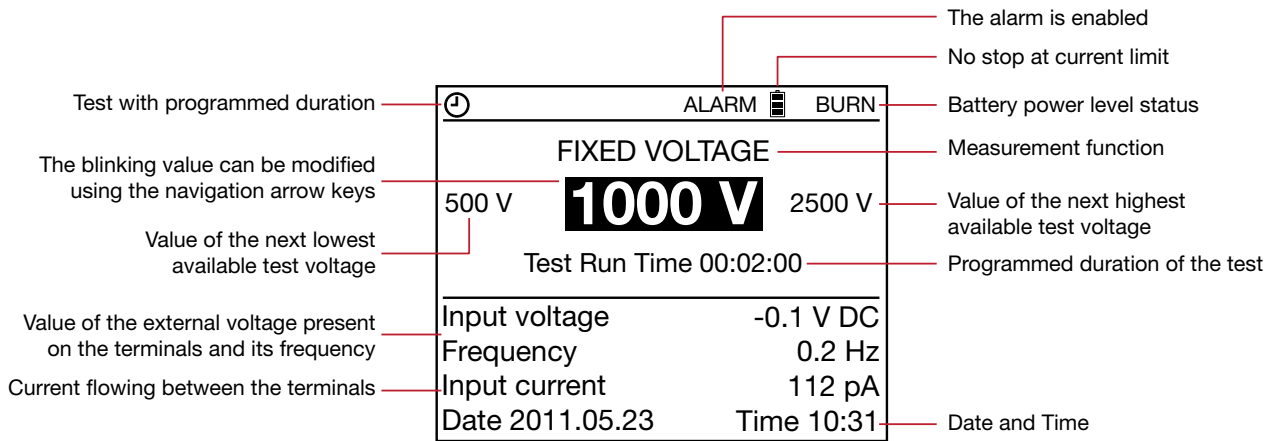

2.3.2 Example of Display During Measurement

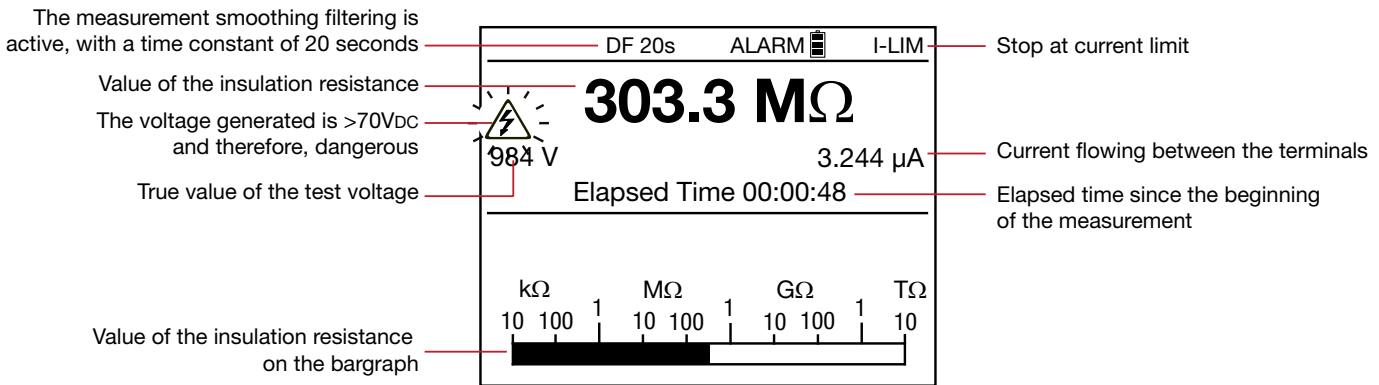

2.3.3 Example of Display After Measurement

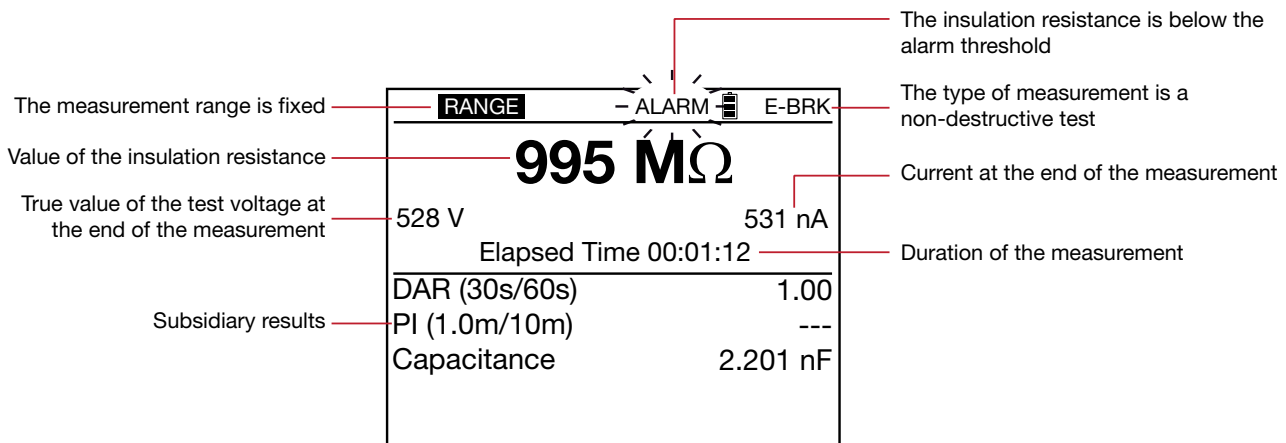

The  symbol indicates blinking.

If values are undetermined, they are represented by - - - -.

2.4 Button Functions

If the audible signal has not been deactivated in **SET-UP** (see § 3.2), the instrument confirms each button press by an audible beep. If the beep has higher frequency, this indicates that pressing the button is prohibited and will have no effect.

A long press (press maintained for more than two seconds) is confirmed by a second audible beep.

BUTTON	DESCRIPTION
TEMP	• Enter temperature and humidity information and calculate temperature corrected resistance
ALARM	• Enables/Disables the alarms
HELP / ☀	• Displays Help information; Enables/Disables the backlighting of the display
MEM	• Stores the measurements
CONFIG	• Configuration of the measurement parameters
DISPLAY	• Switch between screens
FILTER	• Smoothing of the measurements
GRAPH	• Switch graph mode ON/OFF

2.4.1 TEMP BUTTON

This function is accessible only when the measurement is completed for V-VAR and V-FIXED only. It is used to reference the measurement result to a temperature other than the one at which the measurement was made.

Temperature causes the resistance to vary according to a quasi exponential law. To a rough approximation, raising the temperature by 18°F (10°C) halves the insulation resistance; conversely, lowering the temperature by 18°F (10°C) doubles the insulation resistance.

Comparing measurements to a single reference temperature makes it easier to evaluate insulation resistance measurements taken at different times and temperatures.

Similarly, measuring the humidity improves the correlation between the various measurements made on a given device.

Procedure:

- Make a measurement in V-FIXED or V-VAR mode.
- Press the **TEMP** button.



TEMPERATURE	
☑ Air Temperature	--- °C
Humidity	--- %
Probe Temperature	--- °C
Rc Reference Temperature	--- °C
ΔT for R/2	--- °C
R measured	5.00 GΩ
Rc at --- °C	--- kΩ

Use the ◀ ▶ ▲ ▼ arrow buttons to enter the various parameters:

- **Air Temperature:** the ambient temperature (optional).
- **Humidity:** the ambient relative humidity (optional).
- **Probe Temperature:** the temperature of the device tested. If it has not warmed up during the measurement, it is equal to the ambient temperature.
- **Rc Reference Temperature:** the temperature to which the measured resistance will be referred.
- **ΔT for R/2:** the temperature variation, known or estimated, sufficient to halve the insulation resistance.

To facilitate the programming, the instrument proposes default values.

The instrument then displays the insulation resistance referred to the reference temperature.

TEMPERATURE	
▣ Air Temperature	23 °C
Humidity	40%
Probe Temperature	23 °C
Rc Reference Temperature	40 °C
ΔT for R/2	10 °C
R measured	5.00 GΩ
Rc at 40 °C	1.529 GΩ

If coefficient ΔT for R/2 is not known, it can be calculated from a minimum of 3 measurements made on the same device at different temperatures.

Detail concerning the calculation performed:

The insulation resistance varies with the measurement temperature. This dependence can be approximated by an exponential function:

$$R_c = K_t * R_t$$

where Rc: insulation resistance referred to 40°C

Rt: insulation resistance measured at temperature T

Kt: coefficient defined as follows:

$$K_t = (1/2)^{((40 - T)/\Delta T)}$$

where ΔT: temperature difference at which the insulation resistance is halved

2.4.2 ALARM Button



Press the **ALARM** button to enable the alarm defined using the **CONFIG** button (see 2.4.3) or in **SET-UP** (see § 3.2). The ALARM symbol is then displayed.

If the measurement is less than the alarm threshold, the instrument indicates this by blinking the ALARM symbol on the display and emitting an audible signal.



ALARM

Press the **ALARM** button again to disable the alarm; the ALARM symbol disappears from the display.

2.4.3 CONFIG Button

2.4.3.1 Before the Measurement

If the V-FIXED or V-VAR. test voltages have been chosen, there are two configuration screens. There is only one for the V-RAMP and V-STEP test voltages.

Press the **CONFIG** button (press CONFIG again to exit):



CONFIG	
Total Run Time	---
▶ Manual Stop	
Manual Stop + DD	
Timed Run (m:s)	2:00
Timed Run + DD	
DAR (s/s)	30/60
PI (m/m)	1.0/10

- **Manual Stop:** measurements are stopped manually.
- **Manual Stop + DD:** measurements are stopped manually and dielectric discharge ratio (DD) is calculated at the end of the programmed duration.
- **Timed Run + DD:** measurement is automatically stopped at the end of the programmed duration and dielectric discharge ratio (DD) is calculated.
- **DAR:** measurement is automatically stopped at the end of one minute (or of the programmed time, if different).
- **PI:** measurement is automatically stopped at the end of 10 minutes (or of the programmed time, if different).

It is always possible to stop a measurement during a test with programmed duration by pressing the **START/STOP** button.

The ▲▼ arrow buttons are used to select the measurement configuration.

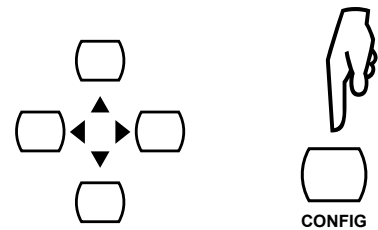

When Timed Run (test with programmed duration) or Timed Run + DD is selected, the duration of the measurement (m:s) can be set.

CONFIG	
Total Run Time	00:02:00
Manual Stop	
Manual Stop + DD	
▶ Timed Run (m:s)	2:00
Timed Run + DD	
DAR (s/s)	30/60
PI (m/m)	1.0/10

To do this, use the ◀ ▶ ▲ ▼ arrow buttons.

The test will run for the time programmed. However, if, during the measurement, the rotary switch position is changed or the **START/STOP** button is pressed, the measurement will stop.

Press the **DISPLAY** button to see the second configuration screen.



CONFIG	
▶ Test Type	Burn-in
Maximum Output Current	1 mA
I-Range	Auto(2)
Disturbance Level	Low
2500V	< 2.5 MΩ

The ▲ ▼ arrow buttons are used to select and modify a parameter.

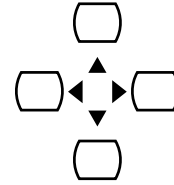

The second configuration screen depends on the rotary switch setting.

The V-RAMP and V-STEP settings only use the second page of the configuration screen.

The second configuration screen is used to choose:

- **The type of test (Test Type)**
- **Nondestructive test (Early Break)**

The measurement will be stopped at the first breakdown current peak detected. This type of test is used for non-destructive tests. The current is limited to 0.2mA.

The **E-BRK** symbol is displayed.

E-BRK		
FIXED VOLTAGE		
500 V	1000 V	2500 V
Input voltage	10 V AC	
Frequency	50.0 Hz	
Input current	24.6 pA	
Date 2011.05.23	Time 10:31	

- **Stopping the test at a preset current (Break at I-limit)**

The measurement will be stopped when the current reaches the maximum value (Maximum Output Current) defined by the user (see below). This type of test is useful for testing varistors or other types of voltage limiter.

The **I-LIM** symbol is displayed.

I-LIM		
FIXED VOLTAGE		
500 V	1000 V	2500 V
Input voltage	10 V AC	
Frequency	50.0 Hz	
Input current	24.6 pA	
Date 2011.05.23	Time 10:31	

■ Burning

The measurement is not stopped depending on the current. Depending on the application, this type of test can be used to determine the location of insulation faults when there is Burning: appearance of an electric arc during the test or burn spot after the test.

The **BURN** symbol is displayed.

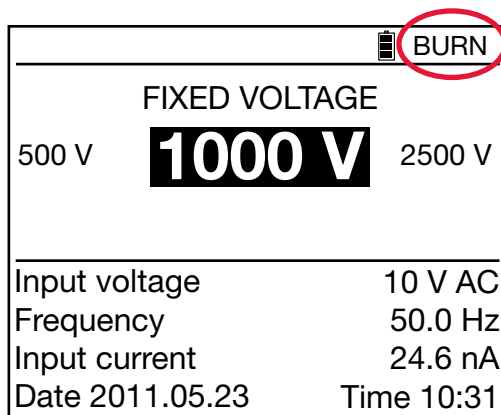

■ The Maximum Current (Maximum Output Current)

This is the current not to be exceeded in any type of test. (In the test type Break at I-limit the measurement is stopped if this value is reached.)

Use the ▲ ▼ arrow buttons to set it between 0.2 and 5mA for test types Burning and Break at I-limit. For test type Early break this value is fixed to 0.2mA.

■ The Current Range (I-range)

This function is used to make measurements more rapidly when their order of magnitude is already known.

Use the ▲ ▼ arrow buttons to set the value to Auto or Range 1, 2 or 3.

Current	< 300nA	60nA < I < 50µA	10µA < I < 6mA
Current range	1	2	3

For example for $V_N = 10,000V$:

Current range	1	2	3
Resistance	$R > 30G\Omega$	$200M\Omega < R < 16,6G\Omega$	$10M\Omega^* < R < 1 G\Omega$

* $10M\Omega$ because $I_{max} = 1mA$ at $10,000V$.

The fixed current range remains active until the instrument is switched off.

The **RANGE** symbol is displayed.

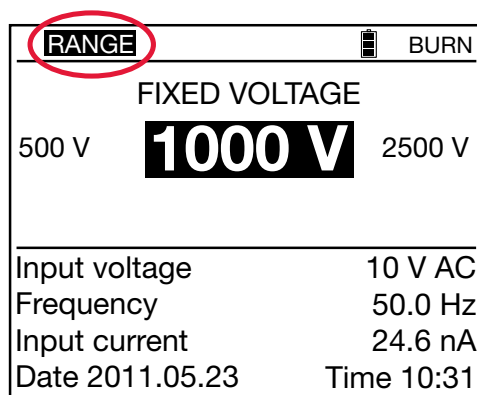

■ Interference of the Signal (Disturbance Level)

Use the ▲ ▼ arrow buttons to set the value, from Low to High. The **DH** symbol is then displayed.

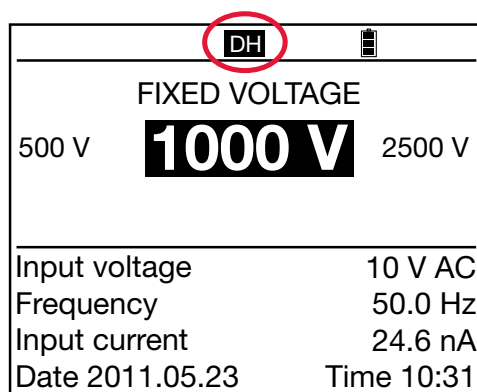

The High setting is recommended when measurements are made in the presence of strong electromagnetic fields at the network frequency (for example near high-voltage lines).

■ In the V-FIXED and V-VAR Modes: the alarm threshold

Use the ▲ ▼ arrow buttons to set the alarm threshold.

The alarm threshold can also be set in **SET-UP** (see § 3.2).

The ALARM symbol is displayed if the alarm is enabled.

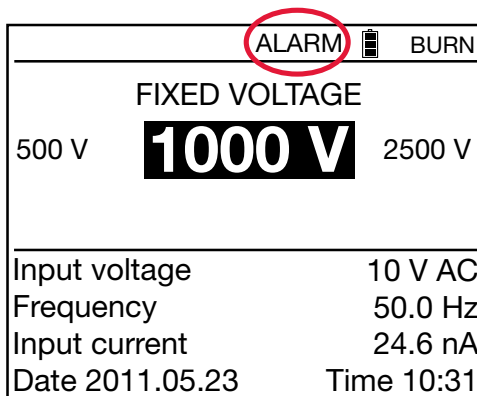

- **In the V-RAMP mode: the programming of the ramp (Set Ramp Function)**

Use the ▲▼ arrow buttons to go to Set Ramp Function; the instrument displays the voltage ramp values programming screen. This programming can also be done in **SET-UP** (see § 3.2).

- **In the V-STEP mode: the programming of the step (Set Step Function)**

Use the ▲▼ arrow buttons to go to Set Step Function; the instrument displays the voltage step values programming screen. This programming can also be done in **SET-UP** (see § 3.2).

2.4.3.2 During the Measurement

During the measurement (for V-VAR and V-FIXED), the **CONFIG** button is used to choose the current range: automatic (default) or fixed. For more details, refer to the previous section.

- Once the measurement has started, press the **CONFIG** button. The following screen appears:

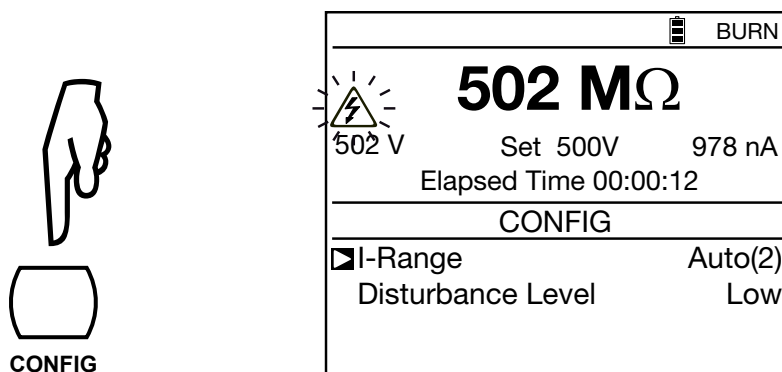

- Use the ◀▶▲▼ arrow buttons to modify the measurement current range. Changes are applied and saved immediately after entry.
- Confirm and exit by pressing the **CONFIG** button again.
- If the range is fixed, the **RANGE** symbol is displayed.
- The choice remains active until the rotary switch is moved to another position.

During the measurement, it is also possible to turn the analog filter ON/OFF (Disturbance Level). For more details, refer to the previous section.

In the case of a variable test voltage, the voltage set is also displayed and can be modified during the measurement.

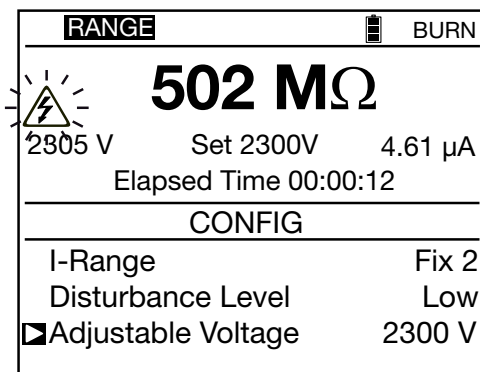

2.4.4 DISPLAY Button

This button is used to browse through the various accessible screens containing all information available before, during or after the measurement. Depending on the measurement mode and the configuration chosen (**CONFIG** button), the screens are different.

2.4.5 GRAPH Button

During the measurement, and at the end of each measurement, pressing the **GRAPH** button displays a graphical presentation of the measurement results. On the first screen, the insulation resistance vs. time $R(t)$ and the voltage vs. time $V(t)$ are shown.

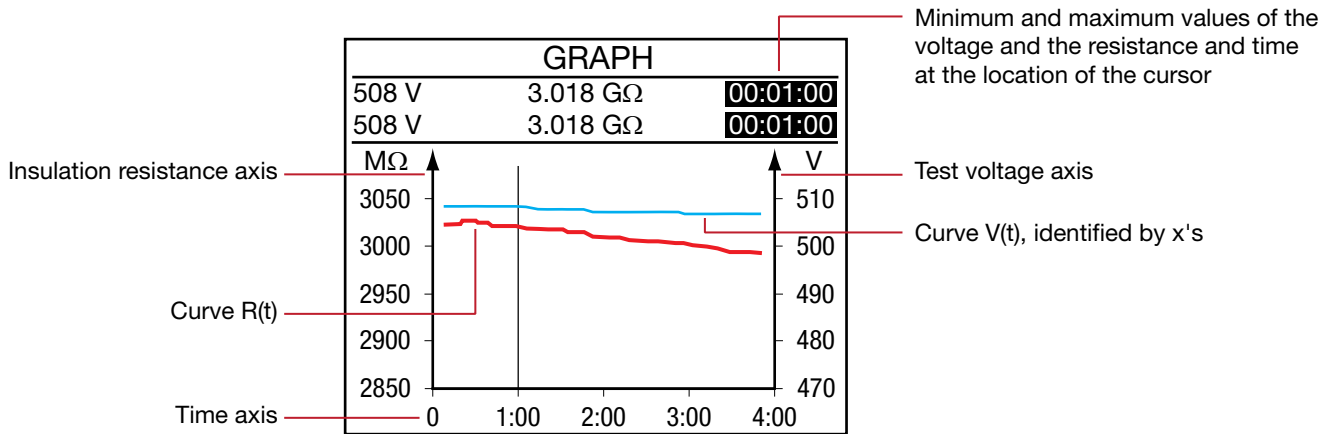

This curve is plotted using samples recorded during the measurement.

2.4.5.1 During a Measurement

There is no cursor. Each new measurement result is automatically added to the curve and its values are shown in one line above the graphical area.

2.4.5.2 After a Measurement

The time indication in the upper right of the screen is blinking, this is the indication for cursor mode.

The \blacktriangleleft \blacktriangleright arrow buttons can be used to move the time cursor along the curve. The minimum and maximum values at the cursor position are shown in two lines above the graph area. If the time span on the time axis is 4 minutes (which is the smallest possible) these lines are the same and represent one sample.

Depending on the range of the left vertical scale it may be possible to move the vertical scale and the corresponding curve with the \blacktriangleup \blacktriangledown arrow buttons.

The following is an example of the display when a measurement is performed in V-RAMP or V-STEP mode:

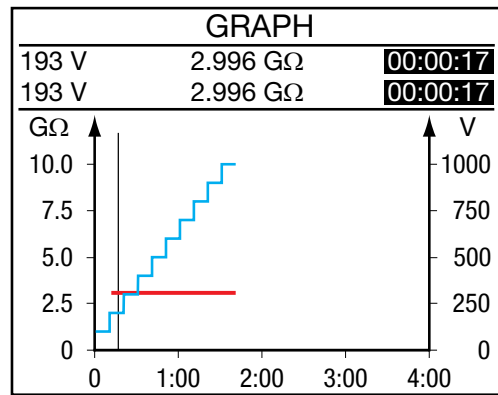
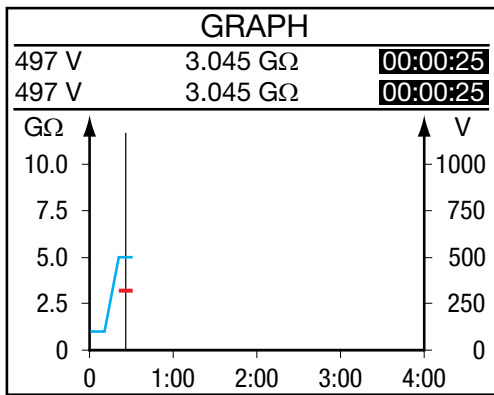

If the interval of the scale of an axis is big enough, it may be possible to zoom.

Press the **CONFIG** button.

- The time indication in the upper right of the screen stops blinking, this is the indication for zoom mode.
- The ◀ ▶ arrow buttons are used to modify the time scale of the graph.
- The ▲ ▼ arrow buttons are used to modify the resistance scale of the graph.

Press the **DISPLAY** button to view the current vs. time curve.

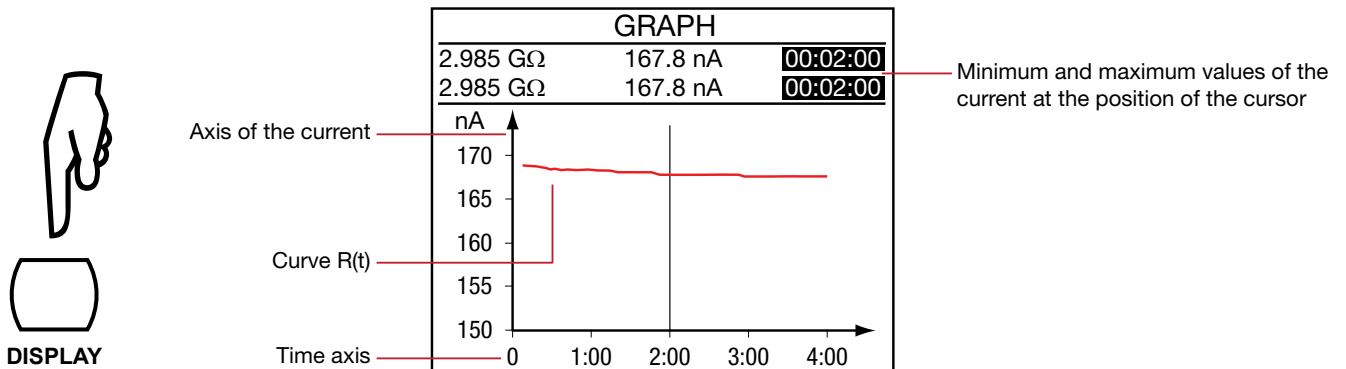

Press the **DISPLAY** button again to view the current vs. voltage data points (not available for V-STEP).

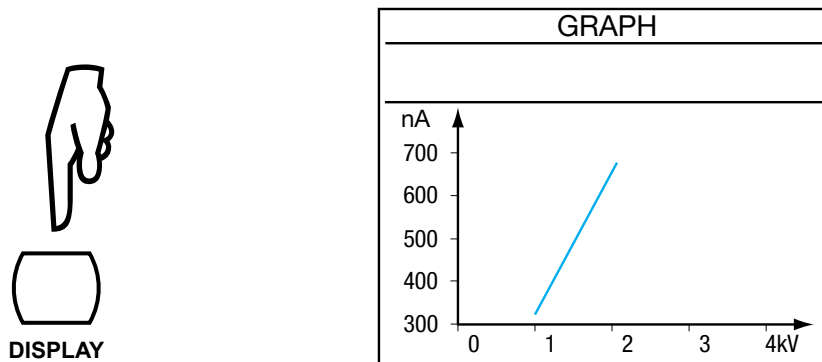

This curve is useful primarily in the case of a measurement in V-RAMP mode.

There is no cursor and it is not possible to zoom on this curve.

2.4.6 FILTER Button

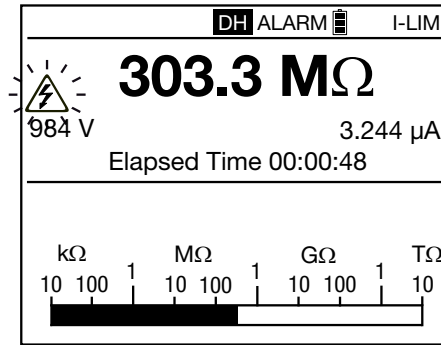

The **FILTER** button can be used to activate and deactivate a digital filter for the insulation measurements. This filter affects only the displayed results (which are smoothed), not the measured values. The recorded data therefore remains raw (no filter).

This function is useful in the case of high instability of the insulation values displayed, but it is also possible to estimate the measurement on the bargraph.

Once the measurement starts, if interference is present, press the **FILTER** button. Start by applying the DF10s filter. If that is not enough, go to the DF20s filter, then to the DF40s filter. The larger the time constant, the smoother (and slower) the measurement.

Successive presses on the **FILTER** button will modify or remove the filter:

- DF 10: time constant 10 seconds
- DF 20: time constant 20 seconds
- DF 40: time constant 40 seconds
- no filter

The filter is calculated as follows:

$$RN = RN-1 + (R - R_{N-1})/N$$

If N is set to 20, the time constant of this filter will be approximately 20 seconds.

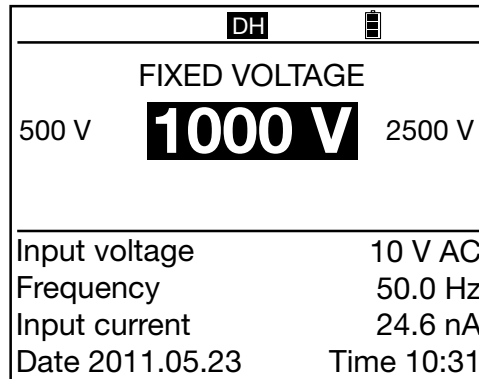

Selecting digital filtering (DF) is recommended for measurements of fluctuating high insulation resistance values. Such fluctuations may be due to hand movement, when touching the cables, fluctuating capacitances in the device tested, insulation that varies because of conducting dust, an ionizing and polarizing effect of this dust, etc., or again to the presence of an AC voltage superposed on the measurement.

The **FILTER** button is active before and during the measurement (but is not available in graph mode).

2.4.7 HELP Button

A short press on the **HELP** button opens the help function, in which the actions of the buttons are explained. This operation changes with the context: setting of the switch, operating mode, before, during, or after a measurement. Below is an example in V-FIXED mode:

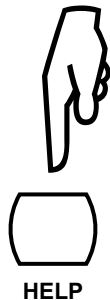

Help
DISPLAY: next page
GRAPH: graph $R(t)+V(t)$, $I(t)$, $I(V)$
CONFIG: configuration menu
FILTER: 3 digital filters DF, off
ALARM: alarm on/off
MEM: store data record menu
TEMP: temperature menu
◀▼, ▲▶: select test voltage
◀▼- lower ▲▶- higher

A long press on the **HELP** button (>2s) allows setting of the display contrast and the backlighting (see § 3.1).

3. INSTRUMENT CONFIGURATION

3.1 Adjusting the Brightness and Contrast

- Press the **HELP** button for more than two seconds.
- Press the ◀▶ buttons to adjust the contrast.
- Press the ▲▼ buttons to adjust the brightness.
- Press the **HELP** button to exit.

These adjustments are stored even after the instrument is switched off.

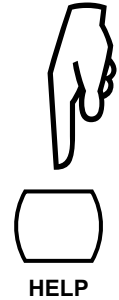
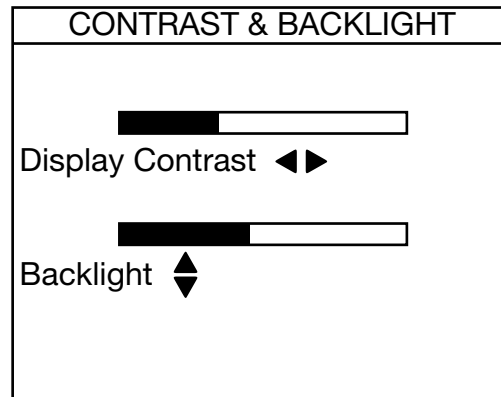
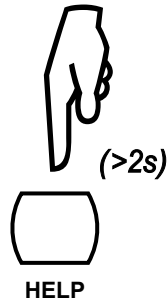

3.2 Configuring the Instrument (SET-UP)

The Models 6550/6555 are factory configured so that they can be used without modifying the parameters. For most measurements, simply choose the test voltage and press the **START/STOP** button.

Most parameters can be configured using the **CONFIG** button or in the **SET-UP** function.

- The **SET-UP** function allows overall configuration of the instrument independently of which measurement functions are chosen.
- The **CONFIG** button allows configuration of the chosen measurement function before and during a measurement.

A configuration modified in one of these two ways is updated for both (**SET-UP** function or **CONFIG** button).

3.2.1 Configuring the Instrument using the SET-UP Function

- Turn the rotary switch to the **SET-UP** position.
- Select and modify a parameter, using the ▲▼◀▶ buttons.

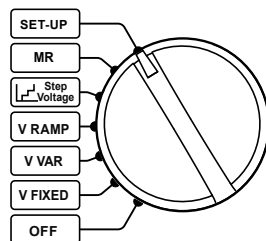

General Settings	
<input checked="" type="checkbox"/> Set Default Parameter	
Buzzer	1
Power Down	On
Baud rate	38400
Date	2011-05-25
Time	9:41
Temperature Unit	Celsius
Instrument Number	100213
Firmware	1.0.00

3.2.2 Configurable Parameters

- **Buzzer:** Sets the audible level of beeps: 1, 2, 3, or Off (no sound).
- **Auto Power OFF (power management):**
On (instrument will turn off after 5 minutes of no activity), Off (instrument will not turn off automatically).
- **Baud Rate:** Sets the data rate of the serial interface to 9600, 19200, 38400 or 57600 bauds.
- **Date:** Sets the date in yyyy-mm-dd format.
- **Time:** Sets the time in hh:mm format.
- **Temperature Unit:** Chooses the temperature unit: Celsius or Fahrenheit.
- **Instrument Number:** Indicates the number of the instrument. This line is informative and cannot be modified.
- **Firmware:** Indicates the two version numbers of the firmware in the instrument. This line is informative and cannot be modified.

3.2.3 Resetting the Default Parameters

To return to the initial configuration, choose Set Default Parameter.

The instrument requests confirmation.

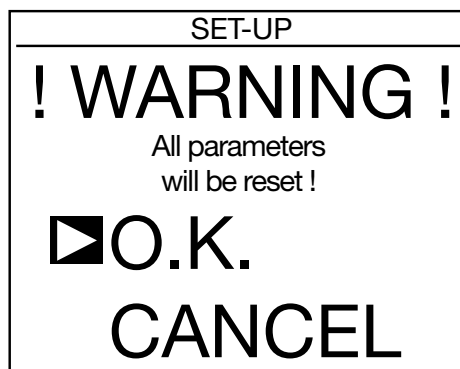

If you choose **OK**, the following default parameters will be reset:

- Audible level of the buzzer: **1**
- Auto Power OFF: will be set to **OFF**
- Data rate: **38,400 baud**
- Programmed measurement duration: **2 minutes**
- Sampling duration: **10 seconds**
- DAR: **30/60** and PI: **1/10**
- Test type: **Burning**
- Maximum output current: **5mA**
- Maximum output voltage: **10kV** (6550), **15kV** (6555)
- Adjustable test voltages: **50V, 800V and 7000V**
- Ramp and step test voltages return to their original values, as do all alarm thresholds
- The backlight will be turned off

3.2.4 Measurement Parameters

Press the **DISPLAY** button to see the following:

Timed Run: Set the measurement duration (in minutes:seconds) for measurements with programmed duration.

- The adjustment range is from 00:01 to 99:59, in 1-second steps.

DAR: Set the time at which the measurements must be recorded to calculate the DAR (see § 4.6). This can be used in special applications.

- The first time can be set from 10 to 90 seconds in 5-second steps.
- The second time can be set from 15 to 180 seconds in 5-second steps.

PI: Set the time at which the measurements must be recorded to calculate the PI (see § 4.6). This can be used in special applications.

- The first time can be set from 0.5 to 30 minutes in 0.5- then 1-minute steps.
- The second time can be set from 0.5 to 90 minutes in 0.5-, 1-, and 5-minute steps.



Test Timing	
<input checked="" type="checkbox"/> Timed Run (m:s)	2:00
DAR (s/s)	30/60
PI (m/m)	1.0/10

Press the **DISPLAY** button to see the following:

Test Type: Choose the type of test: Burning, Early-Break, or Break at I-Limit.

Maximum Output Current: Set the maximum output current, from 0.2 to 5mA.

Maximum Output Voltage: Set the maximum output voltage. This can be useful to prevent handling errors, thus making it possible to entrust the instrument to less experienced users for particular applications (e.g. telephone, aviation, etc.) where it is important not to exceed a maximum test voltage.

Example: If the maximum voltage is set to 750V, the measurement will be made at 500V for the 500V fixed voltage, and at a maximum of 750V for all other fixed voltages.

The adjustment range is from 40 to 10,000V (15,000V for Model 6555).



Test Parameters	
<input checked="" type="checkbox"/> Test Type	Burn-in
Maximum Output Current	5.0 mA
Maximum Output Voltage	15000 V
Adjustable Voltage 1	50 V
Adjustable Voltage 2	500 V
Adjustable Voltage 3	2500 V

3.2.5 Adjustment of the Test Voltages

Always on the third **SET-UP** screen.

Adjustable Voltage 1, 2, and 3: Set the values of the 3 adjustable test voltages.

The adjustment range is from 40 to 15,000V.

Press the **DISPLAY** button to see the following:



Step & Ramp Functions	
<input checked="" type="checkbox"/>	Set Step Function 1
	Set Step Function 2
	Set Step Function 3
	Set Ramp Function 1
	Set Ramp Function 2
	Set Ramp Function 3

Set Step Function 1, 2, and 3: In the case of a measurement with a stepped voltage, used to set the voltages and the durations of the steps.

Pressing the **▶** button opens the following screen. Press the **DISPLAY** button to view the rest of the steps.

Step & Ramp Functions		
Step Function 1		
Step	Voltage	Duration (m:s)
<input checked="" type="checkbox"/> 1	50 V	0:10
2	100 V	0:10
3	150 V	0:10
4	200 V	0:10
5	250 V	0:10
Total Run Time (m:s)		1:40



Step & Ramp Functions		
Step Function 1		
Step	Voltage	Duration (m:s)
<input checked="" type="checkbox"/> 6	300 V	0:10
7	350 V	0:10
8	400 V	0:10
9	450 V	0:10
10	500 V	0:10
Total Run Time (m:s)		1:40

You can then set the voltage and duration of each of the 10 steps. The total duration of the measurement (Total Run Time) is calculated by the instrument.

The adjustment range of the voltages is from 40 to 15,000V.

The duration of the steps ranges from zero or 0:01 to 99:59. If a duration is set to zero, the time displayed is -:--. A duration below 30 seconds is not very useful because acquiring a stable resistance result requires some time.

If either a step voltage or a step duration is set to zero, the step will be set to zero as a whole and will be skipped during the test.

Set Ramp Function 1, 2, and 3: In the case of a measurement with a ramped voltage, used to set the starting voltage, the slope of the ramp, and the final voltage.

Pressing the ► button opens the following screen:

Step & Ramp Functions		
Ramp Function 1		
Step	Voltage	Duration (m:s)
▣ Start	50 V	0:10
Ramp		0:10
End	100 V	0:10
Total Run Time (m:s)		0:30

You can then set the voltage and duration of the starting level and of the final level, along with the duration of the ramp. The total duration of the measurement (Total Run Time) is calculated by the instrument.

The voltages can be adjusted in two ranges: between 40V and 1100V or between 500V and 15,000V.

The duration of the steps can range from Start 0:30, Ramp 0:10, End 0:10 to 99:59.

Press the ◀ arrow button to exit the menu and go back to the main menu.

3.2.6 Adjustment of the Alarm Thresholds

Press the **DISPLAY** button to see the following:

An audible alarm is triggered for voltages below the following alarm thresholds. There is one for each fixed or adjustable voltage and all of them can be modified.



- For a test voltage of 500V, the alarm threshold is adjustable from 10kΩ to 2TΩ.
- For a test voltage of 1000V, the alarm threshold is adjustable from 10kΩ to 4TΩ.
- For a test voltage of 2500V, the alarm threshold is adjustable from 10kΩ to 10TΩ.
- For a test voltage of 5000V, the alarm threshold is adjustable from 10kΩ to 15TΩ.
- For a test voltage of 10,000V, the alarm threshold is adjustable from 10kΩ to 25TΩ.
- For a test voltage of 15,000V, the alarm threshold is adjustable from 10kΩ to 30TΩ.
- For the adjustable test voltages, the alarm threshold depends on the voltage. It is adjustable between two values that depend on the test voltage.

Alarm Settings	
▣500 V	< 500 kΩ
1000 V	< 1.0 MΩ
2500 V	< 2.5 MΩ
5000 V	< 5.0 MΩ
10000 V	< 10 MΩ
15000 V	< 15 MΩ
Adjustable Voltage 1	< 50 kΩ
Adjustable Voltage 2	< 100 kΩ
Adjustable Voltage 3	< 250 kΩ

Press the **DISPLAY** button again to return to the first **SET-UP** screen.

4. OPERATION

4.1 Charging the Batteries



NOTE: When using the instrument for the first time, start by fully charging the batteries. Charging must be conducted at a temperature between 32° and 86°F (0° and 30°C).

To charge the batteries:

1. Set the rotary switch to the **OFF** position.
2. Connect the power cord.

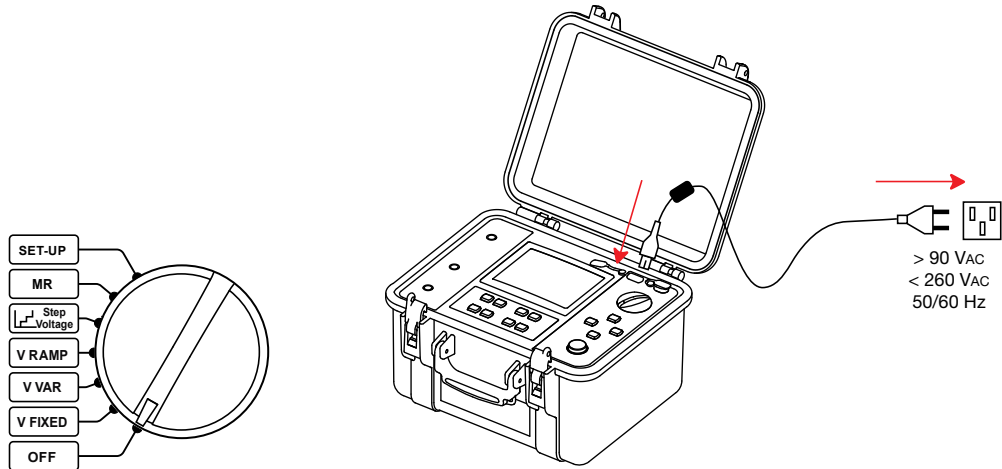

During the charging, the instrument displays the following information:

Battery 1	2%	Charging
	12.4 V	
	1953 mA	
	26.4°C	
	00:05:30	
Battery 2	3%	
	11.7V	
	13 mA	
	26.7°C	
	00:05:20	

The percentage charge of each of the batteries, their voltages, their charging currents, their temperatures, and the charging times.

To reduce the power to be supplied and make it possible to use the instrument during the charging, the batteries are charged alternately at 2A for 10 seconds. It is for this reason that the charging current varies.

The text on the side indicates:

- Charging = battery being charged
- Full = battery fully charged
- Cold = battery too cold to be charged
- Hot = battery too hot to be charged
- Defect = battery faulty (must be replaced)

Charging time: Between 6 and 10 hours, depending on the initial charge condition.

When the instrument is switched-on, the battery state information is accessible by pressing the **HELP** button followed by **TEMP** button. Following prolonged storage, the batteries may be completely discharged. In this case, the first charge may take longer.

It is possible to charge the instrument during operation. In this case the  symbol flashes.

The charging current then depends on the test voltage and on the resistance measured. If the power necessary for the measurement approaches 10W, the batteries are not charged.

4.2 Using the Leads

Specific leads are supplied with the instrument. To use them, attach either the test probes or alligator clips (supplied with the instrument).

⚠ NOTE: These accessories have hand guards. For safety reasons, the user's hands must always be behind the hand guard.

Always keep hands behind this protective guard:

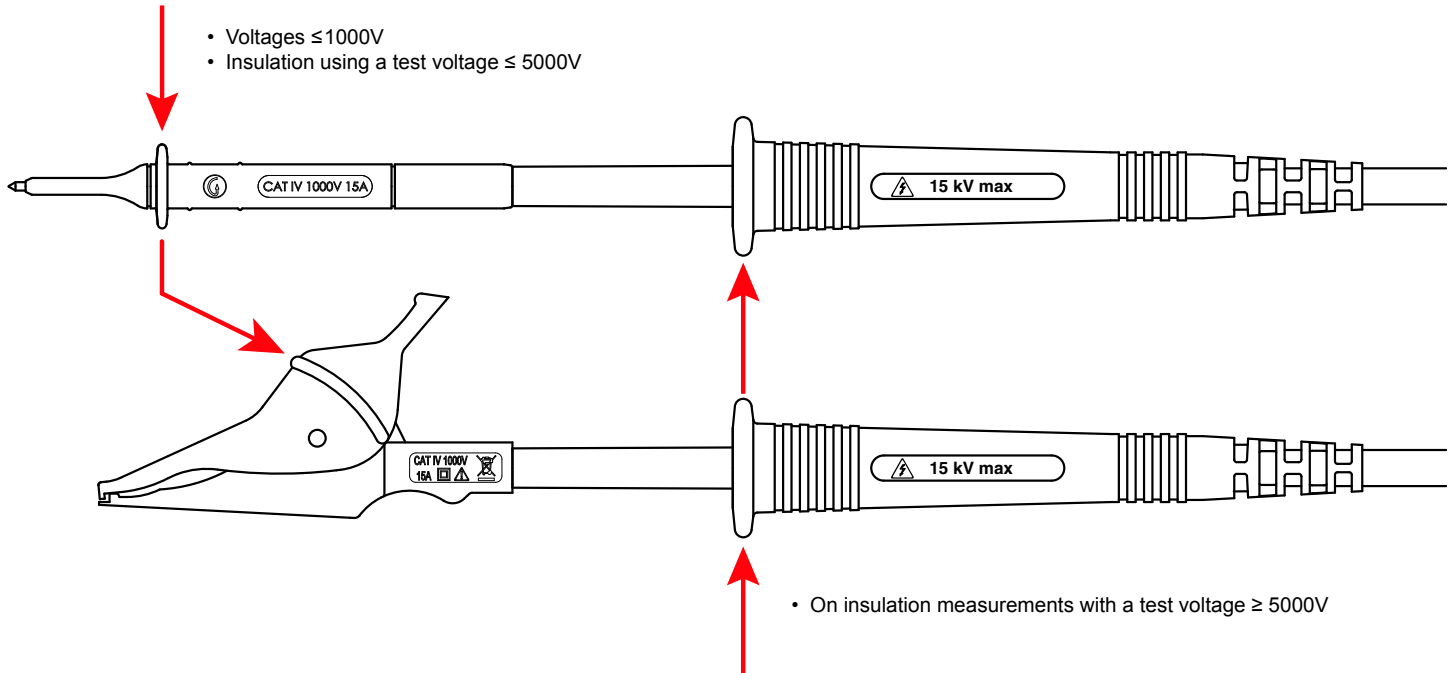

Measurements of voltages $\geq 1000V$ on supply lines should be made using the test probes only, with the user's hands behind the hand guard on the lead.

⚠ WARNING: The leads with large clips (automobile battery charger type) proposed as accessories should not be used for line voltage measurements because their jaws are not insulated.

4.3 AC/DC Voltage Measurement

Turning the switch to any insulation measurement position (V-FIXED, V-VAR, V-RAMP, or V-STEP) sets the instrument to AC/DC voltage measurement. The voltage between the input terminals is measured at all times and indicated as RMS value on the display unit: Input Voltage. Switching between AC and DC mode is automatic.

In the case of an AC signal, the instrument measures the frequency. It also measures the residual DC current between the terminals of the instrument. This measurement is used to evaluate its impact on the insulation measurement about to be made.

The insulation measurements cannot be started if there is an excessively high external voltage ($>0.4V_N$ where V_N is the test voltage, with a maximum of $1000V_{AC}$) on the terminals.

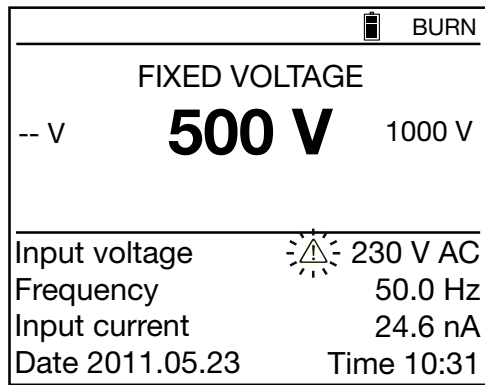

When the external voltage exceeds 25V, the blinking () symbol is displayed alongside it.



NOTE: By pressing the **DISPLAY** button, the screen can be switched to a big numerical indication of the input voltage and its bargraph.

The only errors possible in a voltage measurement are:

- The frequency is outside the measurement range (see § 7.2.1)
- The voltage is outside the measurement range (see § 7.2.1)

4.4 Insulation Measurements



Insulation measurements are made on objects that are de-energized.

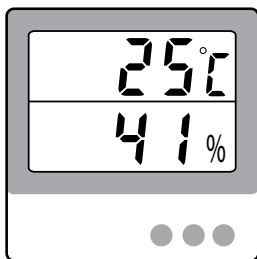

This measurement varies greatly with the temperature and the relative humidity. It is therefore essential to measure them with a separate device and to record them with the insulation value.

The ambient temperature can be entered in the instrument and stored with the measurement results.

The value of the test voltage is generally twice the voltage at which the object to be tested is used, unless a standard stipulates otherwise.

For example, for a motor that operates on a 230V supply, the test will be performed at 500V.

4.4.1 Description of the Measurement Principle

The instrument generates a DC test voltage equal to the chosen nominal voltage V_N between the + and - terminals. More precisely, the value of this voltage depends on the resistance to be measured (see the curves of § 7.2.3). The instrument measures the voltage and the current between the two terminals and from them deduces $R=V/I$.

The instrument measures the external voltage present on the terminals. It can make the measurement if the peak voltage is less than $0.4V_N$ or 1000VAC maximum. Beyond this value, it does not make the measurement.

4.4.2 Using a Fixed Voltage

Set the switch to the **V-FIXED** position. The following screen appears:

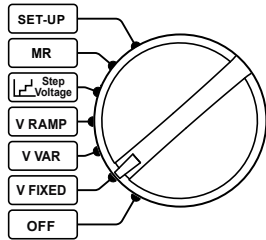

FIXED VOLTAGE	
-- V	500 V 1000 V
Input voltage	10 V AC
Frequency	50.0 Hz
Input current	24.6 pA
Date 2011.05.23	Time 10:31

Use the ◀ ▶ ▲ ▼ buttons to select the test voltage: 500V, 1000V, 2500V, 5000V, 10,000V or 15,000Vdc.

The instrument generates exactly the selected voltage when the measured resistance is high. When the measured resistance is low, the output voltage decreases because of a voltage drop on a series resistance of 234kΩ internal to the instrument.

For example, if a test with 1000V should be performed, use the V-VAR function and adjust V so that the displayed voltage during measurement is 1000V (set voltage will be higher by a term $I_m * 234k\Omega$) - see § 2.4.3.2.

4.4.3 Using a Variable Voltage

Set the switch to the **V-VAR** position. The following screen appears:

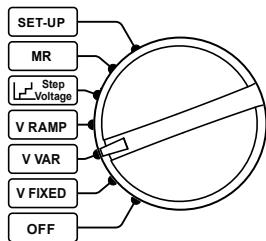

ADJUSTABLE VOLTAGE 1	
	50 V
Input voltage	0.1 V AC
Frequency	0.2 Hz
Input current	11.56 pA
Date 2011.05.24	Time 15:31

There are already 3 preset voltages that can be modified in **SET-UP** (see § 3.2). Use the ▲ ▼ buttons to select one of them:

- Adjustable Voltage 1: 50V
- Adjustable Voltage 2: 800V
- Adjustable Voltage 3: 7000V

Otherwise, use the ◀ ▶ buttons to go to the voltage value, then use the ▲ ▼ buttons to adjust the value of the test voltage. The adjustment is in 10V steps up to 1000V, and in 100V steps above 1000V. Keeping the buttons pressed will speed up the adjustment.

ADJUSTABLE VOLTAGE	
750 V	
Input voltage	0.1 V AC
Frequency	0.2 Hz
Input current	11.56 pA
Date 2011.05.24	Time 15:31

4.4.4 Using a Voltage Ramp

This test is based on the principle that an ideal insulation produces the same resistance whatever the test voltage applied.

Any negative variation of the insulation resistance therefore means that the insulation is defective: the resistance of defective insulation decreases as the test voltage increases. This phenomenon is barely observable with low test voltages. At least 2500V must therefore be applied.

Since the application of the voltage is gradual, it causes no premature ageing or deterioration of the device tested. Unlike the increase in steps, the gradual increase of the current means that the capacitive current is constant. A variation of the current therefore directly represents a variation of the insulation resistance.

Evaluating the result:

- A negative slope of the resistance versus test voltage curve exceeding 500ppm/V generally indicates the presence of mildew or other deterioration.
- A larger negative slope, or a sudden drop, indicates the presence of localized physical damage (arcing, perforation of the insulation, etc).

The test with a voltage ramp is ideally suited for testing semiconductors (diodes, transistors, and thyristors). Take care in this case to choose a non-destructive type of test: Break at I-limit (see § 2.4.3) and a maximum output current less than or equal to 1mA.

Set the switch to the **V-RAMP** position. The following screen appears:

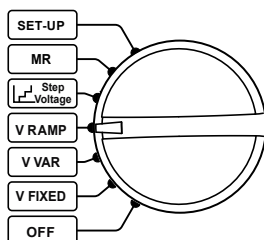

RAMP FUNCTION 1	
Min. 50 V	Max. 100 V
Test Run Time 00:00:30	
Input voltage	-0.1 V DC
Frequency	0.2 Hz
Input current	55.7 nA
Date 2011.05.24	Time 15:31

Use the ▲▼ buttons to select a preset test voltage ramp:

- Ramp function 1: 50 to 500V
- Ramp function 2: 500 to 5000V
- Ramp function 3: 1000 to 10,000V

The voltages at the beginning and end of the ramp can be programmed with the **CONFIG** button (see § 2.4.3). The duration of the test is the sum of the three durations specified: the duration of the initial level, the duration of the ramp, and the duration of the final level.

4.4.5 Using a Stepped Voltage

The preset stepped voltage tests have ten levels. The duration of each of the voltage levels is identical. At the end of each level, the capacitive current should be zero and only the measurement current remains.

Unlike the ramp test, the step test stresses the insulation and can cause a breakdown. A sudden increase of the current (or a sudden decrease of the insulation resistance) means that a breakdown point is near. It is then possible to discontinue the measurement manually by pressing the **START/STOP** button or automatically using E-BRK or Break at I-Limit type of test (see § 2.4.3).

A drop of 25% or more between the insulation resistance of the first level and that of the second level is a sign of deterioration of the insulation.

Set the rotary switch to the **V-STEP** position. The following screen appears:

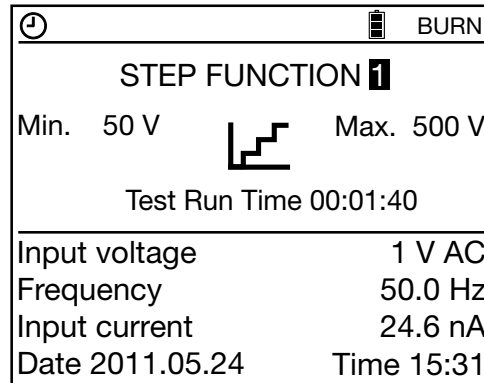
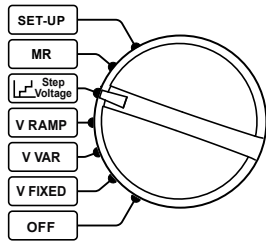

Use the ▲▼ arrow buttons to choose the preset step type of test:

- Step function 1: 50 to 500V
- Step function 2: 500 to 5000V
- Step function 3: 1000 to 10,000V

The voltage and the duration of each step can be programmed using the **CONFIG** button (see § 2.4.3).

4.4.6 Connection

Depending on the measurements to be made, there are three ways of connecting the instrument. In all cases, disconnect the device to be tested from the supply line.

■ Low Insulation

Connect the red high-voltage lead between earth and the + terminal of the instrument. Connect the black high-voltage lead between one phase of the motor and the - terminal of the instrument.

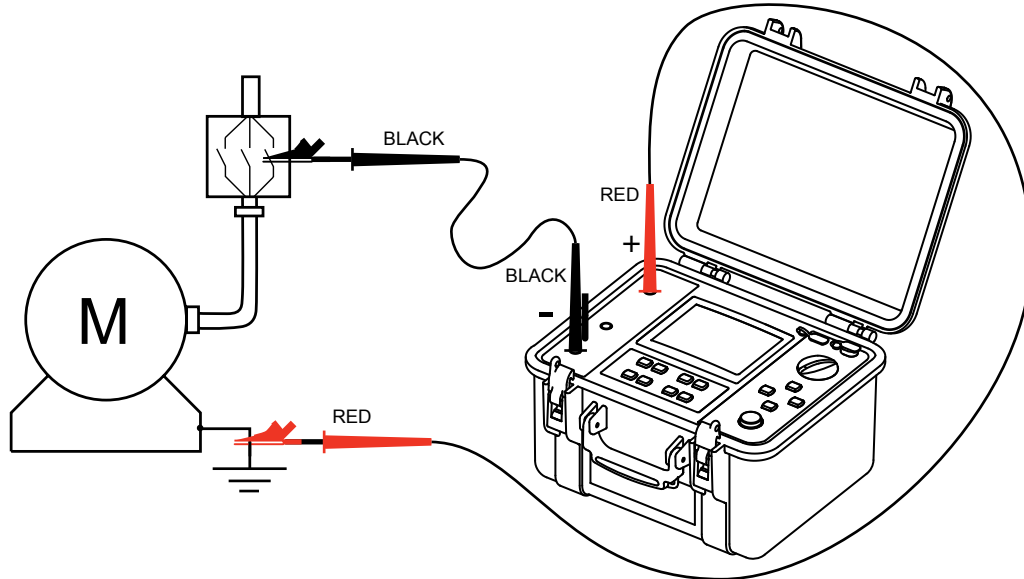

■ High Insulation

For very high insulation values, connect the small blue high-voltage lead between the rear pick-up of the black lead and the **G** terminal - in this case the shield of black lead will be connected to the ground of the instrument, which helps to avoid leakage current and capacitive current effects.

This reduces the influence of the operator's hands on the test leads and gives a more stable measurement.

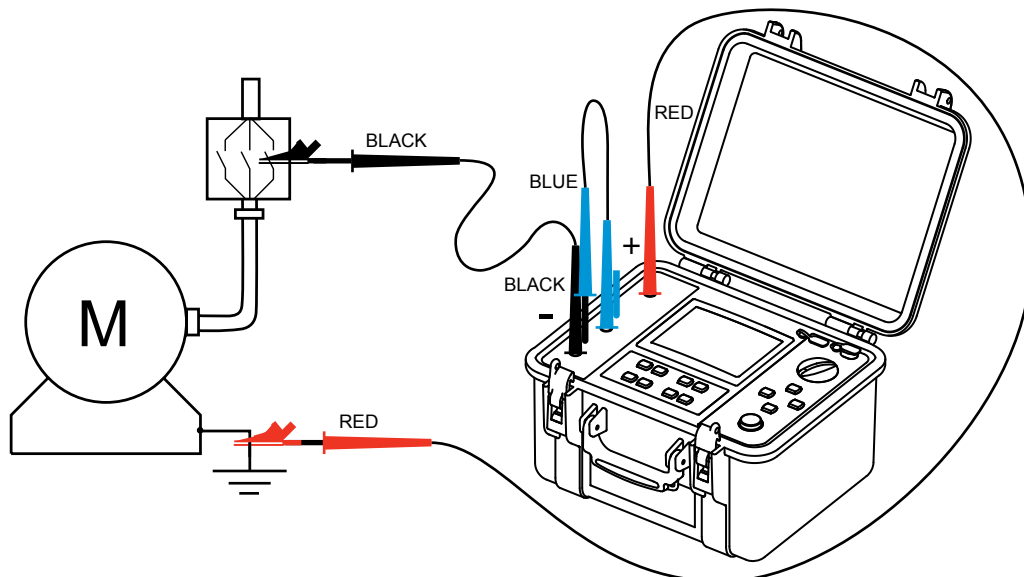

■ Cable

Connect the red high-voltage lead between the braid and the + terminal of the instrument.

Connect the black high-voltage lead between the core and the - terminal of the instrument.

Connect the blue high-voltage lead between the insulation and the **G** terminal of the instrument.

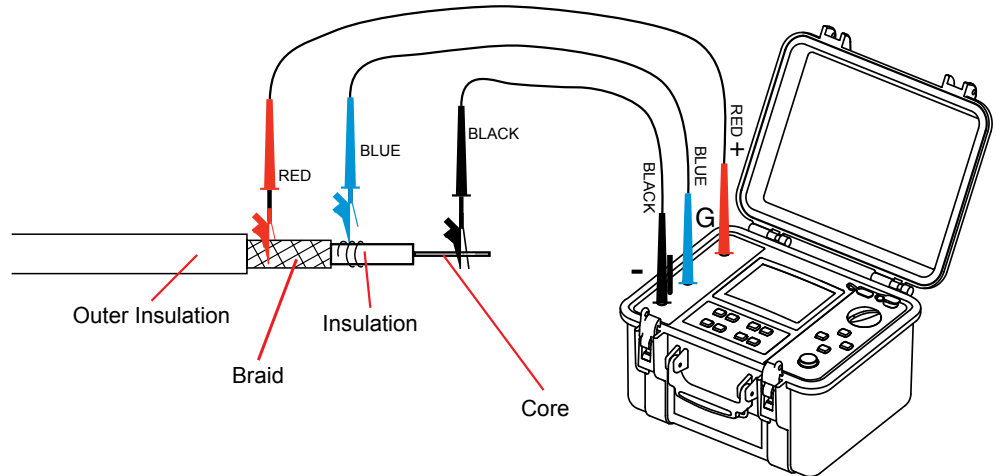

Using the guard eliminates the influence of the surface leakage current.

4.4.7 Before the Insulation Measurement

It is possible to configure the measurement using the **CONFIG** button:



If the V-FIXED or V-VAR test voltages have been selected, it is possible to select a measurement configuration by pressing the **CONFIG** button:

- Manual Stop
- Manual Stop + DD
- Timed Run
- Timed Run + DD
- DAR
- PI



Then set the type of test, the maximum current, the current range, the filtering of the measurement, and the value of the alarm threshold by pressing the **DISPLAY** button:

- Test Type
- Maximum Output Current
- I-range
- Disturbance Level
- Alarm

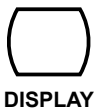

To enable the alarm, press the **ALARM** button. The ALARM symbol will appear in the status line. The ALARM symbol in the status line will blink and (if the buzzer is switched on) an audible beep will sound if the result of the measurement is below the programmed threshold.

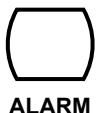

4.4.8 During the Insulation Measurement

Press the **START/STOP** button to start the measurement.

The instrument generates high voltage. To indicate that the measurement is in progress, the instrument emits an audible beep every ten seconds (if the buzzer is switched on) and the **START/STOP** button lights up red.

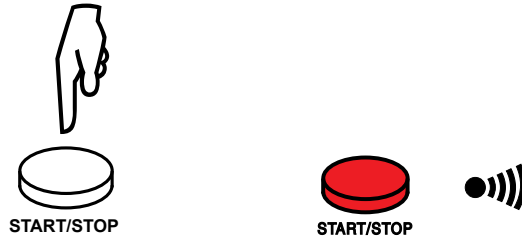

If the test voltage generated is >5000V, the **START/STOP** button blinks.

After a few seconds, the measurement is displayed in digital form and in analog form on a bargraph.

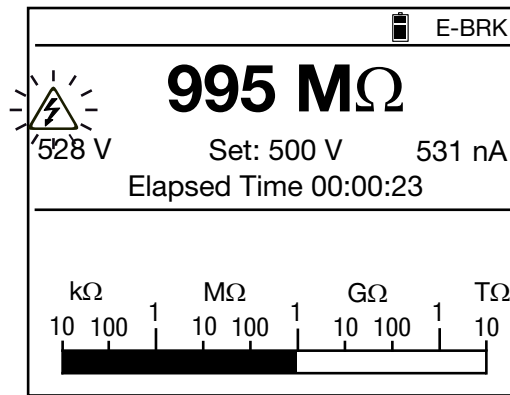

If the measurement is unstable, it is possible to apply a digital filter by pressing the **FILTER** button.

It is possible to view the available result values by pressing the **DISPLAY** button.

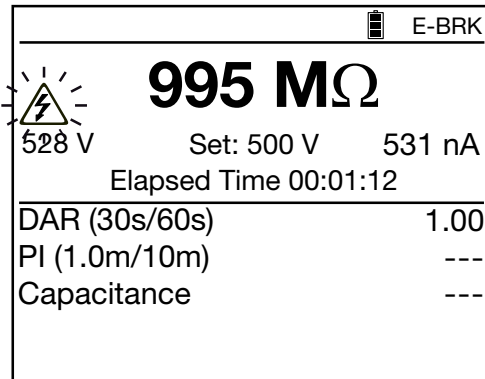
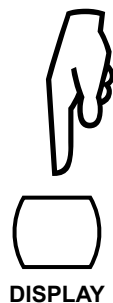

In the case of a step test voltage (10 steps at most) or ramp test voltage (3 steps), the progress of the steps will be indicated.

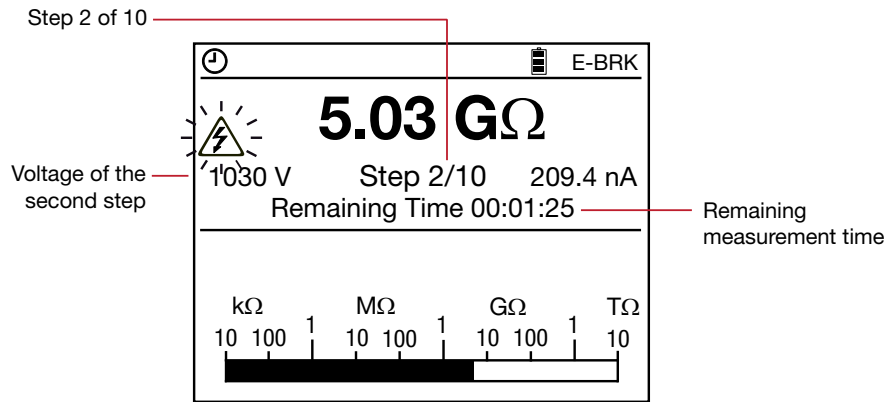

You can view the graphical representation of the measurement results by pressing the **GRAPH** button.

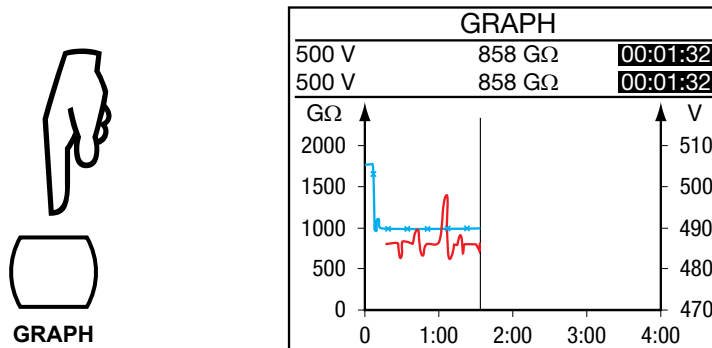

For V-VAR and V-FIXED it is also possible to change measurement parameters during the measurement, by pressing the **CONFIG** button. It is possible to fix the measurement range of the current, to add an analog filter (disturbance level low/high), or to change the test voltage if in the variable test voltage mode (V-VAR). For more details, refer to § 2.4.3.

In the case of a ramp measurement, the resistance displayed is always greater than the true resistance because of the permanent capacitive current due to the permanent variation of the voltage. The value displayed will be exact only at the end of the test, during the voltage level.

When the instrument is configured for a manual stop, once the measurement is stable, press the **START/STOP** button again to stop the measurement. In the other cases (programmed duration: Timed Run, Timed Run + DD, DAR, PI, V-RAMP, or V-STEP), the measurement stops automatically at the end of the test.

At the end of the measurement, the instrument switches back to voltage measurement, but usually the result of the insulation resistance measurement remains displayed. To display the voltage, press the **DISPLAY** button. In case of an external voltage >25V the instrument automatically switches to the screen with the test description and small input voltage indication.

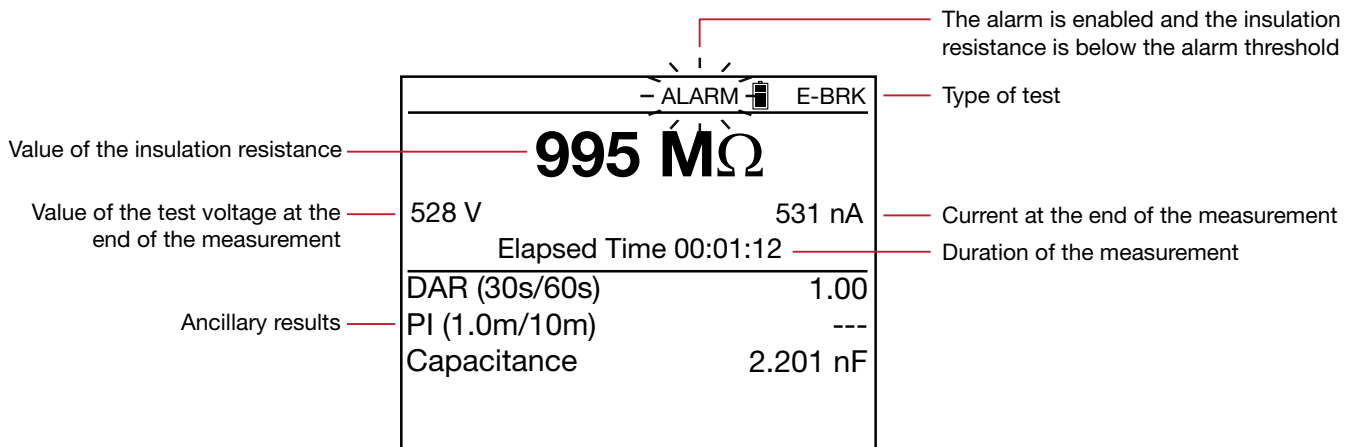

4.4.9 After the Insulation Measurement

Once the measurement has been stopped, the instrument discharges the device being tested in a few seconds. For your safety, therefore, wait before disconnecting the leads. Normally, this happens rapidly and the user is unaware of it. But if the load is highly capacitive, the discharging time is longer. In this case, for as long as the voltage exceeds 25V, the instrument indicates it on the display.

E-BRK	
995 MΩ 	
502 V	503 nA
Elapsed Time 00:01:20	
DAR (30s/60s)	1.00
PI (1.0m/10m)	---
Capacitance	<1 nF

The **DISPLAY** button is used to look up all information available after the measurement. This information depends on the type of measurement chosen (see § 2.4.4).

In the case of a ramp or step measurement, the measurement result is displayed as follows:

Test with programmed duration		E-BRK	
Value of the insulation resistance	5.03 GΩ		
Value of the test voltage at the end of the measurement	516 V	98.7 nA	Current at the end of the measurement
	Elapsed Time 00:01:40		Duration of the measurement
ΔR : difference of insulation resistance between the resistance of the highest test voltage and the resistance of the lowest test voltage	ΔR	47.9 MΩ	
	ΔV	53.3 V	
	$\Delta R/(R*\Delta V)$ (ppm/V)	9	Voltage coefficient in ppm/V
ΔV : difference between the highest and lowest test voltage	Capacitance	< 1 nF	Capacitance of the device tested

Record the measurement and compare it to earlier measurements in order to assess the evolution of its value. Also record the temperature and the ambient relative humidity.

If, at equivalent temperature and humidity, the insulation resistance has fallen significantly, the insulation is deteriorated and maintenance must be carried out on the device tested.

The result remains displayed until another measurement is made, the rotary switch is turned to a different position, or the measurement configuration is changed.

After a test with programmed duration:

- Pressing the **GRAPH** button displays the graphical representation of the results (see § 2.4.5).
- Only for V-FIXED and V-VAR: Pressing the **TEMP** button opens the temperature menu (see § 2.4.1).
- Pressing the **MEM** button opens the recording menu (see § 5.1).
- At any time, you can press the **HELP** button for a reminder of the functions of the buttons.

4.5 Error Indications

The most common error in the case of an insulation measurement is the presence of a voltage on the terminals. The instrument can make the measurement if the peak value of this voltage is less than $0.4V_N$ or 1000VAC max. Above this value, it is necessary to eliminate the voltage and repeat the measurement.

If an external voltage appears on the terminals during the measurement, and its peak value is greater than $1.1V_N$, the measurement is stopped and the error is indicated.

4.6 DAR (dielectric absorption ratio) and PI (polarization index)

For V-FIXED and V-VAR: In addition to the quantitative value of the insulation resistance, it is very useful to calculate the quality ratios of the insulation (the DAR and the PI) because they can eliminate the influence of certain parameters likely to invalidate the “absolute” insulation measurement. They also serve to predict the evolution of insulation quality over time.

The most important of the parameters influencing the measurement results are:

- temperature and relative humidity, with which insulation resistance varies according to a quasi-exponential law.
- the disturbance currents (capacitive charging current, dielectric absorption current) created by the application of the test voltage. Even if they gradually fade, they interfere with the measurement at the start, for a more or less long time depending on whether the insulation is sound or degraded.

These ratios therefore complete the “absolute” insulation value and reliably reflect the condition, good or bad, of the insulation.

In addition, long-term observation of the evolution of these ratios is a way to monitor the aging of the insulation. For example, that of a revolving machine or of a long cable.

The values of DAR and PI are calculated as follows:

- $DAR = R_{1\text{ min}}/R_{30\text{ s}}$ (2 values to be taken during a 1-min measurement)
- $PI = R_{10\text{ min}}/R_{1\text{ min}}$ (2 values to be taken during a 10-min measurement)

The times of 1 and 10 minutes for the calculation of the PI and the times of 30 seconds and 1 minute for the calculation of the DAR can be modified in the **CONFIG** menu or the **SET-UP** function (see § 3.2), to adapt to particular applications.

4.6.1 DAR/PI Measurement

There are several ways of measuring the DAR and the PI:

- **Manual Configuration:**

Press the **START/STOP** button. Wait one minute for the DAR or ten minutes for the PI (if the default values are used).

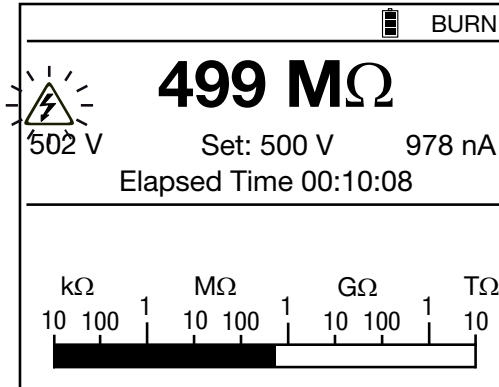

Press the **START/STOP** button again to stop the measurement.

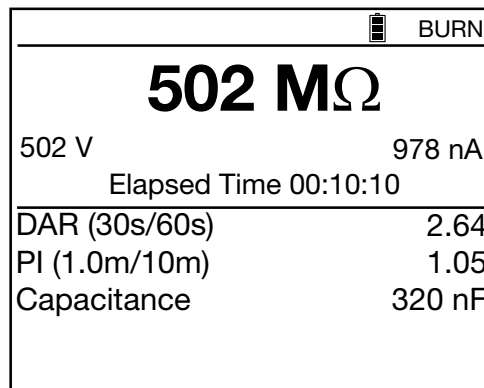

- **Automatic Configuration (preferred)**

Press the **CONFIG** button.

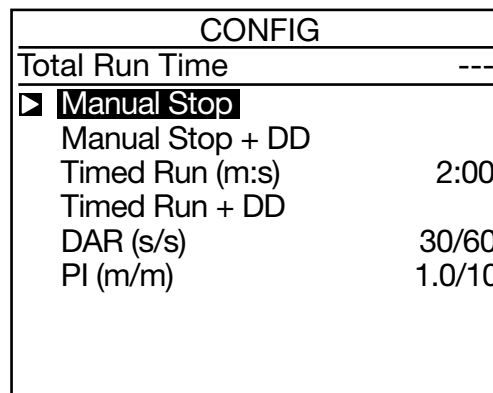

Use the ▲▼ arrow buttons to select DAR or PI.

CONFIG	
Total Run Time	00:01:00
Manual Stop	
Manual Stop + DD	
Timed Run (m:s)	2:00
Timed Run + DD	
▶ DAR (s/s)	30/60
PI (m/m)	1.0/10

CONFIG	
Total Run Time	00:10:00
Manual Stop	
Manual Stop + DD	
Timed Run (m:s)	2:00
Timed Run + DD	
DAR (s/s)	30/60
▶ PI (m/m)	1.0/10

Press the **CONFIG** button to exit the configuration menu.

DAR or **PI** is displayed in the top left corner of the display unit to indicate the configuration chosen.

Press the **START/STOP** button to start the measurement. It stops automatically and the values of DAR and PI are displayed.

4.6.2 Interpretation of the Results

DAR	PI	Condition of insulation
DAR < 1.25	PI < 1	Poor or even dangerous
	1 ≤ PI < 2	
1.25 ≤ DAR < 1.6	2 ≤ PI < 4	Good
1.6 ≤ DAR	4 ≤ PI	Excellent

A capacitance in parallel to the insulation resistance extends the settling times of the measurements. This can affect or even inhibit the measurement of DAR or PI (depending on the time set for recording the first resistance value). The table below indicates the typical values of the capacitances in parallel with the insulation resistance, making it possible to measure the DAR and the PI without changing their preset durations.

	100kΩ	1MΩ	10MΩ	100MΩ	1GΩ	10GΩ	100GΩ
500V	10μF	10μF	10μF	6μF	4μF	2μF	1μF
1000V	5μF	5μF	5μF	3μF	2μF	1μF	0.5μF
2500V	2μF	2μF	2μF	1.2μF	1μF	0.5μF	0.2μF
5000V	1μF	1μF	1μF	0.6μF	0.4μF	0.3μF	0.1μF
10,000V	0.5μF	0.5μF	0.5μF	0.3μF	0.2μF	0.1μF	0μF
15,000V	0.3μF	0.3μF	0.3μF	0.2μF	0.1μF	0.1μF	0μF

4.7 DD (dielectric discharge index)

In the case of multilayer insulation, if one of the layers is defective but the resistance of all the others is high, neither the quantitative insulation measurement nor the calculation of the PI and DAR quality ratios will reveal the problem.

This makes it judicious to perform a dielectric discharge test, from which the DD term can be calculated. This test measures the dielectric absorption of heterogeneous or multilayer insulation and disregards parallel-surface leakage currents.

The dielectric discharge test is especially well suited for measuring the insulation of revolving machines and more generally for measuring the insulation on heterogeneous or multi-layer insulating materials containing organic substances.

It involves applying a test voltage for long enough to electrically “charge” the insulation to be measured. At the end of the measurement, the instrument induces rapid discharging, during which the capacitance of the insulation is measured, then, one minute later, it measures the residual current flowing in the insulation.

The DD term is then calculated as follows:

$$DD = \text{current measured after 1 minute (mA)} / [\text{test voltage (V)} \times \text{measured capacitance (F)}]$$

4.7.1 DD Measurement

Press the **CONFIG** button.



CONFIG	
Total Run Time	---
▶ Manual Stop	
Manual Stop + DD	
Timed Run (m:s)	2:00
Timed Run + DD	
DAR (s/s)	30/60
PI (m/m)	1.0/10

Use the ▲ ▼ arrow buttons to select Manual Stop + DD or Timed Run + DD (manual or automatic measurement).

CONFIG	
Total Run Time	---
Manual Stop	
▶ Manual Stop + DD	
Timed Run (m:s)	2:00
Timed Run + DD	
DAR (s/s)	30/60
PI (m/m)	1.0/10

CONFIG	
Total Run Time	00:03:00
Manual Stop	
Manual Stop + DD	
Timed Run (m:s)	2:00
▶ Timed Run + DD	
DAR (s/s)	30/60
PI (m/m)	1.0/10

To set the duration of the measurement, place the cursor on Timed Run (m:s). Then use the ◀ ▶ and ▲ ▼ arrow buttons to set the minutes and seconds. The minimum setting is 0:01 but a duration below 30 seconds is hardly useful because acquiring a stable resistance result requires some time.

CONFIG	
Total Run Time	00:02:00
Manual Stop	
Manual Stop + DD	
▶ Timed Run (m:s)	2:00
Timed Run + DD	
DAR (s/s)	30/60
PI (m/m)	1.0/10

Once the duration has been set, move the cursor back to Timed Run + DD.

- Press the **CONFIG** button to confirm and exit the configuration menu. DD or ☉ DD is displayed in the top left corner of the display unit to indicate the configuration chosen.
- Press the **START/STOP** button to start the measurement.

In the Manual Stop + DD configuration, wait until the elapsed time is greater than one minute, then press the **START/STOP** button to stop the measurement.

In the Timed Run + DD configuration (indicated by the ☉ symbol), the measurement stops automatically.

In both cases, it is necessary to wait one minute after the measurement is stopped (countdown on the display unit) for the instrument to display the result. During this time, the **START/STOP** button is lit but the instrument does not emit an audible signal.

The result is then displayed.



☉ DD	BURN
	234.5 MΩ
507 V	224.6 pA
Elapsed Time 00:02:00	
DAR (30s/60s)	1.42
PI (1.0m/10m)	---
Capacitance	2.201 nF
DD current	11.55 pA
DD	2.55

4.7.2 Interpretation of Results

Value of DD	Quality insulation
$7 < DD$	Very poor
$4 < DD < 7$	poor
$2 < DD < 4$	Borderline
$DD < 2$	Good

4.8 Capacitance Measurement

The capacitance measurement is made automatically during the insulation measurement, and is displayed after the measurement has been stopped and the device tested has been discharged.

4.9 Measurement of the Residual Current

The measurement of the residual current flowing in the device tested is made automatically as soon as the connection to the device tested is made, then during and after the insulation measurement.

5. MEMORY FUNCTION

5.1 Recording a Measurement

Each insulation measurement can be recorded once the measurement process is completed. It is not possible to record input voltage measurements prior to starting a test.

The results are recorded at addresses identified by an object number (OBJ) and a test number (TEST).

An object can contain 99 tests. An object can represent a machine or an installation on which a certain number of measurements will be performed.

- At the end of the measurement, press the **MEM** button.
- The instrument proposes recording the result at the first available location in memory. It is possible to modify the proposed location using the ◀ ▶ and ▲ ▼ arrow buttons.

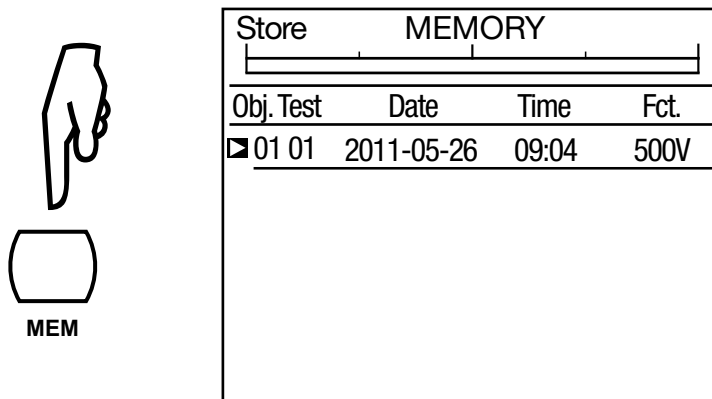

- Press the **MEM** button again to confirm the storage location.
- The instrument then asks you if you want to Store Samples with the measurement.

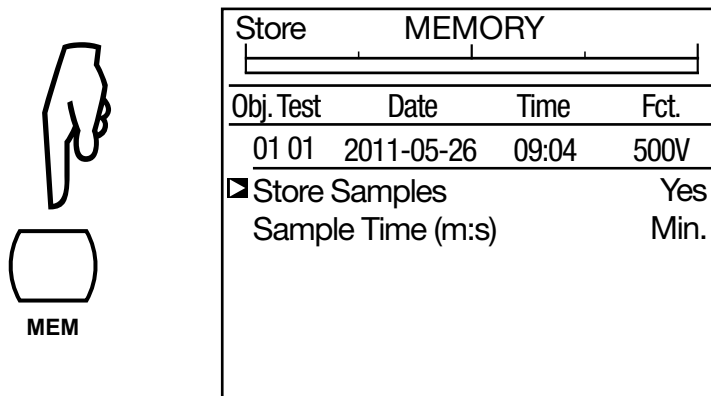

The graph of the measurement can then be displayed by a single press on the **GRAPH** button (see § 2.4.5).

If this is not required, set Store Samples to OFF.

If Store Samples are set to Yes, the Sample Time can be set using the ◀ ▶ and ▲ ▼ arrow buttons.

- The default sampling time (the time difference between two stored samples) is the minimum, meaning that all samples acquired during the measurement are recorded.

- The sampling time can be set to Auto (automatic), in which case the instrument itself determines the samples necessary for the plotting of the measurements while using the least possible memory. If the measurement does not vary, it will take only one value, giving a perfectly flat curve.
This value is recommended to optimize memory use.

The sampling time can also be programmed, between 1 and 25 seconds.

- The longer the measurement, the longer the sampling time can be. For example, on a measurement lasting 10 minutes, the sampling time can be 10 seconds, giving 60 points for the graph, which is sufficient.
- Again, the more stable the measurement, the longer the sampling time can be. The more unstable the measurement, the shorter the sampling time must be in order to correctly display variations of the insulation resistance.

Press the **MEM** button one last time to record the measurement. The instrument confirms the storage.



The measurement is recorded with all its supporting information.

To exit without recording and return to the last measurement, press the ◀ button.

For each new record, the instrument proposes the first free memory location following the last stored measurement. It is also possible to record a measurement at a memory location that has already been used.

The bargraph indicates the quantity of memory used (in black), the quantity of memory available (in white).

Obj.	Test	Date	Time	Fct.
03	01	2011-05-28	09:04	2550V
02	02	2011-05-27	10:43	<input type="checkbox"/>
02	01	2011-05-27	10:38	<input type="checkbox"/>
01	02	2011-05-26	15:04	1000V <input type="checkbox"/>
01	01	2011-05-26	14:56	500V

Measurement function and availability of samples are indicated.

The number of measurements that can be recorded depends on the number of samples stored for each measurement.

The instrument store 256 measurements and 80,000 samples associated with these measurements.

5.2 Reading Recorded Values

Turn the rotary switch to the **MR** position.

The instrument indicates the memory used and the object number of the last stored record, along with the lowest and highest test numbers it contains.

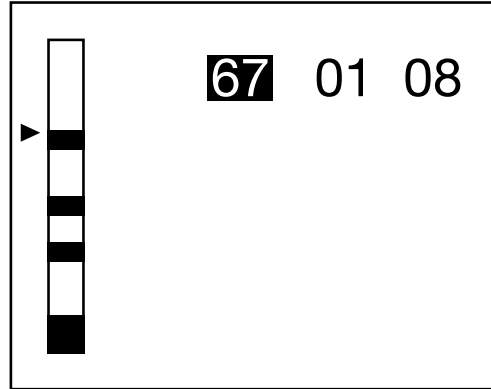
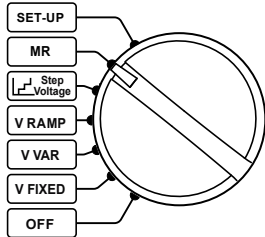

Choose the object number using the ▲ ▼ arrow buttons, then press the ► button.

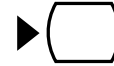

The instrument then displays the list of records around the object chosen.

To see details of a measurement, place the cursor on the object and the test chosen using the ▲ ▼ arrow buttons, then press the ► button.

Obj. Test	Date	Time	Fct.
03 01	2011-05-28	09:04	2550V
▣ 02 02	2011-05-27	10:43	⏏ □
02 01	2011-05-27	10:38	⏏
01 02	2011-05-26	15:04	1000V □
01 01	2011-05-26	14:56	500V

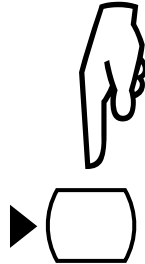



Obj. Test	Date	Time	Fct.
02 02	2011-05-27	10:43	⏏ □
Resistance		5.05 GΩ	
Voltage		965 V	
Current		190.6 nA	
Elapsed time		00:01:40	
Sample time (m:s)		0:02	

Press the **DISPLAY** button to see the rest of the recorded information (depending on the currently used function).

When the □ symbol indicates that the samples have been recorded, you can press the **GRAPH** button to view the graph.



Obj. Test	Date	Time	Fct.
02 02	2011-05-27	10:43	 
Step Function			
Step	Voltage	Duration (m:s)	
6	600 V	0:10	
7	700 V	0:10	
8	800 V	0:10	
9	900 V	0:10	
10	1000 V	0:10	

DISPLAY



Recall		MEMORY
102 V	---	TΩ
102 V	---	TΩ

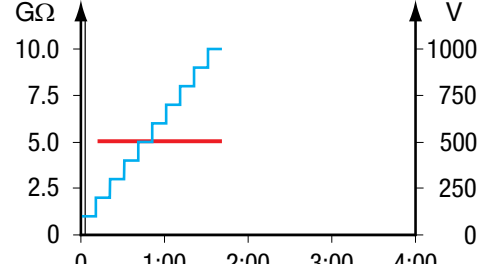

GRAPH

Press the **GRAPH** button to exit from the graph.



In the case of a V-FIXED or V-VAR measurement, you can press the **TEMP** button to view the temperature information. The instrument can display only the information recorded with the measurement.

Press the **TEMP** button, then the ◀ arrow button, to exit and return to the list of recorded measurements.



Obj. Test	Date	Time	Fct.
05 02	2011-05-27	10:43	2500V
Air Temperature		23 °C	
Humidity		40%	
Probe Temperature		23 °C	
Rc Reference Temperature		40 °C	
ΔT for R/2		10 °C	
R measured		5.00 GΩ	
Rc at 40 °C		1.529 GΩ	

TEMP

TEMP

5.3 Erasing the Memory

Turn the rotary switch to the **MR** position.

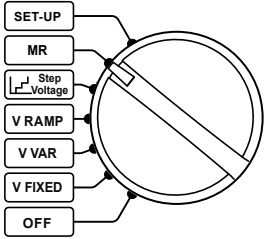

5.3.1 Erasing One Record

With an object selected, use the ▲▼ arrow buttons to select the record to be erased in the list of records in memory.

Press the **CONFIG** button. The instrument requests confirmation of the deletion.

Obj.	Test	Date	Time	Fct.
03	01	2011-05-28	09:04	2550V
02	02	2011-05-27	10:43	<input type="checkbox"/>
02	01	2011-05-27	10:38	<input type="checkbox"/>
01	02	2011-05-26	15:04	1000V <input type="checkbox"/>
01	01	2011-05-26	14:56	500V

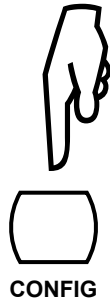

Select **OK** to confirm or **CANCEL** to cancel. The instrument then returns to the top level memory screen.

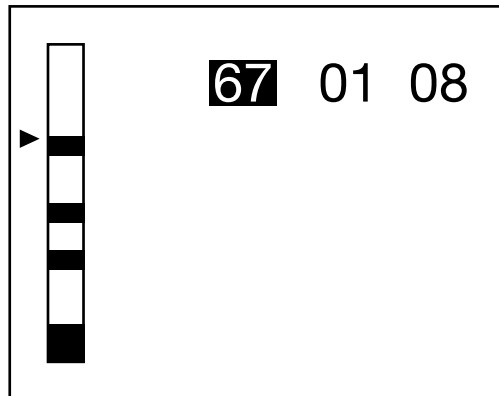

NOTE: Deleting a single record doesn't delete it physically - only the link to it is deleted. The record number can be used again for storing another measurement. Physical clearing of data is only accomplished when clearing the whole memory.

5.3.2 Erasing All Records

Press the **CONFIG** button. The instrument requests confirmation of the deletion.

Select **OK** to confirm or **CANCEL** to cancel.

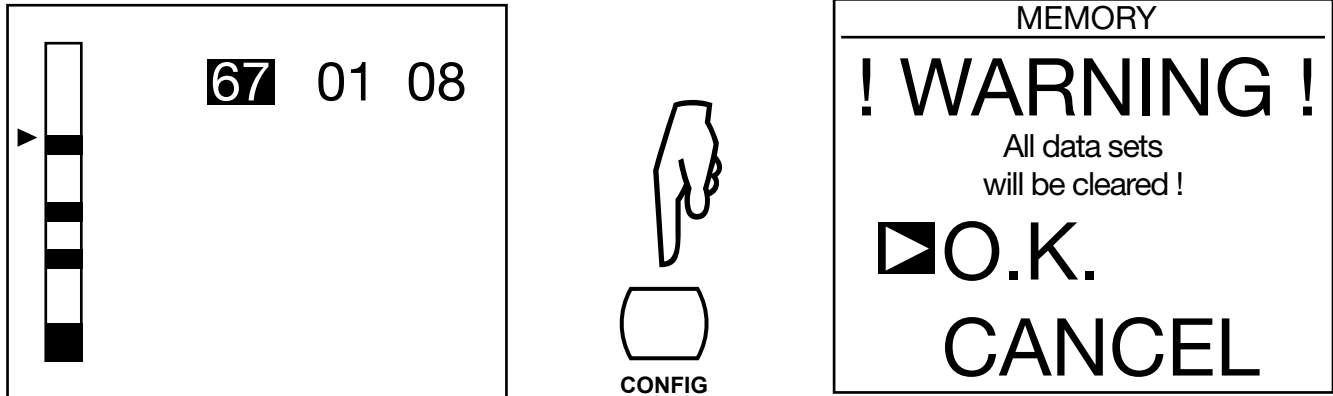

The instrument in this case completely reformats the memory, which takes a few minutes. During this time, it displays “**WAIT**”.

The instrument then returns to the top level memory screen. Since there is no longer any record, it displays:



5.4 Error Codes

If an anomaly is detected when the instrument is turned on or in operation, the display indicates a one- or two-digit number error code. This number identifies the anomaly and states what to do to put the instrument back into service.

- Errors 1 to 9 concern internal circuit board problems and require a repair by a qualified individual.
- Error codes 20 to 25 help the repair personnel locate a malfunction
- If the recorded data is corrupted, the only way possible to reuse the memory is to erase it completely (see § 5.3.2). The instrument reports this problem by displaying “**CLEAR MEMORY**”.
- All other errors require returning the instrument for repair (see § 8.5).

6. DATAVIEW® SOFTWARE

 For complete information on using the Megohmmeter with DataView, refer to the Help Menu within the Megohmmeter Control Panel in DataView.

6.1 Installing DataView

DataView® is a registered trademark of Chauvin Arnoux® d.b.a. AEMC® Instruments.

 **DO NOT CONNECT THE INSTRUMENT TO THE PC BEFORE INSTALLING THE SOFTWARE AND DRIVERS.**

Minimum Computer Requirements:

- Windows XP / Windows Vista & Windows 7/8 (32/64 bit)
- 256MB of RAM for Windows XP
1GB of RAM for Windows Vista & Windows 7/8 (32 bit)
2GB or RAM for Windows Vista & Windows 7/8 (64 bit)
- 80MB of hard disk space (200MB recommended)
- USB port

Windows® is a registered trademark of Microsoft Corporation in the United States and other countries.

USB Flash Drive Install

1. Insert the USB drive into an available USB port (wait for driver to be installed).
2. If Autorun is enabled then an AutoPlay window should appear as shown.

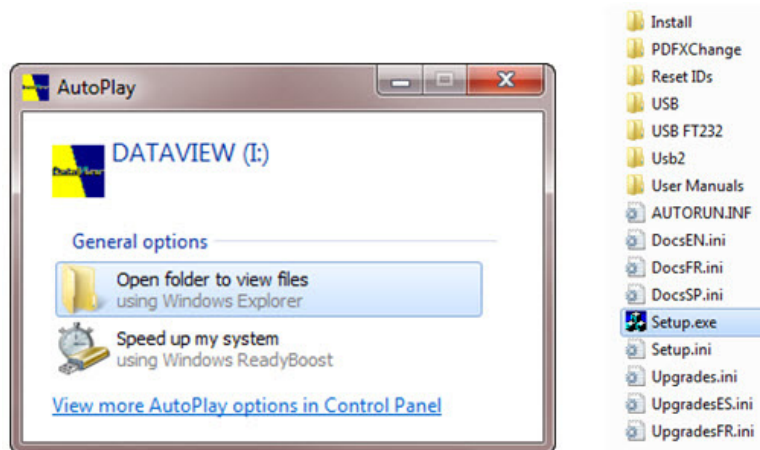



Figure 1

 **NOTE:** If Autorun is disabled, it will be necessary to open Windows Explorer, then locate and open the USB removable disk drive labeled “DataView” to view the files on the drive.

3. In the AutoPlay window, select “Open folder to view files”.
4. Double-click on Setup.exe from the opened folder view to launch the DataView setup program.

 If installing onto a Vista based computer the **User Account Control** dialog box will be displayed. Select the **Allow** option to proceed.

2. A **Set-up** window, similar to the one below, will appear.

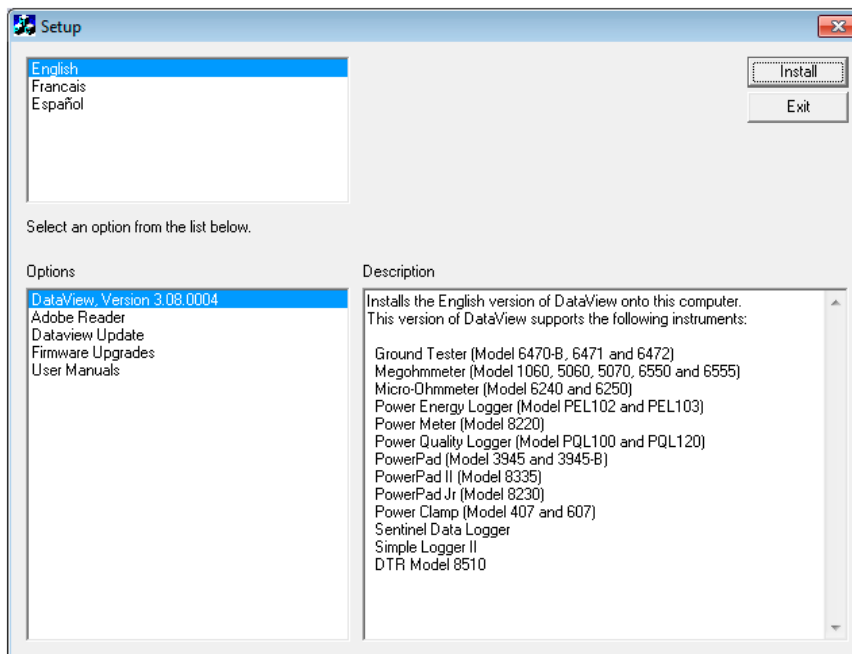

Figure 6-1

There are several different options to choose from. Some options(*) require an internet connection.

- **DataView, Version x.xx.xxxx** - Installs DataView onto the PC.
 - ***Adobe Reader** - Links to the Adobe® website to download the most recent version of Adobe® Reader to the computer. Adobe® Reader is required for viewing PDF documents supplied with DataView.
 - ***DataView Updates** - Links to the online DataView software updates to check for new software version releases.
 - ***Firmware Upgrades** - Links to the online firmware updates to check for new firmware version releases.
 - **Documents** - Shows a list of instrument related documents that you can view. Adobe® Reader is required for viewing PDF documents supplied with DataView.
3. **DataView, Version x.xx.xxxx** option should be selected by default. Select the desired language and then click on **Install**.
 4. The **Installation Wizard** window will appear. Click **Next**.
 5. To proceed, accept the terms of the license agreement and click **Next**.
 6. In the **Customer Information** window, enter a Name and Company, then click **Next**.
 7. In the **Setup Type** window that appears, select the “Complete” radio button option, then click **Next**.
 8. In the **Select Features** window that appears, select only the instrument’s control panel that you want to install, then click **Next**.



The **PDF-XChange** option must be selected to be able to generate PDF reports from within DataView.

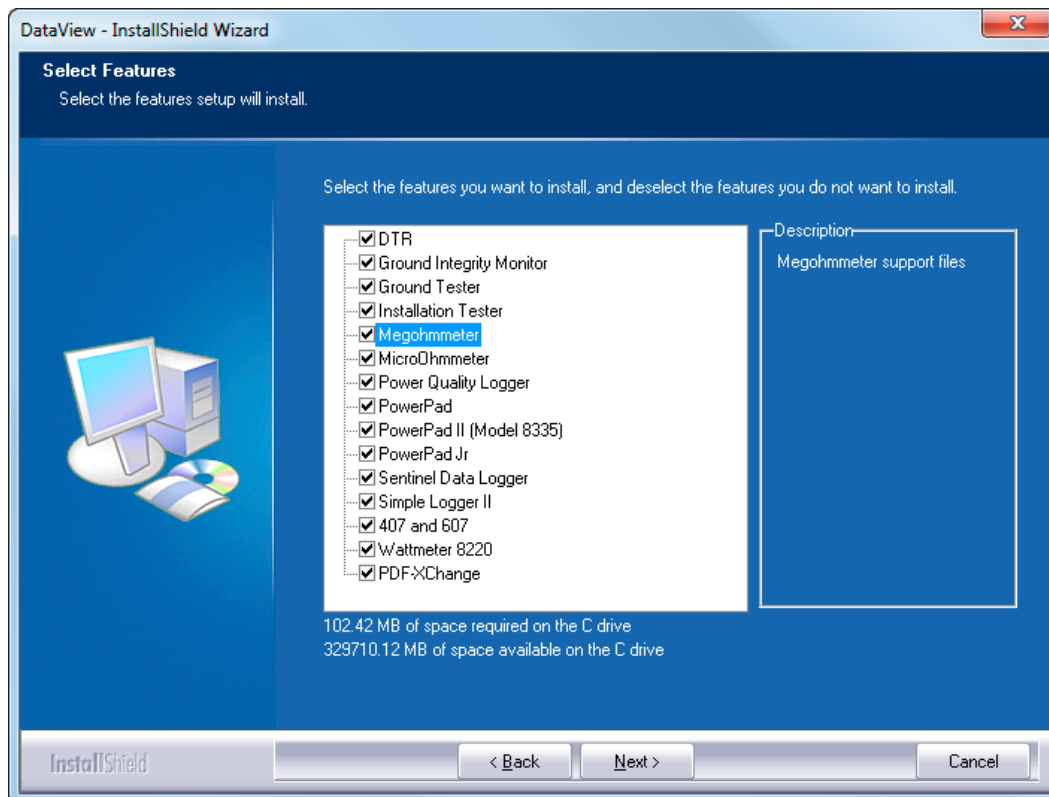

Figure 6-2

9. In the **Ready to Install the Program** window, click on **Install**.
10. If the instrument selected for installation requires the use of a USB port, a warning box will appear, similar to below. Click **OK**.

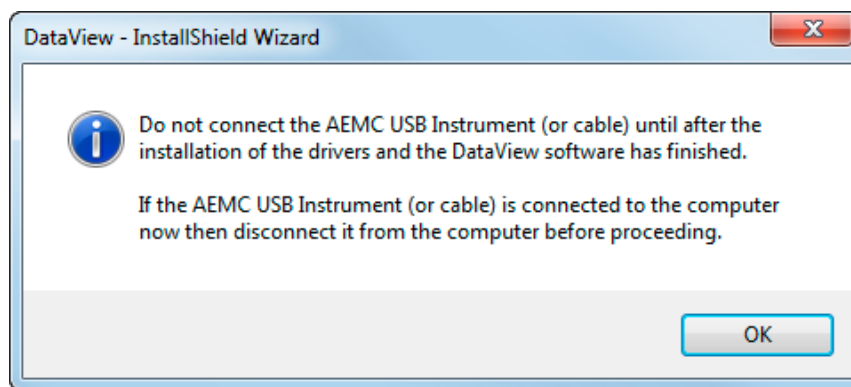



Figure 6-3

 The installation of the drivers may take a few moments. Windows may even indicate that it is not responding, however it is running. Please wait for it to finish.

11. When the drivers are finished installing, the **Installation Successful** dialog box will appear. Click on **OK**.
12. Next, the **Installation Wizard Complete** window will appear. Click on **Finish**.
13. A **Question** dialog box appears next. Click **Yes** to read the procedure for connecting the instrument to the USB port on the computer.

 The Set-up window remains open. You may now select another option to download (e.g. Adobe® Reader), or close the window.

14. **Restart** your computer.

Shortcuts for DataView and each instrument control panel selected during the installation process have been added to your desktop.

You can now open the Megohmmeter Control Panel and connect your instrument to the computer.



6.2 Connecting the Instrument to the PC

INSTALL THE SOFTWARE AND DRIVERS BEFORE CONNECTING THE INSTRUMENT TO A PC.

- Set the switch to any position other than OFF.
- The data rate must be 38,400 bauds for the instrument (see §5.2) and for the PC.
- Connect the instrument to the PC using the optical USB cable supplied with the instrument, after removing the cover that protects the port in the instrument.

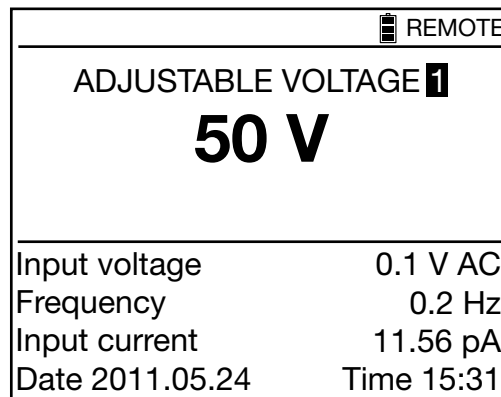
When in communication with a PC, the instrument displays “**REMOTE**” and no longer reacts to the user’s commands. The buttons and the rotary switch are inactive, except for stopping the instrument (OFF setting).



 REMOTE	
ADJUSTABLE VOLTAGE 	
50 V	
Input voltage	0.1 V AC
Frequency	0.2 Hz
Input current	11.56 pA
Date 2011.05.24	Time 15:31

6.3 Megohmmeter Control Panel

6.3.1 Opening the Control Panel

To open the Megohmmeter Control Panel:

- Double-click the **Megohmmeter icon** that was created during installation, located on the desktop.
- The **Megohmmeter Control Panel** window will appear.

 For complete information on using the Megohmmeter with DataView, refer to the Help Menu within the Megohmmeter Control Panel in DataView.

7. SPECIFICATIONS

7.1 Reference Conditions

Influence Quantities	Reference values
Temperature	23 ± 3°C
Relative Humidity	45 to 55% RH
Supply Voltage	9 to 12V
Frequency Range	DC and 15.3 to 65Hz
Capacitance in Parallel on Resistance	0μF
Electric Field	null
Magnetic Field	<40A/m

The inherent accuracy is the error specified for the reference conditions.

The operating accuracy includes the inherent uncertainty plus variations of the quantities of influence (supply voltage, temperature, interference, etc.) as defined in standard IEC-61557.

7.2 Electrical Specifications

7.2.1 Voltage

Measurement Range	1.0 to 99.9V	100 to 999V	1000 to 2500V	2501 to 4000V
Resolution	0.1V	1V	2V	2V
Accuracy	±(1% +5cts)	±(1% +1ct)		
Frequency range	DC or 15 to 500Hz			DC

- Input impedance: 3MΩ

7.2.2 Current

Measurement Range (DC)	0.000 to 0.399nA	0.400 to 3.999nA	4.00 to 39.99nA	40.0 to 399.9nA	400 nA to 3.999μA
Resolution	1pA	1pA	10pA	100pA	1nA
Accuracy	±(15% + 10cts)	±10%	±5%		

Measurement Range (DC)	4.00 to 39.99μA	40.0 to 399.9μA	400 μA to 3.999mA	4.00 to 9.999mA
Resolution	10nA	100nA	1μA	10μA
Accuracy	±5%			

7.2.3 Insulation Resistance

- **Method:** Voltage-current measurement per IEC-61557-2 from 300 to 10,000V and per DIN VDE 0413 Part 1/09.80)
- **Nominal output voltage:** 500V, 1000V, 2500V, 5000V, 10,000V, and 15,000VDC for the Model 6555 or adjustable from 40 to 10,000VDC and 15,000VDC for the Model 6555
Inherent accuracy $\pm 1\%$
adjustable from 40 to 10,000VDC in 10-V steps
adjustable from 1000 to 15,000VDC in 100-V steps
- **Maximum current:** $\leq 1\text{mADC}$ from 40 to 999V
5 to 0.2mADC from 1000 to 15,000V. The user can adjust this current.
- **Maximum acceptable peak AC voltage at terminals during measurement:**
0.4VN or 1000VAC maximum
- **Short-circuit current:** $\leq 5\text{mADC} \pm 5\%$. This current can be limited in **SET-UP** (setting “maximum output current”), to between 0.2 and 5mA. It can also be limited by the maximum output power, which is 10W.
- **Maximum output current as a function of the test voltage**

U_N (V)	50	100	200	300	1100	1200	1300	5000	10,000	15,000
I (mA)	0.22	0.46	0.93	1.07	1.07	5	5	2	1	0.5
P (W)	≤ 1					10				

If the current is limited in **SET-UP**, the values mentioned above that exceed the limit will be lowered.

■ Fixed Test Voltage

Test Voltage (V)	500 - 1000 - 2500 - 5000 - 10,000 - 15,000				
Specified measurement range	10 to 999k Ω 1.000 to 3.999M Ω	4.00 to 39.99M Ω	40.0 to 399.9M Ω	400 to 3.999G Ω	4.00 to 39.99G Ω
Resolution	1k Ω	10k Ω	100k Ω	1M Ω	10M Ω
Accuracy	$\pm(5\% + 3\text{cts})$				
Operating error	$\pm(10\% + 6\text{cts})$				

Test Voltage (V)	500 - 1000 - 2500 - 5000 10,000 - 15,000		≥ 1000	≥ 2500	≥ 5000
Specified measurement range	40.0 to 399.9G Ω	400 to 999G Ω 1.000 to 1.999T Ω	2.000 to 3.999T Ω	4.00 to 10.00T Ω	4.00 to 15.00T Ω
Resolution	100M Ω	1G Ω	1G Ω	10G Ω	10G Ω
Accuracy	$\pm(15\% + 10\text{cts})$				$\pm(20\% + 10\text{cts})$
Operating error	$\pm(20\% + 15\text{cts})$	$\pm(30\% + 15\text{cts})$			

Test Voltage (V)	$\geq 10,000$	15,000 (6555 only)
Specified measurement range	4.00 to 25.00T Ω	4.00 to 29.00T Ω
Resolution	10G Ω	10G Ω
Inherent accuracy	$\pm(20\% + 10\text{cts})$	$\pm(20\% + 10\text{cts})$
Operating error	$\pm(30\% + 15\text{cts})$	

■ **Variable test voltage**

Minimum resistance measured = $10k\Omega$

Maximum resistance measured = to be interpolated from the values in the tables of fixed test voltages above.

The inherent uncertainty depends on the test voltage and on the resistance measured. It can be interpolated from the tables of fixed test voltages.

■ **Typical discharge time of a capacitive element to reach 25 Vdc**

Test Voltage	50V	100V	250V	500V	1000V	2500V
Discharge Time (C at μF)	$0.25 s \times C$	$0.5 s \times C$	$1 s \times C$	$2 s \times C$	$4 s \times C$	$7 s \times C$

Test Voltage	5000V	10,000V	15,000V
Discharge Time (C at μF)	$14 s \times C$	$27 s \times C$	$57 s \times C$

■ **Typical curves of the test voltages at the instrument terminals as a function of the load resistance**

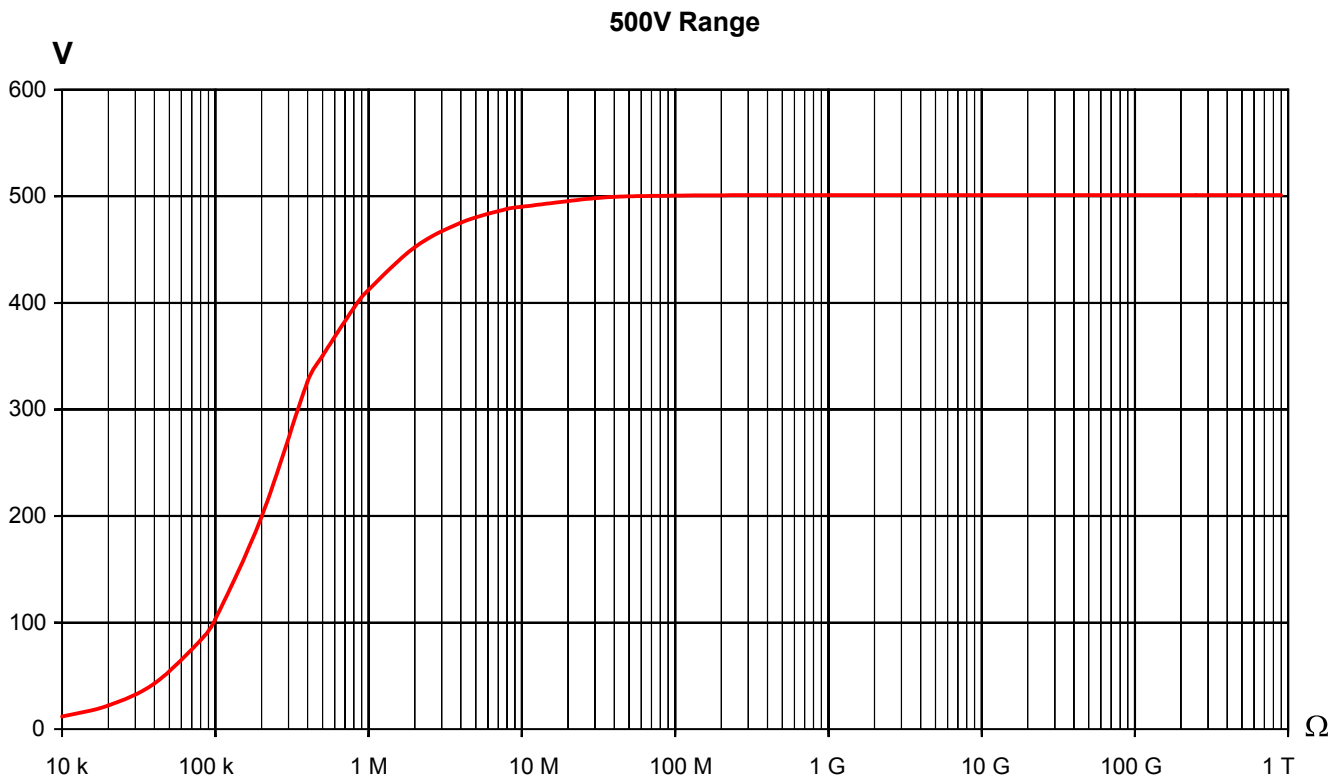

1000V Range

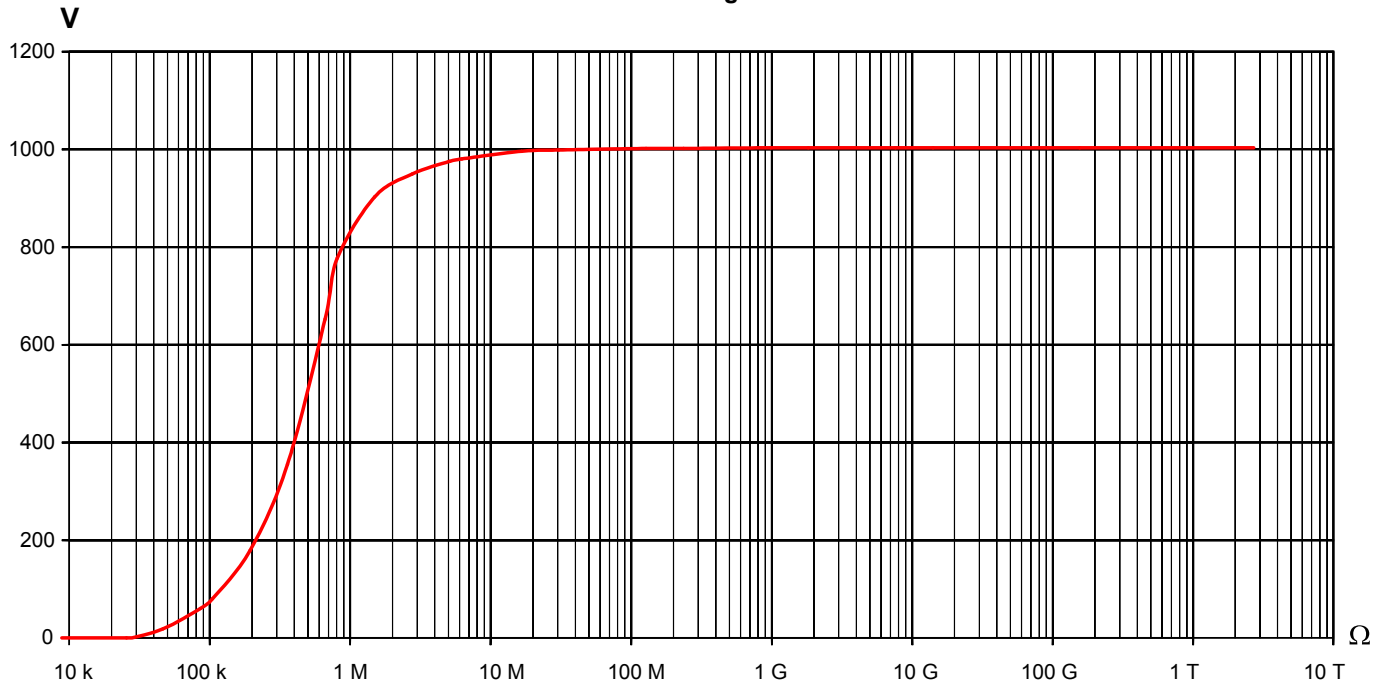

2500V Range

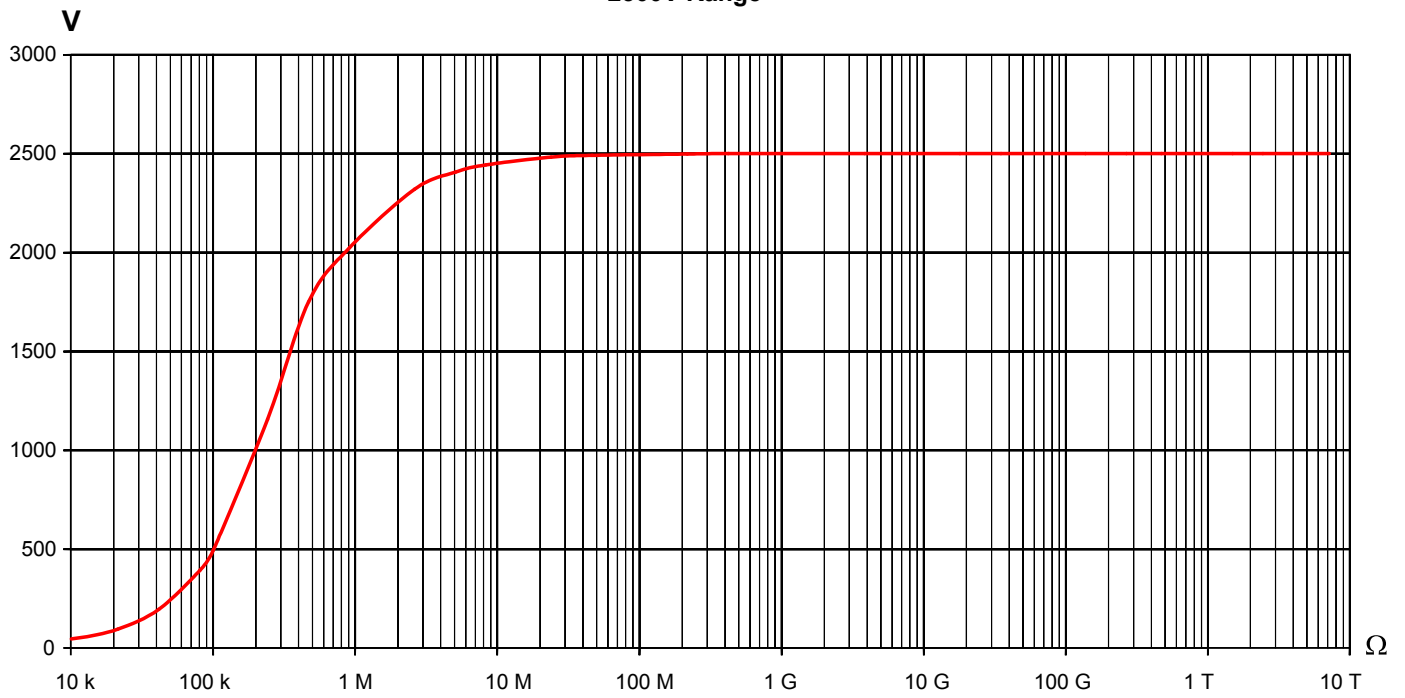

5000V Range

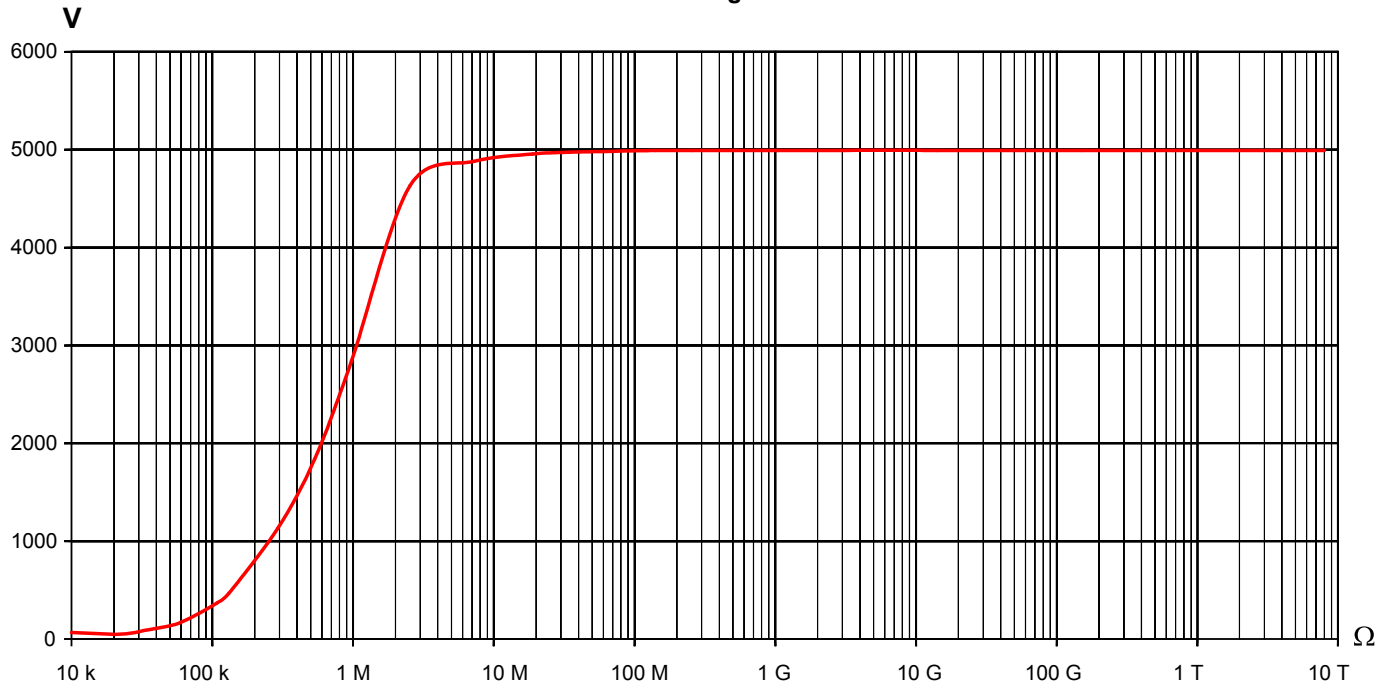

10,000V Range

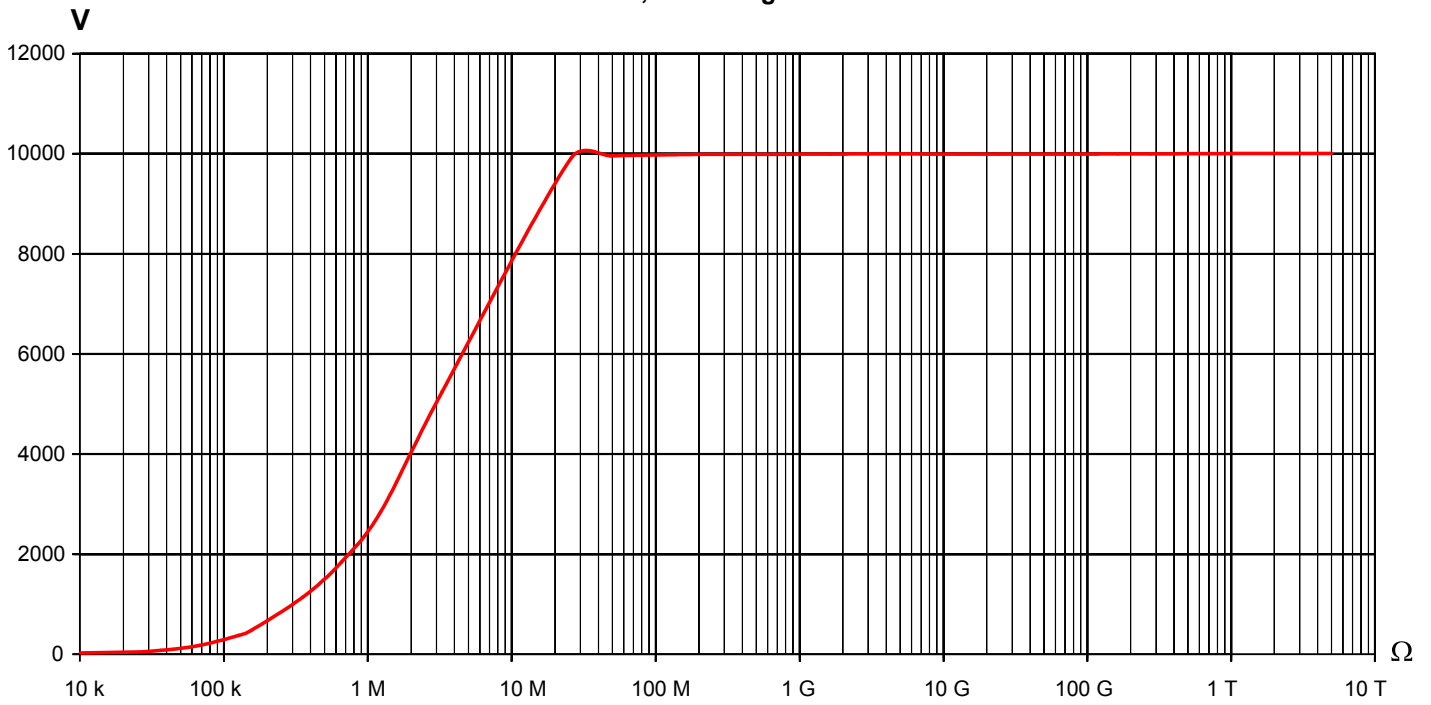

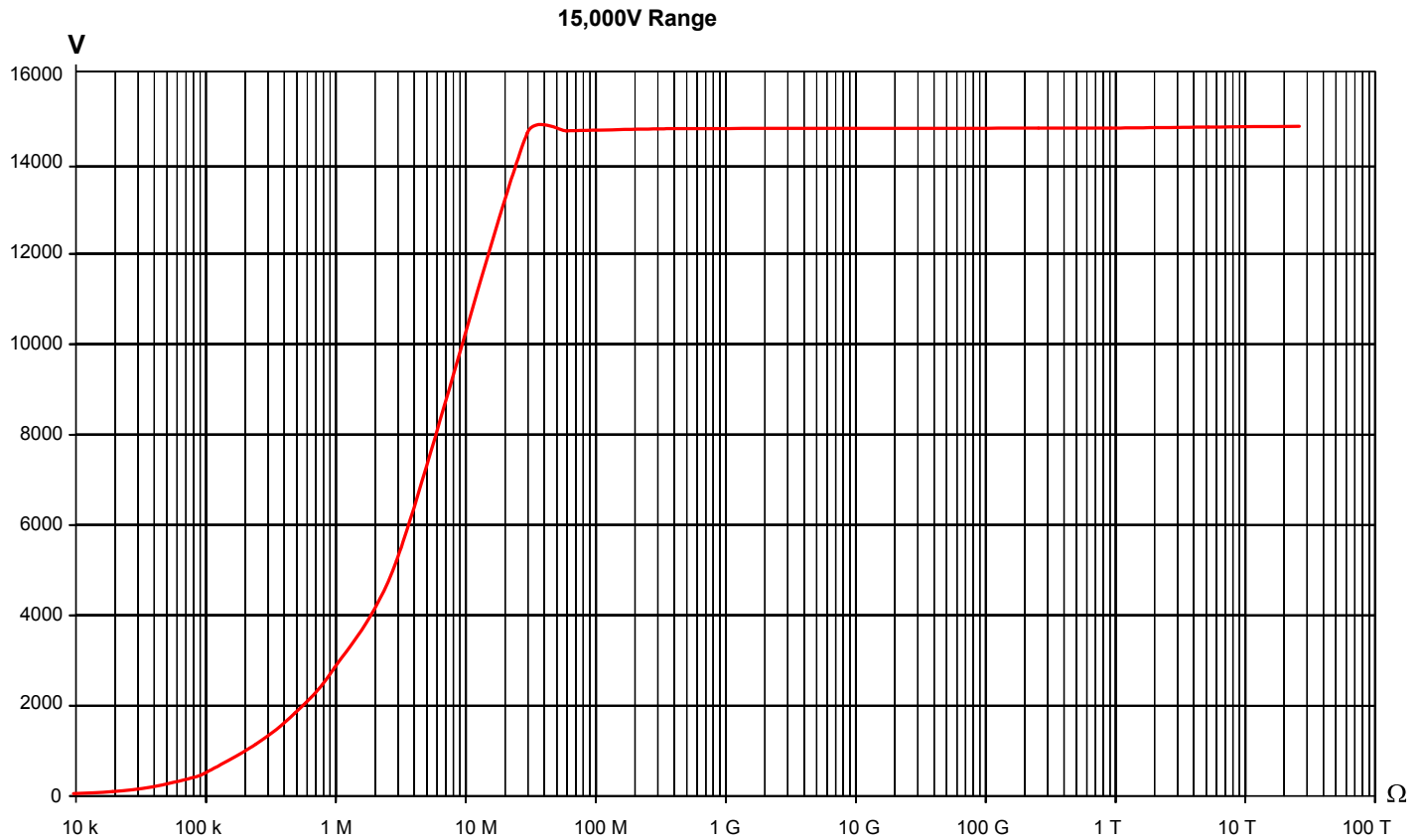

7.2.4 DAR, PI, and DD

■ Calculation of the DAR and PI terms

Measurement Range	0.02 to 50.00
Resolution	0.01
Accuracy	± (5% + 1ct)

■ Calculation of the DD term

Measurement Range	0.02 to 50.00
Resolution	0.01
Accuracy	±(10% + 1ct)

7.2.5 Capacitance

Capacitance measurement

This measurement is made following the discharging of the element tested, after each measurement

Measurement Range	0.005 to 9.999μF	10.00 to 49.99μF
Resolution	1nF	10nF
Accuracy*	± (10% + 1 ct)	± 10%

*specified only for a test voltage $\geq 500V$

7.3 Power Supply

The instrument is powered by two rechargeable 9.6V, 4Ah NiMH battery packs.

Charging is carried out by connecting the instrument to line voltage of 90 to 260V and a frequency of 50/60 Hz, with an ambient temperature of 32° to 86°F (0° to 30°C).

7.3.1 NiMH Technology

The NiMH technology has many advantages, such as:

- long life between charges with limited bulk and weight
- recharging capability
- a very small memory effect: you can recharge your battery even if it is not fully discharged, without reducing its capacity
- environmental protection through the elimination of polluting materials such as lead and cadmium

The NiMH technology allows a limited number of charging/discharging cycles that depends on the conditions of use and the charging conditions. Under optimum conditions, this number of cycles is 200.

7.3.2 Battery Charger

The built-in charger manages the charging current, the battery voltage, and the internal temperature of the battery simultaneously. This optimizes the charging, while ensuring a long battery life.

The day before you use your device, check its charge condition. If the battery level indicator shows less than three bars, charge the device overnight (see §4.1).

The charging time varies between 6h and 10h.

A half-hour charge restores 10% of the capacity of the battery, enough to make a few measurements.

It is possible to recharge the batteries while making insulation measurements, provided that the voltages used are not too high and the measured values are high enough. In this case, the recharging time will exceed 6 hours; it will depend on the frequency of the measurements made. Otherwise, the battery will be discharged faster than it is charged.

In order to extend the life of your battery:

- charge your device only between 10° and 30°C
- observe the conditions of use and storage stated in this manual

A new battery becomes fully effective only after several complete charging/discharging cycles. This will not however prevent you from using your device when it has been charged for the first time. However, we recommend making the first charge a full charge (at least 10 hours).

If the instrument indicates that charging is over, do not hesitate to disconnect the charger for a few seconds, then reconnect it to top up the charge.

The battery in your instrument, like any rechargeable battery, is subject to significant residual discharging, even when the instrument is off. If your device has not been used for several weeks, it is probable that the battery will be partially discharged, even if it had been fully recharged just before going into storage.

In this case, before using it again, you should fully recharge the battery (at least 10 hours).

The longer your battery is stored, the more it is discharged. After three months' storage of the battery without periodic recharging, the battery is probably fully discharged.

Possible consequences are:

- Failure of the instrument to switch on, as long as the power cord is not connected.
- A loss of the instrument's date and time.

7.3.3 Optimize Battery Charging

During charging, the temperature of the battery rises substantially, especially towards the end. A safety device, built into the battery, checks constantly that the battery temperature does not exceed an acceptable maximum. If this maximum is exceeded, the charger switches off automatically, even if charging is not complete.

Above 86°F (30°C), it is not possible to charge the battery fully because the charging will cause overheating.

7.3.4 Battery Life

The mean battery life depends on the measurement and on how the device is used.

Test Voltage (V)	500	1000	2500	5000	10,000	15,000	Voltmeter
Battery Life (h)	15	12	2	2	2	2	25

How long your device can operate when the battery is fully charged depends on several factors:

- The consumption of the device, which depends on the measurements you make.
- The capacity of the battery is greatest when the battery is new, and declines as the battery ages.

Here are a few ways to extend battery life between charges:

- Use the back-lighting only when it is strictly necessary.
- Set the brightness of the back-lighting to the lowest level at which you can still read the display unit.
- Enable the Auto Power OFF function (see **SET-UP** § 3.2).
- During insulation measurements conducted in MANUAL mode, with high test voltages, stop the measurement by pressing the **START/STOP** button when the measurement is complete.

7.3.5 “Defect” message

When a battery is deeply discharged or its storage temperature is low, the charger may execute a reactivation stage prior to fast charge. That means that the charger applies a slow charge until the battery reaches either a minimum temperature threshold or a minimum charge voltage threshold.

If the battery is in good condition, this reactivation stage ends after about 45 minutes then charger switches over to fast charging.

However, if the maximum time allowed for the reactivation stage is exceeded or the internal resistance of a battery at the end of its life is high, the instrument declares the battery defective in the form of a “**Defect**” message on the instrument screen.

The instrument must then be sent in for repair (see § 8.5).

7.4 Environmental Specifications

■ Range of use

The relative humidity can significantly affect insulation. Take care not to make an insulation resistance measurement if the temperature is below the dew point.

32° to 113°F (0° to 45°C); 0 to 90% RH

■ Specified domain of use

32° to 95°F (0° to 35°C); 0 to 75% RH

■ Storage (without the batteries)

-40° to 158°F (-40° to 70°C); 10 to 90% RH

■ Altitude: <2000m

■ Degree of pollution: 2

7.5 Mechanical Specifications

■ Dimensions: (LxWxH): 13.4 x 11.8 x 7.9" (340 x 300 x 200mm)

■ Weight: approximately 13.7 lb (6.2kg)

7.6 Safety Specifications

■ Electrical safety per: IEC-61010-1, IEC-61557 parts 1 and 2 (up to 10kV) or VDE 0413

■ Double insulation

■ Degree of pollution: 2

■ Voltage measurement category: 1000V CAT IV or 2500V CAT I

■ Maximum voltage with respect to earth: 1000Vrms CAT IV

■ Maximum voltage between guard terminal G and the - terminal: 30Vrms

7.6.1 Electromagnetic Compatibility

Emissions and immunity in an industrial environment per IEC-61326-1.

7.6.2 Mechanical Protections

IP 65 according to IEC-60529 with the housing closed and IP 54 with the housing open.

IK 04 according to IEC-50102.

7.7 Variations in the Domain of Use

Influence quantity	Range of influence	Quantity influenced ⁽¹⁾	Influence	
			Typical	Maximum
Battery voltage	9 to 12V	V MΩ	< 1ct < 1ct	2cts 3cts
Temperature	-10 to +55°C	V MΩ - GΩ U > 7.5kV and R < 10TΩ	±0.15%/10°C ±0.2%/10°C ±1.5%/10°C	±(0,3%/10°C + 1ct) ±(1%/10°C + 2cts) ±(3%/10°C + 2cts)
Humidity	10 to 75% RH with t ≤ 35°C	V MΩ (10kΩ to 40GΩ) MΩ (40GΩ to 10TΩ) U > 7.5 kV and 3TΩ < R < 10TΩ	±0.2% ±0.2% ±0.3% ±(15% + 5cts)	±(1% + 2cts) ±(1% + 5cts) ±(15% + 5cts) ±(30% + 5cts)
Frequency	15 to 500Hz	V	±3%	±(0.5% + 1ct)
AC voltage superimposed on test voltage	0 to 20%Vn	MΩ	±0.1%/Vn	±(0.5%/Vn + 5cts)

(1): The DAR, PI and DD terms and the capacitance and leakage current measurements are included in the quantity "MΩ".

7.8 Inherent and Operating Accuracy

The Megohmmeter Models 6550 and 6555 comply with standard IEC-61557, which requires that the operating accuracy, called B, be less than 30%.

In insulation measurements, $B = \pm (|A| + 1,15 \sqrt{E1^2 + E2^2 + E3^2})$

with A = inherent accuracy

E1 = influence of the reference position ±90°

E2 = influence of the supply voltage within the limits indicated by the manufacturer

E3 = influence of the temperature between 0° and 35°C

Specifications are subject to change without notice.

8. MAINTENANCE

8.1 Recharging the Battery

Refer § 4.1 for full details on recharging the battery.

The Megohmmeter Model 6550/6555 is equipped with a rechargeable NiMH battery. This technology offers several advantages:

- Long battery charge life for a limited volume and weight
- Possibility of quickly recharging your battery
- Significantly reduced memory effect: you can recharge your battery even if it is not fully discharged
- Environmental protection through the elimination of polluting materials such as lead and cadmium

After prolonged storage, the battery may be completely discharged. If so, it must be completely recharged.

Your instrument may not function during part of this recharging operation.

Full recharging of a completely discharged battery may take several hours.

 In this case, at least 5 charge/discharge cycles will be necessary for your battery to recover 95% of its capacity.

To make the best possible use of your battery and extend its effective service life:

- Only charge your instrument at temperatures between 32° and 86°F (0° and 30°C)
- Comply with the conditions of use defined in the operating manual
- Comply with the storage conditions specified in the operating manual

 Before first use, charge and discharge the instrument one or two cycles to ensure the proper level display of the battery indicator.

8.2 Replacing the Battery

The batteries can be replaced only by the manufacturer's service center or by an approved repair center.

 **WARNING:** Replacing the battery may result in the loss of the stored data. Back up all stored data before sending the instrument in for repair.

To return the instrument for battery replacement see § 8.5.

When the repaired instrument is returned:

- Erase the memory completely (see § 5.3.2) to be able to use the MEM/MR functions again
- If necessary, reset the date and time of the instrument (see § 3.2)
- Fully recharge the battery

AEMC® will not be held responsible for any accident, incident, or malfunction following a repair done other than by its service center or by an approved repair center.

8.3 Replacing the Fuse

If the GUARD FUSE message appears on the display unit, the guard terminal fuse must be replaced.

The fuse can be replaced only by competent, accredited personnel.

8.4 Cleaning



Disconnect the instrument from any source of electricity.

- Use a soft cloth, lightly dampened with soapy water
- Wipe with a damp cloth and then dry with a dry cloth
- Do not splash water directly on the clamp
- Do not use alcohol, solvents or hydrocarbons

8.5 Repair and Calibration

To ensure that your instrument meets factory specifications, we recommend that it be scheduled back to our factory Service Center at one-year intervals for recalibration, or as required by other standards or internal procedures.

For instrument repair and calibration:

You must contact our Service Center for a Customer Service Authorization Number (CSA#). This will ensure that when your instrument arrives, it will be tracked and processed promptly. Please write the CSA# on the outside of the shipping container. If the instrument is returned for calibration, we need to know if you want a standard calibration, or a calibration traceable to N.I.S.T. (Includes calibration certificate plus recorded calibration data).

Ship To: **Chauvin Arnoux[®], Inc. d.b.a. AEMC[®] Instruments**
15 Faraday Drive
Dover, NH 03820 USA
Phone: (800) 945-2362 (Ext. 360)
(603) 749-6434 (Ext. 360)
Fax: (603) 742-2346 or (603) 749-6309
E-mail: repair@aemc.com

(Or contact your authorized distributor)

Costs for repair, standard calibration, and calibration traceable to N.I.S.T. are available.

NOTE: You must obtain a **CSA#** before returning any instrument.

8.6 Technical and Sales Assistance

If you are experiencing any technical problems, or require any assistance with the proper operation or application of your instrument, please call, fax or e-mail our technical support team:

Chauvin Arnoux®, Inc. d.b.a. AEMC® Instruments

Phone: (800) 343-1391

(508) 698-2115

Fax: (508) 698-2118

E-mail: techsupport@aemc.com

8.7 Limited Warranty

The Models 6550/6555 are warranted to the owner for a period of one year from the date of original purchase against defects in manufacture. This limited warranty is given by AEMC® Instruments, not by the distributor from whom it was purchased. This warranty is void if the unit has been tampered with, abused or if the defect is related to service not performed by AEMC® Instruments.

Full warranty coverage and product registration is available on our website at:

www.aemc.com/warranty.html.

Please print the online Warranty Coverage Information for your records.

What AEMC® Instruments will do:

If a malfunction occurs within the one-year period, you may return the instrument to us for repair, provided we have your warranty registration information on file or a proof of purchase. AEMC® Instruments will, at its option, repair or replace the faulty material.

REGISTER YOUR PRODUCT ONLINE AT: www.aemc.com

8.8 Warranty Repairs

What you must do to return an Instrument for Warranty Repair:

First, request a Customer Service Authorization Number (CSA#) by phone or by fax from our Service Department (see address below), then return the instrument along with the signed CSA Form. Please write the CSA# on the outside of the shipping container. Return the instrument, postage or shipment pre-paid to:

Ship To: **Chauvin Arnoux®, Inc. d.b.a. AEMC® Instruments**

15 Faraday Drive

Dover, NH 03820 USA

Phone: (800) 945-2362 (Ext. 360)

(603) 749-6434 (Ext. 360)

Fax: (603) 742-2346 or (603) 749-6309

E-mail: repair@aemc.com

Caution: To protect yourself against in-transit loss, we recommend you insure your returned material.

NOTE: You must obtain a CSA# before returning any instrument.

NOTES:



01/13

99-MAN 100374 v6