

Agilent InfiniiVision 5000 Series Oscilloscopes

User's Guide



Agilent Technologies

Notices

© Agilent Technologies, Inc. 2005-2008

No part of this manual may be reproduced in any form or by any means (including electronic storage and retrieval or translation into a foreign language) without prior agreement and written consent from Agilent Technologies, Inc. as governed by United States and international copyright laws.

Manual Part Number

54574-97026

Edition

Third Edition, January 2008

Printed in Malaysia

Agilent Technologies, Inc.
395 Page Mill Road
Palo Alto, CA 94303 USA

A newer version of this manual may be available at

www.agilent.com/find/dso5000

Software Revision

This guide was written for version 5.00 of the Agilent InfiniiVision 5000 Series Oscilloscope software.

Trademark Acknowledgments

Java is a U.S. trademark of Sun Microsystems, Inc.

Sun, Sun Microsystems, and the Sun Logo are trademarks or registered trademarks of Sun Microsystems, Inc. in the U.S. and other countries.

Windows and MS Windows are U.S. registered trademarks of Microsoft Corporation.

Warranty

The material contained in this document is provided “as is,” and is subject to being changed, without notice, in future editions. Further, to the maximum extent permitted by applicable law, Agilent disclaims all warranties, either express or implied, with regard to this manual and any information contained herein, including but not limited to the implied warranties of merchantability and fitness for a particular purpose. Agilent shall not be liable for errors or for incidental or consequential damages in connection with the furnishing, use, or performance of this document or of any information contained herein. Should Agilent and the user have a separate written agreement with warranty terms covering the material in this document that conflict with these terms, the warranty terms in the separate agreement shall control.

Technology Licenses

The hardware and/or software described in this document are furnished under a license and may be used or copied only in accordance with the terms of such license.

Restricted Rights Legend

If software is for use in the performance of a U.S. Government prime contract or subcontract, Software is delivered and licensed as “Commercial computer software” as defined in DFAR 252.227-7014 (June 1995), or as a “commercial item” as defined in FAR 2.101(a) or as “Restricted computer software” as defined in FAR 52.227-19 (June 1987) or any equivalent agency regulation or contract clause. Use, duplication or disclosure of Software is subject to Agilent Technologies’ standard commercial license terms, and non-DOD Departments and Agencies of the U.S. Government will

receive no greater than Restricted Rights as defined in FAR 52.227-19(c)(1-2) (June 1987). U.S. Government users will receive no greater than Limited Rights as defined in FAR 52.227-14 (June 1987) or DFAR 252.227-7015 (b)(2) (November 1995), as applicable in any technical data.

Safety Notices

CAUTION

A **CAUTION** notice denotes a hazard. It calls attention to an operating procedure, practice, or the like that, if not correctly performed or adhered to, could result in damage to the product or loss of important data. Do not proceed beyond a **CAUTION** notice until the indicated conditions are fully understood and met.

WARNING

A **WARNING** notice denotes a hazard. It calls attention to an operating procedure, practice, or the like that, if not correctly performed or adhered to, could result in personal injury or death. Do not proceed beyond a **WARNING** notice until the indicated conditions are fully understood and met.

In This User's Guide...

This guide shows you how to use the InfiniiVision 5000 Series oscilloscopes. It contains the following chapters and topics:

- 1 Getting Started**
Unpacking and setting up your oscilloscope, using Quick Help.
- 2 Front-Panel Controls**
A quick overview of the front-panel controls.
- 3 Triggering the Oscilloscope**
Trigger modes, coupling, noise rejection, holdoff, external trigger and more. Edge, pulse width, pattern, duration, and TV/video triggering.
- 4 Making Measurements**
XY mode, FFTs, math functions, using cursors, automatic measurements.
- 5 Displaying Data**
Using pan and zoom; normal, average, peak detect, and high resolution (smoothing) modes; noise rejection modes, glitch capture, and more.
- 6 Saving and Printing Data**
Printing waveforms, saving setups and data, and using the file explorer.
- 7 Reference**
Software updates, I/O, Warranty status, and more.
- 8 Power and Environmental Conditions**
Specifications and characteristics of the oscilloscope.

The Agilent InfiniiVision 5000 Series oscilloscopes deliver powerful features and high performance:

- 100 MHz, 300 MHz, and 500 MHz bandwidth models.
- 2-channel and 4-channel Digital Storage Oscilloscope (DSO) models.
- Up to 4 GSa/s sample rate.
- Powerful triggering.
- USB, LAN, and GPIB ports make printing, saving and sharing data easy.
- Color XGA display.
- Secure environment mode option.

The InfiniiVision 5000 Series oscilloscopes feature MegaZoom III technology:

- Most responsive deep memory.
- Highest definition color display.
- Fastest waveform update rates, uncompromised.

Table 1 5000 Series Oscilloscopes Model Numbers and Sampling Rates

Bandwidth	100 MHz	300 MHz	500 MHz
Maximum Sample Rate	2 GSa/s	2 GSa/s	4 GSa/s
2-Channel DSO	DSO5012A	DSO5032A	DSO5052A
4-Channel DSO	DSO5014A	DSO5034A	DSO5054A

Built-in Quick Help

A Quick Help system is built into the oscilloscope. Instructions for using the quick help system are given on [page 41](#).

Abbreviated instructions for pressing a series of keys

Instructions for pressing a series of keys are written in an abbreviated manner. Instructions for pressing Key1, then pressing Key2, then pressing Key3 are abbreviated as follows:



Press **Key1** → **Key2** → **Key3**.

The keys may be front panel keys, or softkeys, which are located directly below the oscilloscope display.

Direct your Web browser to www.agilent.com/find/dso5000 to

- Get software updates
- Download a newer version of this manual (if available)
- View or print the oscilloscope's data sheet
- Find out more about InfiniiVision 5000 Series oscilloscopes



Contents

1	Getting Started	15
	To inspect package contents	16
	To adjust the handle	20
	To tilt the oscilloscope for easy viewing	21
	To mount the oscilloscope in a rack	21
	To power-on the oscilloscope	22
	Ventilation requirements	22
	The remote interface	24
	To establish a LAN connection	25
	To establish a point-to-point LAN connection	27
	To use the Web interface	28
	Controlling the oscilloscope using a Web browser	29
	Setting a password	32
	Printing the oscilloscope's display from a web browser	34
	To connect the oscilloscope probes	35
	 Maximum input voltage in 50 Ω mode	35
	 Maximum input voltage for analog inputs	36
	To verify basic oscilloscope operation	37
	To compensate the oscilloscope probes	38
	To calibrate the probes	39
	Passive Probes Supported	39
	Active Probes Supported	40

Contents

Using Quick Help	41
Quick Help Languages	42
Quick Help Updates	42
2 Front-Panel Controls	43
Front-Panel Controls	44
Conventions	45
Graphic Symbols in Softkey Menus	45
4-Channel InfiniiVision 5000 Series Oscilloscope Front Panel	46
Front Panel Controls	47
2-Channel InfiniiVision 5000 Series Oscilloscope Front Panel (differences only)	51
Interpreting the display	52

Front-Panel Operation	53
To adjust the waveform intensity	53
To adjust the display grid (graticule) intensity	53
To start and stop an acquisition	53
To make a single acquisition	55
To pan and zoom	56
Choosing Auto trigger mode or Normal trigger mode	56
Using AutoScale	57
Example exercise	57
To set the probe attenuation factor	58
Using the channels	60
To set up the Horizontal time base	65
To make cursor measurements	72
To make automatic measurements	73
Using Labels	74
To print the display	78
To set the clock	78
To set up the screen saver	80
To set the waveform expansion reference point	81
To perform service functions	82
User Calibration	82
Self Test	86
About Oscilloscope	87
To restore the oscilloscope to its default configuration	88
3 Triggering the Oscilloscope	89
Selecting Trigger Modes and Conditions	91
To select the Mode and Coupling menu	91
Trigger modes: Normal and Auto	92
To select trigger Coupling	94
To select trigger Noise Rejection and HF rejection	94
To set Holdoff	95

The External Trigger input	97
2-Channel oscilloscope External Trigger input	97
 Maximum input voltage for external trigger (2-channel oscilloscopes)	98
4-Channel oscilloscope External Trigger input	99
 Maximum input voltage for external trigger (4-channel oscilloscopes)	99
Trigger Types	100
To use Edge triggering	101
Trigger level adjustment	102
To use Pulse Width triggering	103
< qualifier time set softkey	105
> qualifier time set softkey	105
To use Pattern triggering	106
To use CAN triggering	108
To use I2C triggering	112
To use LIN triggering	118
To use SPI triggering	121
Assign source channels to the clock, data, and frame signals	123
Set up the number of bits in the serial data string and set values for those data bits	126
Resetting all bits in the serial data string to one value	126
To use Duration triggering	127
< qualifier time set softkey	128
> qualifier time set softkey	129

To use TV triggering	130
Example exercises	134
To trigger on a specific line of video	134
To trigger on all sync pulses	136
To trigger on a specific field of the video signal	137
To trigger on all fields of the video signal	138
To trigger on odd or even fields	139
To use UART/RS232 triggering	142
The Trigger Out connector	147

4 Making Measurements 149

To use the XY horizontal mode	150
Math Functions	155
Math scale and offset	156
Multiply	157
Subtract	159
Differentiate	161
Integrate	163
FFT Measurement	165
FFT Operation	167
Square Root	172
Cursor Measurements	174
To make cursor measurements	174
Cursor Examples	178
Automatic Measurements	181
To make an automatic measurement	183
To set measurement thresholds	184
Time Measurements	186
Delay and Phase Measurements	190
Voltage Measurements	193
Overshoot and Preshoot Measurements	198

5	Displaying Data	201
	Pan and Zoom	202
	To pan and zoom a waveform	202
	To set the waveform expansion reference point	203
	Antialiasing	204
	Using the XGA video output	204
	Display Settings	205
	Infinite persistence	205
	Grid intensity	206
	Vectors (connect the dots)	206
	Varying the intensity to view signal detail	208
	Acquisition Modes	209
	At Slower Sweep Speeds	209
	Selecting the Acquisition mode	209
	Normal Mode	210
	Peak Detect Mode	210
	High Resolution Mode	210
	Averaging Mode	211
	Realtime Sampling Option	214
	Using Serial Decode	216
	To decode I ² C data	217
	To decode SPI data	221
	To decode CAN data	226
	CAN Totalizer	231
	To decode LIN data	233
	To decode UART/RS232 data	239
	UART/RS232 Totalizer	245

To reduce the random noise on a signal	246
HF Reject	246
LF Reject	247
Noise rejection	247
To capture glitches or narrow pulses with peak detect and infinite persistence	248
Using peak detect mode to find a glitch	250
How AutoScale Works	251
Undo AutoScale	251
Specifying the Channels Displayed After AutoScale	252
Preserving the Acquisition Mode During AutoScale	252
6 Saving and Printing Data	253
Printing the oscilloscope's display	254
Print options	254
Selecting print options	255
Palette	255
Supported Printers	256
Saving oscilloscope data	258
Selecting a destination for your saved data	259
Selecting a file name	260
Waveform Trace and Oscilloscope Setup	262
Display Image and Waveform Data Files	262
Choosing save settings	263
To save a waveform and/or setup to a USB device	265
To save a waveform and/or setup to the oscilloscope's internal memory	265
To recall waveform trace and/or oscilloscope setup	266
File explorer	266
To use the file explorer	268
Secure Environment Mode Option	269

7	Reference	271
	Software and firmware updates	272
	To set up the I/O port	273
	To check warranty and extended services status	273
	To return the instrument	274
	To clean the oscilloscope	274
	Binary Data (.bin)	275
	Binary Data in MATLAB	275
	Binary Header Format	275
	Example Program for Reading Binary Data	279
	Examples of Binary Files	280
	Minimum and Maximum Values in CSV Files	281
8	Power and Environmental Conditions	283
	Power Requirements	284
	Measurement Category	285
	Measurement Category Definitions	285
	Transient Withstand Capability	286
	 Maximum input voltage for analog inputs	286
	Environmental Conditions	287
	Specifications	288
	Acknowledgements	288
	Contact us	289
8		289
	Index	291



1 Getting Started

To inspect package contents	16
To adjust the handle	20
To mount the oscilloscope in a rack	21
To power-on the oscilloscope	22
Ventilation requirements	22
The remote interface	24
To establish a LAN connection	25
To establish a point-to-point LAN connection	27
To use the Web interface	28
Setting a password	32
To connect the oscilloscope probes	35
Printing the oscilloscope's display from a web browser	34
To verify basic oscilloscope operation	37
To compensate the oscilloscope probes	38
To calibrate the probes	39
Passive Probes Supported	39
Active Probes Supported	40
Using Quick Help	41



To get started using the oscilloscope:

- ✓ Unpack the oscilloscope and verify the contents.
- ✓ Adjust the oscilloscope's handle position.
- ✓ Tilt the oscilloscope for easy viewing if desired.
- ✓ Apply power to the oscilloscope.
- ✓ Connect the probes to the oscilloscope.
- ✓ Verify basic oscilloscope operation and compensate the probes.

To inspect package contents

- ✓ Inspect the shipping container for damage.

If your shipping container appears to be damaged, keep the shipping container or cushioning material until you have inspected the contents of the shipment for completeness and have checked the oscilloscope mechanically and electrically.

- ✓ Verify that you received the following items and any optional accessories you may have ordered:
 - InfiniiVision 5000 Series Oscilloscope
 - Front-panel cover
 - Power cord (see [Table 3](#) on page 23)
 - Oscilloscope probes
 - Two probes for 2-channel models
 - Four probes for 4-channel models
 - N2863A probes for 100 MHz and 300 MHz bandwidth models
 - 10073C probes for 500 MHz bandwidth models
 - User's Guide
 - CD-ROM containing the Programmer's Quick Start Guide, Programmer's Reference Guide, and Service Guide
 - Automation-Ready Software CD-ROM

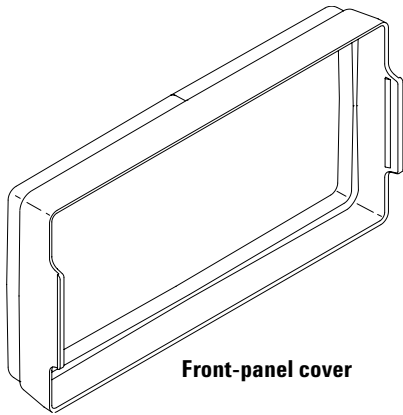

Front-panel cover

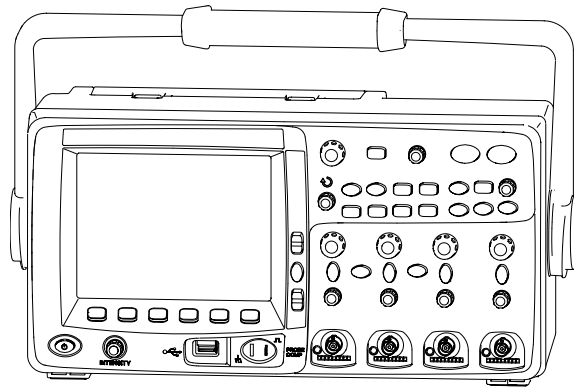

**InfiniiVision 5000 Series
Oscilloscope**

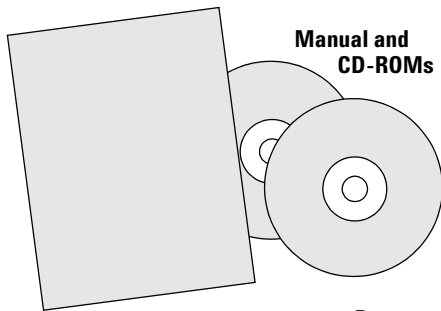

Manual and
CD-ROMs

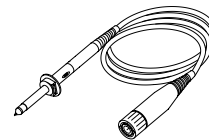

Oscilloscope probes
N2863A or 10073C
(Qty 2 or 4)

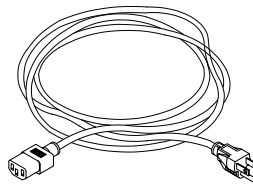

Power cord
(Part numbers given
on [page 23](#))

Package contents for InfiniiVision 5000 Series oscilloscopes

Table 2 Accessories available

Model	Description
N2760A	Soft carrying case
N2917B	Transit case
N2916B	Rackmount Kit
54684-44101	Front-panel cover
N2605A-097	USB cable
10833A	GPIB cable, 1 m long
5061-0701	LAN crossover cable
10070C	Passive probe, 1:1 20 MHz, 1.5 m
10074C	Passive probe, 10:1, 150 MHz, 1.5 m
10073C	Passive probe, 10:1, 500 MHz, 1.5 m
1165A	Passive probe, 10:1, 600 MHz, 1.5 m
10076A	Passive probe, 100:1, 4 kV, 250 MHz
N2771A	Passive probe, 1000:1, 30 kV, 50 MHz
1156A	Active probe, 1.5 GHz AutoProbe interface
1144A	Active probe, 800 MHz (requires 1142A – power supply)
1145A [†]	Active probe, 750 MHz 2-ch (requires 1142A – power supply)
1130A [†]	For active differential probes: 1.5 GHz InfiniiMax amplifier with AutoProbe interface (requires one or more InfiniiMax probe head – E2675A, E2668A, E2669A).
N2772A	Active differential probe, 20 MHz, 1.2 kVDC + peak AC max (requires N2773A power supply)
1141A	Active differential probe, 200 MHz, 200 VDC + peak AC max (requires 1142A power supply)
1146A	Current probe, 100 kHz, 100 A, AC/DC
1147A [†]	Current probe, 50 MHz, 30 A, AC/DC with AutoProbe interface
N2780A	Current probe, 2 MHz, 500 A, AC/DC (use with N2779A power supply)
N2781A	Current probe, 10 MHz, 150 A, AC/DC (use with N2779A power supply)
N2782A	Current probe, 50 MHz, 30 A, AC/DC (use with N2779A power supply)
N2783A	Current probe, 100 MHz, 30 A, AC/DC (use with N2779A power supply)
10072A	Fine-pitch probe kit
10075A	0.5 mm IC clip kit
10076A	100:1, 4 kV 250 MHz probe
E2613B	0.5 mm Wedge probe adapter, 3-signal, qty 2

Model	Description
E2614A	0.5 mm Wedge probe adapter, 8-signal, qty 1
E2615B	0.65 mm Wedge probe adapter, 3-signal, qty 2
E2616A	0.65 mm Wedge probe adapter, 8-signal, qty 1
E2643A	0.5 mm Wedge probe adapter, 16-signal, qty 1
E2644A	0.65 mm Wedge probe adapter, 16-signal, qty 1

†Indicates a maximum of two of this model probe can be connected to each oscilloscope due to AutoProbe interface current supply limitation. See also “Passive Probes Supported” on page 39 and “Active Probes Supported” on page 40.

You can find these items at www.agilent.com or at www.parts.agilent.com.

For information on more probes and accessories see “5989-6162EN Probes and Accessories Selection Guide” and “5968-8153EN 5000 and 6000 Series Oscilloscope Probes and Accessories data sheet, available at www.agilent.com.

To adjust the handle

The oscilloscope's handle can be locked in one of three positions:

- up, for carrying
- back, so the handle is out of the way
- down, so the oscilloscope can be tilted back for easy viewing when the oscilloscope is on the floor and you are standing above it.

- 1 To rotate the handle, grasp the handle hubs on each side of the instrument and pull the hubs out until they stop.

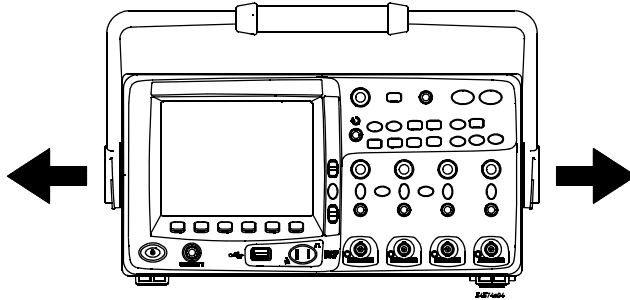

- 2 Without releasing the hubs, rotate the handle to the desired position. Then release the hubs. Continue rotating the handle until it clicks into a set position.

To tilt the oscilloscope for easy viewing

The tilt tabs (underneath the oscilloscope) can be positioned as shown in the center picture below. The handle can be used as a stand when placing the oscilloscope on a floor, as shown in the picture on the right.

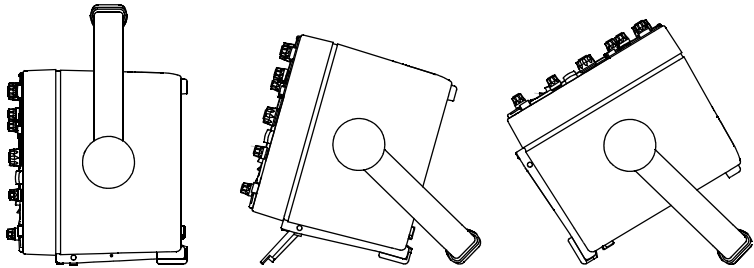

To mount the oscilloscope in a rack

The InfiniiVision 5000 Series oscilloscopes can be mounted into Electronic Industries Association (EIA) standard 19-inch (487-mm) rack cabinets.

To mount the oscilloscope in a rack, purchase and install the N2916B rack mount kit. Instructions are included in the kit.

To power-on the oscilloscope

- 1 Connect the power cord to the rear of the oscilloscope, then to a suitable AC voltage source.

The oscilloscope automatically adjusts for input line voltages in the range 100 to 240 VAC. Ensure that you have the correct line cord. See [Table 3](#) on page 23. The line cord provided is matched to the country of origin.

WARNING

Always use a grounded power cord. Do not defeat the power cord ground.

- 2 Press the power switch.

The power switch is located on the lower left corner of the front panel. The front panel lights will come on and the oscilloscope will be operational in a few seconds.

Ventilation requirements













The air intake and exhaust areas must be free from obstructions. Unrestricted air flow is required for proper cooling.

Ventilation Requirements

The fan draws air in from underneath the oscilloscope and pushes it out behind the oscilloscope. Always ensure that the air intake and exhaust areas are free from obstructions.

When using the oscilloscope in a bench-top setting, provide at least 4" (100 mm) clearance behind and above the oscilloscope for proper cooling.

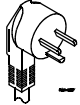
Table 3 Power Cords

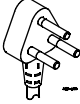
Plug Type	Cable Part Number	Plug Type	Cable Part Number
Opt 900 (U.K.) 	8121-1579	Opt 918 (Japan) 	8121-1603
Opt 901 (Australia) 	8121-1581	Opt 919 (Israel) 	8121-1662
Opt 902 (Europe) 	8121-1580	Opt 920 (Argentina) 	8121-1599
Opt 903 (U.S.A.) 	8121-1609	Opt 921 (Chile) 	8121-1600
Opt 906 (Switzerland) 	8121-1602	Opt 922 (China) 	8121-1606
Opt 912 (Denmark) 	8121-1601	Opt 927 (Thailand) 	8120-0674
Opt 917 (India) 	8121-1604	Opt 923 (South Africa) Opt 930 (Brazil) Opt 931 (Taiwan) Opt 932 (Cambodia)	8121-1641 8121-1613 8121-1637 8121-1633

The remote interface

You can communicate with all InfiniiVision 5000 Series oscilloscopes using the front panel keys, or via LAN, USB, or GPIB.

The *Automation Ready CD-ROM* provided with the oscilloscope contains connectivity software to enable communication over these interfaces. Refer to the instructions provided on the CD-ROM to install this software on your PC.

Remote commands can be issued via LAN, USB, or GPIB. These commands are generally used when the oscilloscope is under program control for automated test and data acquisition. Information about controlling the oscilloscope through remote commands is contained in the *Programmer's Quick Start Guide*, which is included in the documentation CD-ROM supplied with this oscilloscope. You can also access this document online. Direct your web browser to www.agilent.com/find/dso5000 and select Technical Support, then select Manuals.

All InfiniiVision 5000 Series oscilloscopes feature a built-in Web server (requires software version 4.0 or greater; see [page 272](#) for software updating instructions). Using the Web browser you can set up measurements, monitor waveforms, capture screen images and operate the oscilloscope remotely.

Detailed Connectivity Information

For detailed connectivity information, refer to the *Agilent Technologies USB/LAN/GPIB Interfaces Connectivity Guide*. For a printable electronic copy of the Connectivity Guide, direct your Web browser to www.agilent.com and search for Connectivity Guide.

To establish a LAN connection

- 1 If the controller PC isn't already connected to the local area network (LAN), do that first.
- 2 Get the oscilloscope's network parameters (hostname, domain, IP address, subnet mask, gateway IP, DNS IP, etc.) from your network administrator.
- 3 Connect the oscilloscope to the local area network (LAN) by inserting the LAN cable into the "LAN" port on the rear panel of the oscilloscope.
- 4 On the oscilloscope, ensure the controller interface is enabled:
 - a Press the **Utility** key.
 - b Using the softkeys, press **I/O** and **Control**.
 - c Use the Entry knob to select "LAN"; then, press the **Control** softkey again.
- 5 Configure the oscilloscope's LAN interface:
 - a Press the **Configure** softkey until "**LAN**" is selected.
 - b Press the **LAN Settings** softkey.
 - c Use the **Config** softkey and the Entry knob to select DHCP, AutoIP, or NetBIOS and associated options.
 - d Press the **Addresses** softkey. Use the **Modify** softkey (and the other softkeys and the Entry knob) to enter the IP Address, Subnet Mask, Gateway IP, and DNS IP values. When you are done, press the return (up arrow) softkey.
 - e Press the **Domain** softkey. Use the **Modify** softkey (and the other softkeys and the Entry knob) to enter the Host name and the Domain name. When you are done, press the return (up arrow) softkey.
 - f Press the **Apply** softkey to apply the changes.

NOTE

When you connect the oscilloscope to a LAN it is a good practice to limit access to the oscilloscope by setting a password. By default, the oscilloscope is not password protected. See [page 32](#) to set a password.

For more information about connecting to the oscilloscope, refer to the *Agilent Technologies USB/LAN/GPIB Interfaces Connectivity Guide*. For a printable electronic copy of the Connectivity Guide, direct your Web browser to www.agilent.com and search for Connectivity Guide.

To establish a point-to-point LAN connection

The following procedure describes how to establish a point-to-point (stand alone) connection to the oscilloscope. This is useful if you want to control the oscilloscope using a laptop computer or a stand-alone computer.

- 1 Install Agilent I/O Libraries Suite from the CD that was supplied with the oscilloscope. If you do not have the CD you can download the I/O Libraries Suite from www.agilent.com/find/iolib.
- 2 Connect your PC to the oscilloscope using a cross-over LAN cable, such as Agilent part number 5061-0701 (order separately).
- 3 Switch on the oscilloscope power.
- 4 Press **Utility** → **I/O**. The I/O status will be displayed. Wait for the **LAN Status** to indicate that the oscilloscope is “**configured**”. This may take a few minutes.
- 5 Start the Agilent Connection Expert application from the Agilent I/O Libraries Suite program group.
- 6 When the Agilent Connection Expert application is displayed, select **Refresh All**.
- 7 Right Click **LAN** and select **Add Instrument**.
- 8 In the Add Instrument window, the LAN line should be highlighted; select **OK**.
- 9 In the LAN Instrument window, select **Find Instruments...**
- 10 In the Search for instruments on the LAN window, **LAN** and **Look up hostnames** should be checked.
- 11 Select the **Find Now** key. (NOTE: It may take up to three minutes before the instrument is found. If the instrument is not found the first time, wait about one minute and try again.)
- 12 When the instrument is found, select **OK** and **OK** to close the Add Instrument windows.

Now the instrument is connected and the instrument’s Web interface may be used.

To use the Web interface

All InfiniiVision 5000 Series oscilloscopes include a built-in Web server.

When you connect to the oscilloscope using a computer and web browser, you can:

- Control the oscilloscope using the Remote Front Panel function.
- Activate the Identify function (see [page 31](#)) to identify a particular instrument by causing its front panel light to blink.
- View information about the oscilloscope like its model number, serial number, host name, IP address, and VISA address.
- View oscilloscope firmware version information and upload new firmware into the oscilloscope.
- View and modify the oscilloscope's network configuration and status information.

Agilent Technologies Oscilloscope Another web-enabled instrument from Agilent Technologies

Welcome to your **Web-Enabled Oscilloscope** **LXI**

Information about this Web-Enabled Instrument

Instrument	DSO5014A Oscilloscope
Serial Number	US46000022
Description	
Hostname	cos-rd-dhcp16.cos.agilent.com
IP Address	130.29.71.172
VISA TCP/IP Connect String	TCPIP0::cos-rd-dhcp16::INSTR

Advanced information Identification: off on

Use the navigation bar on the left to access your Oscilloscope and related information.

© Agilent Technologies, Inc. 2006

Controlling the oscilloscope using a Web browser

A built-in Web server allows communication and control via a Java™-enabled Web browser. Measurements can be set up, waveforms can be monitored, screen images can be captured, and the oscilloscope can be operated remotely. Also, SCPI (Standard Commands for Programmable Instrumentation) commands can be sent over the LAN.

The recommended Web browser for communication and control of the oscilloscope is Microsoft Internet Explorer 6 or higher. Other Web browsers may work but are not guaranteed to work with the oscilloscope. The Web browser must be Java-enabled with the Sun Microsystems™ Java Plug-in.

To operate the oscilloscope using a Web browser

- 1 Connect the oscilloscope to your LAN (see [page 25](#)), or establish a point-to-point connection (see [page 27](#)). It is possible to use a point-to-point connection (see [page 27](#)), but using a LAN is the preferred method.
- 2 Type the oscilloscope's host name or IP address into your Web browser to navigate to the oscilloscope's Welcome page.
- 3 When the oscilloscope's Web page is displayed, select **Browser Web Control**, then select **Remote Front Panel**. After a few seconds the Remote Front Panel appears.

NOTE

If Java is not installed on your PC, you will be prompted to install the Sun Microsystems Java Plug-in. This plug-in must be installed on the controlling PC for Remote Front Panel operation.

- 4 Use the Menu Bar and the Tool Bar to control the oscilloscope. This is a manual way to control an oscilloscope which is normally controlled by a remote program.

1 Getting Started

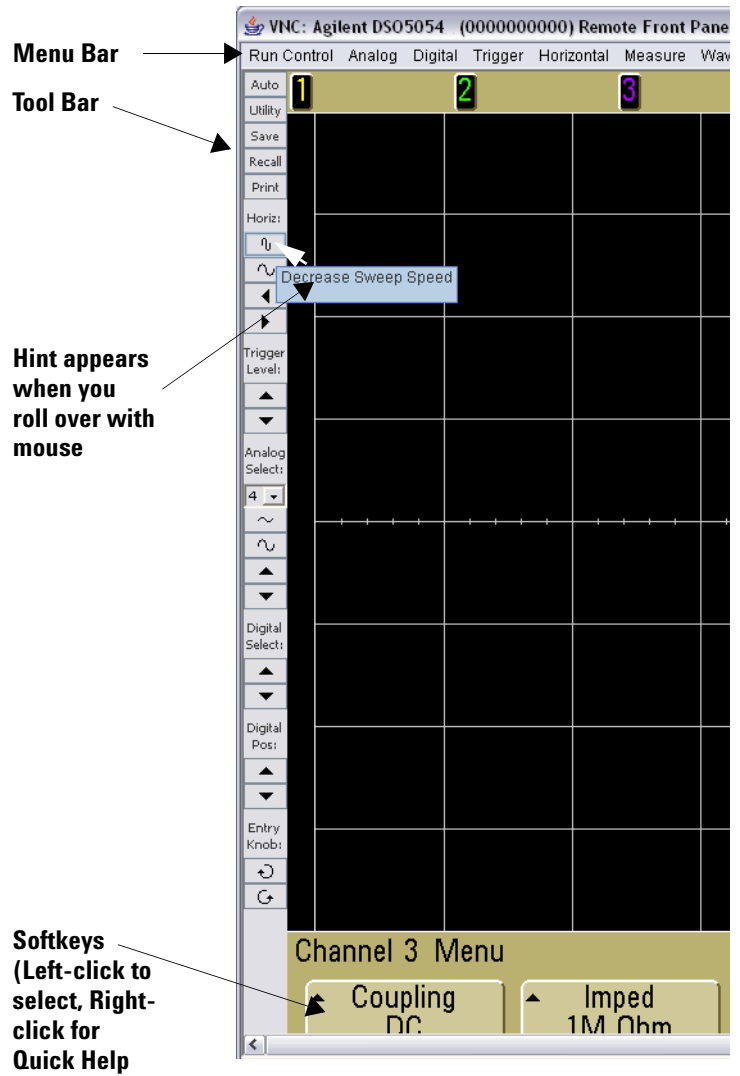

Scrolling and Monitor Resolution

When using a monitor resolution of 1024 x 768 or less on the remote computer, you need to scroll to access the full remote front panel. To display the remote front panel without scroll bars, use a monitor resolution greater than 1024 x 768 on your computer's display.

Identify Function

Select the Identify **On** button (located below the picture of the oscilloscope) on the oscilloscope's Welcome page. An “**Identify**” message will be displayed and you will need to press the **OK** softkey or switch Identify off on the web page to continue. This feature is useful when trying to locate a specific instrument in a rack of equipment.

Agilent Technologies Oscilloscope

Another from Agi

Welcome Page

Browser Web Control

Get Image

Instrument Utilities

Configure Network

Network Status

Print Page

Help with this Page

Welcome to your
Web-Enabled Oscilloscope

Information about this Web-Enabled Instrument

Instrument	DSO5054 Oscilloscope
Serial Number	0000000000
Description	Agilent DSO5054 (0000000000)
Hostname	reedpk.cos.agilent.com
IP Address	130.29.71.111
VISA TCP/IP Connect String	TCPIP0::reedpk::INSTR

Advanced information

Use the navigation bar on the left to access your Oscilloscope and related information.

© Agilent Technologies, Inc. 2006

Identification: off on

Identify Button

Setting a password

Whenever you connect the oscilloscope to a LAN, it is a good practice to set a password to prevent unauthorized access to the oscilloscope via Web browser.

- 1 Select the Configure Network tab from the instrument's Welcome page.
- 2 Select the Modify Configuration button.

The screenshot shows the Agilent Technologies Oscilloscope web interface. On the left is a navigation menu with the following items: Welcome Page, Browser Web Control, Get Image, Instrument Utilities, **Configure Network** (highlighted with an arrow labeled 'Step 1'), Network Status, Print Page, and Help with this Page. The main content area is titled 'Current Network Configuration' and features a 'Modify Configuration' button (highlighted with an arrow labeled 'Step 2'). Below the button is a table of network parameters.

Parameter	Currently in use
Configuration mode	DHCP
Dynamic DNS	ON
NetBIOS	OFF
IP Address	130.29.69.81
Subnet Mask	255.255.248.0
Default Gateway	130.29.64.1
DHCP Server	130.29.64.128
DNS Server	130.29.64.128, 130.29.108.128
Hostname	a-d5054a-091557
Domain	cos.agilent.com
LAN KeepAlive Timeout	1800
Media Sense	ON
GPIB Control	ON
GPIB Address	7

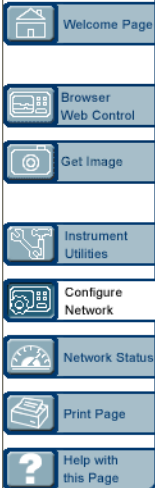

Modify Network Configuration

Parameter	Configured Value	Edit Configuration
IP Settings may be configured using the following:		
DHCP	ON	<input type="radio"/> OFF <input checked="" type="radio"/> ON
Automatic IP	ON	<input type="radio"/> OFF <input checked="" type="radio"/> ON
Manual	ON	<input type="radio"/> OFF <input checked="" type="radio"/> ON
IP Settings to use in manual mode:		
IP Address	169.254.9.80	<input type="text" value="169.254.9.80"/>
Subnet Mask	255.255.0.0	<input type="text" value="255.255.0.0"/>
Default Gateway	0.0.0.0	<input type="text" value="0.0.0.0"/>
Domain name and name service settings:		
DNS Server	0.0.0.0	<input type="text" value="0.0.0.0"/>
Hostname	a-d5054a-091557	<input type="text" value="a-d5054a-091557"/>
Domain		<input type="text"/>
Dynamic DNS	ON	<input type="radio"/> OFF <input checked="" type="radio"/> ON
NetBIOS	OFF	<input checked="" type="radio"/> OFF <input type="radio"/> ON
Other settings:		
KeepAlive Timeout (sec)	1800	<input type="text" value="1800"/>
Description		<input type="text"/>
Password		<input type="text"/>
GPIB Control	ON	<input type="radio"/> OFF <input checked="" type="radio"/> ON
GPIB Address	7	<input type="text" value="7"/>
USB Control	ON	<input type="radio"/> OFF <input checked="" type="radio"/> ON
LAN Control	ON	<input type="radio"/> OFF <input checked="" type="radio"/> ON

Step 3

- 3 Enter your desired password.
- 4 Select the “Apply Changes” button.

To reset the password:

- 1 Press **Utility** → **I/O** → **LAN Reset**.

Printing the oscilloscope’s display from a web browser

To print the oscilloscope’s display from a web browser:

- 1 Establish a connection to the oscilloscope as described in this chapter and go to the oscilloscope’s Welcome page.
- 2 Select the **Get Image** tab from the left side of the Welcome screen. After a delay of several seconds, the oscilloscope’s screen image will be displayed.
- 3 Right-click on the image and select “**Save Picture As...**”.
- 4 Select a storage location for the image file and click **Save**.

For more information about connecting the oscilloscope to a LAN see the *Agilent Technologies USB/LAN/GPIB Interfaces Connectivity Guide*. For a printable electronic copy of the Connectivity Guide, direct your Web browser to www.agilent.com and search for Connectivity Guide.

To connect the oscilloscope probes

Input impedance is selectable: 1 M Ω or 50 Ω . Press the channel on/off key (see [page 46](#)), then press the **Imped** softkey to select the input impedance.

The 1 M Ω mode is for use with many passive probes and for general purpose measurements. The high impedance minimizes the loading effect of the oscilloscope on the circuit under test.

The 50 Ω mode matches 50 Ω cables and some active probes commonly used in making high frequency measurements. This impedance matching gives you the most accurate measurements since reflections are minimized along the signal path.

- 1 Connect the supplied oscilloscope probe to an oscilloscope channel BNC connector on the front panel of the oscilloscope.
- 2 Connect the retractable hook tip on the probe tip to the circuit point of interest. Be sure to connect the probe ground lead to a ground point on the circuit.

CAUTION



Maximum input voltage in 50 Ω mode

Do not exceed 5 Vrms at the BNC in 50 Ω mode on the Agilent 5000 Series oscilloscopes. Input protection is enabled in 50 Ω mode and the 50 Ω load will disconnect if greater than 5 Vrms is detected. However the inputs could still be damaged, depending on the time constant of the signal. The 50 Ω input protection mode on the Agilent 5000 Series oscilloscopes only functions when the oscilloscope is powered on.

CAUTION



The probe ground lead is connected to the oscilloscope chassis and the ground wire in the power cord. If you need to measure between two live points, use a differential probe. Defeating the ground connection and “floating” the oscilloscope chassis will probably result in inaccurate measurements.

WARNING

Do not negate the protective action of the ground connection to the oscilloscope. The oscilloscope must remain grounded through its power cord. Defeating the ground creates an electric shock hazard.

CAUTION



Maximum input voltage for analog inputs

CAT I 300 Vrms, 400 Vpk; transient overvoltage 1.6 kVpk

CAT II 100 Vrms, 400 Vpk

with N2863A 10:1 probe: CAT I 600 V, CAT II 300 V (DC + peak AC)

with 10073C 10:1 probe: CAT I 500 Vpk, CAT II 400 Vpk

To verify basic oscilloscope operation

To verify that you can display a signal on the oscilloscope:

- 1 Press the **Save/Recall** key on the front panel, then press the **Default Setup** softkey. (The softkeys are located directly below the display on the front panel.) The oscilloscope is now configured to its default settings.
- 2 Connect an oscilloscope probe from channel 1 to the **Probe Comp** signal terminal on the front panel.
- 3 Connect the probe's ground lead to the ground terminal that is next to the **Probe Comp** terminal.
- 4 Press **AutoScale**.
- 5 You should see a waveform on the oscilloscope's display similar to this:



If you see the waveform, but the square wave is not shaped correctly as shown above, perform the procedure [“To compensate the oscilloscope probes”](#) on page 38.

If you do not see the waveform, ensure your power source is adequate, the oscilloscope is properly powered-on, and the probe is connected securely to the front-panel oscilloscope channel input BNC and to the Probe Comp terminal.

To compensate the oscilloscope probes

You should compensate your oscilloscope probes to match their characteristics to the oscilloscope's channels. A poorly compensated probe can introduce measurement errors.

To compensate the N2863A probes, follow the procedure that was supplied with the probes.

To compensate the 10073C probes, use the procedure that was supplied with the probes or the following procedure.

- 1 Perform the procedure [“To verify basic oscilloscope operation”](#) on page 37.
- 2 Use a nonmetallic tool to adjust the trimmer capacitor on the probe for the flattest pulse possible. The trimmer capacitor is located on the probe BNC connector.

Perfectly compensated

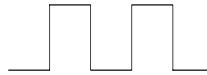

Over compensated



Under compensated



- 3 Connect probes to all other oscilloscope channels (channel 2 of a 2-channel oscilloscope, or channels 2, 3, and 4 of a 4-channel oscilloscope). Repeat the procedure for each channel. This matches each probe to each channel.

The process of compensating the probes serves as a basic test to verify that the oscilloscope is functional.

To calibrate the probes

The oscilloscope can accurately calibrate its oscilloscope channels to certain active probes, such as InfiniiMax probes. Other probes, such as the 10073C and N2863A passive probes, do not require calibration. The Calibrate Probe softkey will be grayed-out (ghosted; displayed in faint text) when a connected probe does not require calibration.

When you connect a probe that can be calibrated (such as an InfiniiMax probe), the **Calibrate Probe** softkey in the channel's menu will become active. Connect the probe to the Probe Comp terminal, and the probe ground to the Probe Comp ground terminal. Press the **Calibrate Probe** softkey and follow the instructions on the display.

NOTE

When calibrating a differential probe, connect the positive lead to the Probe Comp terminal and the negative lead to the Probe Comp ground terminal. You may need to connect an alligator clip to the ground lug to allow a differential probe to span between the Probe Comp test point and ground. A good ground connection ensures the most accurate probe calibration.

Passive Probes Supported

The following passive probes can be used with the 5000 Series oscilloscopes. Any combination of passive probes can be used.

Table 4 Passive Probes

Passive Probes	Quantity Supported
N2863A	4
10070C	4
10073C	4
10074C	4
10076A	4

Active Probes Supported

Active probes that do not have their own external power supply require substantial power from the AutoProbe interface. “Quantity Supported” indicates the maximum number of each type of active probe that can be connected to the oscilloscope. If too much current is drawn from the AutoProbe interface, an error message will be displayed, indicating that you must momentarily disconnect all probes to reset the AutoProbe interface.

Table 5 Active Probes

Active Probes	Quantity Supported
1130A	2
1131A	2
1132A	2
1134A	2
1141A with 1142A power supply	4
1144A with 1142A power supply	4
1145A with 1142A power supply	2
1147A	2
1156A	4
1157A	4
1158A	4
N2772A with N2773A power supply	4
N2774A with N2775A power supply	4

Using Quick Help

To view Quick Help

- 1 Press and hold down the key or softkey for which you would like to view help.

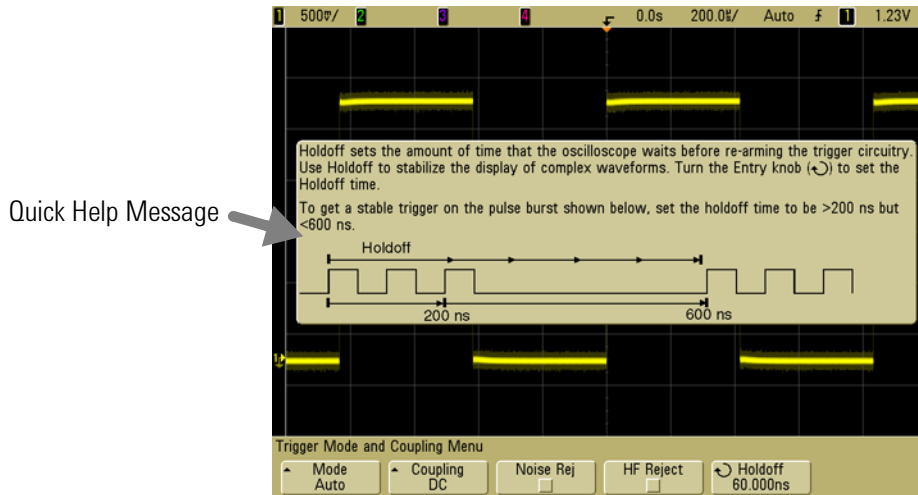

Press and Hold Front Panel Key or Softkey
or Right-Click Softkey when using Web browser control

You can set Quick Help to close when you release the key (this is the default mode) or to remain on the screen until another key is pressed or a knob is turned. To select this mode, press the **Utility** key, then press the **Language** softkey, then press the **Help Remain/Help Close** softkey.

When Quick Help is used from Web browser control, the Quick Help remains visible until you click on the screen, regardless of whether **Help Remain** or **Help Close** is selected.

Quick Help Languages

To choose a Quick Help language in the oscilloscope:

- 1 Press **Utility**, then press the **Language** softkey.
- 2 Repeatedly press and release the **Language** softkey or rotate the Entry knob until the desired language is selected.

Quick Help Updates

Updated Quick Help for the 5000 Series oscilloscopes may be made available. If so, it will be available at www.agilent.com/find/dso5000.

- 1 Direct your web browser to www.agilent.com/find/dso5000sw.
- 2 Select **Quick Help Language Support** and follow the directions.

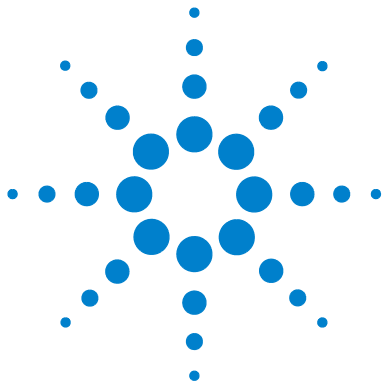

2 Front-Panel Controls

Front-Panel Controls 44
Front-Panel Operation 53



Front-Panel Controls

This is an introduction to the front-panel controls of the Agilent InfiniiVision 5000 Series oscilloscope. Generally, you set up the front-panel controls and then make a measurement.

The keys on the front panel bring up softkey menus on the display that provide access to oscilloscope features. Many softkeys use the Entry knob  to select values.

Six softkeys are located below the display. To understand the symbols used in the softkey menus and throughout this guide, see “[Conventions](#)” on page 45.

NOTE

The simplest way to set up the oscilloscope is to connect it to the signals of interest and press the **AutoScale** key.

Conventions



Throughout this book, the front-panel keys and softkeys are denoted by a change in font. For example, the **Cursors** key is in the Measure section of the front panel. The **Acq Mode** softkey is the left-most softkey when the Acquire menu is displayed.

Instructions for pressing a series of keys are written in an abbreviated manner. Pressing the **Utility** key, then the **I/O** softkey, then the **Configure LAN** softkey is abbreviated as follows:

Press **Utility** → **I/O** → **Configure LAN**.

Graphic Symbols in Softkey Menus

The following graphic symbols appear in the oscilloscope's softkey menus. The softkey menus appear at the bottom of the display, just above the six softkeys.

 Use the Entry knob to adjust the parameter. The Entry knob is located on the front panel. The  symbol above the knob is illuminated when this control is active.

 Press the softkey to display a pop up with a list of choices. Repeatedly press the softkey until your choice is selected.

 Use the Entry knob labeled  and/or press the softkey to adjust the parameter.

 Press the softkey to display a pop-up menu. Press the softkey or rotate and push the Entry knob to make an item active.

 Option is selected but not active.

 Option is selected and active.

 Feature is on. Press the softkey again to turn the feature off.

 Feature is off. Press the softkey again to turn the feature on.

 Press the softkey to view the menu.

 Press the softkey to return to the previous menu.

4-Channel InfiniiVision 5000 Series Oscilloscope Front Panel

The following diagram shows the front panel of the InfiniiVision 5000 Series 4-channel oscilloscopes. The controls of the 2-channel oscilloscopes are very similar. For a diagram showing the differences of the 2-channel oscilloscope, see [page 51](#).

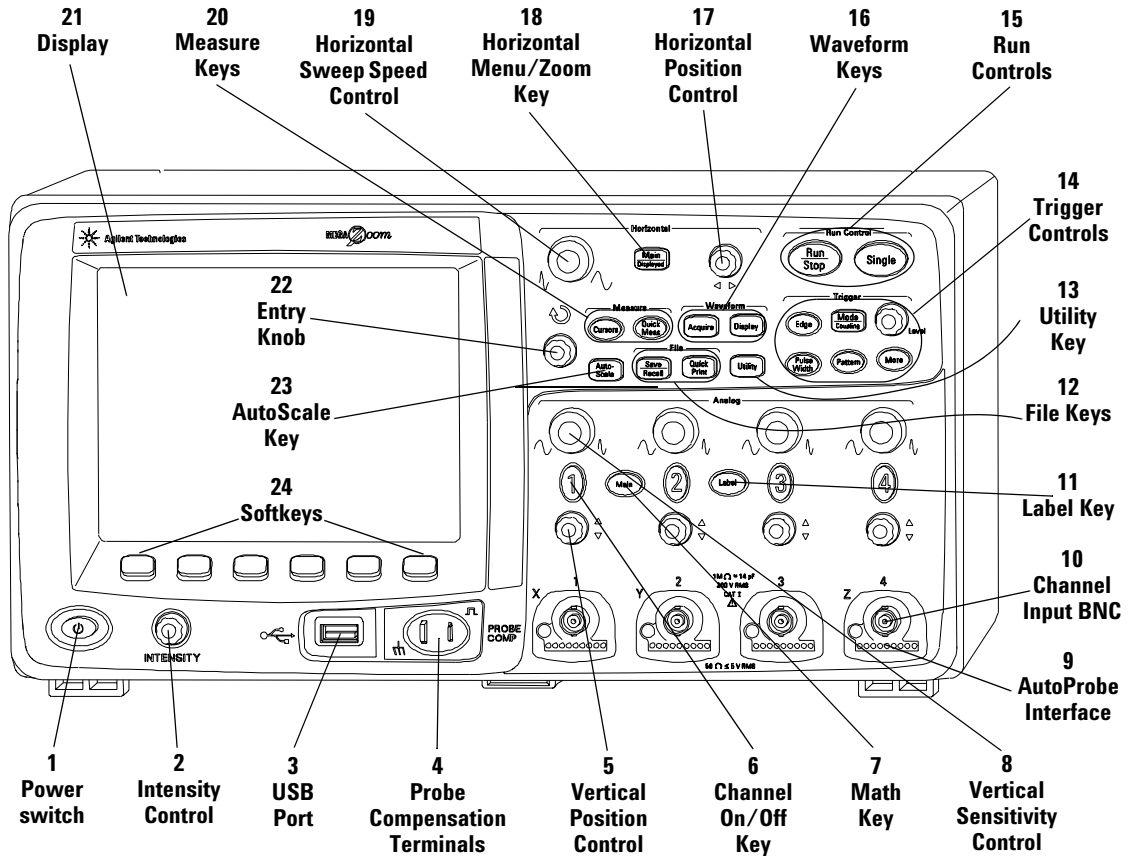

Figure 1 InfiniiVision 5000 Series 4-Channel Oscilloscope Front Panel

Front Panel Controls

1. Power Switch Press once to switch power on; press again to switch power off. See [page 22](#).

2. Intensity Control Rotate clockwise to increase waveform intensity; counterclockwise to decrease. You can vary the intensity control to bring out signal detail, much like an analog oscilloscope. More details about using the Intensity control to view signal detail are on [page 208](#).

3. USB Host Port Connect a USB compliant mass storage device to store or recall oscilloscope setup files or waveforms. You can also use the USB port to update the oscilloscope's system software or Quick Help language files if updates are available. You do not need to take special precautions before removing the USB mass storage device from the oscilloscope (you do not need to "eject" it). Simply unplug the USB mass storage device from the oscilloscope when the file operation is complete. More information on using the USB port is given in [Chapter 6](#), "Saving and Printing Data," starting on [page 253](#).

CAUTION

Only connect USB devices to the USB host port. Do not attempt to connect a host computer to this port to control the oscilloscope. Use the USB device port if you want to connect a host (See the *Oscilloscope Programmer's Quick Start Guide* for details).

4. Probe Compensation Terminals Use the signal at these terminals to match each probe's characteristics to the oscilloscope channel to which it is connected. See [page 38](#).

5. Vertical Position Control Use this knob to change the channel's vertical position on the display. There is one Vertical Position control for each channel. See "Using the channels" on [page 60](#).

6. Channel On/Off Key Use this key to switch the channel on or off, or to access the channel's menu in the softkeys. There is one Channel On/Off key for each channel. See [“Using the channels”](#) on page 60.

7. Math Key The Math key provides access to FFT (Fast Fourier Transform), multiply, subtract, differentiate, and integrate functions. See [“Math Functions”](#) on page 155.

8. Vertical Sensitivity Use this knob to change the vertical sensitivity (gain) of the channel. See [“Using the channels”](#) on page 60.

9. AutoProbe Interface (When you connect a probe to the oscilloscope, the AutoProbe Interface attempts to determine the type of probe and set its parameters in the Probe menu accordingly. See [page 58](#).

10. Channel Input BNC Connector Attach the oscilloscope probe or BNC cable to the BNC connector. This is the channel's input connector.

11. Label Key Press this key to access the Label menu, which lets you enter labels to identify each trace on the oscilloscope display. See [page 74](#).

12. File Keys Press the File key to access file functions such as save or recall a waveform or setup. Or press the Print key (labeled “Quick Print” on older models) to print the waveform from the display. See [“Saving and Printing Data”](#) on page 253.

13. Utility Key Press this key to access the Utility menu, which lets you configure the oscilloscope's I/O settings, printer configuration, file explorer, service menu, and other options.

14. Trigger Controls These controls determine how the oscilloscope triggers to capture data. See [“Choosing Auto trigger mode or Normal trigger mode”](#) on page 56 and [Chapter 3](#), [“Triggering the Oscilloscope,”](#) starting on page 89.

15. Run Controls Press Run/Stop to make the oscilloscope begin looking for a trigger. The Run/Stop key will illuminate in green. If the trigger mode is set to “Normal,” the display will not update until a trigger is found. If the trigger mode is set to “Auto,” the oscilloscope looks for a trigger, and if none is found, it will automatically trigger, and the display will immediately show the input signals. In this case, the **Auto** indicator at the top of the display will change to **Auto?** and the background will flash, indicating that the oscilloscope is forcing triggers.

Press Run/Stop again to stop acquiring data. The key will illuminate in red. Now you can pan across and zoom-in on the acquired data.

Press Single to make a single acquisition of data. The key will illuminate in yellow until the oscilloscope triggers. See [“To start and stop an acquisition”](#) on page 53.

16. Waveform Keys The Acquire key lets you set the oscilloscope to acquire in Normal, Peak Detect, Averaging, or High Resolution modes (see [“Acquisition Modes”](#) on page 209), and lets you turn Realtime sampling off or on (see [page 214](#)). The Display key lets you access the menu where you can select infinite persistence (see [page 205](#)), switch vectors on or off (see [page 206](#)), and adjust the display grid (graticule) intensity (see [page 206](#)).

17. Horizontal Position Control Turn the knob marked ◀▶ to pan through the waveform data horizontally. You can see the captured waveform before the trigger (turn the knob clockwise) or after the trigger (turn the knob counterclockwise). If you pan through the waveform when the oscilloscope is stopped (not in Run mode) then you are looking at the waveform data from the last acquisition taken. See [“To set up the Horizontal time base”](#) on page 65.

18. Horizontal Menu/Zoom Key (Labeled **Main/Delayed** on older models.) Press this key to access the menu where you can split the oscilloscope display into Main and Zoom sections, and where you can select XY and Roll modes. You can also select

horizontal time/division vernier and select the trigger time reference point on this menu. See [“To set up the Horizontal time base”](#) on page 65.

19. Horizontal Sweep Speed Control Turn the knob in the Horizontal section that is marked  to adjust the sweep speed. The symbols under the knob indicate that this control has the effect of spreading out or zooming in on the waveform using the horizontal scale. The horizontal sweep speed control changes the time per horizontal division on the display. See [“To set up the Horizontal time base”](#) on page 65.

20. Measure Keys Press the Cursors key to switch on cursors that you can use for making measurements. Press the **Quick Meas** key to access a set of predefined measurements. See [Chapter 4, “Making Measurements,”](#) starting on page 149.

21. Display The display shows captured waveforms using a different color for each channel. For more information about display modes see [Chapter 5, “Displaying Data,”](#) starting on page 201. Signal detail is displayed using 256 levels of intensity. For more information about viewing signal detail see [“Varying the intensity to view signal detail”](#) on page 208.

22. Entry Knob The entry knob is used to select items from menus and to change values. Its function changes based upon which menu is displayed. Note that the curved arrow symbol  above the entry knob illuminates whenever the entry knob can be used to select a value. Use the entry knob to select among the choices that are shown on the softkeys.

23. AutoScale Key When you press the AutoScale key the oscilloscope will quickly determine which channels have activity, and it will turn these channels on and scale them to display the input signals. See [“How AutoScale Works”](#) on page 251

24. Softkeys The functions of these keys change based upon the menus shown on the display directly above the keys.

2-Channel InfiniiVision 5000 Series Oscilloscope Front Panel (differences only)

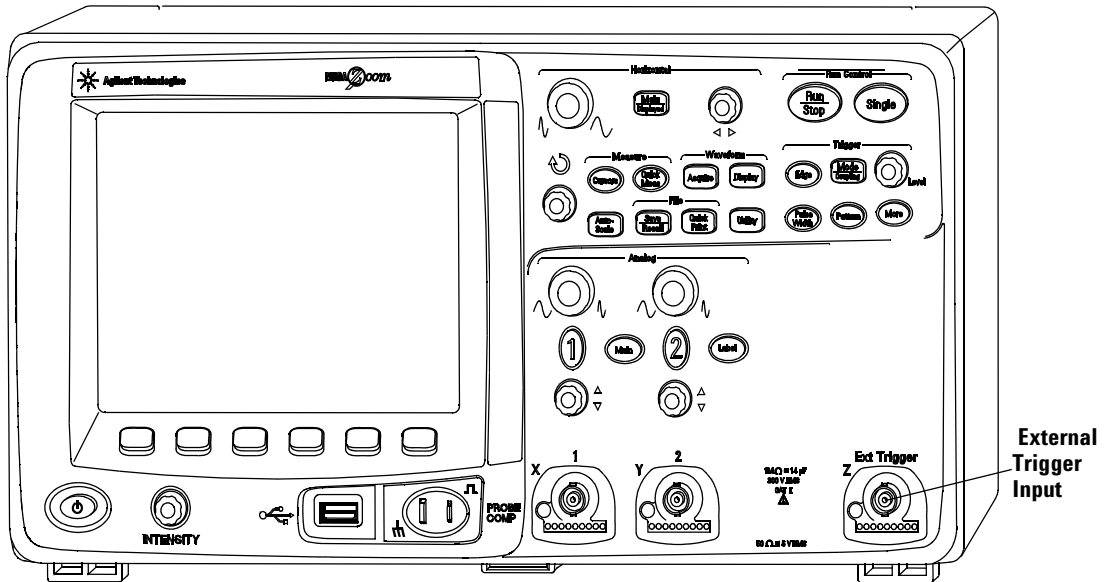

Figure 2 InfiniiVision 5000 Series 2-Channel Oscilloscope Front Panel

The differences between the front panel of the 4-channel oscilloscopes and the 2-channel oscilloscopes are:

- The 2-channel oscilloscope has two sets of channel controls
- The 2-channel oscilloscope's external trigger input is on the front panel instead of the rear panel. Some trigger features differ. See [“The External Trigger input”](#) on page 97.

Interpreting the display

The oscilloscope display contains acquired waveforms, setup information, measurement results, and softkeys for setting up parameters.



Figure 3 Interpreting the display

Status line The top line of the display contains vertical, horizontal, and trigger setup information.

Display area The display area contains the waveform acquisitions, channel identifiers, and trigger and ground level indicators. Each channel's information appears in a different color.

Measurement line This line normally contains automatic measurement and cursor results, but can also display advanced trigger setup data and menu information.

Softkeys The softkeys let you set up additional parameters for the selected mode or menu.

Front-Panel Operation

This section provides a brief overview of operating the front-panel controls. Detailed oscilloscope operating instructions are provided in later chapters.

To adjust the waveform intensity

The Intensity control is at the lower left corner of the front panel near the power switch.

- Rotate the **Intensity** control clockwise to increase the intensity of displayed waveforms, or counter-clockwise to decrease intensity. For more information see [“Varying the intensity to view signal detail”](#) on page 208.

To adjust the display grid (graticule) intensity

- 1 Press the **Display** key.
- 2 Turn the Entry knob  to change the intensity of the displayed grid. The intensity level is shown in the **Grid** softkey and is adjustable from 0 to 100%.

Each major vertical division in the grid corresponds to the vertical sensitivity shown in the status line at the top of the display.

Each major horizontal division in the grid corresponds to the sweep speed time shown in the status line at the top of the display.

To start and stop an acquisition

- When you press the **Run/Stop** key, it illuminates in green and the oscilloscope is in continuous running mode.

The oscilloscope examines the input voltage at each probe, and updates the display whenever the trigger conditions are met. Trigger processing and screen update rate are optimized based on the oscilloscope settings. The oscilloscope displays multiple acquisitions of the same signal similar to the way an analog oscilloscope displays waveforms.

- When you press the **Run/Stop** key again, it illuminates in red, and the oscilloscope is stopped.

“Stop” is displayed in the trigger mode position in the status line at the top of the display. You can pan and zoom the stored waveform by turning the horizontal and vertical control knobs.

- When controlling the oscilloscope through its Web interface (see Remote Front Panel on [page 29](#)) select **Run Control** from the Main Menu or press ctrl+R for run/stop or ctrl+S for single.

When the oscilloscope is running and you press the **Run/Stop** key, it will flash until the current acquisition is completed. If the acquisition completes immediately, the **Run/Stop** key will not flash.

At slower sweep speeds, you may not want to wait for the acquisition to finish. Just press **Run/Stop** again. The acquisition will stop immediately and a partial waveform will be displayed.

You can display the results of multiple acquisitions using infinite persistence. See “[Infinite persistence](#)” on page 205.

Memory Depth/Record Length

Run/Stop versus Single

When the oscilloscope is running, the trigger processing and update rate are optimized over the memory depth.

Single

Single acquisitions always use the maximum memory available—at least twice as much memory as acquisitions captured in Run mode—and the oscilloscope stores at least twice as many samples. At slow sweep speeds, the oscilloscope operates at a higher sample rate when Single is used to capture an acquisition due to the increased memory available. To acquire data with the longest possible record length, press the **Single** key.

Running

When running, versus taking a single acquisition, the memory is divided in half. This allows the acquisition system to acquire one record while processing the previous acquisition, dramatically improving the number of waveforms per second processed by the oscilloscope. While running, maximizing the rate at which waveforms are drawn on the display provides the best picture of your input signal.

To make a single acquisition

When you press the **Single** key it illuminates in yellow and the oscilloscope starts the acquisition system, searching for the trigger condition. When the trigger condition is met, the captured waveform is displayed, the **Single** key is extinguished and the **Run/Stop** key illuminates in red.

- Use the **Single** key to view single-shot events without subsequent waveform data overwriting the display.

Use Single when you want the maximum sample rate and the maximum memory depth for pan and zoom. (See “[To pan and zoom](#)” on page 56)

- 1 Set the trigger mode to Normal (see “[Trigger modes: Normal and Auto](#)” on page 92 for instructions).

This keeps the oscilloscope from automatically triggering immediately.

- 2 If you are triggering on oscilloscope channel events, turn the Trigger Level knob to the trigger threshold to a level that your waveform will cross.
- 3 To begin a single acquisition, press the **Single** key.

When you press **Single**, the display is cleared, the trigger circuitry is armed, the **Single** key is illuminated yellow, and the oscilloscope will wait until a trigger condition occurs before it displays a waveform.

When the oscilloscope triggers, the single acquisition is displayed and the oscilloscope is stopped (the **Run/Stop** key is illuminated in red).

- 4 To acquire another waveform, press **Single** again.

Auto Trigger Mode and Single

In Auto trigger mode the oscilloscope will generate a trigger for you if one is not found in the predetermined time (about 40 ms) after you press **Single**. If you want to make a single acquisition and you are not particularly interested in triggering the acquisition (for example, if you are probing a DC level), set the

trigger mode to Auto (see [page 92](#)) and press the **Single** key. If a trigger condition occurs within about 40 ms, it will be used; if a trigger doesn't occur, an untriggered acquisition will be taken.

To pan and zoom

You can pan across and zoom-in on a waveform even when the acquisition system is stopped.

- 1 Press the **Run/Stop** key to stop acquisitions (or press the **Single** key and allow the oscilloscope to acquire the waveform and stop). The **Run/Stop** key is illuminated red when the oscilloscope is stopped.
- 2 Turn the sweep speed knob to zoom horizontally and turn the volts/division knob to zoom vertically.

The ∇ symbol at the top of the display indicates the time reference point where the zoom-in/zoom-out is referenced.

- 3 Turn the Horizontal Position knob (◀▶) to pan horizontally and turn the channel's vertical position knob (⬆️⬇️⬆️) to pan vertically.

The stopped display may contain several triggers worth of information, but only the last trigger acquisition is available for pan and zoom.

For more information about Pan and Zoom see [page 202](#).

Choosing Auto trigger mode or Normal trigger mode

In Auto trigger mode the oscilloscope will generate a trigger for you if one is not found in a predetermined amount of time (based on the selected sweep speed) after you press **Run**. If you are probing a DC level and you want to see it displayed, set the trigger mode to Auto (see [page 92](#)). If a trigger condition occurs, it will be used; if a trigger doesn't occur, an untriggered acquisition will be taken.

If you press **Run** when the oscilloscope is in Normal trigger mode, a trigger must be detected before the oscilloscope displays an acquisition.

In many cases, a triggered display is not needed to check signal levels or activity. For these applications, use Auto trigger mode (which is the default setting). If you only want to acquire specific events as specified by the trigger settings, use Normal trigger mode.

You can select the trigger mode by pressing the **Mode/Coupling** key, then the **Mode** softkey.

For more detailed discussion of Auto trigger mode and Normal trigger mode, see [“Trigger modes: Normal and Auto”](#) on page 92.

Using AutoScale

To configure the oscilloscope quickly, press the **AutoScale** key to display the connected signal(s) that are active.

To undo the effects of AutoScale, press the **Undo AutoScale** softkey before pressing any other key. This is useful if you have unintentionally pressed the **AutoScale** key or do not like the settings AutoScale has selected and want to return to your previous settings.

To make the oscilloscope remain in the acquisition mode you have chosen, press the **AutoScale Acq Mode** softkey and select **Preserve Acquisition Mode**. Otherwise, the acquisition mode will default to **Normal** whenever the **AutoScale** key is pressed.

See also [“How AutoScale Works”](#) on page 251.

Example exercise

Example

Connect the oscilloscope probes for channels 1 and 2 to the Probe Comp output on the front panel of the instrument. Be sure to connect the probe ground leads to the ground lug beside the Probe Comp output. Set the instrument to the factory

default configuration by pressing the **Save/Recall** key, then the **Default Setup** softkey. Then press the **AutoScale** key. You should see a display similar to the one shown below.

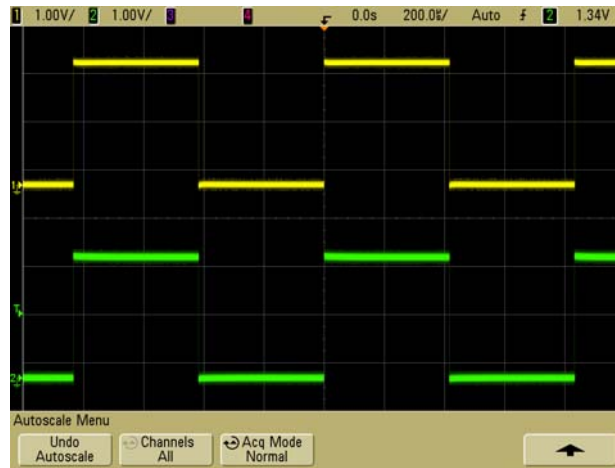

Figure 4 AutoScale of oscilloscope channels 1 and 2

If the waveforms are not perfectly square, you may need to set the probe compensation as described on [page 38](#).

To set the probe attenuation factor

Passive Probes

InfiniiVision 5000 Series oscilloscopes recognize passive probes such as the N2863A, 10073C and 10074C. These probes have a pin on their connector that connects to the ring around the oscilloscope's BNC connector. Therefore, the oscilloscope will automatically set the attenuation factor for recognized Agilent passive probes.

Passive probes that do not have a pin that connects to the ring around the BNC connector will not be recognized by the oscilloscope, and you must set the probe attenuation factor manually.

Manually Setting the Probe Attenuation Factor

If you connect a probe that the oscilloscope does not automatically identify, you can set the attenuation factor as follows:

- 1 Press the channel key
- 2 Press the **Probe** softkey
- 3 Turn the Entry knob  to set the attenuation factor for the connected probe.

The attenuation factor can be set from 0.1:1 to 1000:1 in a 1-2-5 sequence for measuring voltage values. The attenuation factor can be set from 10 V/A to 0.001V/A to for measuring current values with a current probe. The probe attenuation factor must be set properly for measurements to be made correctly.

Active Probes

All InfiniiVision 5000 Series oscilloscopes have an AutoProbe interface. Most Agilent active probes are compatible with the AutoProbe interface. The AutoProbe interface uses a series of contacts directly below the channel's BNC connector to transfer information between the oscilloscope and the probe. When you connect a compatible probe to the oscilloscope, the AutoProbe interface determines the type of probe and sets the oscilloscope's parameters (units, offset, attenuation, coupling, and impedance) accordingly.

Using the channels

Connect the oscilloscope probes for channels 1 and 2 to the Probe Comp output on the front panel of the instrument.

- 1 Press the **1** key on the oscilloscope's front panel to display the Channel 1 menu.

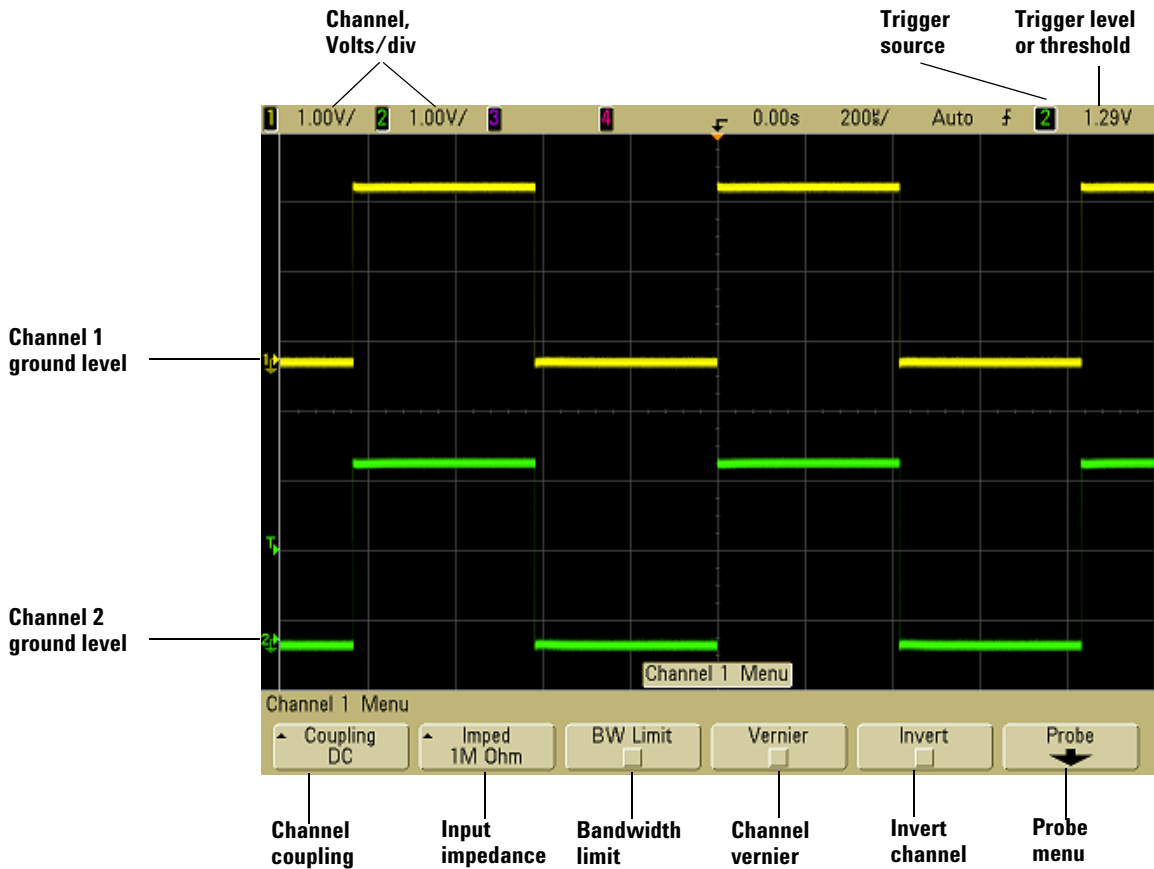

Pressing a channel key displays the channel's menu and turns the display of the channel on or off. The channel is displayed when the key is illuminated.

Turning channels off

You must be viewing the menu for a channel before you can turn it off. For example, if channel 1 and channel 2 are turned on and the menu for channel 2 is being displayed, to turn channel 1 off, press **1** to display channel 1 menu, then press **1** again to turn channel 1 off.



Vertical sensitivity Turn the large knob above the channel key to set the sensitivity (volts/division) for the channel. The vertical sensitivity knob changes the channel sensitivity in a 1-2-5 step sequence (with a 1:1 probe attached). The channel Volts/Div value is displayed in the status line.

Vernier Press the **Vernier** softkey to turn on vernier for the selected channel. When Vernier is selected, you can change the channel's vertical sensitivity in smaller increments. The channel sensitivity remains fully calibrated when Vernier is on. The sensitivity value is displayed in the status line at the top of the display.

When Vernier is turned off, turning the volts/division knob changes the channel sensitivity in a 1-2-5 step sequence.

Vertical expansion The default mode for expanding the signal when you turn the volts/division knob is vertical expansion about the ground level of the channel. To set the expansion mode to expand about the center of the screen instead, press **Expand** in the **Utility**→**Options**→**Preferences** menu and select **Center**. See also [page 81](#).

Ground level The ground level of the signal for each displayed channel is identified by the position of the  icon at the far-left side of the display.

Vertical position Turn the small vertical position knob () to move the channel's waveform up or down on the display. The voltage value momentarily displayed in the upper right portion of the display represents the voltage difference between the vertical center of the display and the ground level () icon. It also represents the voltage at the vertical center of the display if vertical expansion is set to expand about ground.

Measurement Hints

If the channel is DC coupled, you can quickly measure the DC component of the signal by simply noting its distance from the ground symbol.

If the channel is AC coupled, the DC component of the signal is removed, allowing you to use greater sensitivity to display the AC component of the signal.

- 2 Press the channel's on/off key, then press the **Coupling** softkey to select the input channel coupling.

Coupling changes the channel's input coupling to either **AC** (alternating current) or **DC** (direct current). AC coupling places a 3.5 Hz high-pass filter in series with the input waveform that removes any DC offset voltage from the waveform. When **AC** is selected, "AC" is illuminated on the front panel next to the channel position knob (◆).

- DC coupling is useful for viewing waveforms as low as 0 Hz that do not have large DC offsets.
- AC coupling is useful for viewing waveforms with large DC offsets. When AC coupling is chosen, you cannot select 50Ω mode. This is done to prevent damage to the oscilloscope.

Note that Channel Coupling is independent of Trigger Coupling. To change Trigger coupling see [page 94](#).

- 3 Press the **Imped** (impedance) softkey.

NOTE

When you connect an AutoProbe, self-sensing probe, or a compatible InfiniiMax probe, the oscilloscope will automatically configure the oscilloscope to the correct impedance.

The oscilloscope channel input impedance can be set to either **1M Ohm** or **50 Ohm** by pressing the **Imped** softkey.

- **50 Ohm** mode matches 50-ohm cables commonly used in making high frequency measurements, and 50-ohm active probes. This impedance matching gives you the most accurate measurements since reflections are minimized along the signal path. When **50 Ohm** is selected, “50Ω” is illuminated on the front panel next to the channel position knob. The oscilloscope automatically switches to **1 M Ohm** mode to prevent possible damage if AC coupling is selected.
- **1M Ohm** mode is for use with many passive probes and for general-purpose measurements. The higher impedance minimizes the loading effect of the oscilloscope on the circuit under test.

4 Press the **BW Limit** softkey to turn on bandwidth limiting.

Pressing the **BW Limit** softkey turns the bandwidth limit on or off for the selected channel. When bandwidth limit is on, the maximum bandwidth for the channel is approximately 25 MHz. For waveforms with frequencies below this, turning bandwidth limit on removes unwanted high frequency noise from the waveform. The bandwidth limit also limits the trigger signal path of any channel that has **BW Limit** turned on.

When **BW Limit** is selected, “BW” is illuminated on the front panel next to the channel position knob (◆).

5 Press the **Invert** softkey to invert the selected channel.

When **Invert** is selected, the voltage values of the displayed waveform are inverted. **Invert** affects how a channel is displayed, but does not affect triggering. If the oscilloscope is set to trigger on a rising edge, it remains set to trigger on a same edge (triggers at the same point on the waveform) after the channel is inverted.

Inverting a channel will also change the result of any function selected in the **Math** menu or any measurement.

6 Press the **Probe** softkey to display the channel probe menu.

This menu lets you select additional probe parameters such as attenuation factor and units of measurement for the connected probe.

Probe calibration not needed, not available when this softkey is ghosted.

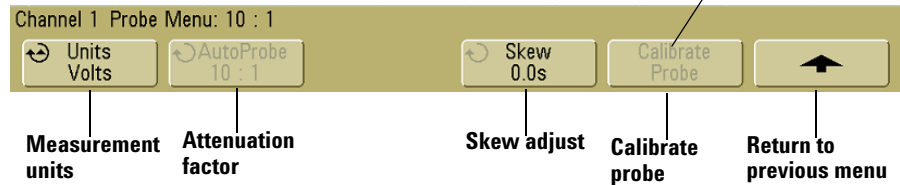

- **Probe Units** – Press the **Units** softkey to select the proper measurement unit for the connected probe. Select **Volts** for a voltage probe and select **Amps** for a current probe. Channel sensitivity, trigger level, measurement results, and math functions will reflect the measurement units you have selected.
- **Probe Attenuation Factor**– See “[To set the probe attenuation factor](#)” on page 58.
- **Skew** – When measuring time intervals in the ns range, small differences in cable length can affect the measurement. Use **Skew** to remove cable-delay errors between any two channels.

Probe the same point with both probes, then press **Skew** and turn the Entry knob to enter the amount of skew between channels. Each channel can be adjusted ± 100 ns in 10 ps increments for a total of 200 ns difference.

The skew setting is reset to zero when you press **Save/Recall**→**Default Setup**.

- **Probe Units** – Press the **Units** softkey to select the proper measurement unit for the connected probe. Select **Volts** for a voltage probe and select **Amps** for a current probe. Channel sensitivity, trigger level, measurement results, and math functions will reflect the measurement units you have selected.
- **Calibrate Probe** – See “[To calibrate the probes](#)” on page 39.

To set up the Horizontal time base

- 1 Press the **Menu/Zoom** key (labeled **Main/Delayed** on older models) in the Horizontal section of the front panel.

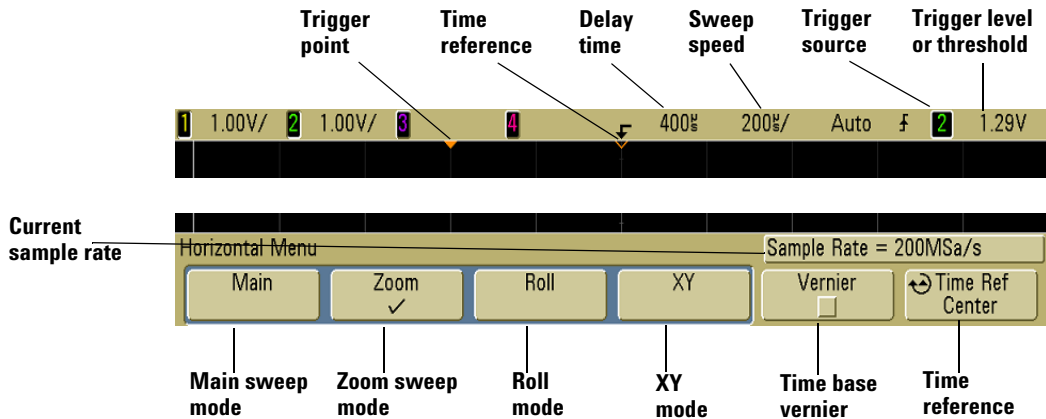

The Horizontal menu lets you select the horizontal mode (Main, Zoom, Roll, or XY), and set the time base vernier and time reference.

The current sample rate is displayed above the **Vernier** and **Time Ref** softkeys.

Main mode

- 1 Press the **Main** softkey to select Main horizontal mode.

Main horizontal mode is the normal viewing mode for the oscilloscope. When the oscilloscope is stopped, you can use the Horizontal knobs to pan and zoom the waveform.

- 2 Turn the large knob (time/division) in the Horizontal section and notice the change it makes to the status line.

When the oscilloscope is running in Main mode, use the large Horizontal knob to change sweep speed and use the small knob (◀▶) to set the horizontal position. When the

oscilloscope is stopped, use these knobs to pan and zoom your waveform. The sweep speed (seconds/division) value is displayed in the status line.

- 3 Press the **Vernier** softkey to turn on the time base vernier.

The **Vernier** softkey lets you change the sweep speed in smaller increments with the time/division knob. The sweep speed remains fully calibrated when Vernier is on. The value is displayed in the status line at the top of the display.

When Vernier is turned off, the Horizontal sweep speed knob changes the time base sweep speed in a 1-2-5 step sequence.

- 4 Note the setting of the **Time Ref** (time reference) softkey.

Time reference is the reference point on the display for horizontal position (also called delay time). Time reference can be set to one major division from the left or right edge, or to the center of the display.

A small hollow triangle (∇) at the top of the display grid marks the position of the time reference. When horizontal position is set to zero, the trigger point indicator (\blacktriangledown) overlays the time reference indicator.

Turning the Horizontal sweep speed knob will expand or contract the waveform about the time reference point (∇). Turning the horizontal position ($\blacktriangleleft\blacktriangleright$) knob in Main mode will move the trigger point indicator (\blacktriangledown) to the left or right of the time reference point (∇).

The time reference position sets the initial position of the trigger event within acquisition memory and on the display, with delay (horizontal position) set to 0. The horizontal position setting sets the specific location of the trigger event with respect to the time reference position. The time reference setting affects the Zoom sweep as described in the following ways:

- When the horizontal mode is set to Main, the horizontal position knob positions the main sweep relative to the trigger. This delay is a fixed number. Changing this delay value does not affect the sweep speed.

- When the horizontal mode is set to Zoom, the horizontal position knob controls the position of the Zoom sweep window inside the main sweep display. This delay value is independent of sampling interval and sweep speed. Changing the delay does not affect the position of the main window.
- 5 Turn the horizontal position knob (◀▶) and notice that its value is displayed in the status line.

The horizontal position knob moves the main sweep horizontally, and it pauses at 0.00 s, mimicking a mechanical detent. Changing the horizontal position moves the sweep horizontally and indicates how far the trigger point (solid inverted triangle) is from the time reference point (hollow inverted triangle ▽). These reference points are indicated along the top of the display grid. The previous figure shows the trigger point with the delay time (horizontal position) set to 400 μ s. The delay time number tells you how far the time reference point is located from the trigger point. When delay time (horizontal position) is set to zero, the delay time indicator overlays the time reference indicator.

All events displayed left of the trigger point happened before the trigger occurred, and these events are called pre-trigger information. You will find this feature very useful because you can now see the events that led up to the trigger point. Everything to the right of the trigger point is called post-trigger information. The amount of delay range (pre-trigger and post-trigger information) available depends on the sweep speed selected and memory depth.

Zoom mode

Zoom sweep is an expanded version of main sweep. When Zoom mode is selected, the display divides in half and the Zoom sweep  icon displays in the middle of the line at the top of the display. The top half of the display shows the main sweep and the bottom half displays the Zoom sweep.

Zoom sweep is a magnified portion of the main sweep. You can use Zoom sweep to locate and horizontally expand part of the main sweep for a more detailed (higher-resolution) analysis of signals.

The following steps show you how to use Zoom sweep. Notice that the steps are very similar to operating the “delayed sweep” in analog oscilloscopes.

- 1 Connect a signal to the oscilloscope and obtain a stable display.
- 2 Press **Menu/Zoom**.
- 3 Press the **Zoom** softkey.

To change the sweep speed for the Zoom sweep window, turn the sweep speed knob. As you turn the knob, the sweep speed is highlighted in the status line above the waveform display area.

The area of the main display that is expanded is intensified and marked on each end with a vertical marker. These markers show what portion of the main sweep is expanded in the lower half. The Horizontal knobs control the size and position of the Zoom sweep. The delay value is momentarily displayed in the upper-right portion of the display when the horizontal position (◀▶) knob is turned.

To change the sweep speed for the main sweep window, press the **Main** softkey, then turn the sweep speed knob.

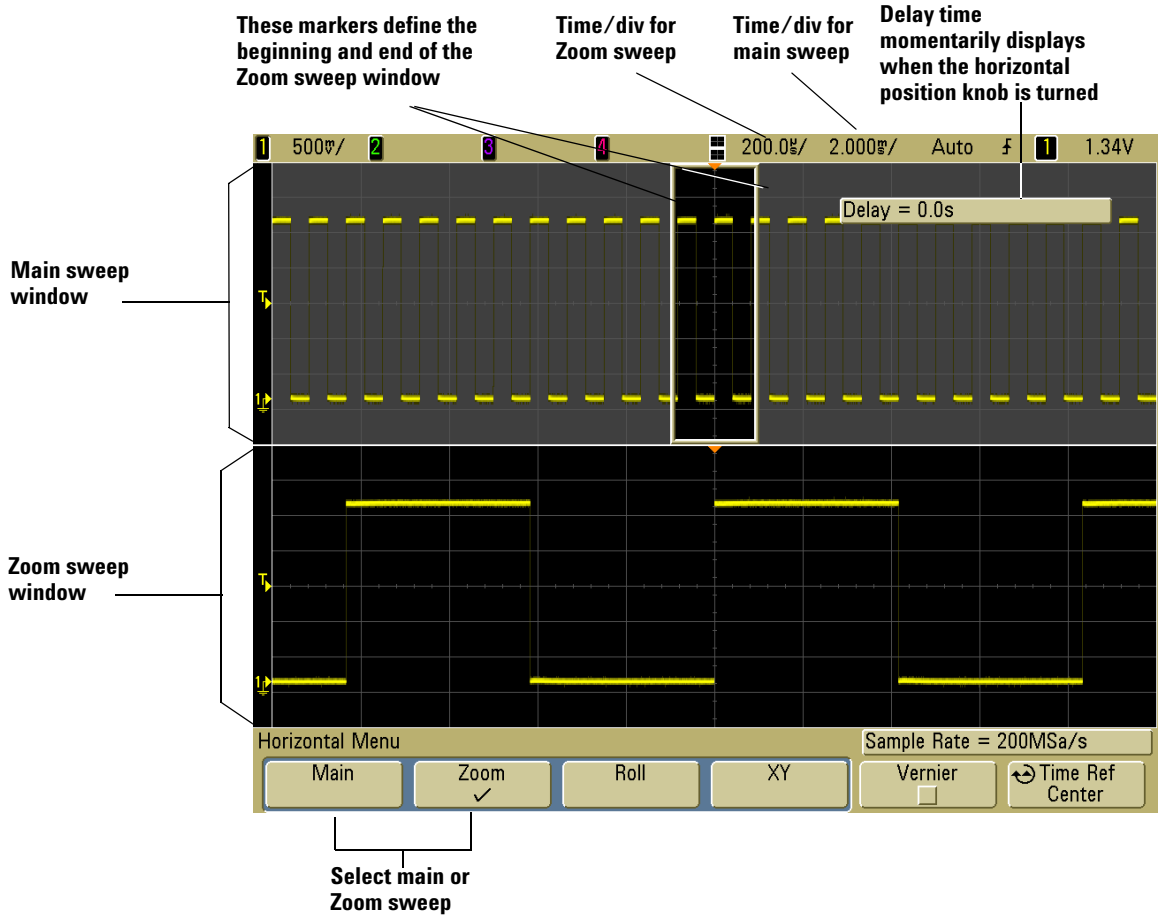

The area of the main display that is expanded is intensified and marked on each end with a vertical marker. These markers show what portion of the main sweep is expanded in the lower half. The Horizontal knobs control the size and position of the Zoom sweep. The delay value is momentarily displayed in the upper-right portion of the display when the horizontal position (◀▶) knob is turned.

To change the sweep speed for the Zoom sweep window, turn the sweep speed knob. As you turn the knob, the sweep speed is highlighted in the status line above the waveform display area.

The time reference position sets the initial position of the trigger event within acquisition memory and on the display, with delay (horizontal position) set to 0. The delay setting sets the specific location of the trigger event with respect to the time reference position. The time reference setting affects the Zoom sweep in the following ways.

When the horizontal mode is set to Main, the horizontal position knob positions the main sweep relative to the trigger. This delay is a fixed number. Changing this delay value does not affect the sweep speed. When the horizontal mode is set to Zoom, the delay controls the position of the Zoom sweep window inside the main sweep display. This delay value is independent of sampling interval and sweep speed.

To change the sweep speed for the main sweep window, press the **Main** softkey, then turn the sweep speed knob.

For information about using Zoom mode for measurements, refer to [Chapter 4](#), “Making Measurements,” starting on page 149.

Roll mode

- Press the **Menu/Zoom** key, then press the **Roll** softkey.
- Roll mode causes the waveform to move slowly across the screen from right to left. It only operates on time base settings of 500 ms/div and slower. If the current time base setting is faster than the 500 ms/div limit, it will be set to 500 ms/div when Roll mode is entered.
- In Normal horizontal mode, signal events occurring before the trigger are plotted to the left of the trigger point (t) and signal events after the trigger plotted to the right of the trigger point.

- In Roll mode there is no trigger. The fixed reference point on the screen is the right edge of the screen and refers to the current moment in time. Events that have occurred are scrolled to the left of the reference point. Since there is no trigger, no pre-trigger information is available.

If you would like to pause the display in Roll mode press the **Single** key. To clear the display and restart an acquisition in Roll mode, press the **Single** key again.

Use Roll mode on low-frequency waveforms to yield a display much like a strip chart recorder. It allows the waveform to roll across the display.

XY mode

XY mode changes the display from a volts-versus-time display to a volts-versus-volts display. The time base is turned off. Channel 1 amplitude is plotted on the X-axis and Channel 2 amplitude is plotted on the Y-axis.

You can use XY mode to compare frequency and phase relationships between two signals. XY mode can also be used with transducers to display strain versus displacement, flow versus pressure, volts versus current, or voltage versus frequency.

Use the cursors to make measurements on XY mode waveforms.

For more information about using XY mode for measurements, refer to [“To use the XY horizontal mode”](#) on page 150.

Z-Axis Input in XY Display Mode (Blanking)

When you select the XY display mode, the time base is turned off. Channel 1 is the X-axis input, channel 2 is the Y-axis input, and channel 4 (or the External trigger on 2-channel models) is the Z-axis input. If you only want to see portions of the Y versus X display, use the Z-axis input. Z-axis turns the trace on and off (analog oscilloscopes called this Z-axis blanking because it turned the beam on and off). When Z is low (<1.4 V), Y versus X is displayed; when Z is high (>1.4 V), the trace is turned off.

To make cursor measurements

You can use the cursors to make custom voltage or time measurements on oscilloscope signals.

- 1 Connect a signal to the oscilloscope and obtain a stable display.
- 2 Press the **Cursors** key. View the cursor functions in the softkey menu:
 - **Mode** – Set the cursors to measure voltage and time (Normal), or display the binary or hexadecimal logic value of the displayed waveforms.
 - **Source** – selects a channel or math function for the cursor measurements.
 - **X Y** – Select either the X cursors or the Y cursors for adjustment with the Entry knob.
 - **X1** and **X2** – adjust horizontally and normally measure time.
 - **Y1** and **Y2** – adjust vertically and normally measure voltage.
 - **X1 X2** and **Y1 Y2** – move the cursors together when turning the Entry knob.

NOTE

If you intend to make cursor measurements on a trace that you recall from memory, be sure to recall both setup and trace. See [“To recall waveform trace and/or oscilloscope setup”](#) on page 266.

For more information about using the cursors, see [“To make cursor measurements”](#) on page 174.

To make automatic measurements

You can use automatic measurements on any channel source or any running math function. Cursors are turned on to focus on the most recently selected measurement (right-most on the measurement line above the softkeys on the display).

- 1 Press the **Quick Meas** key to display the automatic measurement menu.
- 2 Press the **Source** softkey to select the channel or running math function to be measured.

Only channels or math functions that are displayed are available for measurements. If you choose an invalid source channel for a measurement, the measurement will default to the nearest in the list that makes the source valid.

If a portion of the waveform required for a measurement is not displayed or does not display enough resolution to make the measurement, the result will be displayed with a message such as greater than a value, less than a value, not enough edges, not enough amplitude, incomplete, or waveform is clipped to indicate that the measurement may not be reliable.

- 3 Choose a type of measurement by pressing the **Select** softkey, then turn the Entry knob  to select the desired measurement from the popup list.
- 4 Press the **Measure** softkey to make the selected measurement.
- 5 To stop making measurements and erase the measurement results from the measurement line above the softkeys, press the **Clear Meas** softkey.

For more information about automatic measurements, see [“Automatic Measurements”](#) on page 181.

Using Labels

You can define labels and assign them to each input channel, or you can turn labels off to increase the waveform display area.

To turn the label display on or off

- 1 Press the **Label** key on the front panel.

This turns on display labels for the channels. When the **Label** key is illuminated, the labels for displayed channels are displayed at the left edge of the displayed traces. The channel labels default to their channel number. The figure below shows an example of the label “CHAN 1” assigned to Channel 1.



- 2 To turn the labels off, press the **Label** key until it is not illuminated.

To assign a predefined label to a channel

- 1 Press the **Label** key.
- 2 Press the **Channel** softkey, then turn the Entry knob or successively press the **Channel** softkey to select a channel for label assignment.

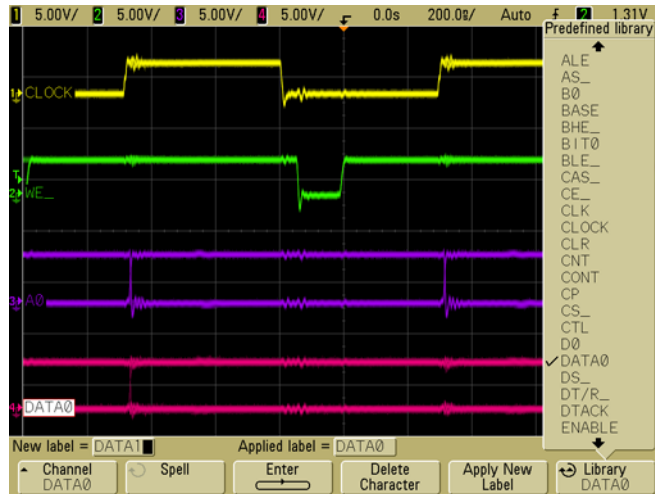

The channel does not have to be turned on to have a label assigned to it.

- 3 Press the **Library** softkey, then turn the Entry knob or successively press the **Library** softkey to select a predefined label from the library.
- 4 Press the **Apply New Label** softkey to assign the label to your selected channel.
- 5 Repeat the above procedure for each predefined label you want to assign to a channel.

To define a new label

- 1 Press the **Label** key.
- 2 Press the **Channel** softkey, then turn the Entry knob or successively press the softkey to select a channel for label assignment.

The channel does not have to be turned on to have a label assigned to it. If the channel is turned on, its current label will be highlighted.

- 3 Press the **Spell** softkey, then turn the Entry knob to select the first character in the new label.

Turning the Entry knob selects a character to enter into the highlighted position shown in the "**New label =**" line above the softkeys and in the **Spell** softkey. Labels can be up to six characters in length.

- 4 Press the **Enter** softkey to enter the selected character and to go to the next character position.

You may position the highlight on any character in the label name by successively pressing the **Enter** softkey.

- 5 To delete a character from the label, press the **Enter** softkey until the letter you want to delete is highlighted, then press the **Delete Character** softkey.
- 6 When you are done entering characters for the label, press the **Apply New Label** softkey to assign the label to the selected channel.

When you define a new label, it is added to the nonvolatile label list.

Label Assignment Auto-Increment Features

When you assign a label ending in a digit, such as ADDR0 or DATA0, the oscilloscope automatically increments the digit and displays the modified label in the "New label" field after you press the **Apply New Label** softkey. Therefore, you only need to select a new channel and press the **Apply New Label** softkey again to assign the label to the channel. Only the original label is saved in the label list. This feature makes it easier to assign successive labels to numbered control lines and data bus lines.

To load a list of labels from a text file you create

It may be convenient to create a list of labels using a text editor, then load the label list into the oscilloscope. This lets you type on a keyboard rather than edit the label list using the oscilloscope's controls.

You can create a list of up to 75 labels and load it into the oscilloscope. Labels are added to the beginning of the list. If more than 75 labels are loaded, only the first 75 are stored.

To load labels from a text file into the oscilloscope:

- 1 Use a text editor to create each label. Each label can be up to six characters in length. Separate each label with a line feed.
- 2 Name the file `labellist.txt` and save it on a USB mass storage device such as a thumb drive.
- 3 Load the list into the oscilloscope using the File Explorer (press **Utility**→**File Explorer**).

Label List Management

When you press the **Library** softkey, you will see a list of the last 75 labels used. The list does not save duplicate labels. Labels can end in any number of trailing digits. As long as the base string is the same as an existing label in the library, the new label will not be put in the library. For example, if label A0 is in the library and you make a new label called A12345, the new label is not added to the library. When you save a new user-defined label, the new label will replace the oldest label in the list. Oldest is defined as the longest time since the label was last assigned to a channel. Any time you assign any label to a channel, that label will move to the newest in the list. Thus, after you use the label list for a while, your labels will predominate, making it easier to customize the instrument display for your needs.

When you reset the label library list (see next topic), all of your custom labels will be deleted, and the label list will be returned to its factory configuration.

To reset the label library to the factory default

- 1 Press **Utility**→**Options**→**Preferences**.

CAUTION

Pressing the Default Library softkey will remove all user-defined labels from the library and set the labels back to the factory default. Once deleted, these user-defined labels cannot be recovered.

- 2 Press the **Default Library** softkey.

This will delete all user-defined labels from the library and set the labels in the library back to the factory default. However, this does not default the labels currently assigned to the channels (those labels that appear in the waveform area).

Defaulting labels without erasing the default library.

Selecting **Default Setup** in the **Save/Recall** menu will set all channel labels back to the default labels but does not erase the list of user-defined labels in the library.

To print the display

You can print the complete display, including the status line and softkeys, to a USB printer. Press the **Print** key (labeled **Quick Print** on older models), then press the **Press to Print** softkey. You can stop printing by pressing the **Cancel Print** softkey.

For more information on printing, see [“Printing the oscilloscope’s display”](#) on page 254.

To set the clock

The Clock menu lets you set the current date and time of day (24-hour format). This time/date stamp will appear on hardcopy prints and directory information on the USB mass storage device.

To set the date and time, or to view the current date and time:

1 Press **Utility**→**Options**→**Clock**.

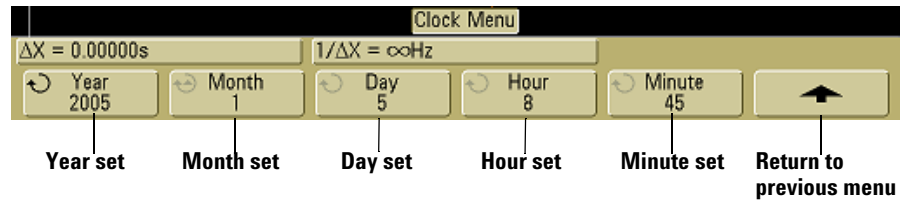

2 Press the **Year**, **Month**, **Day**, **Hour** or **Minute** softkey and rotate the Entry knob to set to the desired number.

The hours are shown in the 24-hour format. So 1:00 PM is hour 13.

The real-time clock only allows selection of valid dates. If a day is selected and the month or year is changed so the day is invalid, the day is automatically adjusted.

To set up the screen saver

The oscilloscope can be configured to turn on a display screen saver when the oscilloscope has been idle for a specified length of time.

- 1 Press **Utility**→**Options**→**Preferences**→**Screen Saver** to display the screen saver menu.

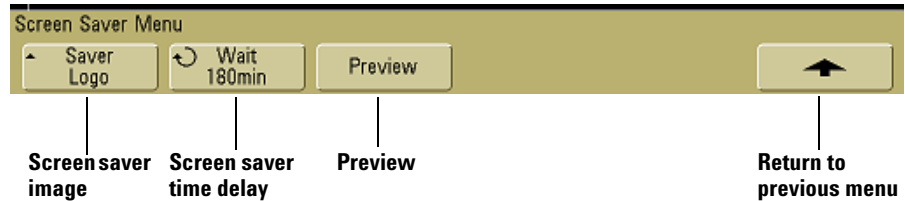

- 2 Press the **Saver** softkey to select the screen saver type.

The screen saver can be set to **Off**, to display any of the images shown in the list, or can display a user-defined text string.

If **User** is selected, press the **Spell** softkey to select the first character of the text string. Use the Entry knob to choose a character. Then press the **Enter** softkey to advance to the next character and repeat the process. The resultant string is displayed in the "Text =" line above the softkeys.

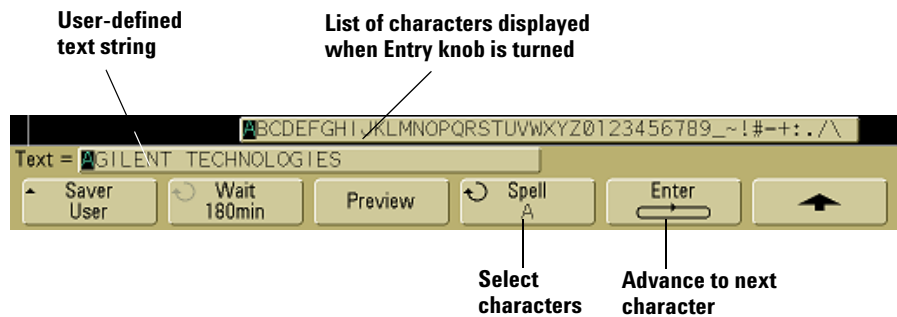

- 3 Turn the Entry knob to select the number of minutes to wait before the selected screen saver activates.

When you turn the Entry knob, the number of minutes is displayed in the **Wait** softkey. The default time is 180 minutes (3 hours).

- 4 Press the **Preview** softkey to preview the screen saver you have selected with the **Saver** softkey.
- 5 To view the normal display after the screen saver has started, press any key or turn any knob.

To set the waveform expansion reference point

- Press **Utility**→**Options**→**Preferences**→**Expand** and select **Ground** or **Center**.

When you change a channel's volts/division setting, the waveform display can be set to expand (or compress) about the signal ground level or the center of the display.

Expand About Ground The displayed waveform will expand about the position of the channel's ground. This is the default setting. The ground level of the signal is identified by the position of the ground level (⏏) icon at the far-left side of the display. The ground level will not move when you adjust the vertical sensitivity (volts/division) control.

If the ground level is off screen, the waveform will expand about the top or bottom edge of the screen based on where the ground is off screen.

Expand About Center The displayed waveform will expand about the center of the display.

To perform service functions

- Press the **Utility**→**Service** to display the service menu.

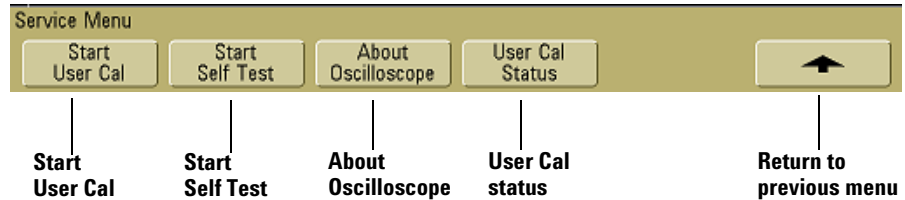

The Service Menu lets you:

- Perform User Cal on the oscilloscope.
- View User Cal status.
- Perform instrument Self Test.
- View information about your oscilloscope model number, code revision information, and User Cal status.

User Calibration

Perform user-calibration:

- Each year or after 2000 hours of operation.
- If the ambient temperature is $>10^{\circ}$ C from the calibration temperature.
- If you want to maximize the measurement accuracy.

The amount of use, environmental conditions, and experience with other instruments help determine if you need shorter User Cal intervals.

User Cal performs an internal self-alignment routine to optimize the signal path in the oscilloscope. The routine uses internally generated signals to optimize circuits that affect channel sensitivity, offset, and trigger parameters. Disconnect all inputs and allow the oscilloscope to warm up before performing this procedure.

Performing User Cal will invalidate your Certificate of Calibration. If NIST (National Institute of Standards and Technology) traceability is required, perform the Performance Verification procedure in the *Agilent InfiniiVision 5000 Series Oscilloscopes Service Guide* using traceable sources.

To perform User Cal

- 1 Set the rear-panel CALIBRATION switch to UNPROTECTED.
- 2 Connect short (12 inch maximum) equal length cables to each oscilloscope channel's BNC connector on the front of the oscilloscope. You will need two equal-length cables for a 2-channel oscilloscope or four equal-length cables for a 4-channel oscilloscope.

Use 50 Ω RG58AU or equivalent BNC cables when performing User Cal.

For a 2-channel oscilloscope, connect a BNC tee to the equal length cables. Then connect a BNC(f)-to-BNC(f) (also called a barrel connector) to the tee as shown below.

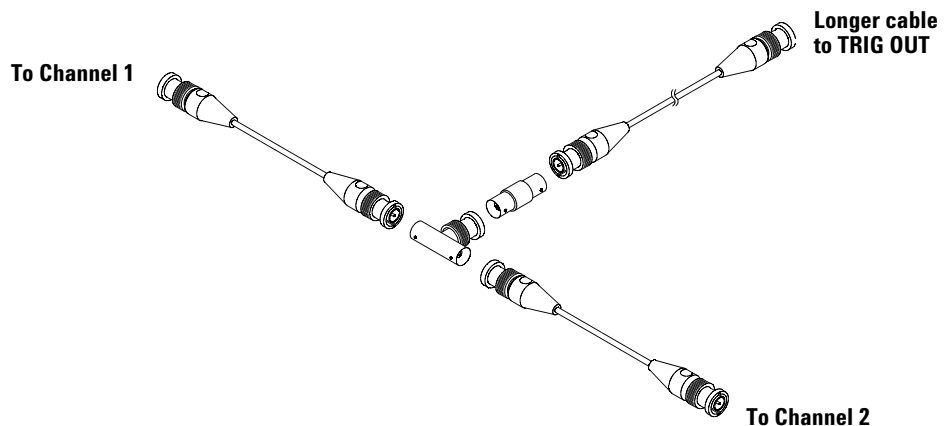

Figure 5 User Calibration cable for 2-channel oscilloscope

For a 4-channel oscilloscope, connect BNC tees to the equal-length cables as shown below. Then connect a BNC(f)-to-BNC(f) (barrel connector) to the tee as shown below.

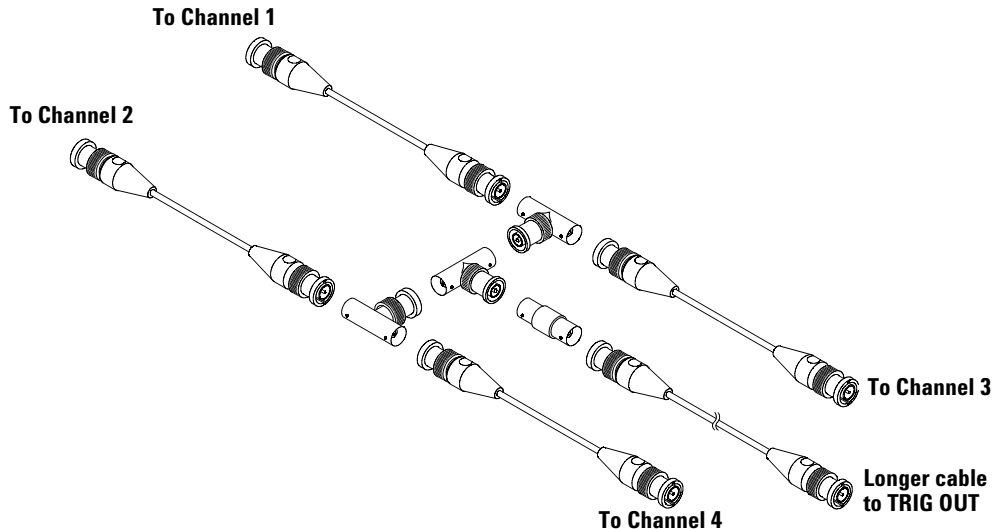

Figure 6 User Calibration cable for 4-channel oscilloscope

- 1 Connect a BNC cable (40 inches maximum) from the TRIG OUT connector on the rear panel to the BNC barrel connector.
- 2 Press the **Utility** key, then press the **Service** softkey.
- 3 Begin the Self Cal by pressing the **Start User Cal** softkey.
- 4 When the User Cal is completed, set the rear-panel CALIBRATION switch to PROTECTED.

User Cal Status

Pressing **Utility**→**Service**→**User Cal Status** displays the summary results of the previous User Cal, and the status of probe calibrations for probes that can be calibrated. Note that passive

probes do not need to be calibrated, but InfiniiMax probes can be calibrated. For more information about calibrating probes see [page 39](#).

Results:

User Cal date:

Change in temperature since last User Cal:

Failure:

Comments:

Probe Cal Status:

Self Test

Pressing **Utility**→**Service**→**Start Self Test** performs a series of internal procedures to verify that the oscilloscope is operating properly.

It is recommended you run Self Test:

- after experiencing abnormal operation.
- for additional information to better describe an oscilloscope failure.
- to verify proper operation after the oscilloscope has been repaired.

Successfully passing Self Test does not guarantee 100% of the oscilloscope's functionality. Self Test is designed to provide an 80% confidence level that the oscilloscope is operating properly.

About Oscilloscope

Pressing **Utility**→**Service**→**About Oscilloscope** displays information about your oscilloscope model number, serial number, software version, boot version, graphics version, and installed licenses.

Installed licenses:

This line in the About This Oscilloscope dialog contains information about the licenses that have been installed on the oscilloscope. For example, it can show:

- **232** – UART (Universal Asynchronous Receiver/Transmitter) and RS232 (Recommended Standard 232) trigger and decode. This license provides trigger and decode capability for many UART protocols including RS232.
- **AMS** – Automotive Serial Decode. This license provides serial decode of CAN and LIN buses.
- **LSS** – Low Speed Serial Decode. This license provides serial decode of I²C and SPI buses.
- **SEC** – Secure Environment mode. This feature prevents oscilloscope setup and trace information from being stored in the oscilloscope's internal memory.
- **None** – No license installed.

To restore the oscilloscope to its default configuration

- Press the **Save/Recall** key, then press the **Default Setup** softkey.

The default configuration returns the oscilloscope to its default settings. This places the oscilloscope in a known operating condition. The major default settings are:

Horizontal main mode, 100 $\mu\text{s}/\text{div}$ scale, 0 s delay (horizontal position), center time reference.

Vertical Channel 1 on, 5 V/div scale, DC coupling, 0 V position, 1 M Ω impedance, probe factor to 1.0 if an AutoProbe probe is not connected to the channel.

Trigger Edge trigger, Auto sweep mode, 0 V level, channel 1 source, DC coupling, rising edge slope, 60 ns holdoff time.

Display Vectors on, 33% grid intensity, infinite persistence off.

Other Acquire mode normal, Run/Stop to Run, cursors and measurements off.

Labels All custom labels that you have created in the Label Library are preserved (not erased), but all channel labels will be set to their original names.



3 Triggering the Oscilloscope

Selecting Trigger Modes and Conditions	91
The External Trigger input	97
Trigger Types	100
To use Edge triggering	101
To use Pulse Width triggering	103
To use Pattern triggering	106
To use CAN triggering	108
To use I2C triggering	112
To use LIN triggering	118
To use SPI triggering	121
To use Duration triggering	127
To use TV triggering	130
To use UART/RS232 triggering	142
The Trigger Out connector	147



The Agilent InfiniiVision 5000 Series oscilloscopes provide a full set of features to help automate your measurement tasks. MegaZoom technology lets you capture and examine untriggered waveforms. With these oscilloscopes you can:

- Modify the way the oscilloscope acquires data.
- Set up simple or complex trigger conditions as needed, to capture only the sequence of events you want to examine.

Triggering Features

- Trigger modes:
 - Auto
 - Normal
 - Coupling (DC, AC, low frequency rejection)
 - Noise rejection
 - High frequency rejection
- Holdoff
- Trigger Level
- External Trigger input
- Trigger types:
 - Edge (slope)
 - Pulse width (glitch)
 - Pattern
 - Duration
 - TV
- Trigger Out connector

Selecting Trigger Modes and Conditions

The trigger mode affects the way in which the oscilloscope searches for the trigger. The figure below shows the conceptual representation of acquisition memory. Think of the trigger event as dividing acquisition memory into a pre-trigger and post-trigger buffer. The position of the trigger event in acquisition memory is defined by the time reference point and the horizontal position setting.

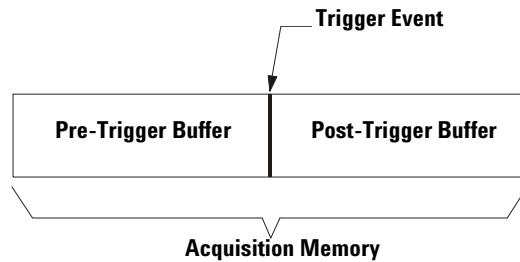
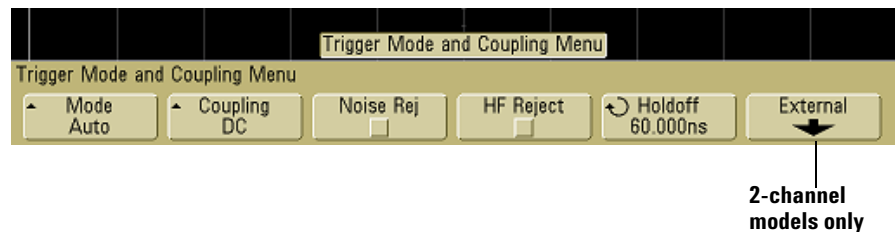

Figure 7 Acquisition Memory

To select the Mode and Coupling menu

- Press the **Mode/Coupling** key in the Trigger section of the front panel.



Trigger modes: Normal and Auto

An introduction to Normal and Auto trigger modes is given on [page 56](#).

- 1 Press the **Mode/Coupling** key.
- 2 Press the **Mode** softkey, then select **Normal** or **Auto**.
 - **Normal** mode displays a waveform when the trigger conditions are met, otherwise the oscilloscope does not trigger and the display is not updated.
 - **Auto** mode is the same as Normal mode, except it forces the oscilloscope to trigger if the trigger conditions are not met.

Auto mode

Use the auto trigger modes for signals other than low-repetitive-rate signals and for unknown signal levels. To display a DC signal, you must use auto trigger mode since there are no edges on which to trigger.

When you select **Run**, the oscilloscope operates by first filling the pre-trigger buffer. It starts searching for a trigger after the pre-trigger buffer is filled, and continues to flow data through this buffer while it searches for the trigger. While searching for the trigger, the oscilloscope overflows the pre-trigger buffer; the first data put into the buffer is the first pushed out (FIFO). When a trigger is found, the pre-trigger buffer will contain the events that occurred just before the trigger. If no trigger is found, the oscilloscope generates a trigger and displays the data as though a trigger had occurred. In this case, the background of the **Auto** indicator at the top of the display will flash, and the **Auto** indicator will change to **Auto?** indicating that the oscilloscope is forcing triggers.

When you press the **Single** key, the oscilloscope will fill pre-trigger buffer memory, and continue flowing data through the pre-trigger buffer until the auto trigger overrides the searching and forces a trigger. At the end of the trace, the oscilloscope will stop and display the results.

Normal mode

Use Normal trigger mode for low repetitive-rate signals or when Auto trigger is not required.

In Normal mode the oscilloscope must fill the pre-trigger buffer with data before it will begin searching for a trigger event. The trigger mode indicator on the status line flashes **Trig'd?** to indicate the oscilloscope is filling the pre-trigger buffer. While searching for the trigger, the oscilloscope overflows the pre-trigger buffer; the first data put into the buffer is the first pushed out (FIFO).

When the trigger event is found, the oscilloscope will fill the post-trigger buffer and display the acquisition memory. The trigger mode indicator on the status line indicates **Trig'd** (not flashing). If the acquisition was initiated by **Run/Stop**, the process repeats. If the acquisition was initiated by pressing **Single**, then the acquisition stops and you can Pan and Zoom the waveform.

In either Auto or Normal mode, the trigger may be missed completely under certain conditions. This is because the oscilloscope will not recognize a trigger event until the pre-trigger buffer is full. Suppose you set the Time/Div knob to a slow sweep speed, such as 500 ms/div. If the trigger condition occurs before the oscilloscope has filled the pre-trigger buffer, the trigger will not be found. If you use Normal mode and wait for the trigger condition indicator to flash before causing the action in the circuit, the oscilloscope will always find the trigger condition.

Some measurements you want to make will require you to take some action in the circuit under test to cause the trigger event. Usually, these are single-shot acquisitions, where you will use the **Single** key.

To select trigger Coupling

- 1 Press the **Mode/Coupling** key.
- 2 Press the **Coupling** softkey, then select **DC**, **AC**, or **LF Reject** coupling.
 - **DC** coupling allows DC and AC signals into the trigger path.
 - **AC** coupling places a 10 Hz high-pass filter in the trigger path removing any DC offset voltage from the trigger waveform. The high-pass filter in the External Trigger input path is 3.5 Hz for all models. Use AC coupling to get a stable edge trigger when your waveform has a large DC offset.
 - **LF (low frequency) Reject** coupling places a 50 kHz high-pass filter in series with the trigger waveform. Low frequency reject removes any unwanted low frequency components from a trigger waveform, such as power line frequencies, that can interfere with proper triggering. Use this coupling to get a stable edge trigger when your waveform has low frequency noise.
 - **TV** coupling is normally grayed-out, but is automatically selected when TV trigger is enabled in the Trigger More menu.

Note that Trigger Coupling is independent of Channel Coupling. To change Channel Coupling see [page 62](#).

To select trigger Noise Rejection and HF rejection

- 1 Press the **Mode/Coupling** key.
- 2 Press the **Noise Rej** softkey to select noise reject or press the **HF Reject** softkey to select high frequency reject.
 - **Noise Rej** adds additional hysteresis to the trigger circuitry. When noise reject is on, the trigger circuitry is less sensitive to noise but may require a greater amplitude waveform to trigger the oscilloscope.

- **HF Reject** adds a 50 kHz low-pass filter in the trigger path to remove high frequency components from the trigger waveform. You can use HF Reject to remove high-frequency noise, such as AM or FM broadcast stations or noise from fast system clocks, from the trigger path.

To set Holdoff

- 1 Press the **Mode/Coupling** key.
- 2 Turn the Entry knob  to increase or decrease the trigger holdoff time shown in the **Holdoff** softkey.

Holdoff sets the amount of time that the oscilloscope waits before re-arming the trigger circuitry. Use Holdoff to stabilize the display of complex waveforms.

To get a stable trigger on the pulse burst shown below, set the holdoff time to be >200 ns but <600 ns.

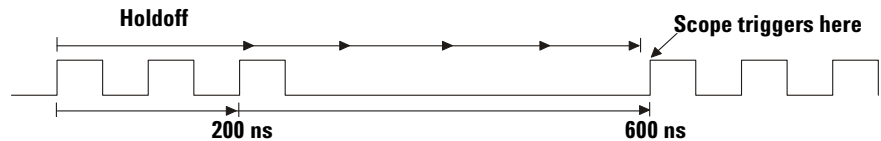

By setting the Holdoff, you can synchronize triggers. The oscilloscope will trigger on one edge of the waveform, and ignore further edges until the holdoff time expires. The oscilloscope will then re-arm the trigger circuit to search for the next edge trigger. This allows the oscilloscope to trigger on a repeating pattern in a waveform.

Holdoff Operating Hints

Holdoff keeps a trigger from occurring until after a certain amount of time has passed since the last trigger. This feature is valuable when a waveform crosses the trigger level multiple times during one period of the waveform.

Without holdoff, the oscilloscope could trigger on each of the crossings, producing a confusing waveform. With holdoff set correctly, the oscilloscope always triggers on the same crossing. The correct holdoff setting is typically slightly less than one period. Set the holdoff to this time to generate a unique trigger point. This action works even though many waveform periods pass between triggers, because the holdoff circuit operates on the input signal continuously.

Changing the time base settings does not affect the holdoff number. In contrast, the holdoff in analog oscilloscopes is a function of the time base setting, making it necessary to readjust the holdoff each time you change the time base setting.

With Agilent's MegaZoom technology, you can press **Stop**, then pan and zoom through the data to find where it repeats. Measure this time using the cursors, then set the holdoff.

The External Trigger input

The External Trigger input can be used as a source in several of the trigger types.

On 2-channel oscilloscopes, the external trigger BNC input is on the front panel and is labeled **Ext Trigger**.

On 4-channel oscilloscopes, the external trigger BNC input is on the rear panel and is labeled **Ext Trig**.

2-Channel oscilloscope External Trigger input

External Trigger Probe Settings

You can set external trigger probe parameters as described below.

- 1 Press the **Mode/Coupling** key in the Trigger section of the front panel.

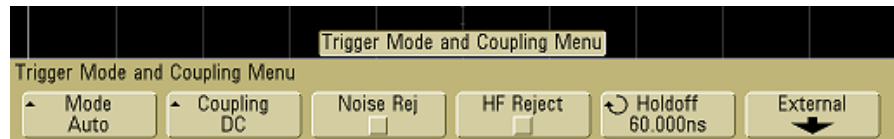

- 2 Press the **External** softkey to display the external trigger probe menu.

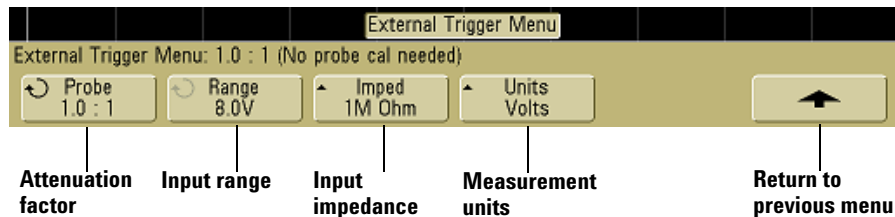

Probe Attenuation Turn the Entry knob to set the attenuation factor displayed in the **Probe** softkey for the connected probe. The attenuation factor can be set from 0.1:1 to 1000:1 in a 1-2-5 sequence.

3 Triggering the Oscilloscope

When you connect an AutoProbe self-sensing probe, the oscilloscope will automatically configure your probe to the correct attenuation factor.

The probe correction factor must be set properly for measurements to be made correctly.

Range The input voltage range can be set to 1.0 Volts or 8.0 Volts. When in current mode, the range is fixed at 1.0 Amps. Range is automatically scaled according to the probe's attenuation factor.

Maximum input voltage for the external trigger input of the 2-channel oscilloscope:

CAUTION



Maximum input voltage for external trigger (2-channel oscilloscopes)

CAT I 300 Vrms, 400 Vpk; transient overvoltage 1.6 kVpk

CAT II 100 Vrms, 400 Vpk

with N2863A 10:1 probe: CAT I 600 V, CAT II 300 V (DC + peak AC)

with 10073C 10:1 probe: CAT I 500 Vpk, CAT II 400 Vpk

CAUTION



Do not exceed 5 Vrms in 50 Ω mode. Input protection is enabled in 50 Ω mode and the 50 Ω load will disconnect if greater than 5 Vrms is detected. However the input could still be damaged, depending on the time constant of the signal. The 50 Ω input protection mode only functions when the oscilloscope is powered on.

Input Impedance The external trigger input impedance can be set to either **1M Ohm** or **50 Ohm** by pressing the **Imped** softkey.

- **50 Ohm** mode matches 50-ohm cables commonly used in making high frequency measurements. This impedance matching gives you the most accurate measurements since reflections are minimized along the signal path.
- **1M Ohm** mode is for use with many passive probes and for general-purpose measurements. The higher impedance minimizes the loading effect of the oscilloscope on the circuit under test.

Probe Units Press the **Units** softkey to select the proper measurement unit for the connected probe. Select **Volts** for a voltage probe and select **Amps** for a current probe. Measurement results, channel sensitivity, and trigger level will reflect the measurement units you have selected.

4-Channel oscilloscope External Trigger input

Input Impedance The external trigger input impedance for the 4-channel oscilloscope is approximately 1.015 k Ω .

Input Voltage The input voltage sensitivity is 500 mV, from DC to 100 MHz. The input voltage range is ± 15 V.

CAUTION



Maximum input voltage for external trigger (4-channel oscilloscopes)

Do not exceed 15 Vrms at rear panel External Trigger input or damage to the oscilloscope may occur.

There are no range or units settings for the External Trigger input of the 4-channel oscilloscope.

Trigger Types

The oscilloscope lets you synchronize the display to the actions of the circuit under test by defining a trigger condition. You can use any input channel or the Ext Trigger BNC as the source for most trigger types.

MegaZoom Technology Simplifies Triggering

With the built-in MegaZoom technology, you can simply AutoScale the waveforms, then stop the oscilloscope to capture a waveform. You can then pan and zoom through the data using the Horizontal and Vertical knobs to find a stable trigger point. AutoScale often produces a triggered display.

These trigger types are available and are presented in the following order in this chapter:

- Edge trigger
- Pulse Width (glitch) trigger
- Pattern trigger
- Duration trigger
- TV trigger

Changes to the trigger specification are applied when you make them. If the oscilloscope is stopped when you change a trigger specification, the oscilloscope will use the new specification when you press **Run/Stop** or **Single**. If the oscilloscope is running when you change a triggering specification, it uses the new trigger definition when it starts the next acquisition.

To use Edge triggering

The Edge trigger type identifies a trigger by looking for a specified edge (slope) and voltage level on a waveform. You can define the trigger source and slope in this menu. The slope can be set to rising edge, falling edge, or alternating edges on all sources except Line. The trigger type, source, and level are displayed in the upper-right corner of the display.

- 1 Press the **Edge** key in the Trigger section of the front panel to display the Edge trigger menu.

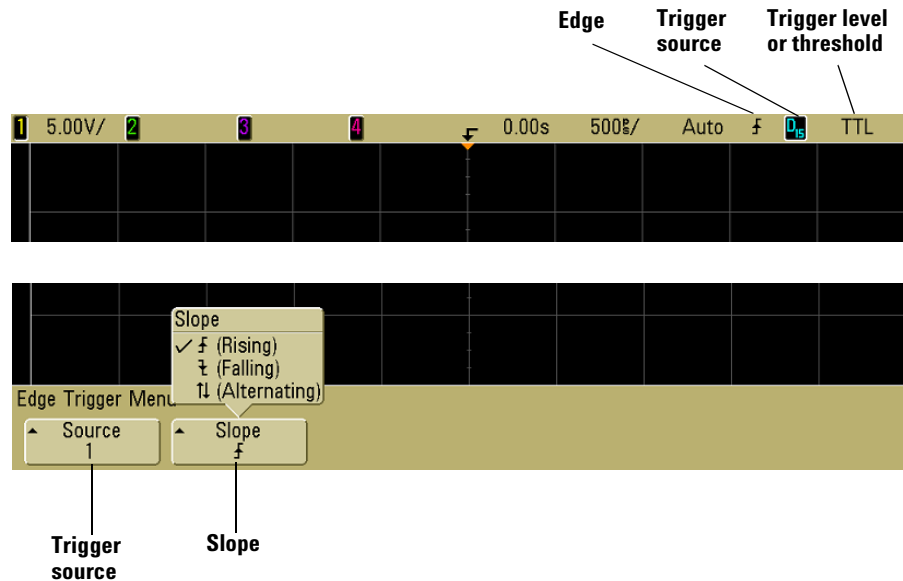

- 2 Press the **Slope** softkey and select rising edge, falling edge, or alternating edges. The selected slope is displayed in the upper-right corner of the display.

NOTE

Alternating edge mode is useful when you want to trigger on both edges of a clock (for example, DDR signals). All modes operate up to the bandwidth of the oscilloscope.

- 3 Select the trigger source.

You can select oscilloscope channel 1 or 2, Ext, or Line as the trigger source on any Agilent InfiniiVision 5000 Series oscilloscope. The trigger source can also be set to channel 3 and 4 on 4-channel oscilloscopes. You can choose a channel that is turned off (not displayed) as the source for the edge trigger.

The selected trigger source is indicated in the upper-right corner of the display next to the slope symbol:

1 through **4** = oscilloscope channels

E = External trigger

L = Line trigger

Trigger level adjustment

You can adjust the trigger level for a selected oscilloscope channel by turning the Trigger Level knob. The position of the trigger level for the channel is indicated by the trigger level icon  (if the channel is on) at the far left side of the display when DC coupling is selected. The value of the oscilloscope channel trigger level is displayed in the upper-right corner of the display.

When **Ext** (External Trigger) is selected, its level can be adjusted using the **Level** knob in the Trigger section of the front panel. The trigger level is displayed in the upper right corner of the display.

The line trigger level is not adjustable. This trigger is synchronized with the power line supplied to the oscilloscope.

To use Pulse Width triggering

Pulse Width (glitch) triggering sets the oscilloscope to trigger on a positive or negative pulse of a specified width. If you want to trigger on a specific timeout value, use **Duration** trigger in the Trigger **More** menu.

- 1 Press the **Pulse Width** key in the Trigger section of the front panel to display the Pulse Width trigger menu.

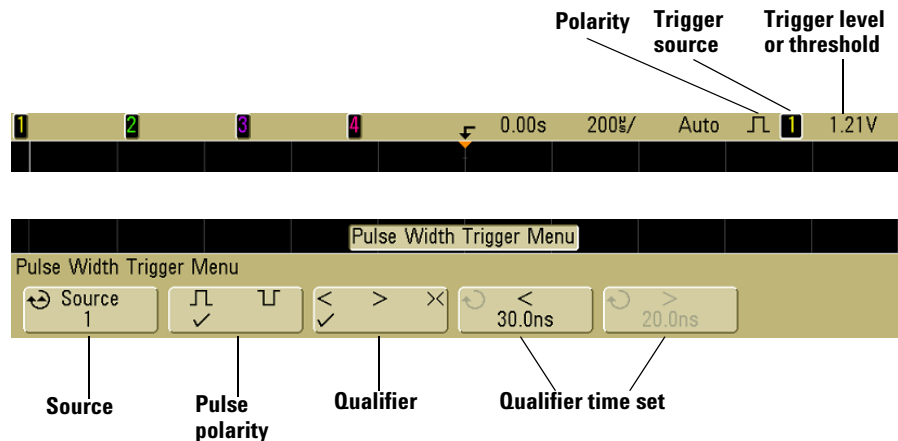

- 2 Press the **Source** softkey (or rotate the Entry knob on mixed-signal oscilloscopes) to select a channel source for the trigger.

The channel you select is shown in the upper-right corner of the display next to the polarity symbol.

The source can be any channel available on your oscilloscope. External trigger may also be specified as a source when using a 2-channel oscilloscope.

Adjust the trigger level for the selected channel by turning the Trigger Level knob. The value of the trigger level is displayed in the upper-right corner of the display.

- 3 Press the pulse polarity softkey to select positive (⏏) or negative (⏏) polarity for the pulse width you want to capture.

3 Triggering the Oscilloscope

The selected pulse polarity is displayed in the upper-right corner of the display. A positive pulse is higher than the current trigger level or threshold and a negative pulse is lower than the current trigger level or threshold.

When triggering on a positive pulse, the trigger will occur on the high to low transition of the pulse if the qualifying condition is true. When triggering on a negative pulse, the trigger will occur on the low to high transition of the pulse if the qualifying condition is true.

- 4 Press the qualifier softkey (< > ><) to select the time qualifier.

The Qualifier softkey can set the oscilloscope to trigger on a pulse width that is:

- less than a time value (<).

For example, for a positive pulse, if you set $t < 10$ ns:



- greater than a time value (>).

For example, for a positive pulse, if you set $t > 10$ ns:



- within a range of time values (><).

For example, for a positive pulse, if you set $t > 10$ ns and $t < 15$ ns:

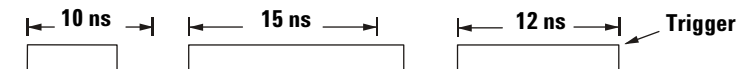

- 5 Select the qualifier time set softkey (< or >), then rotate the Entry knob to set the pulse width qualifier time.

The qualifiers can be set as follows:

- 2 ns to 10 s for > or < qualifier (5 ns to 10 s for 100 MHz and 300 MHz bandwidth models)
- 10 ns to 10 s for >< qualifier, with minimum difference of 5 ns between upper and lower settings

< qualifier time set softkey

- When the less than (<) qualifier is selected, the Entry knob sets the oscilloscope to trigger on a pulse width less than the time value displayed on the softkey.
- When the time range (><) qualifier is selected, the Entry knob sets the upper time range value.

> qualifier time set softkey

- When the greater than (>) qualifier is selected, the Entry knob sets the oscilloscope to trigger on a pulse width greater than the time value displayed on the softkey.
- When the time range (><) qualifier is selected, the Entry knob sets the lower time range value.

To use Pattern triggering

The Pattern trigger identifies a trigger condition by looking for a specified pattern. This pattern is a logical AND combination of the channels. Each channel can have a value of high (1), low (0), or don't care (X). A rising or falling edge can be specified for one channel included in the pattern.

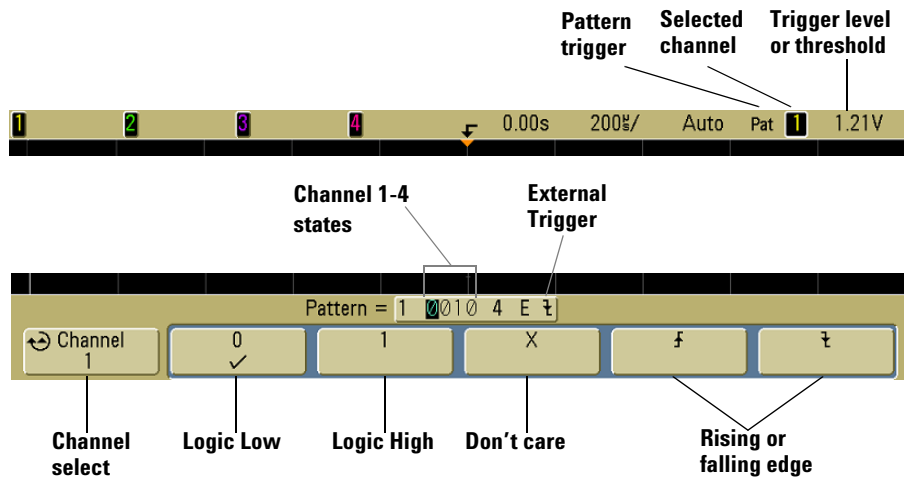

- 1 Press the **Pattern** key in the Trigger section of the front panel to display the Pattern trigger menu.



- 2 For each oscilloscope channel you want to include in the desired pattern, press the **Channel** softkey to select the channel.

This is the channel source for the 0, 1, X, or edge condition. As you press the **Channel** softkey (or rotate the Entry knob on mixed-signal oscilloscopes), the channel you select is highlighted in the **Pattern =** line directly above the softkeys and in the upper-right corner of the display next to “**Pat**”. External trigger may also be specified as a channel in the pattern when using the 2-channel and 4-channel oscilloscopes.

Adjust the trigger level for the selected channel by turning the Trigger Level knob. The value of the trigger level is displayed in the upper-right corner of the display.

- 3** For each channel you select, press one of the condition softkeys to set the condition for that channel in the pattern.
- **0** sets the pattern to low on the selected channel. A low is a voltage level that is less than the channel's trigger level or threshold level.
 - **1** sets the pattern to high on the selected channel. A high is a voltage level that is greater than the channel's trigger level or threshold level.
 - **X** sets the pattern to don't care on the selected channel. Any channel set to don't care is ignored and is not used as part of the pattern. However, if all channels in the pattern are set to don't care, the oscilloscope will not trigger.
 - The rising edge () or falling edge () softkey sets the pattern to an edge on the selected channel. Only one rising or falling edge can be specified in the pattern. When an edge is specified, the oscilloscope will trigger at the edge specified if the pattern set for the other channels is true.

If no edge is specified, the oscilloscope will trigger on the last edge that makes the pattern true.

Specifying an Edge in a Pattern

You are allowed to specify only one rising or falling edge term in the pattern. If you define an edge term, then select a different channel in the pattern and define another edge term, the previous edge definition is changed to a don't care.

To use CAN triggering

NOTE

For CAN decode setup see [page 226](#).

Controller Area Network (CAN) trigger will trigger on CAN version 2.0A and 2.0B signals. Setup consists of connecting the oscilloscope to a CAN signal, using the **Settings** menu to specify the event to trigger on, and using the **Signals** menu to specify the signal source, baud rate, and sample point.

The oscilloscope will trigger on dominant-low CAN signals. If you are connecting to the CAN signal using a differential probe, connect the probe’s positive lead to the dominant-low CAN signal (CAN_L) and connect the negative lead to the dominant-high CAN signal (CAN_H).

The CAN trigger will trigger on the Start of Frame (SOF) bit of a data frame. If the N5424A CAN/LIN Automotive Triggering and Decode option is installed on your oscilloscope, the following additional CAN trigger types will also be available: Remote Frame ID (RTR), Data Frame ID (~RTR), Remote or Data Frame ID, Data Frame ID and Data, Error Frame, All Errors, Acknowledge Error, and Overload Frame.

A CAN message frame in CAN_L signal type is shown below:

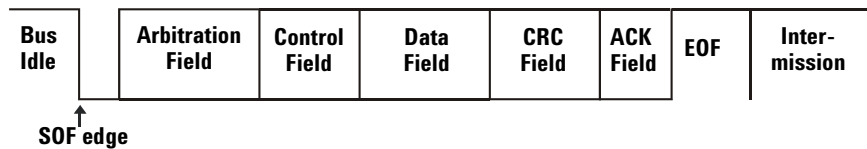

- 1 Press the **More** key in the Trigger section of the front panel, rotate the Entry knob until **CAN** is displayed in the **Trigger**

softkey, then press the **Settings** softkey to display CAN trigger menu.

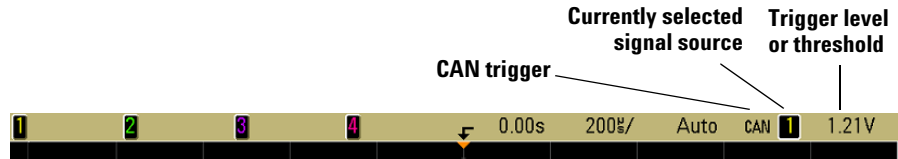

2 Repeatedly press and release the **Trigger:** softkey or rotate the Entry knob to select the trigger condition.

- **SOF - Start of Frame** – The oscilloscope triggers at the start of a frame.
- **Remote Frame ID (RTR)** – The oscilloscope triggers on remote frames with the specified ID. Press the **Bits** softkey to select the ID. For details about using the Bits softkeys, press and hold the softkey in question to display the built-in help for this subject.
- **Data Frame ID (~RTR)** - The oscilloscope will trigger on data frames matching the specified ID. Press the **Bits** softkey to select the ID.
- **Remote or Data Frame ID** - The oscilloscope will trigger on remote or data frames matching the specified ID. Press the **Bits** softkey to select the ID.
- **Data Frame ID and Data** - The oscilloscope will trigger on data frames matching the specified ID and data. Press the **Bits** softkey to select the ID and set up the number of data bytes and values.

3 Triggering the Oscilloscope

- **Error Frame** - The oscilloscope will trigger on CAN active error frames.
 - **All Errors** - The oscilloscope will trigger when any form error or active error is encountered.
 - **Acknowledge Error** - The oscilloscope will trigger when the acknowledge bit is recessive (high).
 - **Overload Frame** - The oscilloscope will trigger on CAN overload frames.
- 3 If necessary, press the up-arrow softkey to return to the CAN Trigger menu. Press the **Signals** softkey to enter the CAN Signals menu.

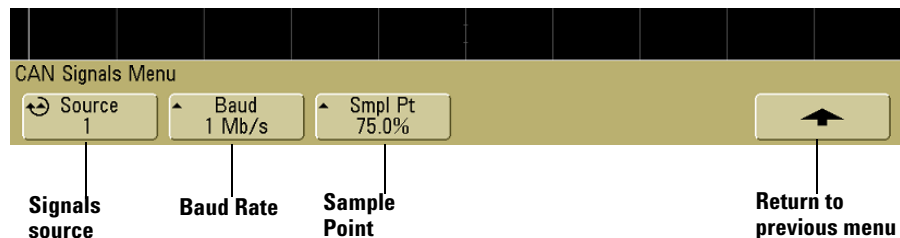
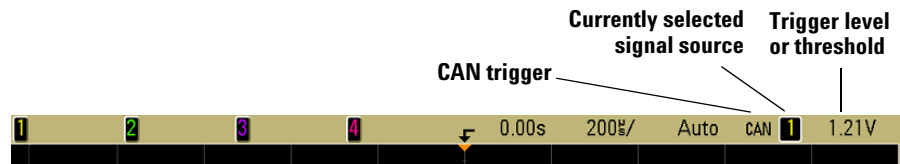

- 4 Press the **Source** softkey to select the channel connected to the CAN signal line.

As you repeatedly press the **Source** softkey (or rotate the Entry knob), the **CAN** label for the source channel is automatically set and the channel you select is shown in the upper-right corner of the display next to "CAN".

Adjust the trigger level for the selected analog channel by turning the Trigger Level knob. Press the **D15-D0** key and select **Thresholds** to set the threshold level for digital channels. The value of the trigger level or digital threshold is displayed in the upper-right corner of the display.

- 5 Repeatedly press and release the **Baud** softkey to set the CAN signal baud rate to match your CAN bus signal.

The CAN baud rate can be set to:

10 kb/s	50 kb/s	100 kb/s	500 kb/s
20 kb/s	62.5 kb/s	125 kb/s	800 kb/s
33.3 kb/s	83.3 kb/s	250 kb/s	1 Mb/s

The default baud rate is 1 Mb/s

- 6 Repeatedly press and release the **Smpl Pt** softkey to select the point between phase segments 1 and 2 where the state of the bus is measured. This controls the point within the bit's time where the bit value is captured.

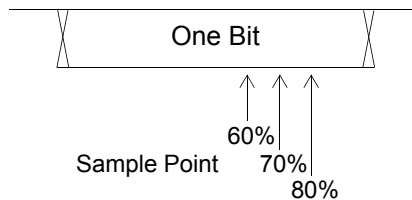

You can use the horizontal sweep **Zoom** mode for easier navigation of the decoded data.

NOTE

If the setup does not produce a stable trigger, the CAN signal may be slow enough that the oscilloscope is AutoTriggering. Press the **Mode/Coupling** key, then press the **Mode** softkey to set the trigger mode from **Auto** to **Normal**.

To use I²C triggering

NOTE

For I²C decode setup see [page 217](#).

An I²C (Inter-IC bus) trigger setup consists of connecting the oscilloscope to the serial data (SDA) line and the serial clock (SCL) line, then triggering on a stop/start condition, a restart, a missing acknowledge, an EEPROM data read, or on a read/write frame with a specific device address and data value.

- 1 Press the **More** key in the Trigger section of the front panel, rotate the Entry knob until **I²C** is displayed in the **Trigger** softkey, then press the **Settings** softkey to display the I²C trigger menu.

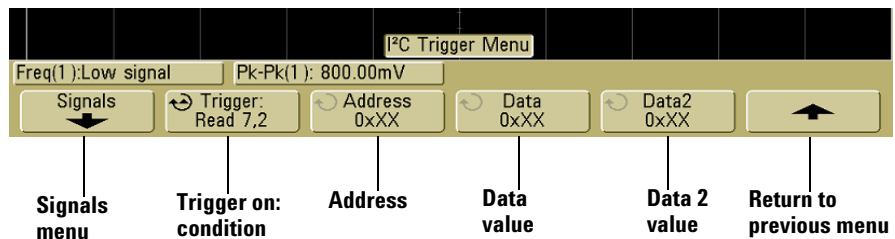
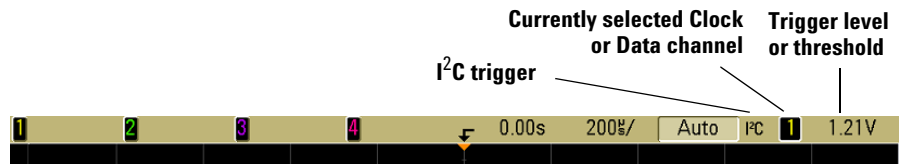

- 2 Press the **Signals** softkey to display the I²C signals menu.

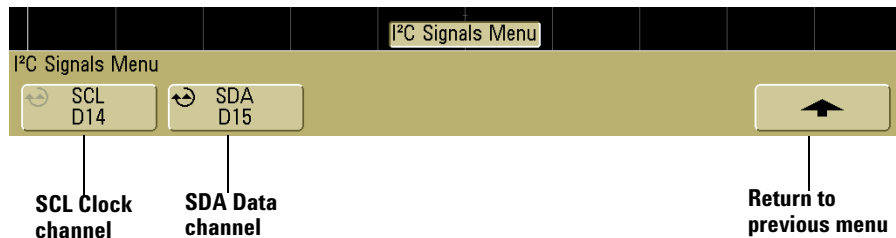

- 3 Connect an oscilloscope channel to the SCL (serial clock) line in the circuit under test, then set the **SCL** clock channel softkey to that channel.

As you press the **SCL** softkey (or rotate the Entry knob on mixed-signal oscilloscopes), the **SCL** label for the source channel is automatically set and the channel you select is shown in the upper-right corner of the display next to “I²C”.

Adjust the trigger level for the selected analog channel by turning the Trigger Level knob. Press the **D15-D0** key and select **Thresholds** to set the threshold level for digital channels. The value of the trigger level or digital threshold is displayed in the upper-right corner of the display.

- 4 Choose 7-bit or 8-bit address size. Use 8-bit address size to include the R/W bit as part of the address value, or choose 7-bit address size to exclude the R/W bit from the address value.
- 5 Connect an oscilloscope channel to the SDA (serial data) line in the circuit under test, then set the **SDA** data channel softkey to that channel.

As you press the **SDA** softkey (or rotate the Entry knob on mixed-signal oscilloscopes), the **SDA** label for the source channel is automatically set and the channel you select is shown in the upper-right corner of the display next to “I²C”.

Adjust the trigger level for the selected analog channel by turning the Trigger Level knob. Press the **D15-D0** key and select **Thresholds** to set the threshold level for digital channels. The value of the trigger level or digital threshold is displayed in the upper-right corner of the display.

3 Triggering the Oscilloscope

Data needs to be stable during the whole high clock cycle or it will be interpreted as a start or stop condition (data transitioning while the clock is high).

6 Return to the previous menu; then, press the **Trigger:** softkey to select one of the following I²C trigger conditions:

- **Start Condition** – The oscilloscope triggers when SDA data transitions from high to low while the SCL clock is high. For triggering purposes (including frame triggers), a restart is treated as a start condition.
- **Stop Condition** – The oscilloscope triggers when data (SDA) transitions from low to high while the clock (SCL) is high.

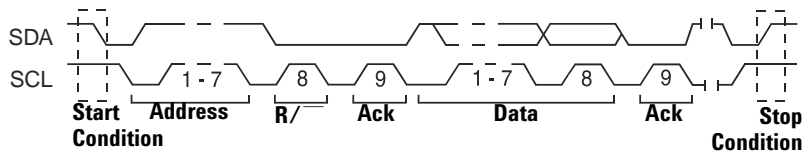

- **Missing Acknowledge** – The oscilloscope triggers when SDA data is high during any Ack SCL clock bit.
- **Address with no Ack** – The oscilloscope triggers when the acknowledge of the selected address field is false. The R/W bit is ignored.
- **Restart** – The oscilloscope triggers when another start condition occurs before a stop condition.

- **EEPROM Data Read** – The trigger looks for EEPROM control byte value 1010xxx on the SDA line, followed by a Read bit and an Ack bit. It then looks for the data value and qualifier set by the **Data** softkey and the **Data is** softkey. When this event occurs, the oscilloscope will trigger on the clock edge for the Ack bit after the data byte. This data byte does not need to occur directly after the control byte.

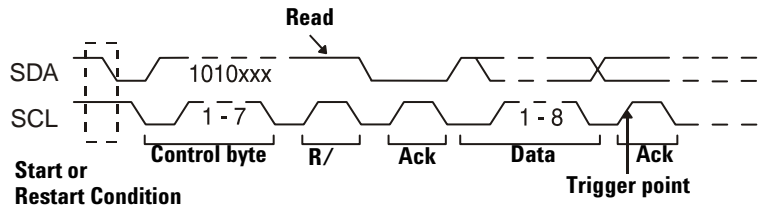

- **Frame (Start: Addr7: Read: Ack: Data) or Frame (Start: Addr7: Write: Ack: Data)** – The oscilloscope triggers on a read or write frame in 7-bit addressing mode on the 17th clock edge if all bits in the pattern match. For triggering purposes, a restart is treated as a start condition.

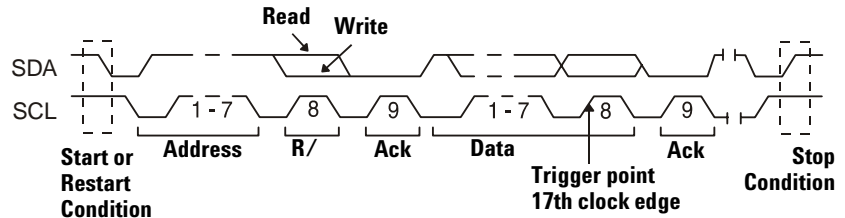

3 Triggering the Oscilloscope

- **Frame (Start: Addr7: Read: Ack: Data: Ack: Data2)** or **Frame (Start: Addr7: Write: Ack: Data: Ack: Data2)** – The oscilloscope triggers on a read or write frame in 7-bit addressing mode on the 26th clock edge if all bits in the pattern match. For triggering purposes, a restart is treated as a start condition.

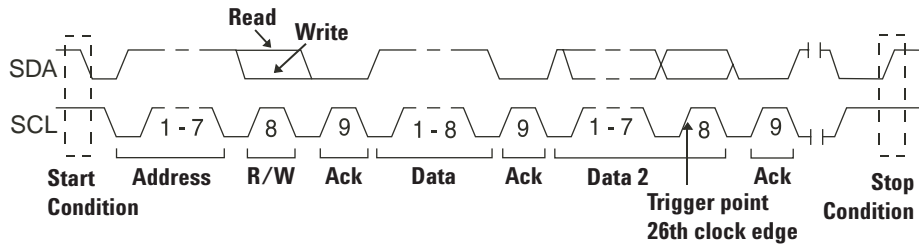

- **10-bit Write** – The oscilloscope triggers on a 10-bit write frame on the 26th clock edge if all bits in the pattern match. The frame is in the format:

Frame (Start: Address byte 1: Write: Address byte 2: Ack: Data)

For triggering purposes, a restart is treated as a start condition.

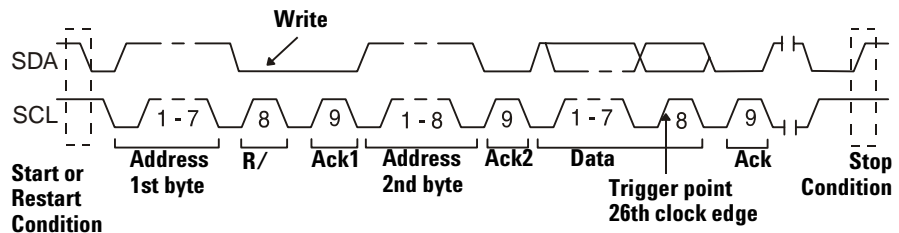

- 7** If you have set the oscilloscope to trigger on an EEPROM Data Read condition:

Press the **Data is** softkey to set the oscilloscope to trigger when data is = (equal to), \neq (not equal to), < (less than), or > (greater than) the data value set in the **Data** softkey.

The oscilloscope will trigger on the clock edge for the Ack bit after the trigger event is found. This data byte does not need to occur directly after the control byte. The oscilloscope will trigger on any data byte that meets the criteria defined by the **Data is** and **Data** softkeys during a current address read or a random read or a sequential read cycle.

- 8 If you have set the oscilloscope to trigger on a 7-bit address read or write frame condition or a 10-bit write frame condition:
 - a Press the **Address** softkey and turn the Entry knob to select the 7-bit or 10-bit device address.

You can select from an address range of 0x00 to 0x7F (7-bit) or 0x3FF (10-bit) hexadecimal. When triggering on a read/write frame, the oscilloscope will trigger after the start, address, read/write, acknowledge, and data events occur.

If don't care is selected (0xXX or 0XXX) for the address, the address will be ignored. The trigger will always occur on the 17th clock for 7-bit addressing or 26th clock for 10-bit addressing.

- b Press the **Data** value softkey and turn the Entry knob to select the 8-bit data pattern on which to trigger.

You can select a data value in the range of 0x00 to 0xFF (hexadecimal). The oscilloscope will trigger after the start, address, read/write, acknowledge, and data events occur.

If don't care (0xXX) is selected for data, the data will be ignored. The trigger will always occur on the 17th clock for 7-bit addressing or 26th clock for 10-bit addressing.

- c If you have selected a three-byte trigger, press the **Data2** value softkey and turn the Entry knob to select the 8-bit data pattern on which to trigger.

To use LIN triggering

NOTE

For LIN decode information see [page 233](#).

LIN (Local Interconnect Network) trigger setup consists of connecting the oscilloscope to a serial LIN signal.

LIN triggering will trigger on the rising edge at the Sync Break exit of the LIN single-wire bus signal that marks the beginning of the message frame. If the N5424A CAN/LIN Automotive Triggering and Decode option is installed on your oscilloscope, the Frame ID trigger type will also be available.

A LIN signal message frame is shown below:

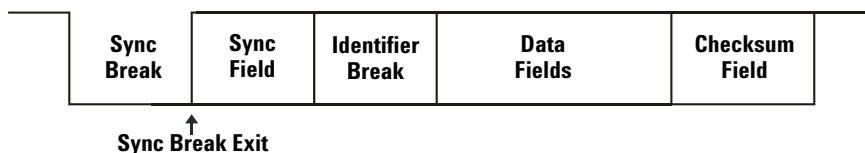

- 1 Press the **More** key in the Trigger section of the front panel, rotate the Entry knob until **LIN** is displayed in the **Trigger** softkey.
- 2 Press the **Settings** softkey to display LIN trigger menu.

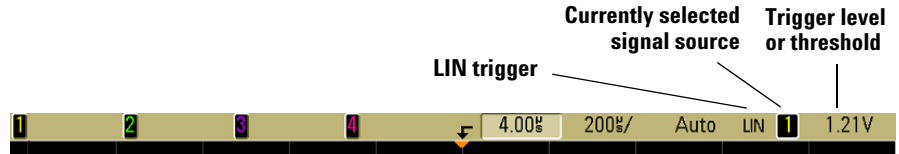

- 3 Press the **Trigger:** softkey and choose to trigger on Sync Break or Frame ID.

Sync (Sync Break) The oscilloscope will trigger on the rising edge at the Sync Break exit of the LIN single-wire bus signal that marks the beginning the message frame.

ID (Frame ID) The oscilloscope will trigger when a frame with an ID equal to the selected value is detected. Use the **Entry** knob to select the value for the Frame ID.

3 Triggering the Oscilloscope

- 4 Press the **Signals** softkey. The LIN Signals Menu will be displayed.

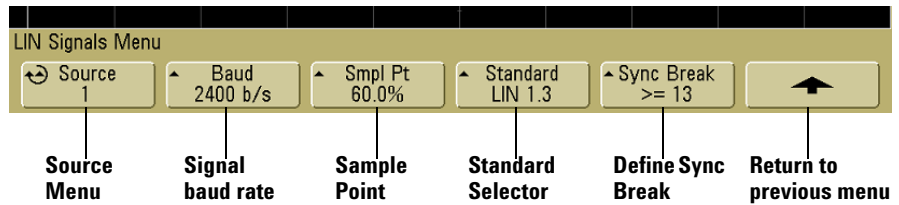

- 5 Press the **Source** softkey to select the channel connected to the LIN signal line.

Adjust the trigger level for the selected analog channel by turning the Trigger Level knob. Press the **D15-D0** key and select **Thresholds** to set the threshold level for digital channels. The value of the trigger level or digital threshold is displayed in the upper-right corner of the display.

- 6 Press the **Baud** softkey to set the LIN signal baud rate to match your LIN bus signal.

The LIN baud rate can be set to 2400 b/s, 9600 b/s, 10.4 kb/s, 19.2 kb/s, 115.2 kb/s, or 625 kb/s. The default baud rate is 2400 b/s.

- 7 Press the **Smpl Pt** softkey to select the sample point at which the oscilloscope will sample the bit value.

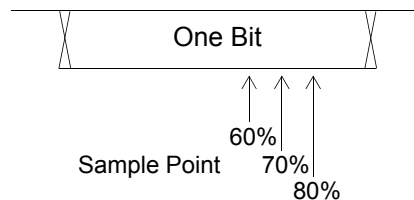

- 8 Press the **Standard** softkey to select the LIN standard you are measuring (LIN 1.3 or LIN 2.0).
- 9 Press the **Sync Break** softkey and select the minimum number of clocks that define a sync break in your LIN signal.

To use SPI triggering

NOTE

For SPI decode information see [page 221](#).

Serial Peripheral Interface (SPI) trigger setup consists of connecting the oscilloscope to a clock, data, and framing signal. You can then trigger on a data pattern that occurs at the start of a frame. The serial data string can be specified to be from 4 to 32 bits long.

When you press the **Settings** softkey, a graphic will be displayed showing the current state of the frame signal, clock slope, number of data bits, and data bit values. Press the **Signals** softkey in the **Settings** menu to see the current source channels for the clock, data, and frame signals.

- Press the **More** key in the Trigger section of the front panel, rotate the Entry knob until **SPI** is displayed in the **Trigger** softkey, then press the **Settings** softkey to display the SPI trigger menu.

3 Triggering the Oscilloscope

Currently selected Clock, Framing, or Data channel

Trigger level or threshold

SPI trigger

0.000s 200%/ Auto SPI 1.40V

Graphic showing current state of the SPI trigger setup

Data string values

~CS

CLK

DATA

Bit 0 Bit 1 Bit N-1 Bit N

Trigger Point

Data: XXXX XXXX

SPI Trigger Menu

Signals

#Bits 8

Bit 0

0 1 X

Set all Bits X

Assign channels

data bits in string

Data bit select

Data bit value

Set all data bits to value

Return to previous menu

Assign source channels to the clock, data, and frame signals

- 1 Press the **Signals** softkey to access SPI trigger settings for clock source and slope, data source, and frame type and source.

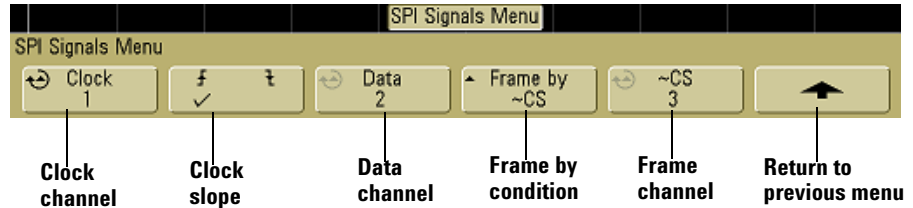

- 2 Press the **Clock** softkey or turn the Entry knob to select the channel connected to the SPI serial clock line.

As you press the **Clock** softkey (or rotate the Entry knob on mixed-signal oscilloscopes), the **CLK** label for the source channel is automatically set and the channel you select is shown in the upper-right corner of the display next to “**SPI**”.

Adjust the trigger level for the selected analog channel by turning the Trigger Level knob. Press the **D15-D0** key and select **Thresholds** to set the threshold level for digital channels. The value of the trigger level or digital threshold is displayed in the upper-right corner of the display.

- 3 Press the slope softkey (\uparrow \downarrow) to select rising edge or falling edge for the selected Clock source.

This determines which clock edge the oscilloscope will use to latch the serial data. When you press the slope softkey, the graphic shown on the display changes to show the current state of the clock signal.

3 Triggering the Oscilloscope

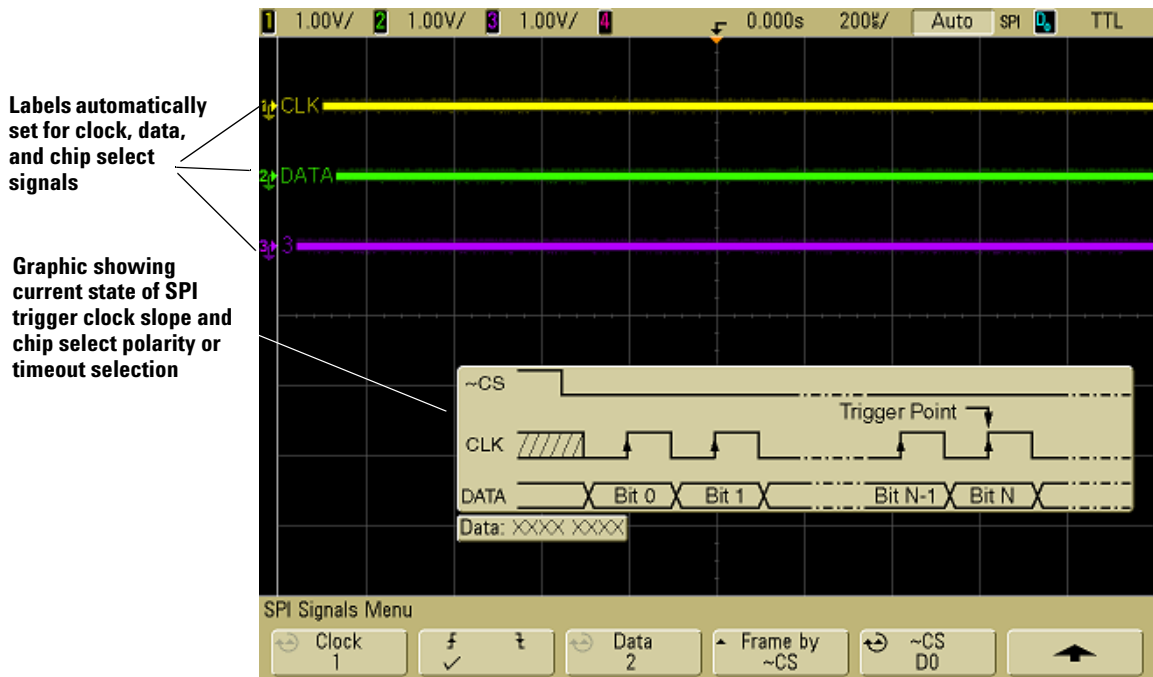

- 4 Press the **Data** softkey or turn the Entry knob to select the channel that is connected to the SPI serial data line. (If the channel you selected is off, switch it on.)

As you press the **Data** softkey (or rotate the Entry knob on mixed-signal oscilloscopes), the **DATA** label for the source channel is automatically set and the channel you select is shown in the upper-right corner of the display next to “**SPI**”.

Adjust the trigger level for the selected analog channel by turning the Trigger Level knob. Press the **D15-D0** key and select **Thresholds** to set the threshold level for digital channels. The value of the trigger level or digital threshold is displayed in the upper-right corner of the display.

- 5 Press the **Frame by** softkey to select a framing signal that the oscilloscope will use for determining which clock edge is the first clock edge in the serial stream.

You can set the oscilloscope to trigger during a high chip select (**CS**), a low chip select (**~CS**), or after a **Timeout** period during which the clock signal has been idle.

- If the framing signal is set to **CS** (or **~CS**), the first clock edge as defined, rising or falling, seen after the **CS** (or **~CS**) signal transitions from low to high (or high to low) is the first clock in the serial stream.

Chip Select – Press the **CS** or **~CS** softkey or turn the Entry knob to select the channel that is connected to the SPI frame line. The label (**~CS** or **CS**) for the source channel is automatically set. The data pattern and the clock transition must occur during the time when the framing signal is valid. The framing signal must be valid for the entire data pattern.

As you press the **CS** or **~CS** softkey (or rotate the Entry knob on mixed-signal oscilloscopes), the **CS** or **~CS** label for the source channel is automatically set and the channel you select is shown in the upper-right corner of the display next to “**SPI**”. When you press the **Frame by** softkey, the graphic shown on the previous page changes to show timeout selection or the current state of the chip select signal.

Adjust the trigger level for the selected analog channel by turning the Trigger Level knob. Press the **D15-D0** key and select **Thresholds** to set the threshold level for digital channels. The value of the trigger level or digital threshold is displayed in the upper-right corner of the display.

- If the framing signal is set to **Timeout**, the oscilloscope generates it’s own internal framing signal after it sees inactivity on the serial clock line.

Clock Timeout – Select **Clock Timeout** in the **Frame by** softkey, then select the **Timeout** softkey and turn the Entry knob to set the minimum time that the Clock signal must be idle (not transitioning) before the oscilloscope will search for the Data pattern on which to trigger. When you press the **Frame by** softkey, the graphic shown on the previous page changes to show timeout selection or the current state of the chip select signal.

The Timeout value can be set anywhere from 100 ns to 10 s.

- 6 Press the up-arrow softkey to return to the previous menu.

Set up the number of bits in the serial data string and set values for those data bits

- 1 Press the **#Bits** softkey, and turn the Entry knob to set the number of bits (**#Bits**) in the serial data string. The number of bits in the string can be set anywhere from 4 bits to 32 bits. The data values for the serial string are displayed in the Data string in the waveform area.
- 2 Turn the Entry knob to select a specific data bit in the serial string as shown in the **Bit** softkey.

As you rotate the Entry knob, the bit is highlighted in the Data string shown in the waveform area.

- 3 Press the **0 1 X** softkey to set the bit selected in the **Bit** softkey to **0** (low), **1** (high), or **X** (don't care).

Repeat steps 2 and 3 to assign values for all bits.

Resetting all bits in the serial data string to one value

- To reset all of the bit values in the serial data string to one value (0, 1, or X):
 - a Press the **0 1 X** softkey to select your reset bit value.
 - b Press the **Set all Bits** softkey to reset the data string to the selected value.

To use Duration triggering

Duration trigger lets you define a pattern, then trigger on a specified time duration of this logical AND combination of the channels.

- 1 Press the **More** key in the Trigger section of the front panel, rotate the Entry knob until **Duration** is displayed in the **Trigger** softkey, then press the **Settings** softkey to display the Duration trigger menu.

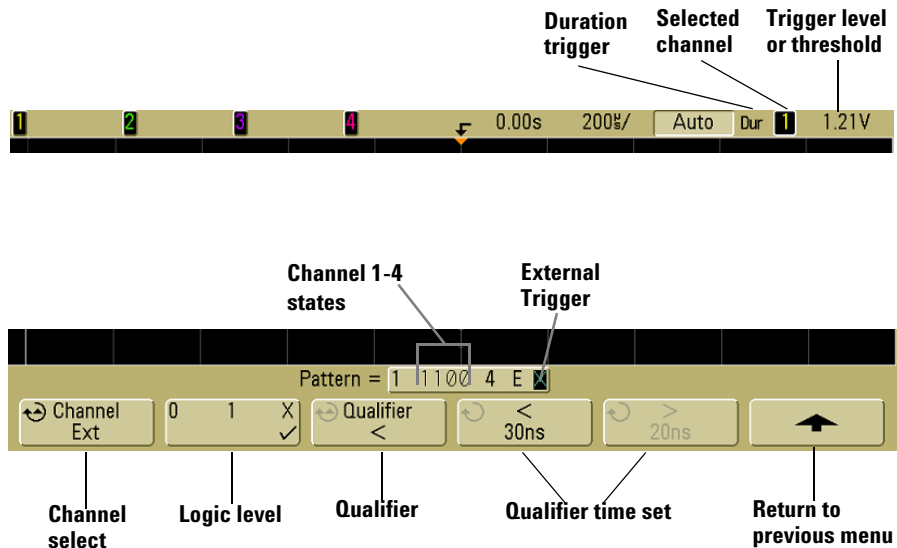

- 2 For each channel you want to include in the desired pattern, press the **Channel** softkey to select the channel.

This is the channel source for the 0, 1, or X condition. As you press the **Channel** softkey (or rotate the Entry knob on mixed-signal oscilloscopes), the channel you select is highlighted in the **Pattern =** line directly above the softkeys and in the upper-right corner of the display next to “**Dur**”. External trigger may also be specified as a channel in the pattern when using the 2-channel and 4-channel oscilloscopes.

Adjust the trigger level for the selected channel by turning the Trigger Level knob. The value of the trigger level is displayed in the upper-right corner of the display.

- 3 For each channel you select, press the logic level softkey to set the condition for that channel in the pattern.
 - **0** sets the pattern to low on the selected channel. A low is a voltage level that is less than the channel's trigger level or threshold level.
 - **1** sets the pattern to high on the selected channel. A high is a voltage level that is greater than the channel's trigger level or threshold level.
 - **X** sets the pattern to don't care on the selected channel. Any channel set to don't care is ignored and is not used as part of the pattern. If all channels in the pattern are set to don't care, the oscilloscope will not trigger.
- 4 Press the **Qualifier** softkey to set the time duration qualifier for the pattern.

The time qualifier can set the oscilloscope to trigger on a channel pattern whose time duration is:

- less than a time value (<)
- greater than a time value (>)
- greater than a time value, but with timeout (**Timeout**). A trigger will be forced at the timeout value, rather than occurring when the pattern is exited.
- within a range of time values (><)
- outside a range of time values (<>)

The time values for the selected qualifier are set using the qualifier time set softkeys (< and >) and the Entry knob.

- 5 Select a qualifier time set softkey (< or >), then rotate the Entry knob to set the duration qualifier time.

< qualifier time set softkey

- When the less than (<) qualifier is selected, the Entry knob sets the oscilloscope to trigger on a pattern duration less than the time value displayed on the softkey.

- When the within time range (><) qualifier is selected, the Entry knob sets the upper time range value.
- When the out of time range (<>) qualifier is selected, the Entry knob sets the lower time range value.

> qualifier time set softkey

- When the greater than (>) qualifier is selected, the Entry knob sets the oscilloscope to trigger on a pattern duration greater than the time value displayed on the softkey.
- When the within time range (><) qualifier is selected, the Entry knob sets the lower time range value.
- When the out of time range (<>) qualifier is selected, the Entry knob sets the upper time range value.
- When **Timeout** qualifier is selected, the Entry knob sets the timeout value.

When the duration trigger occurs

The timer starts on the last edge that makes the pattern (logical AND) true. The trigger will occur on the first edge that makes the pattern false if the time qualifier criteria of the pattern has been met, except in Timeout mode. In Timeout, the trigger occurs when the timeout value is reached while the pattern is true.

To use TV triggering

TV triggering can be used to capture the complicated waveforms of most standard and high-definition analog video signals. The trigger circuitry detects the vertical and horizontal interval of the waveform and produces triggers based on the TV trigger settings you have selected.

The oscilloscope's MegaZoom III technology gives you bright, easily viewed displays of any part of the video waveform. Analysis of video waveforms is simplified by the oscilloscope's ability to trigger on any selected line of the video signal.

- 1 Press the **More** key in the Trigger section of the front panel. If **TV** is not selected, rotate the Entry knob until **TV** is displayed in the **Trigger** softkey, then press the **Settings** softkey to display TV trigger menu.

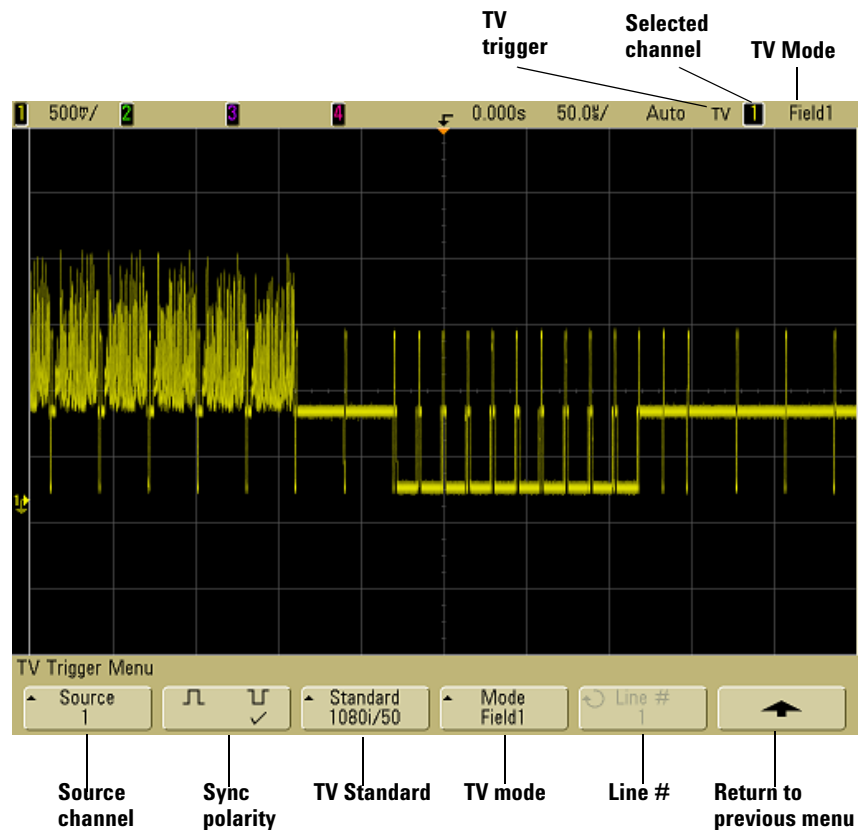

- 2 Press the **Source** softkey and select any oscilloscope channel as the TV trigger source.

The selected trigger source is displayed in the upper-right corner of the display. Turning the Trigger **Level** knob does not change the trigger level because the trigger level is automatically set to the sync pulse. Trigger coupling is automatically set to **TV** in the Trigger **Mode/Coupling** menu.

Provide Correct Matching

Many TV signals are produced from 75 Ω sources. To provide correct matching to these sources, a 75 Ω terminator (such as an Agilent 11094B) should be connected to the oscilloscope input.

- 3 Press the sync polarity softkey to set the TV trigger to either positive (⌋) or negative (⌋) sync polarity.
- 4 Press the **Standard** softkey to set the TV standard.

The oscilloscope supports triggering on the following television (TV) and video standards.

Standard	Type	Sync Pulse
NTSC	Interlaced	Bi-level
PAL	Interlaced	Bi-level
PAL-M	Interlaced	Bi-level
SECAM	Interlaced	Bi-level
Generic	Interlaced/Progressive	Bi-level/Tri-level
EDTV 480p/60	Progressive	Bi-level
HDTV 720p/60	Progressive	Tri-level
HDTV 1080p/24	Progressive	Tri-level
HDTV 1080p/25	Progressive	Tri-level
HDTV 1080i/50	Interlaced	Tri-level
HDTV 1080i/60	Interlaced	Tri-level

- 5 Press the **Mode** softkey to select the portion of the video signal that you would like to trigger on.

The TV trigger modes available are:

- **Field1** and **Field2** – Trigger on the rising edge of the first serration pulse of field 1 or field 2 (interlaced standards only).
- **All Fields** – Trigger on the rising edge of the first pulse in the vertical sync interval (not available in Generic mode).
- **All Lines** – Trigger on all horizontal sync pulses.
- **Line** – Trigger on the selected line # (EDTV and HDTV standards only).
- **Line: Field1** and **Line:Field2** – Trigger on the selected line # in field 1 or field 2 (interlaced standards only except 1080i).
- **Line: Alternate** – Alternately trigger on the selected line # in field 1 and field 2 (NTSC, PAL, PAL-M, and SECAM only).

- **Vertical** – Trigger on the rising edge of the first serration pulse or approximately 70 μ s after the start of vertical sync, whichever occurs first (only available in Generic mode).
 - **Count: Vertical** – Counts falling edges of sync pulses; triggers on the selected count number (only available in Generic mode).
- 6** If you select a line # mode, press the **Line #** softkey, then rotate the Entry knob to select the line number on which you want to trigger.
 - 7** When using the Generic standard and you select a line # mode or **Count: Vertical**, press the **Count #** softkey and rotate the Entry knob to select the desired count number.

Listed below are the line (or count) numbers per field for each video standard.

Table 6 Line (or count for Generic) numbers per field for each non-HDTV/EDTV video standard

Video standard	Field 1	Field 2	Alt Field
NTSC	1 to 263	1 to 262	1 to 262
PAL	1 to 313	314 to 625	1 to 312
PAL-M	1 to 263	264 to 525	1 to 262
SECAM	1 to 313	314 to 625	1 to 312
Generic	1 to 1024	1 to 1024	1 to 1024 (vertical)

Line Number Represents Count

In **Generic** mode, the line number represents the number of a count instead of a real line number. This is reflected in the label in the softkey changing from **Line** to **Count**. In the **Mode** softkey selections, **Line:Field 1**, **Line:Field 2** and **Count:Vertical** are used to indicate where the counting starts. For an interlaced video signal, the counting starts from the rising edge of the first vertical serration pulse of Field 1 and/or Field 2. For a non-interlaced video signal, the counting starts after the rising edge of the vertical sync pulse.

Table 7 Line numbers for each EDTV/HDTV video standard

EDTV 480p/60	1 to 525
HDTV 720p/60	1 to 750
HDTV 1080p/24	1 to 1125
HDTV 1080p/25	1 to 1125
HDTV 1080i/50	1 to 1125
HDTV 1080i/60	1 to 1125

Example exercises

The following are exercises to familiarize you with TV triggering. These exercises use the NTSC video standard.

To trigger on a specific line of video

TV triggering requires greater than 1/2 division of sync amplitude with any oscilloscope channel as the trigger source. Turning the trigger **Level** knob in TV trigger does not change the trigger level because the trigger level is automatically set to the sync pulse tips.

One example of triggering on a specific line of video is looking at the vertical interval test signals (VITS), which are typically in line 18. Another example is closed captioning, which is typically in line 21.

- 1 Press the Trigger **More** key, then press the **TV** softkey.
- 2 Press the **Settings** softkey, then press the **Standard** softkey to select the appropriate TV standard (NTSC).
- 3 Press the **Mode** softkey and select the TV field of the line you want to trigger on. You can choose **Line:Field1**, **Line:Field2**, or **Line:Alternate**.
- 4 Press the **Line #** softkey and select the number of the line you want to examine.

Alternate Triggering

If **Line:Alternate** is selected, the oscilloscope will alternately trigger on the selected line number in Field 1 and Field 2. This is a quick way to compare the Field 1 VITS and Field 2 VITS or to check for the correct insertion of the half line at the end of Field 1.

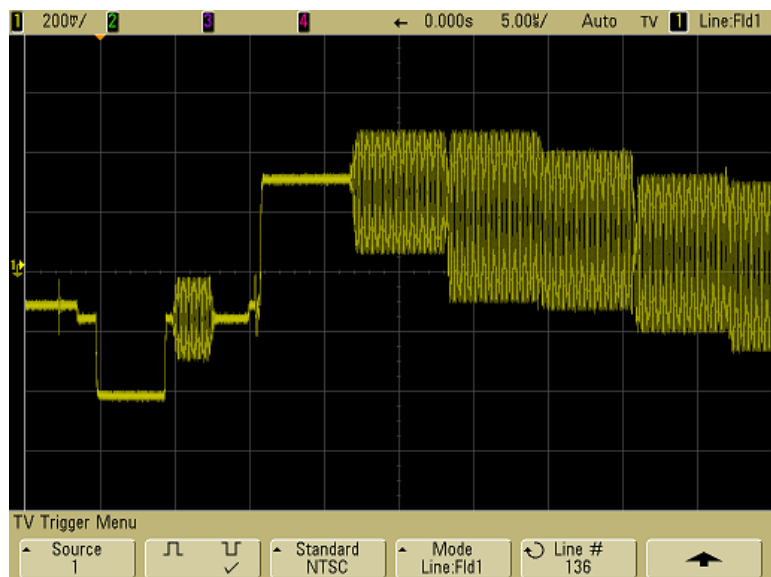

Figure 8 Example: Triggering on Line 136

To trigger on all sync pulses

To quickly find maximum video levels, you could trigger on all sync pulses. When **All Lines** is selected as the TV trigger mode, the oscilloscope will trigger on all horizontal sync pulses.

- 1 Press the Trigger **More** key, then press the **TV** softkey.
- 2 Press the **Settings** softkey, then press the **Standard** softkey to select the appropriate TV standard.
- 3 Press the **Mode** softkey and select **All Lines**.

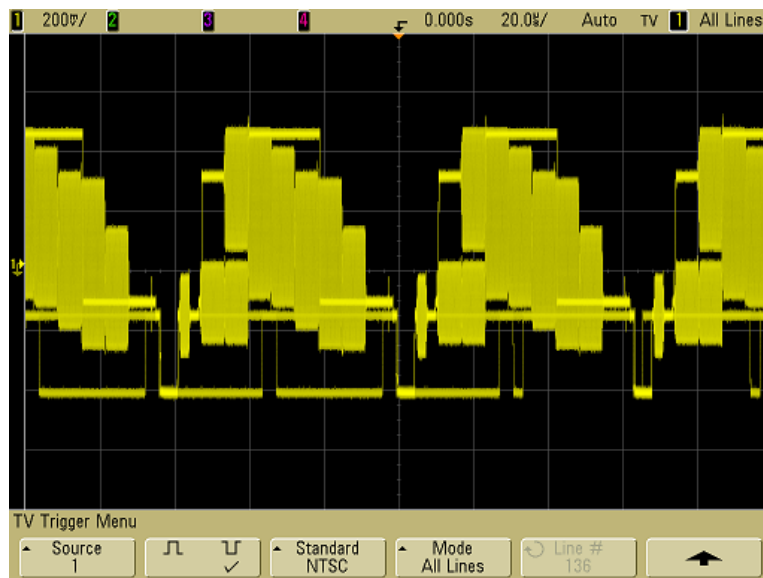

Figure 9 Triggering on All Lines

To trigger on a specific field of the video signal

To examine the components of a video signal, trigger on either Field 1 or Field 2 (available for interleaved standards). When a specific field is selected, the oscilloscope triggers on the rising edge of the first serration pulse in the vertical sync interval in the specified field (1 or 2).

- 1 Press the Trigger **More** key, then press the **TV** softkey.
- 2 Press the **Settings** softkey, then press the **Standard** softkey to select the appropriate TV standard.
- 3 Press the **Mode** softkey and select **Field1** or **Field2**.

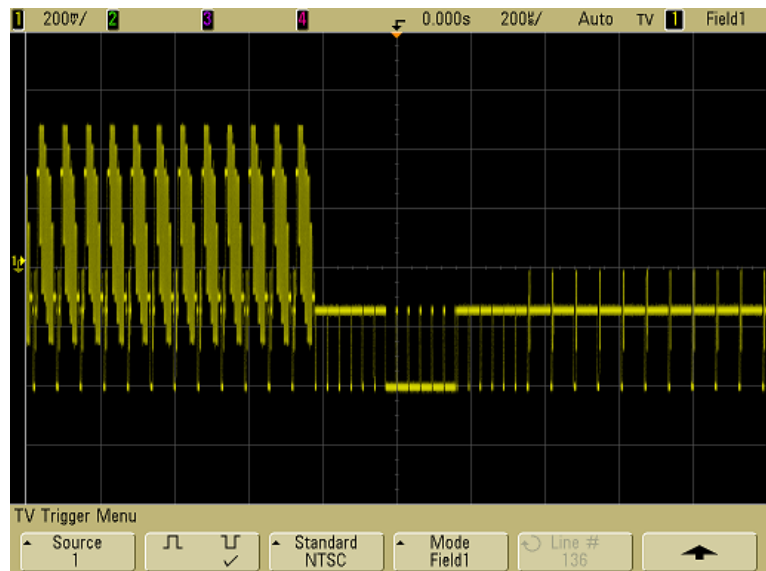

Figure 10 Triggering on Field 1

To trigger on all fields of the video signal

To quickly and easily view transitions between fields, or to find the amplitude differences between the fields, use the All Fields trigger mode.

- 1 Press the Trigger **More** key, then press the **TV** softkey.
- 2 Press the **Settings** softkey, then press the **Standard** softkey to select the appropriate TV standard.
- 3 Press the **Mode** softkey and select **All Fields**.

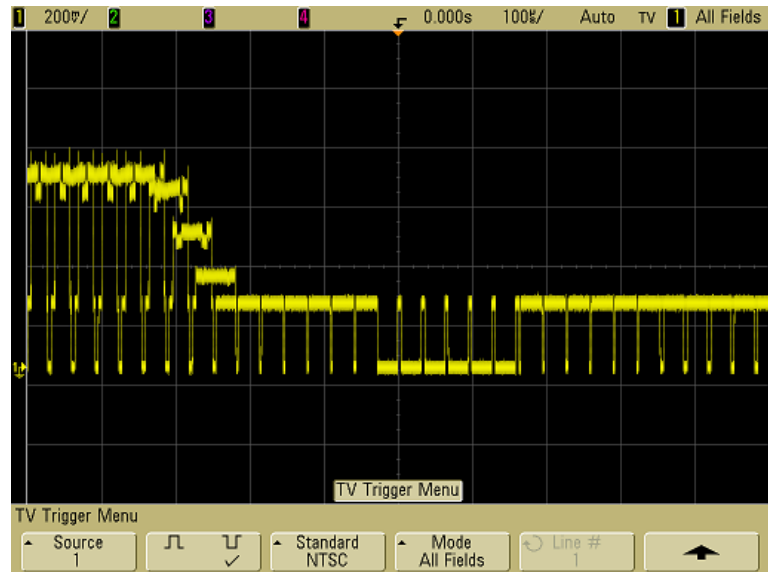

Figure 11 Triggering on All Fields

To trigger on odd or even fields

To check the envelope of your video signals, or to measure worst case distortion, trigger on the odd or even fields. When Field 1 is selected, the oscilloscope triggers on color fields 1 or 3. When Field 2 is selected, the oscilloscope triggers on color fields 2 or 4.

- 1 Press the Trigger **More** key, then press the **TV** softkey.
- 2 Press the **Settings** softkey, then press the **Standard** softkey to select the appropriate TV standard.
- 3 Press the **Mode** softkey and select **Field1** or **Field2**.

The trigger circuits look for the position of the start of Vertical Sync to determine the field. But this definition of field does not take into consideration the phase of the reference subcarrier. When Field 1 is selected, the trigger system will find any field where the vertical sync starts on Line 4. In the case of NTSC video, the oscilloscope will trigger on color field 1 alternating with color field 3 (see the following figure). This setup can be used to measure the envelope of the reference burst.

3 Triggering the Oscilloscope

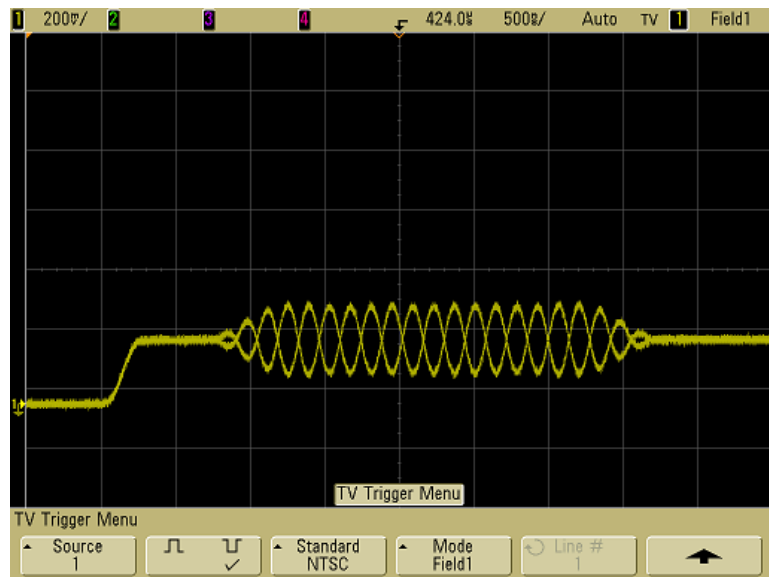

Figure 12 Triggering on Color Field 1 Alternating with Color Field 3

If a more detailed analysis is required, then only one color field should be selected to be the trigger. You can do this by using the **TV Holdoff** softkey in the trigger More Trigger Menu when the trigger type is set to **TV**. Press the **TV Holdoff** softkey and use the Entry knob to adjust the holdoff in half-field increments until the oscilloscope triggers on only one phase of the color burst.

A quick way to synchronize to the other phase is to briefly disconnect the signal and then reconnect it. Repeat until the correct phase is displayed.

When holdoff is adjusted using the **TV Holdoff** softkey and the Entry knob, the corresponding holdoff time will be displayed in the **Mode/Coupling** menu.

Table 8 Half-field holdoff time

Standard	Time
NTSC	8.35 ms
PAL	10 ms
PAL-M	10 ms
SECAM	10 ms
Generic	8.35 ms
EDTV 480p/60	8.35 ms
HDTV 720p/60	8.35 ms
HDTV 1080p/24	20.835 ms
HDTV 1080p/25	20 ms
HDTV 1080i/50	10 ms
HDTV 1080i/60	8.35 ms

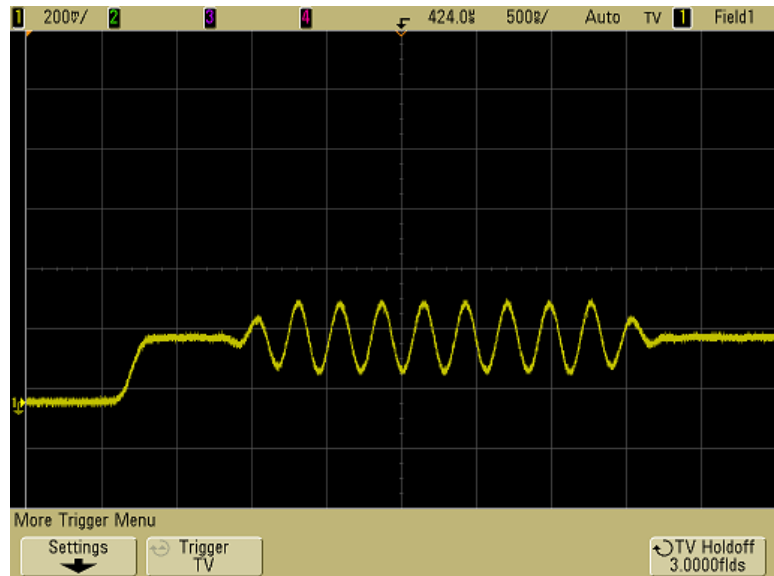

Figure 13 Using TV Holdoff to Synchronize to Color Field 1 or 3 (Field 1 mode)

To use UART/RS232 triggering

NOTE

For UART/RS232 decode setup see [page 239](#).

To trigger on a UART (Universal Asynchronous Receiver/Transmitter) signal connect the oscilloscope to the Rx and Tx lines and set up a trigger condition. RS232 (Recommended Standard 232) is one example of a UART protocol.

- 1 Press the **More** key in the Trigger section of the front panel. Rotate the Entry knob until **UART/RS232** is displayed in the **Trigger** softkey
- 2 Press the **Settings** softkey to display the UART/RS232 trigger menu.

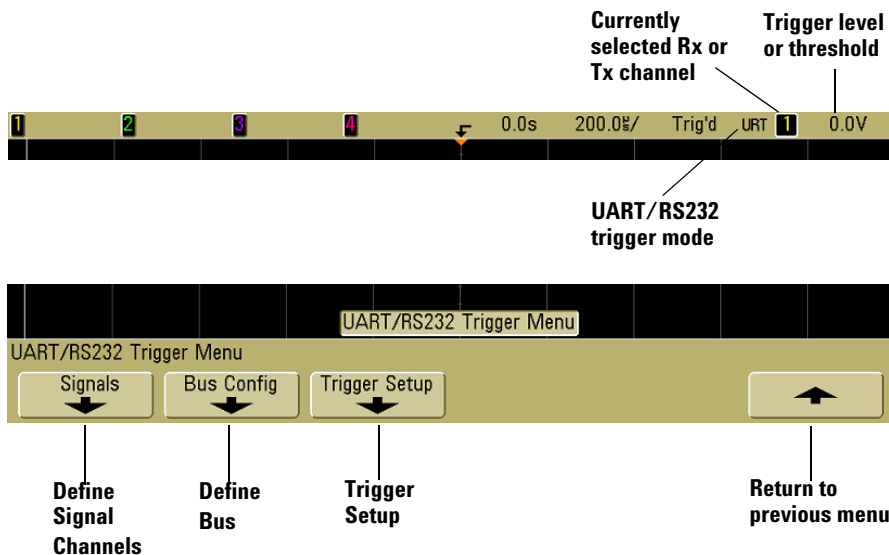

- Press the **Signals** softkey to display the UART/RS232 signals menu.

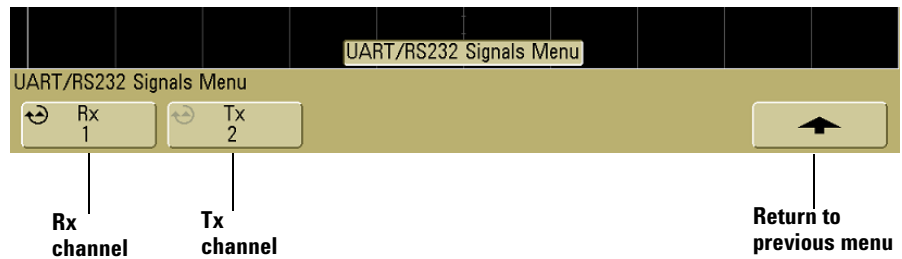

- Connect an oscilloscope channel to the Rx signal in the circuit under test (the target system), then press the **Rx** softkey and rotate the Entry knob to select the channel.
As you press the **Rx** softkey (or rotate the Entry knob on mixed-signal oscilloscopes), the channel you select is shown in the upper-right corner of the display next to “**URT**”.
- Make sure the trigger or threshold levels are set to the middle of the signal:
 - For analog channels, turn the Trigger Level knob.
 - For digital channels, press the **D15-D0** key and the **Thresholds** softkey to access the threshold level setting softkeys.
The value of the trigger level or digital threshold is displayed in the upper-right corner of the display.
- Repeat these two steps for the Tx signal.
- Press the up arrow key to return to the previous menu.

- 8 Press the **Bus Config** softkey and set the following parameters.
 - a **#Bits:** Set the number of bits in the UART/RS232 words to match your target system (selectable from 5-9 bits).
 - b **Parity:** Choose odd, even, or none, based on your target system.
 - c **Baud:** Select the baud rate to match the signal in your target system.
 - d **Polarity:** Select idle low or idle high to match your target system's state when at idle. For RS232 select idle low.
 - e **Bit Order:** Select whether the most significant bit (MSB) or the least significant bit (LSB) is presented after the start bit in the signal from your target system. For RS232 select LSB.
- 9 Press the up arrow key to return to the previous menu.
- 10 Press the **Trigger Setup** softkey and set up the desired trigger condition.
 - **Rx Start Bit:** The oscilloscope triggers when a start bit occurs on Rx.
 - **Rx Stop Bit:** Triggers when a stop bit occurs on Rx. The trigger will occur on the first stop bit. This is done automatically whether the target system uses 1, 1.5, or 2 stop bits. You do not need to specify the number of stop bits used by the target system.
 - **Rx Data:** Triggers on a data byte that you specify. For use when the target system data words are from 5 to 8 bits in length (no 9th (alert) bit).
 - **Rx 1:Data:** For use when the target system data words are 9 bits in length including the alert bit (the 9th bit). Triggers only when the 9th (alert) bit is 1. The specified data byte applies to the least significant 8 bits (excludes the 9th (alert) bit).
 - **Rx 0:Data:** For use when the target system data words are 9 bits in length including the alert bit (the 9th bit). Triggers only when the 9th (alert) bit is 0. The specified data byte applies to the least significant 8 bits (excludes the 9th (alert) bit).

- **Rx X:Data:** For use when the target system data words are 9 bits in length including the alert bit (the 9th bit). Triggers on a data byte that you specify regardless of the value of the 9th (alert) bit. The specified data byte applies to the least significant 8 bits (excludes the 9th (alert) bit).
 - Similar choices are available for Tx.
 - **Rx or Tx Parity Error:** Triggers on a parity error based on the parity you have set in the Bus Configuration Menu.
- 11** If you choose a trigger condition that includes “**Data**” in its description (for example: **Rx Data**) then press the **Data is** softkey and choose an equality qualifier. You can choose equal to, not equal to, less than, or greater than a specific data value.
- 12** Use the **Data** softkey to choose the data value for your trigger comparison. This works in conjunction with the **Data is** softkey.
- 13** Optional: The **Burst** softkey lets you trigger on the Nth frame (1-4096) after an idle time you select. All trigger conditions must be met for the trigger to occur.
- 14** If **Burst** is selected, an idle time (10 μ s to 10 s) can be specified so that the oscilloscope will look for a trigger condition only after the idle time has past. Press the **Idle** softkey and rotate the Entry knob to set an idle time.

3 Triggering the Oscilloscope

15 Remember to set the trigger mode to Normal (press **Mode/Coupling**→**Mode**→**Normal**) to prevent Auto Triggering.

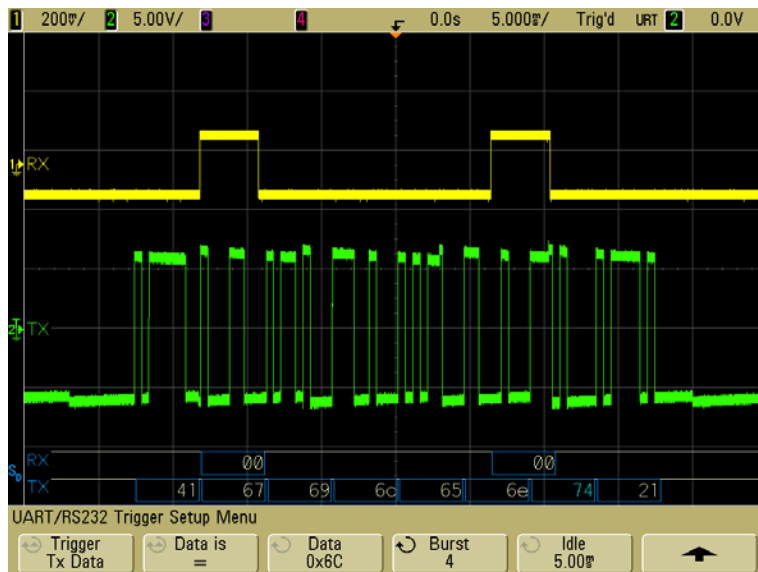

The Trigger Out connector

Each time the oscilloscope triggers, a rising edge is output at the TRIG OUT connector on the rear panel of the oscilloscope. This rising edge is delayed 17 ns from the oscilloscope's trigger point. The output level is 0-5 V into an open circuit, or 0-2.5 V into 50 Ω .

The Trigger Out connector also provides the User Cal signal. See “[User Calibration](#)” on page 82.

3 Triggering the Oscilloscope



4 Making Measurements

To use the XY horizontal mode [150](#)

Math Functions [155](#)

Cursor Measurements [174](#)

Automatic Measurements [181](#)

Post Acquisition Processing

In addition to changing display parameters after the acquisition, you can perform all of the measurements and math functions after the acquisition. Measurements and math functions will be recalculated as you pan and zoom and turn channels on and off. As you zoom in and out on a signal using the horizontal sweep speed knob and vertical volts/division knob, you affect the resolution of the display. Because measurements and math functions are performed on displayed data, you affect the resolution of functions and measurements.



To use the XY horizontal mode

The XY horizontal mode converts the oscilloscope from a volts-versus-time display to a volts-versus-volts display using two input channels. Channel 1 is the X-axis input, channel 2 is the Y-axis input. You can use various transducers so the display could show strain versus displacement, flow versus pressure, volts versus current, or voltage versus frequency. This exercise shows a common use of the XY display mode by measuring the phase difference between two signals of the same frequency with the Lissajous method.

- 1 Connect a sine wave signal to channel 1, and a sine wave signal of the same frequency but out of phase to channel 2.
- 2 Press the **AutoScale** key, press the **Menu/Zoom** key, then press the **XY** softkey.
- 3 Center the signal on the display with the channel 1 and 2 position (\blacklozenge) knobs. Use the channel 1 and 2 volts/div knobs and the channel 1 and 2 **Vernier** softkeys to expand the signal for convenient viewing.

The phase difference angle (θ) can be calculated using the following formula (assuming the amplitude is the same on both channels):

$$\sin\theta = \frac{A}{B} \text{ or } \frac{C}{D}$$

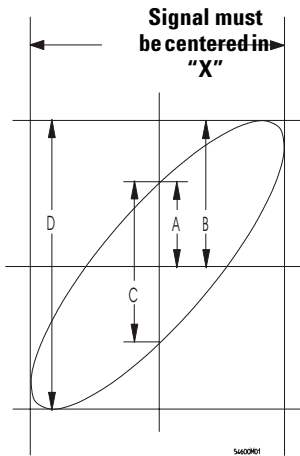

Figure 14 Example of centering a signal on the display

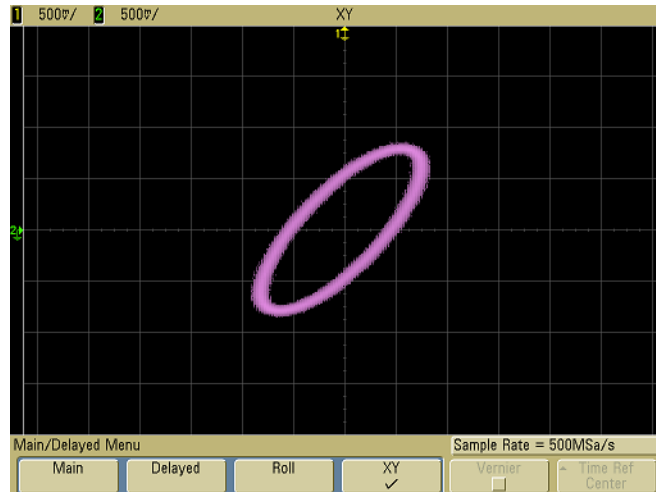

Figure 15 Signal centered on the display

- 4 Press the **Cursors** key.
- 5 Set the Y2 cursor to the top of the signal, and set Y1 to the bottom of the signal.

4 Making Measurements

Note the ΔY value at the bottom of the display. In this example, we are using the Y cursors, but you could have used the X cursors instead.

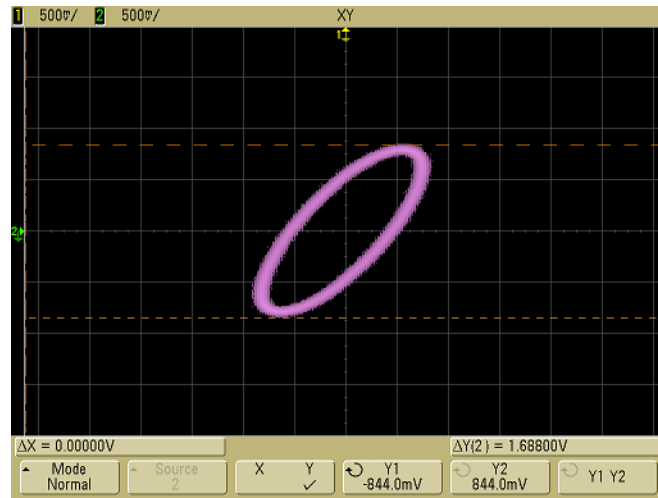

Figure 16 Cursors set on displayed signal

- 6 Move the Y1 and Y2 cursors to the intersection of the signal and the Y axis.

Again, note the ΔY value.

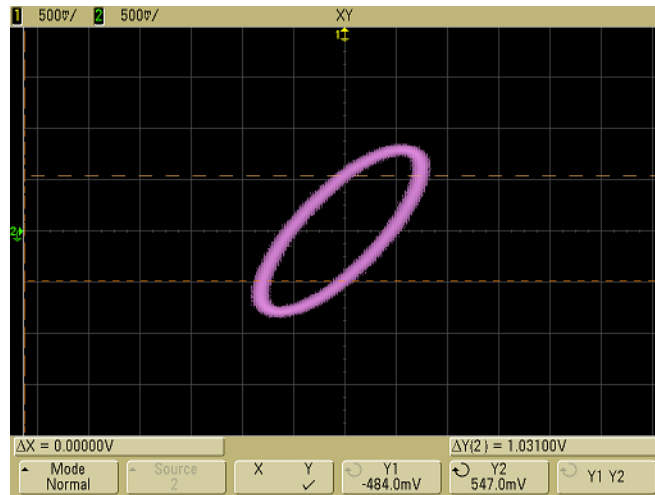

Figure 17 Cursors set to center of signal

7 Calculate the phase difference using the formula below.

$$\sin \theta = \frac{\text{second } \Delta Y}{\text{first } \Delta Y} = \frac{1.031}{1.688} ; \theta = 37.65 \text{ degrees of phase shift}$$

Z-Axis Input in XY Display Mode (Blanking)

When you select the XY display mode, the time base is turned off. Channel 1 is the X-axis input, channel 2 is the Y-axis input, and channel 4 (or the External trigger on 2-channel models) is the Z-axis input. If you only want to see portions of the Y versus X display, use the Z-axis input. Z-axis turns the trace on and off (analog oscilloscopes called this Z-axis blanking because it turned the beam on and off). When Z is low (<1.4 V), Y versus X is displayed; when Z is high (>1.4 V), the trace is turned off.

4 Making Measurements

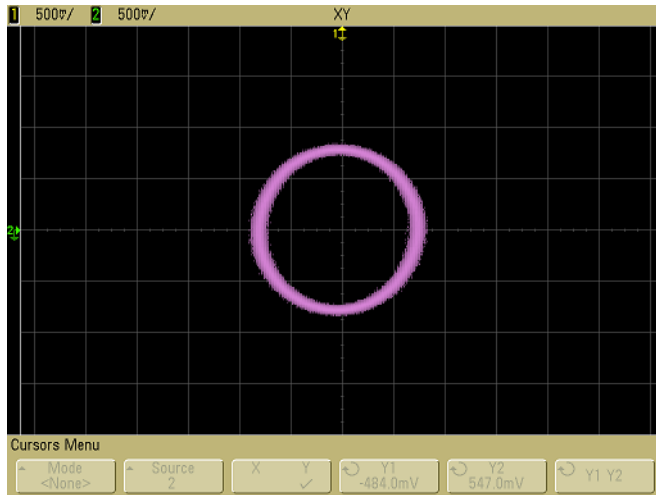

Figure 18 Signals are 90 out of phase

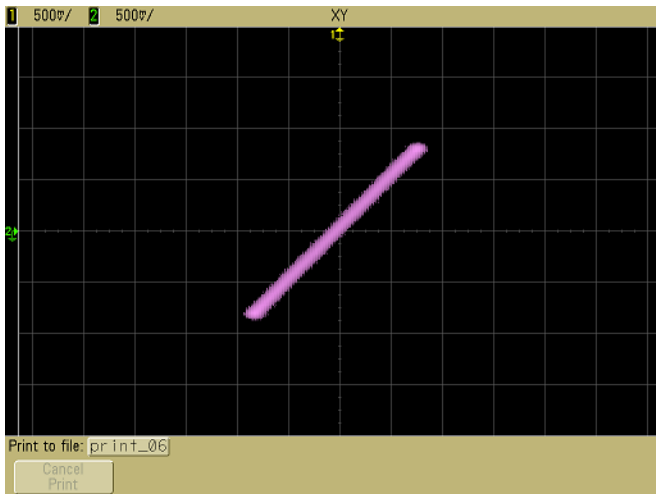

Figure 19 Signals are in phase

Math Functions

The Math menu lets you display math functions on oscilloscope channels. You can:

- subtract (–) or multiply (*) the signals acquired on oscilloscope channels 1 and 2, then display the result.
- integrate, differentiate, perform an FFT, or the square root function on the signal acquired on any channel or on math functions $1 * 2$, $1 - 2$, or $1 + 2$, then display the result.

To access math functions:

- 1 Press the **Math** key on the front panel to display the Waveform Math Menu.
- 2 Press the **Function** sofkey and use the Entry knob (or keep pressing the **Function** sofkey) to select the desired math function.

After selecting a math function, softkeys for changing that math function's settings appear in the Waveform Math Menu.

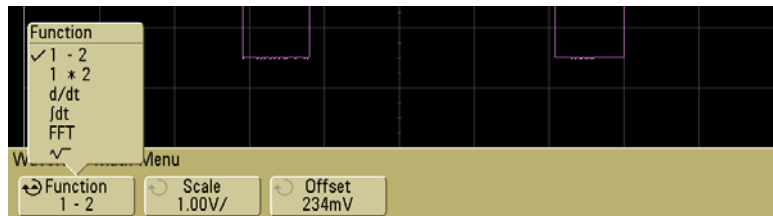

Math Operating Hints

If the oscilloscope channel or math function is clipped (not fully displayed on screen,) the resulting displayed math function will also be clipped.

Once the function is displayed, the oscilloscope channel(s) may be turned off for better viewing.

The vertical scaling and offset of each math function can be adjusted for ease of viewing and measurement considerations.

Each function can be measured in the Cursors and Quick Meas menus.

Math scale and offset

Any math function may be manually scaled by pressing the **Settings** softkey, and then adjusting the Scale or Offset value.

Math Scale and Offset are Set Automatically

Any time the currently displayed math function definition is changed, the function is automatically scaled for optimum vertical scale and offset. If you manually set scale and offset for a function, select a new function, then select the original function, the original function will be automatically rescaled.

- 1 In the Waveform Math Menu for the selected math function, press the **Scale** or **Offset** softkeys to set your own scale factors (units/division) or offset (units) for the selected math function.

Units for each input channel can be set to Volts or Amps using the channel **Probe Units** softkey. Scale and offset units are:

Math function	Units
FFT	dB* (decibels)
1*2	V ² , A ² , or W (Volt-Amp)
1-2	V or A
d/dt	V/s or A/s (V/second or A/second)
∫ dt	Vs or As (V-seconds or A-seconds)
√ (square root)	V ^{1/2} , A ^{1/2} , or W ^{1/2} (Volt-Amp)

* When the FFT source is channel 1, 2, 3 or 4, FFT units will be displayed in dBV when channel units is set to Volts and channel impedance is set to 1 MΩ. FFT units will be displayed in dBm when channel units is set to Volts and channel impedance is set to 50Ω. FFT units will be displayed as dB for all other FFT sources or when a source channel's units has been set to Amps.

A scale unit of **U** (undefined) will be displayed for math function 1-2 and for d/dt, and ∫ dt when 1-2 or 1+2 is the selected source if channel 1 and channel 2 are set to dissimilar units in the channel **Probe Units** softkey.

- 2 Press the **Scale** or **Offset** softkey, then turn the Entry knob to rescale or change the offset value for your math function.

Multiply

When you select **1 * 2**, channel 1 and channel 2 voltage values are multiplied point by point, and the result is displayed. **1 * 2** is useful for seeing power relationships when one of the channels is proportional to the current.

- 1 Press the **Math** key, press the **1 * 2** softkey, then press the **Settings** softkey if you want to change the scaling or offset for the multiply function.
 - **Scale** – lets you set your own vertical scale factors for multiply expressed as V^2/div (Volts-squared/division), A^2/div (Amps-squared/division), or W/div (Watts/division or Volt-Amps/division). Units are set in the channel **Probe** menu. Press the **Scale** softkey, then turn the Entry knob to rescale **1 * 2**.
 - **Offset** – lets you set your own offset for the multiply math function. The offset value is in V^2 (Volts-squared), A^2 (Amps-squared), or W (Watts) and is represented by the center horizontal grid line of the display. Press the **Offset** softkey, then turn the Entry knob to change the offset for **1 * 2**.

The figure below shows an example of multiply.

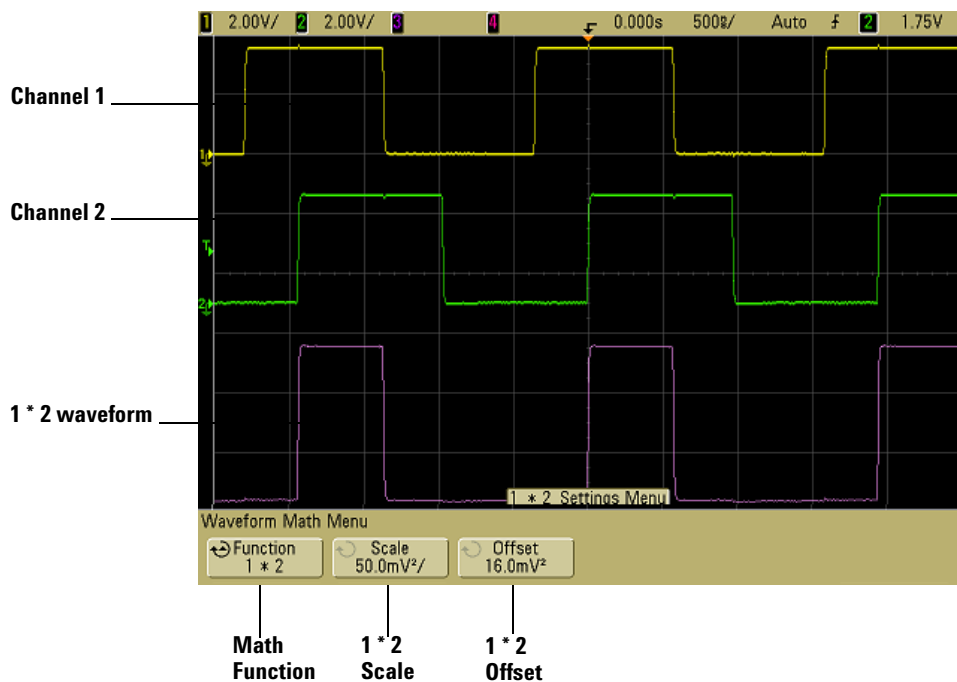

Figure 20 Multiply

Subtract

When you select **1 – 2**, channel 2 voltage values are subtracted from channel 1 voltage values point by point, and the result is displayed.

You can use **1 – 2** to make a differential measurement or to compare two waveforms. You may need to use a true differential probe if your waveforms have DC offsets larger than the dynamic range of the oscilloscope's input channel.

To perform the addition of channel 1 and channel 2, select **Invert** in the Channel 2 menu and perform the **1 – 2** math function.

1 Press the **Math** key, press the **1 – 2** softkey, then press the **Settings** softkey if you want to change the scaling or offset for the subtract function.

- **Scale** – lets you set your own vertical scale factors for subtract, expressed as V/div (Volts/division) or A/div (Amps/division). Units are set in the channel **Probe** menu. Press the **Scale** softkey, then turn the Entry knob to rescale **1 – 2**.
- **Offset** – lets you set your own offset for the **1 – 2** math function. The offset value is in Volts or Amps and is represented by the center horizontal grid line of the display. Press the **Offset** softkey, then turn the Entry knob to change the offset for **1 – 2**.

A scale unit of **U** (undefined) will be displayed for scale and offset if channel 1 and channel 2 are set to dissimilar units in the channel **Probe Units** softkey.

The figure below shows an example of subtract.

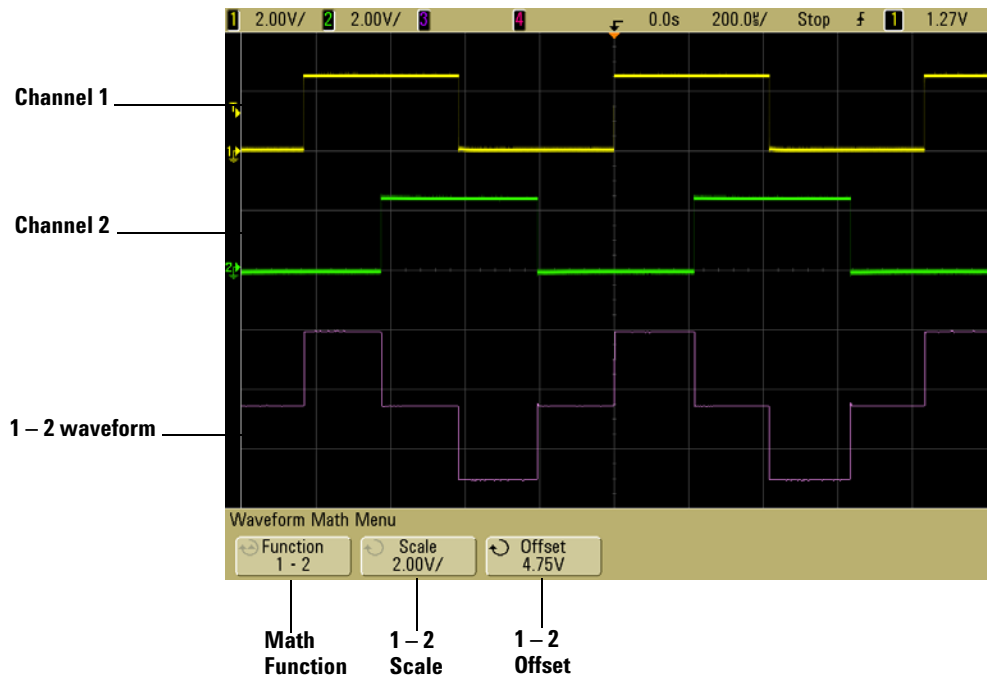

Figure 21 Subtract

Differentiate

d/dt (differentiate) calculates the discrete time derivative of the selected source. You can use differentiate to measure the instantaneous slope of a waveform. For example, the slew rate of an operational amplifier may be measured using the differentiate function.

Because differentiation is very sensitive to noise, it is helpful to set acquisition mode to **Averaging** in the **Acquire** menu.

d/dt plots the derivative of the selected source using the “average slope estimate at 4 points” formula. The equation is:

$$d_i = \frac{y_{i+4} + 2y_{i+2} - 2y_{i-2} - y_{i-4}}{8\Delta t}$$

Where

d = differential waveform

y = channel 1, 2, or function 1 + 2, 1 - 2, and 1 * 2 data points

i = data point index

Δt = point-to-point time difference

In Zoom mode, the d/dt function does not display in the zoomed portion of the display.

- 1 Press the **Math** key, press the **d/dt** softkey, then press the **Settings** softkey if you want to change the source, scaling, or offset for the differentiate function.
 - **Source** – selects the source for d/dt. The source can be any oscilloscope channel, or math functions 1 + 2, 1 - 2, and 1 * 2.
 - **Scale** – lets you set your own vertical scale factors for d/dt expressed in units/second/division, where units can be V (Volts), A (Amps), or W (Watts). Units are set in the channel **Probe** menu. Press the **Scale** softkey, then turn the Entry knob to rescale d/dt.

- **Offset** –lets you set your own offset for the dV/dt math function. The offset value is in units/second where units can be V (Volts), A (Amps), or W (Watts) and is represented by the center horizontal grid line of the display. Press the **Offset** softkey, then turn the Entry knob to change the offset for d/dt .

A scale unit of **U** (undefined) will be displayed for scale and offset when 1-2 or 1+2 is the selected source if channel 1 and channel 2 are set to dissimilar units in the channel **Probe Units** softkey.

The figure below shows an example of differentiate.

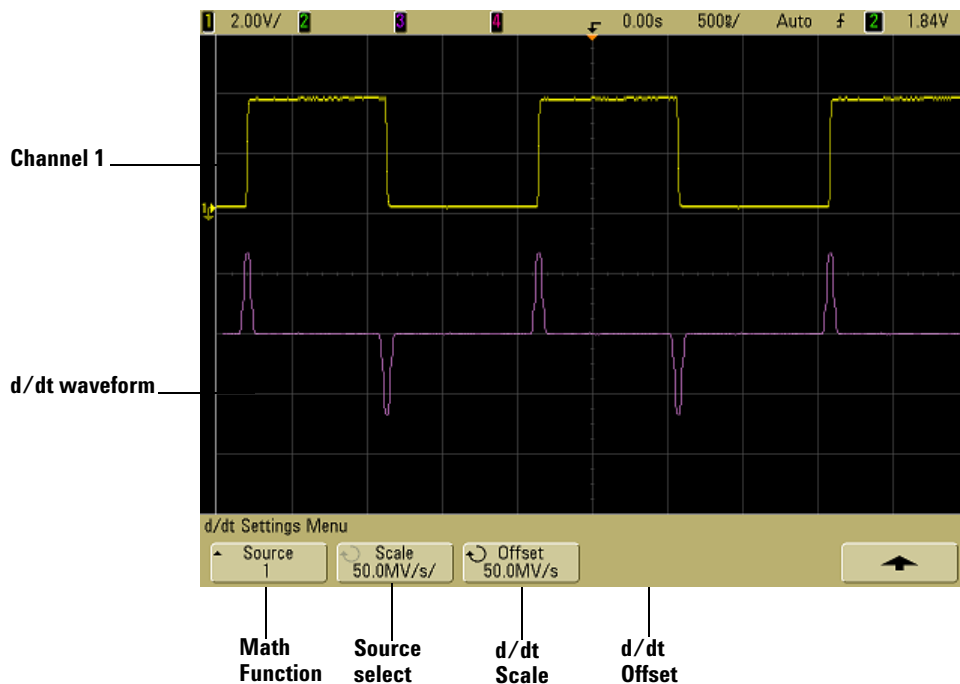

Figure 22 Differentiate

Integrate

$\int dt$ (integrate) calculates the integral of the selected source. You can use integrate to calculate the energy of a pulse in volt-seconds or measure the area under a waveform.

$\int dt$ plots the integral of the source using the “Trapezoidal Rule”. The equation is:

$$I_n = c_0 + \Delta t \sum_{i=0}^n y_i$$

Where

I = integrated waveform

Δt = point-to-point time difference

y = channel 1, 2, or function 1 + 2, 1 – 2, and 1 * 2 data points

c_0 = arbitrary constant

i = data point index

In Zoom mode, the $\int dt$ function does not display in the zoomed portion of the display.

- 1 Press the **Math** key, press the $\int dt$ softkey, then press the **Settings** softkey if you want to change the source, scaling, or offset for the integrate function.
 - **Source** – selects the source for $\int dt$. The source can be any oscilloscope channel, or math functions 1 + 2, 1 – 2, and 1 * 2.
 - **Scale** – lets you set your own vertical scale factors for $\int dt$ expressed in unit-seconds/division, where units can be V (Volts), A (Amps), or W (Watts). Units are set in the channel **Probe** menu. Press the **Scale** softkey, then turn the Entry knob to rescale $\int dt$.
 - **Offset** – lets you set your own offset for the $\int Vdt$ math function. The offset value is in unit-seconds where units can be V (Volts), A (Amps), or W (Watts) and is represented by the center horizontal grid line of the display. Press the **Offset** softkey, then turn the Entry knob to change the offset for $\int dt$. The integrate calculation is relative to the source signal’s offset. The following examples illustrate the effects of signal offset.

4 Making Measurements

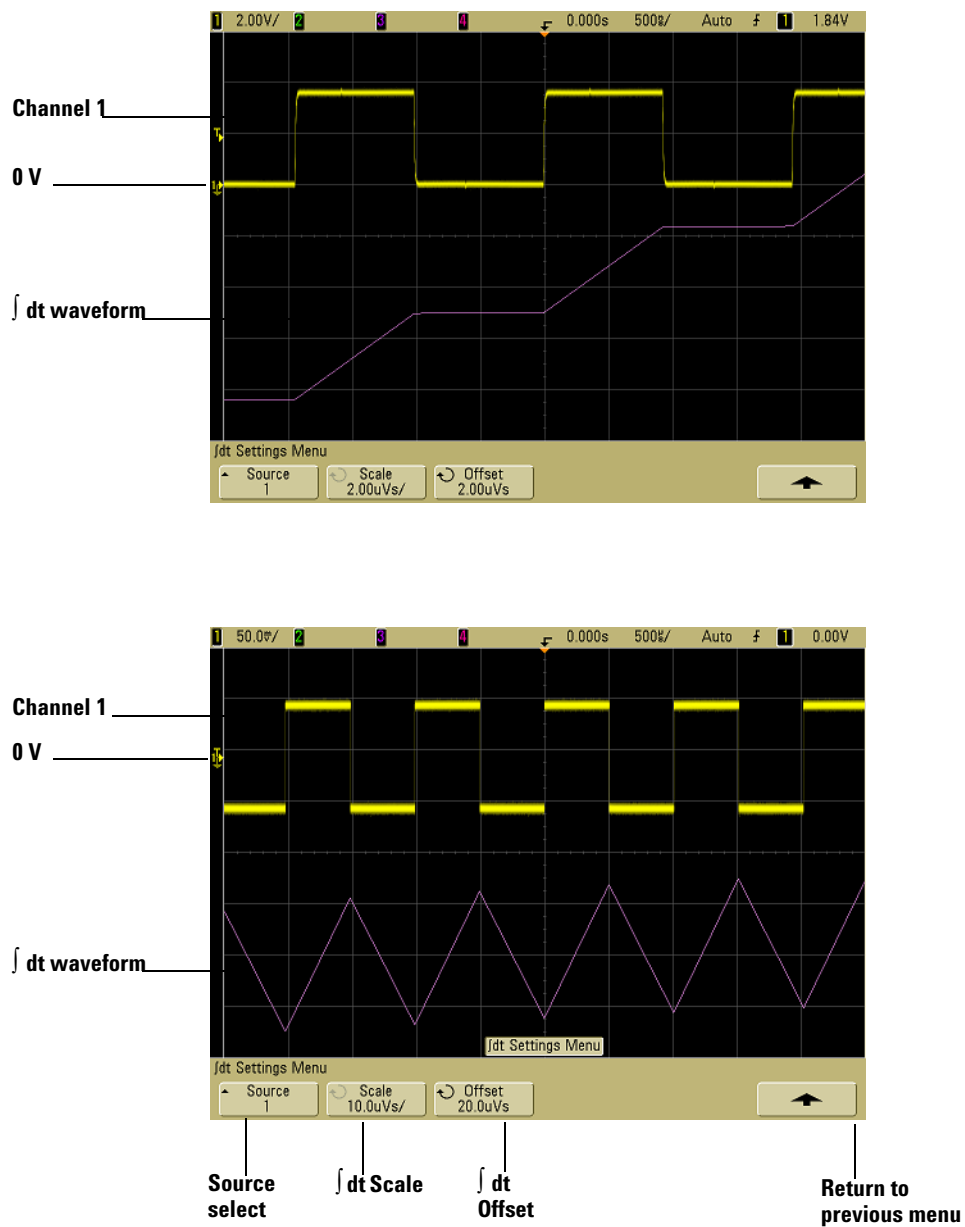

Figure 23 Integrate and Signal Offset

FFT Measurement

FFT is used to compute the fast Fourier transform using oscilloscope input channels or math functions 1 + 2, 1 - 2, or 1 * 2. FFT takes the digitized time record of the specified source and transforms it to the frequency domain. When the FFT function is selected, the FFT spectrum is plotted on the oscilloscope display as magnitude in dBV versus frequency. The readout for the horizontal axis changes from time to frequency (Hertz) and the vertical readout changes from volts to dB.

Use the FFT function to find crosstalk problems, to find distortion problems in analog waveforms caused by amplifier non-linearity, or for adjusting analog filters.

FFT Units

0 dBV is the amplitude of a 1 Vrms sinusoid. When the FFT source is channel 1 or channel 2 (or channel 3 or 4 on 4-channel models), FFT units will be displayed in dBV when channel units is set to Volts and channel impedance is set to 1 M Ω .

FFT units will be displayed in dBm when channel units is set to Volts and channel impedance is set to 50 Ω .

FFT units will be displayed as dB for all other FFT sources or when a source channel's units has been set to Amps.

DC Value

The FFT computation produces a DC value that is incorrect. It does not take the offset at center screen into account. The DC value is not corrected in order to accurately represent frequency components near DC.

Aliasing

When using FFTs, it is important to be aware of frequency aliasing. This requires that the operator have some knowledge as to what the frequency domain should contain, and also consider the sampling rate, frequency span, and oscilloscope

vertical bandwidth when making FFT measurements. The FFT sample rate is displayed directly above the softkeys when the FFT menu is displayed.

Aliasing happens when there are frequency components in the signal higher than half the sample rate. Since the FFT spectrum is limited by this frequency, any higher components are displayed at a lower (aliased) frequency.

The following figure illustrates aliasing. This is the spectrum of a 990 Hz square wave, which has many harmonics. The FFT sample rate is set to 100 kSa/s, and the oscilloscope displays the spectrum. The displayed waveform shows the components of the input signal above the Nyquist frequency to be mirrored (aliased) on the display and reflected off the right edge.

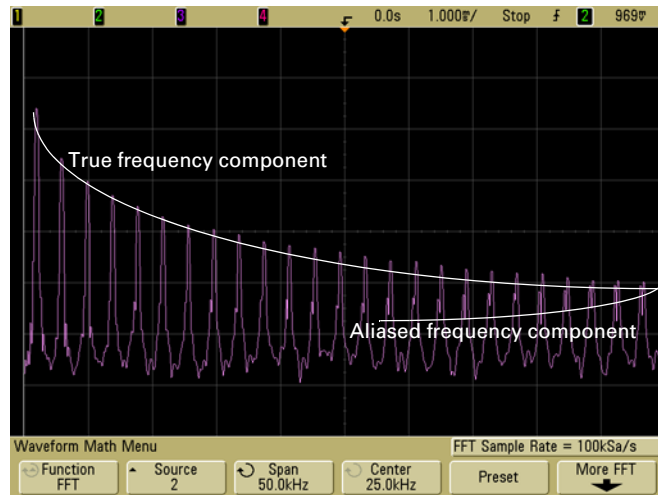

Figure 24 Aliasing

Since the frequency span goes from ≈ 0 to the Nyquist frequency, the best way to prevent aliasing is to make sure that the frequency span is greater than the frequencies of significant energy present in the input signal.

Spectral Leakage

The FFT operation assumes that the time record repeats. Unless there is an integral number of cycles of the sampled waveform in the record, a discontinuity is created at the end of the record. This is referred to as leakage. In order to minimize spectral leakage, windows that approach zero smoothly at the beginning and end of the signal are employed as filters to the FFT. The FFT menu provides three windows: Hanning, flattop, and rectangular. For more information on leakage, see Agilent Application Note 243, “The Fundamentals of Signal Analysis” at <http://cp.literature.agilent.com/litweb/pdf/5952-8898E.pdf>.

FFT Operation

- 1 Press the **Math** key, press the **FFT** softkey, then press the **Settings** softkey to display the FFT menu.

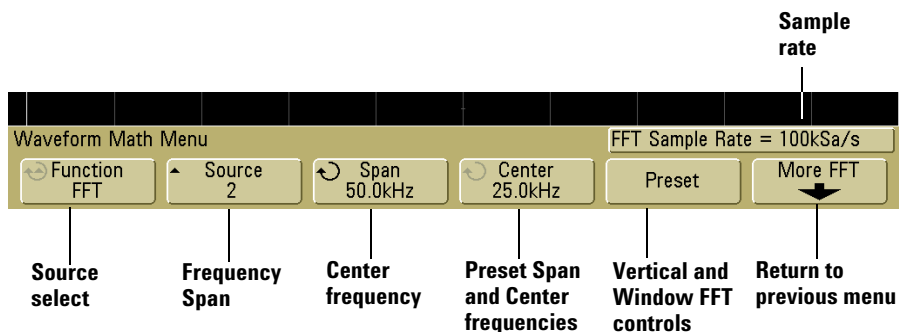

- **Source** – selects the source for the FFT. The source can be any oscilloscope channel, or math functions $1 + 2$, $1 - 2$, and $1 * 2$.
- **Span** – sets the overall width of the FFT spectrum that you see on the display (left to right). Divide span by 10 to calculate the number of Hertz per division. It is possible to set Span above the maximum available frequency, in which case the displayed spectrum will not take up the whole screen. Press the **Span** softkey, then turn the Entry knob to set the desired frequency span of the display.

- **Center** – sets the FFT spectrum frequency represented at the center vertical grid line of the display. It is possible to set the Center to values below half the span or above the maximum available frequency, in which case the displayed spectrum will not take up the whole screen. Press the **Center** softkey, then turn the Entry knob to set the desired center frequency of the display.
- **Preset** – sets the frequency Span and Center to values that will cause the entire available spectrum to be displayed. The maximum available frequency is half the effective FFT sample rate, which is a function of the time per division setting. The current FFT sample rate is displayed above the softkeys.

2 Press the More FFT softkey to display additional FFT settings.

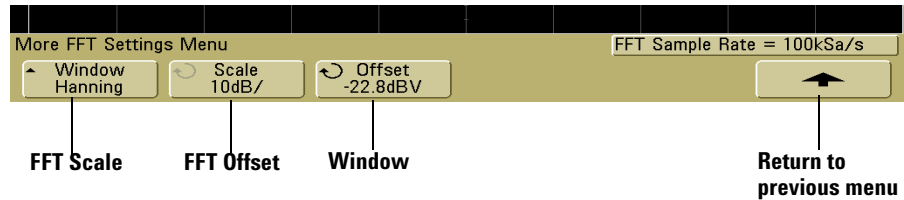

- **Scale** – lets you set your own vertical scale factors for FFT expressed in dB/div (decibels/division). Press the **Scale** softkey, then turn the Entry knob to rescale your math function.
- **Offset** – lets you set your own offset for the FFT. The offset value is in dB and is represented by the center horizontal grid line of the display. Press the **Offset** softkey, then turn the Entry knob to change the offset of your math function

Scale and offset considerations

If you do not manually change the FFT scale or offset settings, when you turn the horizontal sweep speed knob, the span and center frequency settings will automatically change to allow optimum viewing of the full spectrum. If you do manually set scale or offset, turning the sweep speed knob will not change the span or center frequency settings, allowing you see better detail around a specific frequency. Pressing the FFT **Preset** softkey will automatically rescale the waveform and span and center will again automatically track the horizontal sweep speed setting.

- **Window** – selects a window to apply to your FFT input signal:
- **Hanning** – window for making accurate frequency measurements or for resolving two frequencies that are close together.
- **Flat Top** – window for making accurate amplitude measurements of frequency peaks.
- **Rectangular** – good frequency resolution and amplitude accuracy, but use only where there will be no leakage effects. Use on self-windowing waveforms such as pseudo-random noise, impulses, sine bursts, and decaying sinusoids.

- 3** To make cursors measurements, press the **Cursors** key and set the **Source** softkey to **Math**.

Use the X1 and X2 cursors to measure frequency values and difference between two frequency values (ΔX). Use the Y1 and Y2 cursors to measure amplitude in dB and difference in amplitude (ΔY).

- 4** To make other measurements, press the **Quick Meas** key and set the **Source** softkey to **Math**.

You can make peak-to-peak, maximum, minimum, and average dB measurements on the FFT waveform. You can also find the frequency value at the first occurrence of the waveform maximum by using the X at Max measurement.

The following FFT spectrum was obtained by connecting the front panel Probe Comp signal (~ 1.2 kHz) to channel 1. Set sweep speed to 5 ms/div, vertical sensitivity to 500 mV/div, Units/div to 10 dBV, Offset to -34.0 dBV, Center frequency to 5.00 kHz, frequency Span to 10.0 kHz, and window to Hanning.



Figure 25 FFT measurements

FFT Measurement Hints

The number of points acquired for the FFT record is 1000 and when frequency span is at maximum, all points are displayed. Once the FFT spectrum is displayed, the frequency span and center frequency controls are used much like the controls of a spectrum analyzer to examine the frequency of interest in greater detail. Place the desired part of the waveform at the center of the screen and decrease frequency span to increase the display resolution. As frequency span is decreased, the number of points shown is reduced, and the display is magnified.

While the FFT spectrum is displayed, use the **Math** and **Cursors** keys to switch between measurement functions and frequency domain controls in FFT menu.

Decreasing the effective sampling rate by selecting a slower sweep speed will increase the low frequency resolution of the FFT display and also increase the chance that an alias will be displayed. The resolution of the FFT is the effective sample rate divided by the number of points in the FFT. The actual resolution of the display will not be this fine as the shape of the window will be the actual limiting factor in the FFT's ability to resolve two closely spaced frequencies. A good way to test the ability of the FFT to resolve two closely spaced frequencies is to examine the sidebands of an amplitude modulated sine wave.

For the best vertical accuracy on peak measurements:

- Make sure the probe attenuation is set correctly. The probe attenuation is set from the Channel menu if the operand is a channel.
- Set the source sensitivity so that the input signal is near full screen, but not clipped.
- Use the Flat Top window.
- Set the FFT sensitivity to a sensitive range, such as 2 dB/division.

For best frequency accuracy on peaks:

- Use the Hanning window.
- Use Cursors to place an X cursor on the frequency of interest.
- Adjust frequency span for better cursor placement.
- Return to the Cursors menu to fine tune the X cursor.

For more information on the use of FFTs please refer to Agilent Application Note 243, "The Fundamentals of Signal Analysis" at <http://cp.literature.agilent.com/litweb/pdf/5952-8898E.pdf>. Additional information can be obtained from Chapter 4 of the book "Spectrum and Network Measurements" by Robert A. Witte.

Square Root

$\sqrt{\quad}$ (square root) calculates the square root of the selected source.

In Zoom mode, the $\sqrt{\quad}$ (square root) function does not display in the zoomed portion of the display.

- 1 Press the **Math** key, press the $\sqrt{\quad}$ (square root) softkey, then press the **Source**, **Scale**, or **Offset** softkeys if you want to change the source, scaling, or offset for the square root function.
 - **Source** – selects the source for $\sqrt{\quad}$ (square root). The source can be any analog channel, or math functions 1 + 2, 1 - 2, and 1 * 2.
 - **Scale** – lets you set your own vertical scale factors for $\sqrt{\quad}$ (square root) expressed as $V^{1/2}/\text{div}$ (Volts-square-root/division), $A^{1/2}/\text{div}$ (Amps-square-root/division), or $W^{1/2}/\text{div}$ (Watts-square-root/division or Volt-Amps-square-root/division). Units are set in the channel **Probe** menu. Press the **Scale** softkey, then turn the Entry knob to rescale $\sqrt{\quad}$ (square root).
 - **Offset** – lets you set your own offset for the multiply math function. The offset value is in $V^{1/2}$ (Volts-square-root), $A^{1/2}$ (Amps-square-root), or $W^{1/2}$ (Watts-square-root) and is represented by the center horizontal grid line of the display. Press the **Offset** softkey, then turn the Entry knob to change the offset for $\sqrt{\quad}$ (square root).

A scale unit of **U** (undefined) will be displayed for scale and offset when 1-2 or 1+2 is the selected source if channel 1 and channel 2 are set to dissimilar units in the channel **Probe Units** softkey.

The figure below shows an example of $\sqrt{\quad}$ (square root).

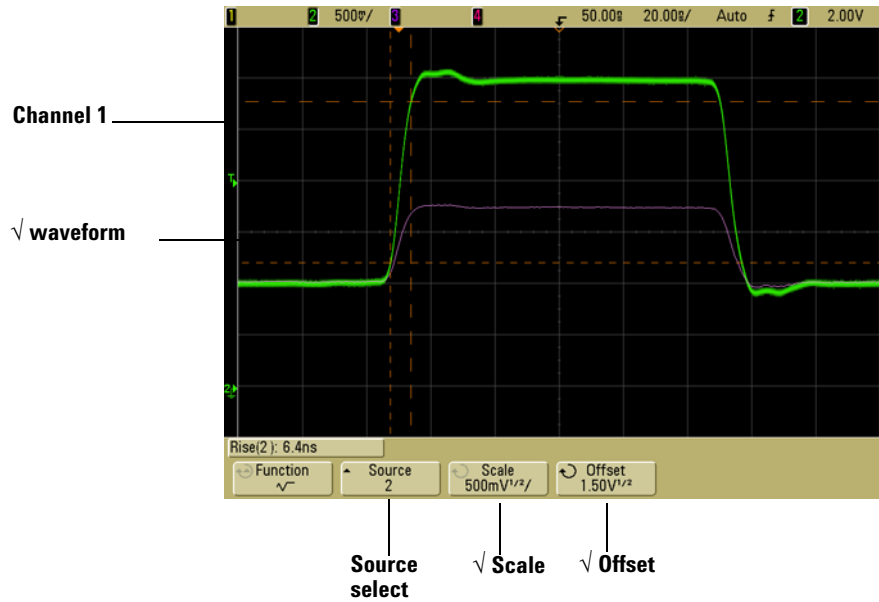

Figure 26 Square Root

Cursor Measurements

You can measure waveform data using cursors. Cursors are horizontal and vertical markers that indicate X-axis values (usually time) and Y-axis values (usually voltage) on a selected waveform source. The position of the cursors can be moved by turning the Entry knob. When you press the **Cursors** key, it will illuminate and the cursors will turn on. To turn cursors off, press this key again until it is not illuminated, or press the **Quick Meas** key.

Cursors are not always limited to the visible display. If you set a cursor, then pan and zoom the waveform until the cursor is off screen, its value will not be changed, and if you pan the waveform back again it will have the cursor in the original place.

To make cursor measurements

A brief description of how to make cursor measurements is given on [page 72](#).

The following steps guide you through using the front-panel **Cursors** key. You can use the cursors to make custom voltage or time measurements on the signal.

- 1 Connect a signal to the oscilloscope and obtain a stable display.
- 2 Press the **Cursors** key, then press the **Mode** softkey.

X and Y cursor information is displayed on the softkeys. ΔX , $1/\Delta X$, ΔY , and binary and hexadecimal values are displayed on the line above the softkeys. The three cursors modes are:

- **Normal** – ΔX , $1/\Delta X$, and ΔY values are displayed. ΔX is the difference between the X1 and X2 cursors and ΔY is the difference between the Y1 and Y2 cursors.

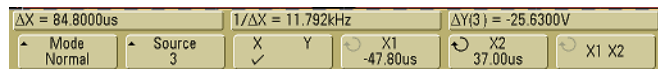

- **Binary** – Binary logic levels are displayed directly above the softkeys for the current X1 and X2 cursor positions for all displayed channels.

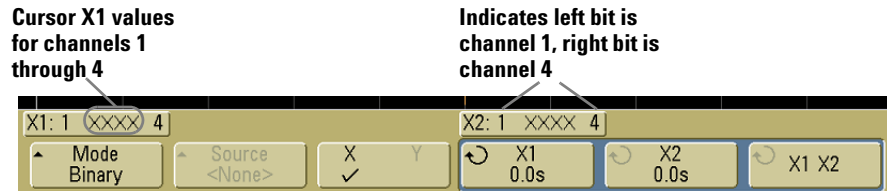

- **Hex** – Hexadecimal logic levels are displayed directly above the softkeys for the current X1 and X2 cursor positions for all displayed channels.

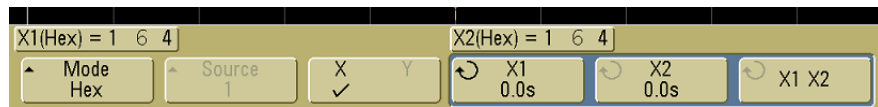

In hexadecimal and binary mode, a level can display as 1 (higher than trigger level), 0 (lower than trigger level), indeterminate state (\updownarrow), or X (don't care). In binary mode, X is displayed if the channel is turned off. In hex mode, the channel is interpreted as a 0 if turned off.

- 3 Press the **Source** softkey to select the oscilloscope channel or math source on which the Y cursors will indicate measurements.

The source in **Normal** cursor mode can be any oscilloscope channel or math source. If you select binary or hexadecimal mode, the **Source** softkey is disabled since you are displaying binary or hexadecimal levels for all channels.

4 Select the X and Y softkeys to make a measurement.

- **X Y** – Press this softkey to select either X cursors or Y cursors for adjustment. The cursor currently assigned to the Entry knob displays brighter than the other cursors.

X cursors are vertical dashed lines that adjust horizontally and normally indicate time relative to the trigger point. When used with the FFT math function as a source, the X cursors indicate frequency.

Y cursors are horizontal dashed lines that adjust vertically and normally indicate Volts or Amps, dependent on the channel **Probe Units** setting. When math functions are used as a source, the measurement units correspond to that math function.

- **X1** and **X2** – The X1 cursor (short-dashed vertical line) and X2 cursor (long-dashed-vertical line) adjust horizontally and indicate time relative to the trigger point for all sources except math FFT (frequency is indicated). In XY horizontal mode, the X cursors display channel 1 values (Volts or Amps). The cursor values for the selected waveform source are displayed within the X1 and X2 softkeys.

The difference between X1 and X2 (ΔX) and $1/\Delta X$ are displayed on the dedicated line above the softkeys or in the display area when some menus are selected.

Turn the Entry knob to adjust the X1 or X2 cursor when its softkey is selected.

- **Y1** and **Y2** – The Y1 cursor (short-dashed horizontal line) and Y2 cursor (long-dashed horizontal line) adjust vertically and indicate values relative to the waveform's ground point, except math FFT where the values are relative to 0 dB. In XY horizontal mode, the Y cursors display channel 2 values (Volts or Amps). The cursor values for the selected waveform source are displayed within the Y1 and Y2 softkeys.

The difference between Y1 and Y2 (ΔY) is displayed on the dedicated line above the softkeys or in the display area when some menus are selected.

Turn the Entry knob to adjust the Y1 or Y2 cursor when its softkey is selected.

- **X1 X2** – Press this softkey to adjust the X1 and X2 cursors together by turning the Entry knob. The ΔX value will remain the same since the cursors adjust together.

You can adjust the X cursors together to check for pulse width variations in a pulse train.

- **Y1 Y2** – Press this softkey to adjust the Y1 and Y2 cursors together by turning the Entry knob. The ΔY value will remain the same since the cursors adjust together.

Cursor Examples

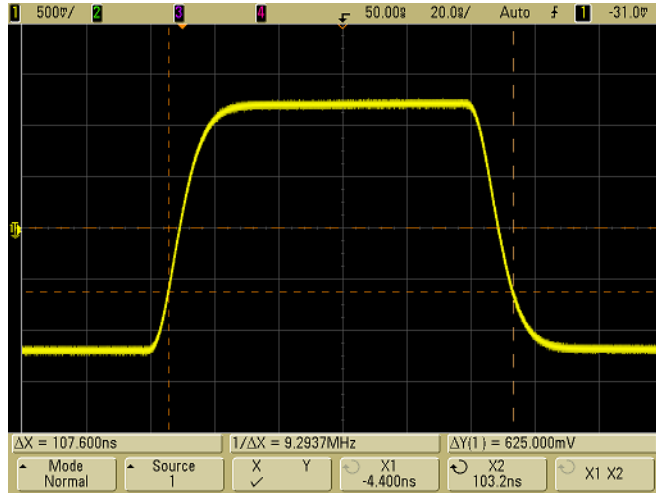

Figure 27 Cursors measure pulse widths other than middle threshold points

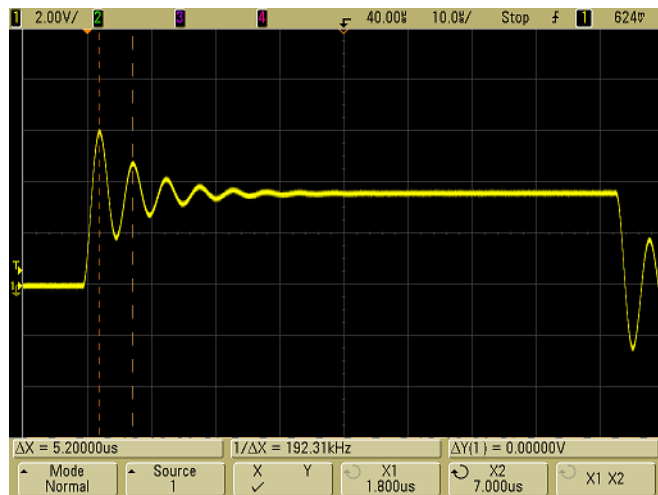

Figure 28 Cursors measure frequency of pulse ringing

Expand the display with zoom mode, then characterize the event of interest with the cursors.

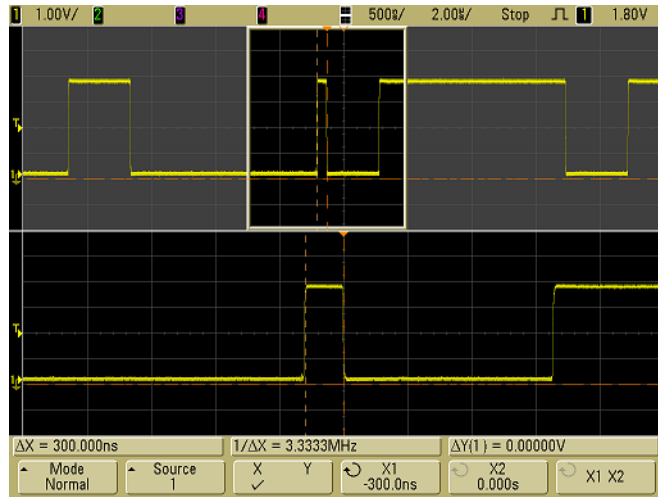

Figure 29 Cursors track zoom sweep

Put the **X1** cursor on one side of a pulse and the **X2** cursor on the other side of the pulse.

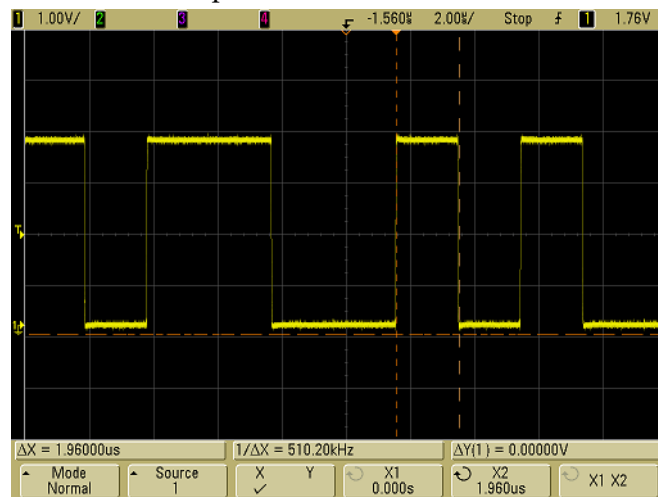

Figure 30 Measuring pulse width with cursors

4 Making Measurements

Press the **X1 X2** softkey and move the cursors together to check for pulse width variations in a pulse train.

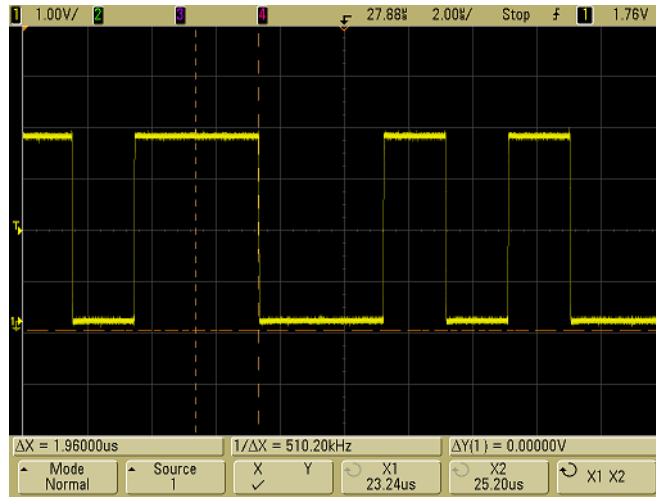

Figure 31 Moving the cursors together to check pulse width variations

Automatic Measurements

The following automatic measurements can be made in the **Quick Meas** menu.

Time Measurements

- Counter
- Duty Cycle
- Frequency
- Period
- Rise Time
- Fall Time
- + Width
- – Width
- X at Max
- X at Min

Phase and Delay

- Phase
- Delay

Voltage Measurements

- Average
- Amplitude
- Base
- Maximum
- Minimum
- Peak-to-Peak
- RMS
- Std Deviation
- Top

Preshoot and Overshoot

- Preshoot
- Overshoot

To make an automatic measurement

A brief description of how to make automatic measurements is given on [page 73](#).

Quick Meas makes automatic measurements on any channel source or any running math function. The results of the last four measurements selected are displayed on the dedicated line above the softkeys, or in the display area when some menus are selected. Quick Meas also makes measurements on stopped waveforms when you are panning and zooming.

Cursors are turned on to show the portion of the waveform being measured for the most recently selected measurement (right-most on the measurement line).

- 1 Press the **Quick Meas** key to display the automatic measurement menu.

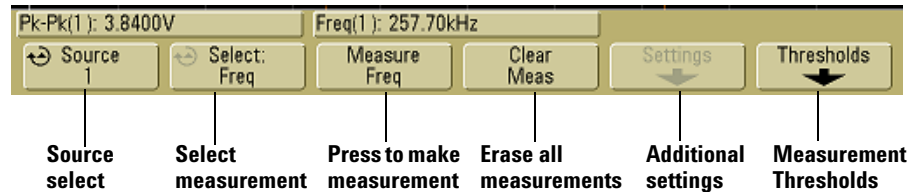

- 2 Press the **Source** softkey to select the channel or running math function on which the quick measurements will be made.

Only channels or math functions that are displayed are available for measurements. If you choose an invalid source channel for a measurement, the measurement will default to the nearest in the list that makes the source valid.

If a portion of the waveform required for a measurement is not displayed or does not display enough resolution to make the measurement, the result will display “No Edges”, “Clipped”, “Low Signal”, “< value”, or “> value”, or a similar message to indicate that the measurement may not be reliable.

- 3 Press the **Clear Meas** softkey to stop making measurements and to erase the measurement results from the display line above the softkeys.

When **Quick Meas** is pressed again, the default measurements will be Frequency and Peak-Peak.

- 4 Press the **Select** softkey then rotate the Entry knob to select a measurement to be made.
- 5 The **Settings** softkey will be available to make additional measurement settings on some measurements.
- 6 Press the **Measure** softkey to make the measurement.
- 7 To turn off **Quick Meas**, press the **Quick Meas** key again until it is not illuminated.

To set measurement thresholds

Setting measurement thresholds defines the vertical levels where measurements will be taken on an analog channel, or math waveform

Changing default thresholds may change measurement results

The default lower, middle, and upper threshold values are 10%, 50%, and 90% of the value between Top and Base. Changing these threshold definitions from the default values may change the returned measurement results for Average, Delay, Duty Cycle, Fall Time, Frequency, Overshoot, Period, Phase, Preshoot, Rise Time, RMS, +Width, and -Width.

- 1 Press the **Thresholds** softkey in the **Quick Meas** menu to set oscilloscope channel measurement thresholds.
- 2 Press the **Source** softkey to select the oscilloscope channel source for which you want to change measurement

thresholds. Each oscilloscope channel can be assigned unique threshold values.

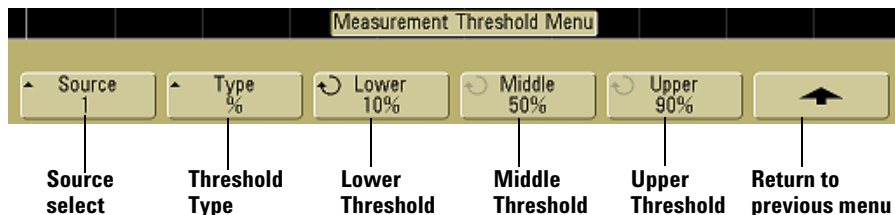

- 3 Press the **Type** softkey to set the measurement threshold to % (percentage of Top and Base value) or to **Absolute** (absolute value.)
 - Percentage thresholds can be set from 5% to 95%.
 - The units for absolute threshold for each channel is set in the channel probe menu.
 - When the **Source** is set to **Math**, the threshold **Type** can only be set to **Percent**.

Absolute threshold hints

- Absolute thresholds are dependent on channel scaling, probe attenuation, and probe units. Always set these values first before setting absolute thresholds.
- The minimum and maximum threshold values are limited to on-screen values.
- If any of the absolute threshold values are above or below the minimum or maximum waveform values, the measurement may not be valid.

- 4 Press the **Lower** softkey, then turn the Entry knob to set the lower measurement threshold value.

Increasing the lower value beyond the set middle value will automatically increase the middle value to be more than the lower value. The default lower threshold is 10% or 800 mV.

If threshold **Type** is set to %, the lower threshold value can be set from 5% to 93%.

- 5 Press the **Middle** softkey, then turn the Entry knob to set the middle measurement threshold value.

The middle value is bounded by the values set for lower and upper thresholds. The default middle threshold is 50% or 1.20 V.

- If threshold **Type** is set to %, the middle threshold value can be set from 6% to 94%.

6 Press the **Upper** softkey, then turn the Entry knob to set the upper measurement threshold value.

Decreasing the upper value below the set middle value will automatically decrease the middle value to be less than the upper value. The default upper threshold is 90% or 1.50 V.

- If threshold **Type** is set to %, the upper threshold value can be set from 7% to 95%.

Time Measurements

FFT measurements

When you make an **X at Max** or **X at Min** measurement on a math FFT function, the resultant units will be in Hertz. No other time related automatic measurement can be made on the FFT math function. Use the cursors to make other measurements on FFT.

The default lower, middle, and upper measurement thresholds are 10%, 50%, and 90% between Top and Base values. See [“To set measurement thresholds”](#) on page 184 for other percentage threshold and absolute value threshold settings.

The following figure shows time measurement points.

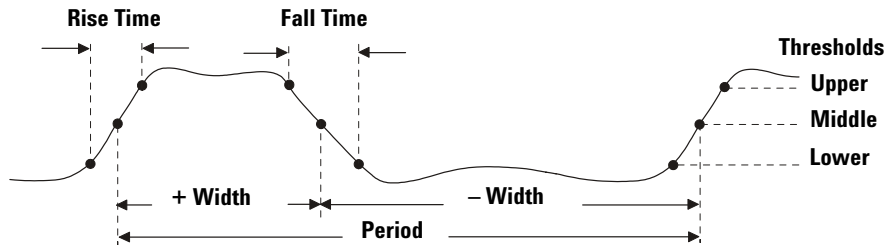

Counter

The InfiniiVision 5000 Series oscilloscopes have an integrated 5-digit hardware frequency counter which counts the number of cycles that occur within a period of time (known as the *gate time*) to measure the frequency of a signal.

The gate time for the Counter measurement is automatically adjusted to be 100 ms or twice the current time window, whichever is longer, up to 1 second.

The Counter can measure frequencies up to the bandwidth of the oscilloscope. The minimum frequency supported is $1/(2 \times \text{gate time})$.

The hardware counter uses the trigger comparator output. Therefore, the counted channel's trigger level must be set correctly. The Y cursor shows the threshold level used in the measurement.

Any channel except Math can be selected as the source.

Only one Counter measurement can be displayed at a time.

Duty Cycle

The duty cycle of a repetitive pulse train is the ratio of the positive pulse width to the period, expressed as a percentage. The X cursors show the time period being measured. The Y cursor shows the middle threshold point.

$$\text{Duty cycle} = \frac{\text{Width}}{\text{Period}} \times 100$$

Frequency

Frequency is defined as $1/\text{Period}$. Period is defined as the time between the middle threshold crossings of two consecutive, like-polarity edges. A middle threshold crossing must also travel through the lower and upper threshold levels which eliminates runt pulses. The X cursors show what portion of the waveform is being measured. The Y cursor shows the middle threshold point.

To isolate an event for frequency measurement The following figure shows how to use zoom sweep to isolate an event for a frequency measurement. If the measurement is not possible in the zoom mode, then the main time base is used. If the waveform is clipped, it may not be possible to make the measurement.

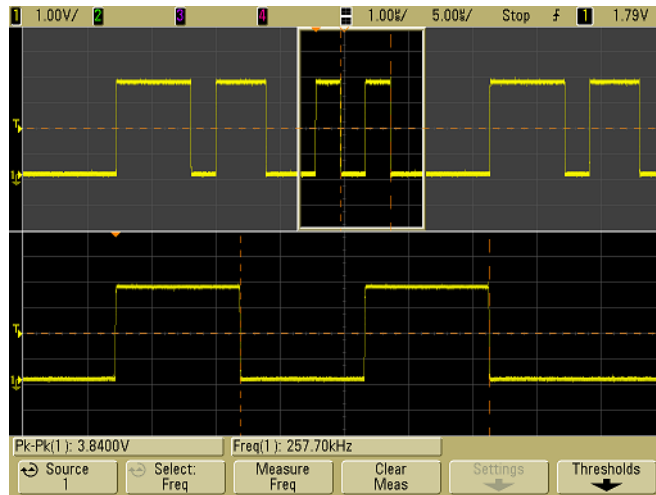

Figure 32 Isolating event for Frequency measurement

Period

Period is the time period of the complete waveform cycle. The time is measured between the middle threshold points of two consecutive, like-polarity edges. A middle threshold crossing must also travel through the lower and upper threshold levels which eliminates runt pulses. The X cursors show what portion of the waveform is being measured. The Y cursor shows the middle threshold point.

Fall Time

The fall time of a signal is the time difference between the crossing of the upper threshold and the crossing of the lower threshold for a negative-going edge. The X cursor shows the edge being measured. For maximum measurement accuracy, set

the sweep speed as fast as possible while leaving the complete falling edge of the waveform on the display. The Y cursors show the lower and upper threshold points.

Rise Time

The rise time of a signal is the time difference between the crossing of the lower threshold and the crossing of the upper threshold for a positive-going edge. The X cursor shows the edge being measured. For maximum measurement accuracy, set the sweep speed as fast as possible while leaving the complete rising edge of the waveform on the display. The Y cursors show the lower and upper threshold points.

+ Width

+ Width is the time from the middle threshold of the rising edge to the middle threshold of the next falling edge. The X cursors show the pulse being measured. The Y cursor shows the middle threshold point.

– Width

– Width is the time from the middle threshold of the falling edge to the middle threshold of the next rising edge. The X cursors show the pulse being measured. The Y cursor shows the middle threshold point.

X at Max

X at Max is the X axis value (usually time) at the first displayed occurrence of the waveform Maximum, starting from the left-side of the display. For periodic signals, the position of the maximum may vary throughout the waveform. The X cursor shows where the current X at Max value is being measured.

To measure the peak of an FFT:

- 1 Select **FFT** as the math function in the **Math** menu.
- 2 Choose **Math** as the source in the **Quick Meas** menu.
- 3 Choose **Maximum** and **X at Max** measurements.

Maximum units are in dB and **X at Max** units are in Hertz for FFT.

X at Min

X at Min is the X axis value (usually time) at the first displayed occurrence of the waveform Minimum, starting from the left-side of the display. For periodic signals, the position of the minimum may vary throughout the waveform. The X cursor shows where the current X at Min value is being measured.

Delay and Phase Measurements

Delay

Delay measures the time difference from the selected edge on source 1 and the selected edge on source 2 closest to the trigger reference point at the middle threshold points on the waveforms. Negative delay values indicate that the selected edge of source 1 occurred after the selected edge of source 2.

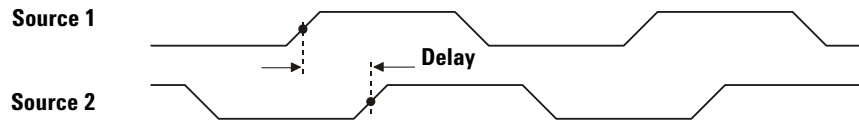

- 1 Press the **Quick Meas**→**Select** and select **Delay**. Press the **Settings** softkey to select the source channels and slope for the delay measurement.

The default Delay settings measure from the rising edge of channel 1 to the rising edge of channel 2.

- 2 Press the **Measure Delay** softkey to make the measurement.

The following example shows a delay measurement between the rising edge of channel 1 and the rising edge of channel 2.

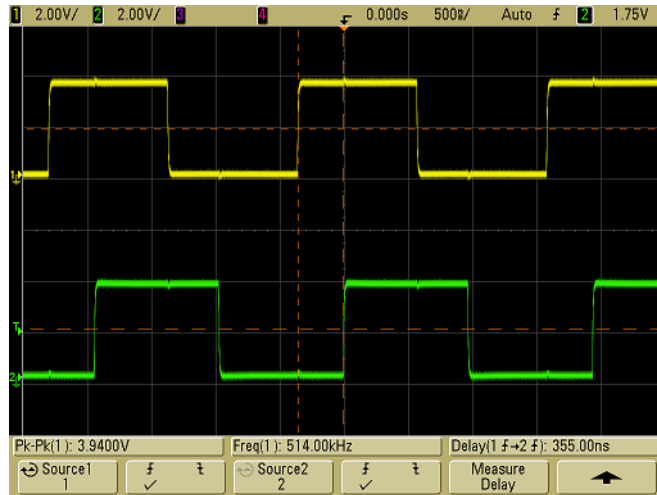
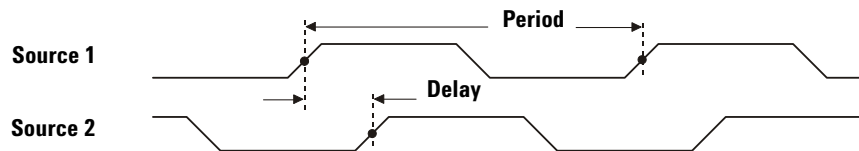

Figure 33 Delay Measurement

Phase

Phase is the calculated phase shift from source 1 to source 2, expressed in degrees. Negative phase shift values indicate that the rising edge of source 1 occurred after the rising edge of source 2.

$$\text{Phase} = \frac{\text{Delay}}{\text{Source 1 Period}} \times 360$$



4 Making Measurements

- 1 Press the **Settings** softkey to select the source 1 and source 2 channels for the phase measurement.

The default Phase settings measure from channel 1 to channel 2.

The example below shows a phase measurement between the channel 1 and the math d/dt function on channel 1.

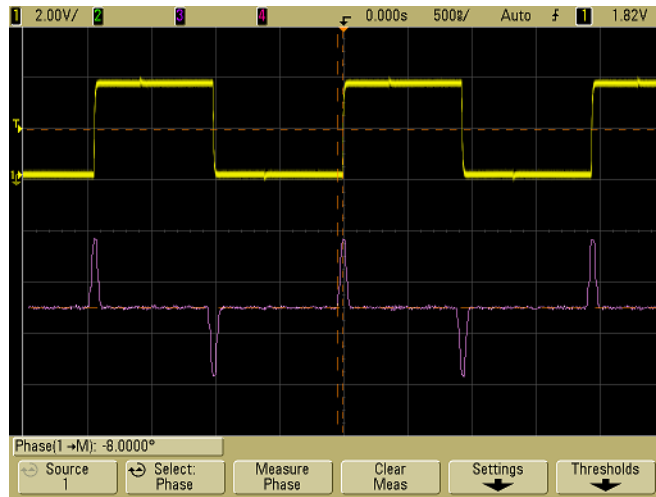

Figure 34 Phase Measurement

Voltage Measurements

Measurement units for each input channel can be set to Volts or Amps using the channel **Probe Units** softkey. A scale unit of **U** (undefined) will be displayed for math function 1-2 and for d/dt , and $\int dt$ when 1-2 or 1+2 is the selected source if channel 1 and channel 2 are set to dissimilar units in the channel **Probe Units** softkey.

Math Measurements and Units

Only Peak-Peak, Maximum, Minimum, Average, X at Min, and X at Max automatic measurements may be made on a math FFT function. See "Making time measurements automatically" for the FFT X at Max and X at Min measurement. Use the cursors to make other measurements on FFT. All voltage measurements may be made on other math functions. The resultant units are:

FFT:	dB* (decibels)
1 * 2:	V^2 , A^2 or W (Volt-Amp)
1 - 2:	V (Volts) or A (Amps)
d/dt :	V/s or A/s (V/second A/second)
$\int dt$:	Vs or As (V-seconds or A-seconds)

* When the FFT source is channel 1, 2, 3, or 4, FFT units will be displayed in dBV when channel units is set to Volts and channel impedance is set to 1 M Ω . FFT units will be displayed in dBm when channel units is set to Volts and channel impedance is set to 50 Ω . FFT units will be displayed as dB for all other FFT sources or when a source channel's units has been set to Amps.

The following figure shows the voltage measurement points.

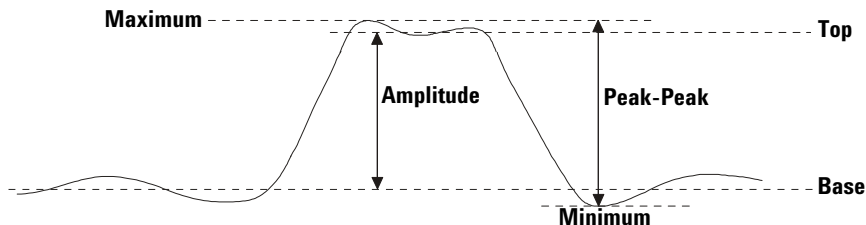

Amplitude

The Amplitude of a waveform is the difference between its Top and Base values. The Y cursors show the values being measured.

Average

Average is the sum of the waveform samples divided by the number of samples over one or more full periods. If less than one period is displayed, Average is calculated on the full width of the display. The X cursors show what portion of the displayed waveform is being measured.

$$\text{Average} = \frac{\sum x_i}{n} \quad \begin{array}{l} \text{where } x_i = \text{value at } i\text{th point being measured} \\ n = \text{number of points in measurement interval} \end{array}$$

Base

The Base of a waveform is the mode (most common value) of the lower part of the waveform, or if the mode is not well defined, the base is the same as Minimum. The Y cursor shows the value being measured.

Maximum

Maximum is the highest value in the waveform display. The Y cursor shows the value being measured.

Minimum

Minimum is the lowest value in the waveform display. The Y cursor shows the value being measured.

Peak-Peak

The peak-to-peak value is the difference between Maximum and Minimum values. The Y cursors show the values being measured.

RMS

RMS (DC) is the root-mean-square value of the waveform over one or more full periods. If less than one period is displayed, RMS (DC) average is calculated on the full width of the display. The X cursors show what interval of the waveform is being measured.

$$\text{RMS (dc)} = \sqrt{\frac{\sum_{i=1}^n x_i^2}{n}}$$

where x_i = value at i th point being measured
 n = number of points in measurement interval

Std Deviation

The Std Deviation measurement shows the standard deviation of the displayed voltage values. It is an RMS measurement across the full screen with the DC component removed. It is useful, for example, for measuring power supply noise.

The standard deviation of a measurement is the amount that a measurement varies from the mean value. The Mean value of a measurement is the statistical average of the measurement.

The following figure graphically shows the mean and standard deviation. Standard deviation is represented by the Greek letter sigma: σ . For a Gaussian distribution, two sigma ($\pm 1\sigma$) from the mean, is where 68.3 percent of the measurement results reside. Six sigma ($\pm 3\sigma$) from is where 99.7 percent of the measurement results reside.

4 Making Measurements

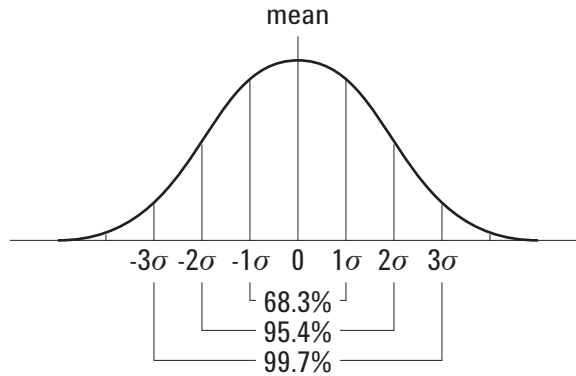

The mean is calculated as follows:

$$\bar{x} = \frac{\sum_{i=1}^N x_i}{N}$$

where:

\bar{x} = the mean.

N = the number of measurements taken.

x_i = the i^{th} measurement result.

The standard deviation is calculated as follows:

$$\sigma = \sqrt{\frac{\sum_{i=1}^N (x_i - \bar{x})^2}{N - 1}}$$

where:

σ = the standard deviation.

N = the number of measurements taken.

x_i = the i^{th} measurement result.

\bar{x} = the mean.

Top

The Top of a waveform is the mode (most common value) of the upper part of the waveform, or if the mode is not well defined, the top is the same as Maximum. The Y cursor shows the value being measured.

To isolate a pulse for Top measurement The following figure shows how to use zoom to isolate a pulse for a **Top** measurement.

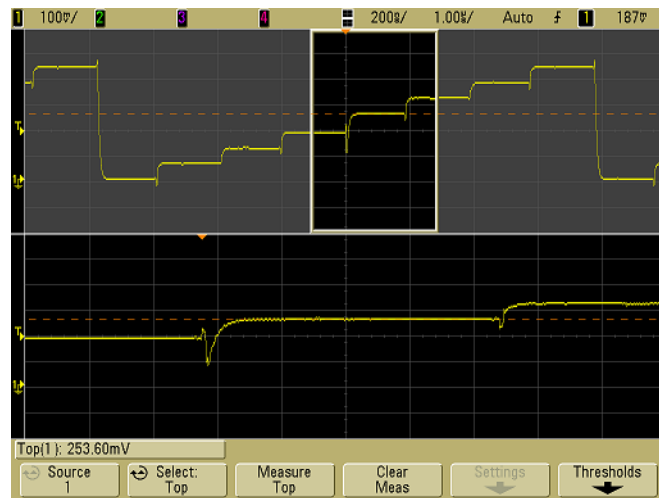

Figure 35 Isolating area for Top measurement

Overshoot and Preshoot Measurements

Preshoot

Preshoot is distortion that precedes a major edge transition expressed as a percentage of Amplitude. The X cursors show which edge is being measured (edge closest to the trigger reference point).

$$\text{Rising edge preshoot} = \frac{\text{Base} - \text{D local Minimum}}{\text{Amplitude}} \times 100$$

$$\text{Falling edge preshoot} = \frac{\text{local Maximum} - \text{D Top}}{\text{Amplitude}} \times 100$$

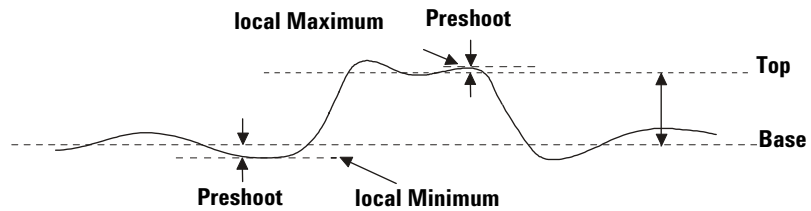

Overshoot

Overshoot is distortion that follows a major edge transition expressed as a percentage of Amplitude. The X cursors show which edge is being measured (edge closest to the trigger reference point).

$$\text{Rising edge overshoot} = \frac{\text{local Maximum} - \text{D Top}}{\text{Amplitude}} \times 100$$

$$\text{Falling edge overshoot} = \frac{\text{Base} - \text{D local Minimum}}{\text{Amplitude}} \times 100$$

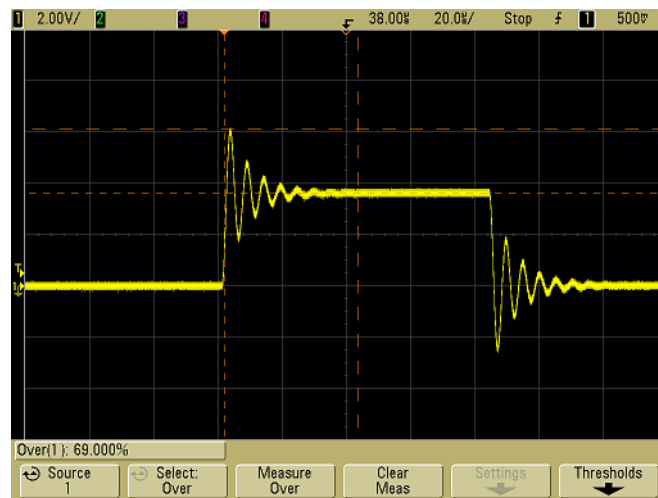
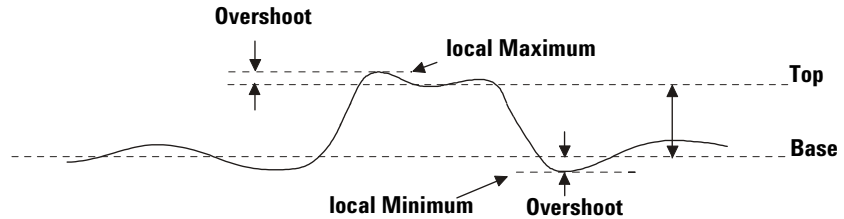

Figure 36 Automatic Overshoot measurement

4 Making Measurements



5 Displaying Data

- Pan and Zoom [202](#)
- Antialiasing [204](#)
- Using the XGA video output [204](#)
- Display Settings [205](#)
- Varying the intensity to view signal detail [208](#)
- Acquisition Modes [209](#)
- Using Serial Decode [216](#)
 - To decode I2C data [217](#)
 - To decode SPI data [221](#)
 - To decode CAN data [226](#)
 - To decode LIN data [233](#)
 - To decode UART/RS232 data [239](#)
 - To reduce the random noise on a signal [246](#)
 - To capture glitches or narrow pulses with peak detect and infinite persistence [248](#)
- How AutoScale Works [251](#)



Pan and Zoom

The ability to pan (move horizontally) and zoom (expand or compress horizontally) an acquired waveform is important because of the additional insight it can reveal about the captured waveform. This additional insight is often gained from seeing the waveform at different levels of abstraction. You may want to view both the big picture and the specific little picture details.

The ability to examine waveform detail after the waveform has been acquired is a benefit generally associated with digital oscilloscopes. Often this is simply the ability to freeze the display for the purpose of measuring with cursors or printing the screen. Some digital oscilloscopes go one step further by including the ability to further examine the signal details after acquiring them by panning and zooming through the waveform.

There is no limit imposed on the zoom ratio between the sweep speed used to acquire the data and the sweep speed used to view the data. There is, however, a useful limit. This useful limit is somewhat a function of the signal you are analyzing.

In normal display mode, with vectors (connect-the-dots) off, you can zoom in to the point where there are no samples on the screen. Obviously, this is far beyond the useful limit. Likewise, with vectors on, you can see the linear interpolation between the points, but again, this is of very limited value.

Zoom

The screen will still contain a relatively good display if you zoom in horizontally by a factor of 1000 and zoom in vertically by a factor of 10 to display the information from where it was acquired. Remember that you can only make automatic measurements on displayed data.

To pan and zoom a waveform

- 1 Press the **Run/Stop** key to stop acquisitions. The **Run/Stop** key is illuminated red when the oscilloscope is stopped.
- 2 Turn the sweep speed knob to zoom horizontally and turn the volts/division knob to zoom vertically.

The ∇ symbol at the top of the display indicates the time reference point where the zoom-in/zoom-out is referenced.

- 3 Turn the Horizontal Position knob ($\blacktriangleleft\blacktriangleright$) to pan horizontally and turn the channel's vertical position knob (\blacklozenge) to pan vertically.

The stopped display may contain several triggers worth of information, but only the last trigger acquisition is available for pan and zoom.

To set the waveform expansion reference point

When you change a channel's volts/division setting, the waveform display can be set to expand (or compress) about the signal ground level or the center of the display.

Expand About Ground The displayed waveform will expand about the position of the channel's ground. This is the default setting. The ground level of the signal is identified by the position of the ground level (\blacktriangleleft) icon at the far-left side of the display. The ground level will not move when you adjust the vertical sensitivity (volts/division) control.

If the ground level is off screen, the waveform will expand about the top or bottom edge of the screen based on where the ground is off screen.

Expand About Center The displayed waveform will expand about the center of the display.

To set the waveform expansion reference point

Press **Utility**→**Options**→**Preferences**→**Expand** and select **Ground** or **Center**.

Antialiasing

At slower sweep speeds, the sample rate is reduced and a proprietary display algorithm is used to minimize the likelihood of aliasing.

By default, Antialiasing is enabled. You should leave Antialiasing enabled unless there is a specific reason to switch it off.

If you need to switch Antialiasing off, press **Utilities**→**Options**→**Preferences** and press the **Antialiasing** softkey to switch the feature off. The displayed waveforms will be more susceptible to aliasing.

Using the XGA video output

A standard XGA video output connector is provided on the rear panel. You can connect a monitor to provide a larger display, or to provide a display at a viewing position away from the oscilloscope.

The oscilloscope's built-in display will remain on even when an external display is connected.

Display Settings

- Press the **Display** key to view the Display menu.

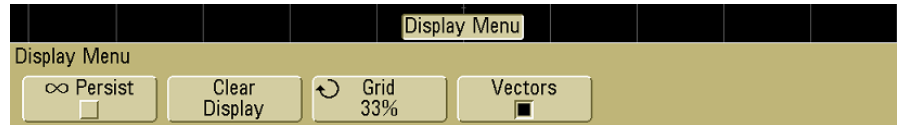

Infinite persistence

With infinite persistence, the oscilloscope updates the display with new acquisitions, but does not erase the results of previous acquisitions. All previous acquisitions are displayed in gray with reduced intensity. New acquisitions are shown in normal color with normal intensity. Waveform persistence is not kept beyond the display area boundary.

Use infinite persistence to measure noise and jitter, to see the worst-case extremes of varying waveforms, to look for timing violations, or to capture events that occur infrequently.

To use infinite persistence to display multiple repetitive events

- 1 Connect a signal to the oscilloscope.
- 2 Press the **Display** key, then press ∞ **Persist** to turn on infinite persistence. The display will begin accumulating multiple acquisitions. The accumulated waveforms are shown in gray with reduced intensity.
- 3 Press the **Clear Display** softkey to erase previous acquisitions. The oscilloscope will again start to accumulate acquisitions.
- 4 Turn off infinite persistence, then press the **Clear Display** key to return the oscilloscope to the normal display mode.

Accumulating multiple acquisitions

Turning off infinite persistence does not clear the display. This allows you to accumulate multiple acquisitions, stop acquisitions, and then compare future acquisitions to the stored waveforms.

Clearing stored infinite persistence waveforms

In addition to clearing the display by pressing the **Clear Display** softkey, the display is also cleared of previous acquisitions if you press the **AutoScale** key.

Grid intensity

To adjust the grid (graticule) intensity, press **Display→Grid** and use the Entry knob  to adjust the intensity.

Vectors (connect the dots)

The oscilloscopes are designed to operate optimally with vectors on. This mode gives the most realistic waveforms in most situations.

When enabled, **Vectors** draws a line between consecutive waveform data points.

- Vectors give an analog look to a digitized waveform.
- Vectors allow you to see steep edges on waveforms, such as square waves.
- Vectors allow subtle detail of complex waveforms to be viewed, much like an analog oscilloscope trace, even when the detail is just a small number of pixels in size.

The oscilloscope switches vectors on whenever the acquisition system stops.

Using Vectors (Display menu)

One of the most fundamental choices you must make about your display is whether to draw vectors (connect the dots) between the samples, or simply let the samples fill in the waveform. To some degree, this is a matter of personal preference, but it also depends on the waveform.

- You will probably operate the oscilloscope most often with vectors on. Complex analog signals like video and modulated signals show analog-like intensity information with vectors on.
- Turn vectors off when highly complex or multivalued waveforms are displayed. Turning vectors off may aid the display of multivalued waveforms such as eye diagrams.
- Having vectors on does not slow down the display rate.

Varying the intensity to view signal detail

The **Intensity** knob lets you adjust the plotted waveforms to account for various signal characteristics, such as fast sweep speeds and low trigger rates. Increasing the intensity lets you see the maximum amount of noise and infrequently occurring events. Reducing the intensity can expose more detail in complex signals as shown in the following figures.

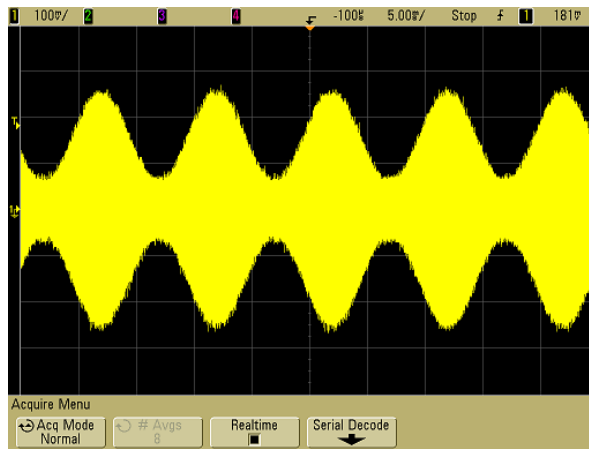

Figure 37 Amplitude Modulation with Noise Shown at 100% Intensity

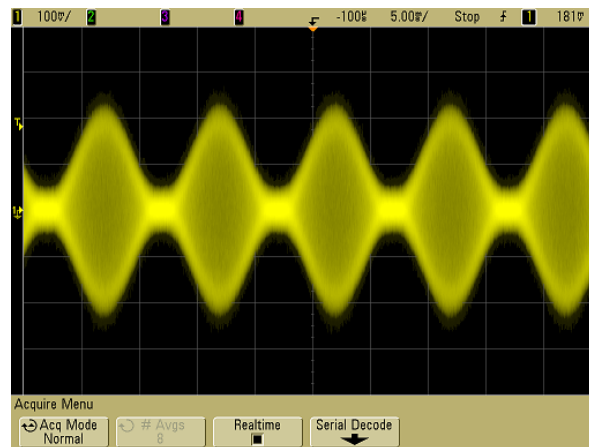

Figure 38 Amplitude Modulation with Noise Shown at 40% Intensity

Acquisition Modes

The InfiniiVision 5000 Series oscilloscopes have the following acquisition modes:

- **Normal** – for most waveforms (with normal decimating at slower sweep speeds, no averaging).
- **Peak Detect** – for displaying narrow pulses that occur infrequently (at slower sweep speeds).
- **Averaging** – for reducing noise and increasing resolution (at all sweep speeds, without bandwidth or rise time degradation).
- **High Resolution** – for reducing random noise (at slower sweep speeds).

Realtime sampling (where the oscilloscope produces the waveform display from samples collected during one trigger event) can be turned off or on in the Normal, Peak Detect, and High Resolution modes.

At Slower Sweep Speeds

At slower sweep speeds, the sample rate drops because the acquisition time increases and the oscilloscope's digitizer is sampling faster than it must to fill memory.

For example, suppose an oscilloscope's digitizer has a sample period of 1 ns (maximum sample rate of 1 GSa/s) and a 1 M memory depth. At that rate, memory is filled in 1 ms. If the acquisition time is 100 ms (10 ms/div), only 1 of every 100 samples is needed to fill memory.

Selecting the Acquisition mode

To select the acquisition mode press the Acquire key on the front panel.

Normal Mode

In Normal mode at slower sweep speeds, extra samples are decimated (in other words, some are thrown away). This mode yields the best display for most waveforms.

Peak Detect Mode

In Peak Detect mode at slower sweep speeds, minimum and maximum samples are kept in order to capture infrequent and narrow events (at the expense of exaggerating any noise). This mode displays all pulses that are at least as wide as the sample period (see [Table 9](#)).

Table 9 5000 Series Model Numbers and Sampling Rates

Bandwidth	100 MHz	300 MHz	500 MHz
Maximum Sample Rate	2 GSa/s	2 GSa/s	4 GSa/s
A sample is taken every (sample period)	500 ps	500 ps	250 ps
2-Channel DSO	DSO5012A	DSO5032A	DSO5052A
4-Channel DSO	DSO5014A	DSO5034A	DSO5054A

High Resolution Mode

In High Resolution mode, at slower sweep speeds extra samples are averaged in order to reduce random noise, produce a smoother trace on the screen, and effectively increase vertical resolution.

High Resolution mode averages sequential sample points within the same acquisition together. An extra bit of vertical resolution is produced for every factor of 4 averages. The number of extra bits of vertical resolution is dependent on the time per division setting (sweep speed) of the scope.

The slower the sweep speed, the greater the number of samples that are averaged together for each display point.

High Resolution mode is equivalent to the Averaging mode with #Averages=1; however, you can turn on Realtime sampling in the High Resolution mode.

High Resolution mode can be used on both single-shot and repetitive signals and it does not slow waveform update because the computation is done in the MegaZoom custom ASIC. High Resolution mode limits the scope's real-time bandwidth because it effectively acts like a low-pass filter.

Table 10 Sample Rate, Sweep Speed, and Bits of Resolution

2 GSa/s Sample Rate	4 GSa/s Sample Rate	Bits of resolution (# Avgs=1)
≤ 50 ns/div	≤ 50 ns/div	8
200 ns/div	100 ns/div	9
1 us/div	500 ns/div	10
5 us/div	2 us/div	11
≥ 20 us/div	≥ 10 us/div	12

Averaging Mode

The Averaging mode lets you average multiple acquisitions together to reduce noise and increase vertical resolution (at all sweep speeds). Averaging requires a stable trigger.

The number of averages can be set from 1 to 65536 in powers-of-2 increments.

A higher number of averages reduces noise more and increases vertical resolution.

Table 11 Number of Averages, Bits of Resolution

# Avgs	Bits of resolution
2	8
4	9
16	10
64	11
≥ 256	12

The higher the number of averages, the slower the displayed waveform responds to waveform changes. You must compromise between how quickly the waveform responds to changes and how much you want to reduce the displayed noise on the signal.

To use the Averaging mode

- 1 Press the **Acquire** key, then press the **Acq Mode** softkey until the Averaging mode is selected.
- 2 Press the **#Avgs** softkey and turn the Entry knob to set the number of averages that best eliminates the noise from the displayed waveform. The number of acquisitions being averaged is displayed in the **# Avgs** softkey.

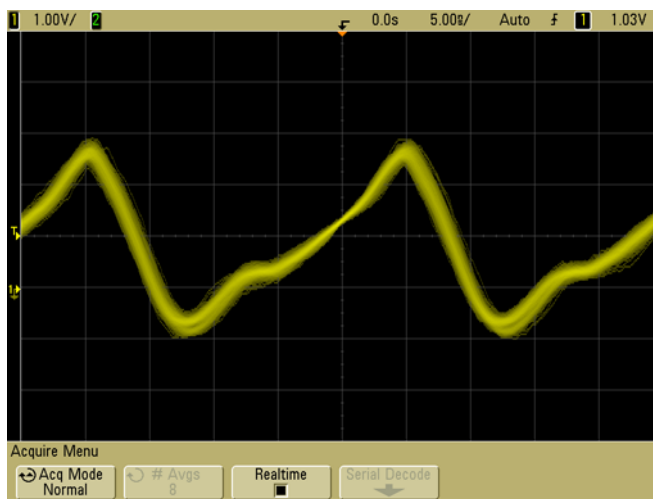

Figure 39 Random noise on the displayed waveform

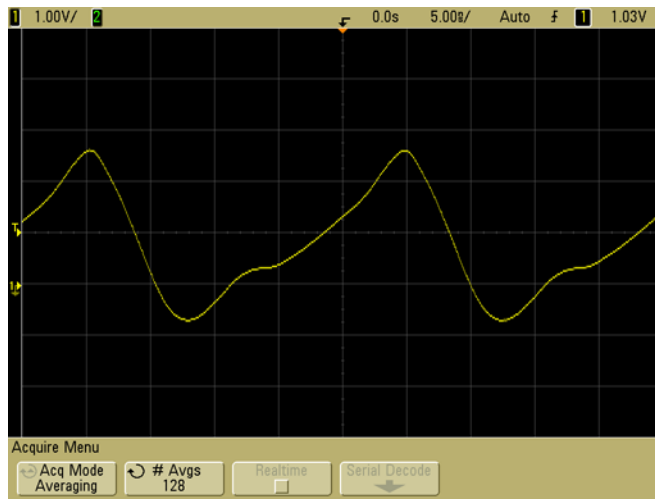

Figure 40 128 Averages used to reduce random noise

Realtime Sampling Option

Realtime sampling specifies that the oscilloscope produce the waveform display from samples collected during one trigger event (that is, one acquisition).

Use Realtime sampling to capture infrequent triggers, unstable triggers, or complex changing waveforms, such as eye diagrams.

Realtime sampling can be turned on in **Normal**, **Peak Detect**, or **High Resolution** acquisition modes. It cannot be turned on when the acquisition mode is **Averaging**.

When Realtime sampling is on (as in the default setup):

- When less than 1000 samples can be collected in the time spanned by the screen, a sophisticated reconstruction filter is used to fill in and enhance the waveform display.
- If you press the **Stop** key, and pan and zoom through the waveform using the Horizontal and Vertical controls, only the last trigger's acquisition will be displayed.

When Realtime sampling is off:

- The oscilloscope produces the waveform display from samples collected from multiple acquisitions. In this case, the reconstruction filter is not used.

Realtime Sampling and Oscilloscope Bandwidth

To accurately reproduce a sampled waveform, the sample rate should be at least four times the highest frequency component of the waveform. If not, it is possible for the reconstructed waveform to be distorted or aliased. Aliasing is most commonly seen as jitter on fast edges.

The maximum sample rate for 100 MHz and 300 MHz bandwidth oscilloscopes is 2 GSa/s.

The maximum sample rate for and 500 MHz bandwidth oscilloscopes is 4 GSa/s for a single channel in a channel pair. Channels 1 and 2 constitute a channel pair, and channels 3 and 4 constitute another channel pair. For example, the sample rate of a 4-channel oscilloscope is 4 GSa/s when channels 1 and 3, 1 and 4, 2 and 3, or 2 and 4 are on.

Whenever both channels in a channel pair are on, the sample rate for all channels is halved. For example, when channels 1, 2, and 3 are on, the sample rate for all channels is 2 GSa/s.

To see the sample rate, press the **Menu/Zoom** key on the front panel. The sample rate is displayed in the line just above the softkeys.

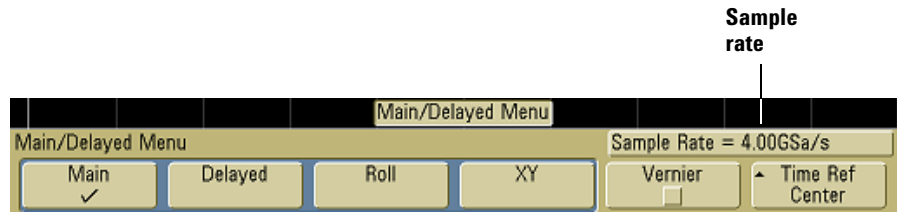

Using Serial Decode

Agilent's hardware accelerated serial decode options can be licensed on 4-channel or 4+16-channel 5000 Series oscilloscopes. The following serial decode licenses are available:

- The N5423A (Option LSS) license provides the ability to decode I²C (Inter-IC) and SPI (Serial Peripheral Interface) serial busses.
- The N5424A (Option AMS) license provides the ability to decode CAN (Controller Area Network) and LIN (Local Interconnect Network) serial busses.
- The N5457A (Option 232) license provides the ability to decode many UART (Universal Asynchronous Receiver/Transmitter) protocols including RS232 (Recommended Standard 232).

Adding the Automotive Serial (AMS) serial decode license will add more CAN and LIN trigger types to the trigger menu. See [page 108](#) or [page 118](#) for details.

To determine whether these licenses are installed on your oscilloscope press the **Utility** key, then press the **Options** softkey, the **Features** softkey, and the **Show license information** softkey.

To order serial decode licenses, contact your local Agilent Technologies representative (see www.agilent.com/find/contactus).

To decode I²C data

NOTE

Because of oscilloscope hardware resource limitations, you cannot decode I²C data while LIN triggering is selected.

NOTE

For I²C triggering setup see [page 112](#).

- 1 Select the I²C serial decode mode:
 - a Press the **Acquire** key.
 - b Press the **Serial Decode** softkey.

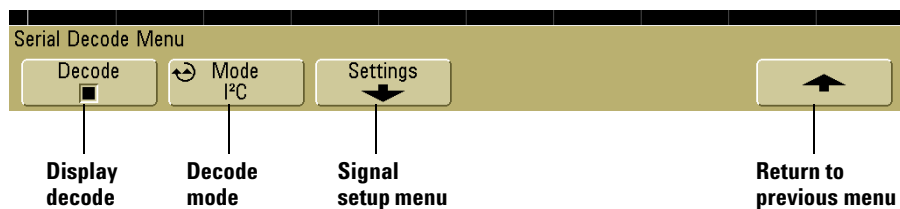

- c In the Serial Decode Menu, press the **Mode** softkey.
- d Use the Entry knob (or repeatedly press and release the **Mode** softkey) to select the **I²C** serial decode mode.

2 Specify the I²C signals:**NOTE**

If you have already set up an I²C trigger, the signals have already been specified, and you can continue on with [step 4](#).

Changing I²C signals in the Serial Decode setup also changes them in the Trigger setup.

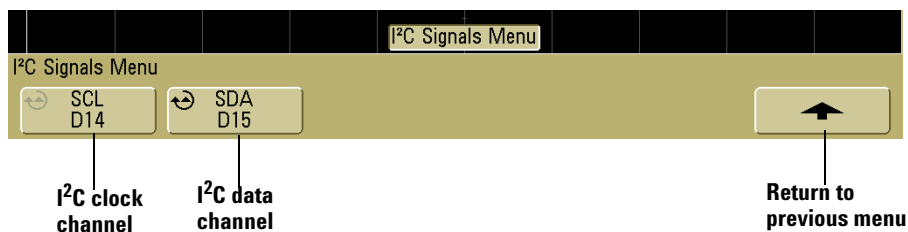
a Press the **Settings** softkey to access the I²C Signals Menu.b Press the **SCL** softkey, and use the Entry knob to select the channel probing the clock signal.c Press the **SDA** softkey, and use the Entry knob to select the channel probing the data signal.3 For the I²C signals, make sure the trigger or threshold levels are set to the middle of the signals:

- For analog channels, turn the Trigger Level knob.
- For digital channels, press the **D15-D0** key and the **Thresholds** softkey to access the threshold level setting softkeys.

4 If the decode line does not appear on the display, press the up-arrow softkey to return to the previous menu, then press the **Decode** softkey to turn it on.5 If the oscilloscope is stopped, press the **Run/Stop** key to acquire and decode data.

NOTE

If the setup does not produce a stable trigger, the I²C signal may be slow enough that the oscilloscope is AutoTriggering. Press the **Mode/Coupling** key, then press the **Mode** softkey to set the trigger mode from **Auto** to **Normal**.

You can use the **Zoom** horizontal sweep mode for easier navigation of the acquired data.

Interpreting Decoded I²C Data

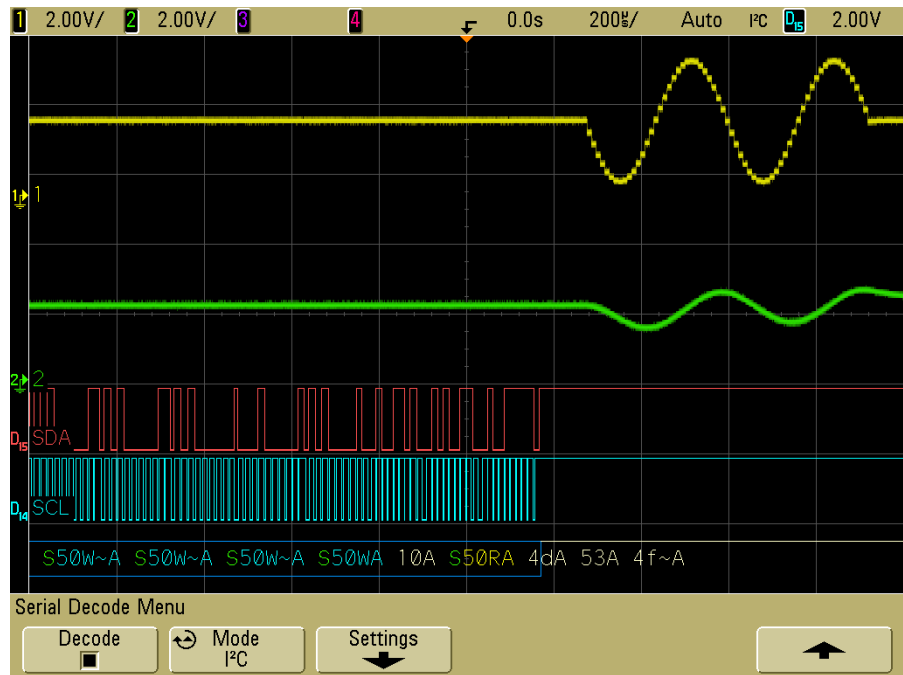

- White lines show an idle bus.
- Blue rectangles show an active bus (inside a packet/frame).
- In the decoded hexadecimal data:
 - Address values appear at the start of a frame.
 - Write addresses appear in light-blue along with the “W” character.
 - Read addresses appear in yellow along with the “R” character.
 - Restart addresses appear in green along with the “S” character.
 - Data values appear in white and may extend beyond the frame if an idle period follows.
 - “A” indicates Ack (low), “~A” indicates No Ack (high).
- Red dots in the decode line indicate that more data can be displayed. Scroll or expand the horizontal scale to view the data.
- Aliased bus values (undersampled or indeterminate) are drawn in red.
- Unknown bus values (undefined or error conditions) are drawn in red.

To decode SPI data

NOTE

Because of oscilloscope hardware resource limitations, you cannot decode SPI data while CAN or LIN triggering is selected.

NOTE

For SPI triggering setup see [page 121](#).

- 1 Select the SPI serial decode mode:
 - a Press the **Acquire** key.
 - b Press the **Serial Decode** softkey.

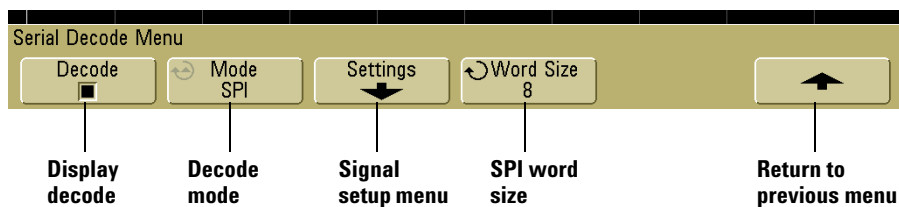

- c In the Serial Decode Menu, press the **Mode** softkey.
 - d Use the Entry knob (or repeatedly press and release the **Mode** softkey) to select the **SPI** serial decode mode.

2 Specify the SPI signals:

NOTE

If you have already set up an SPI trigger, the signals and their trigger or threshold levels have already been specified, and you can continue on with [step 4](#).

Changing SPI signals in the Serial Decode setup also changes them in the Trigger setup.

- a Press the **Settings** softkey to access the SPI Signals Menu.

Graphic showing SPI signals setup

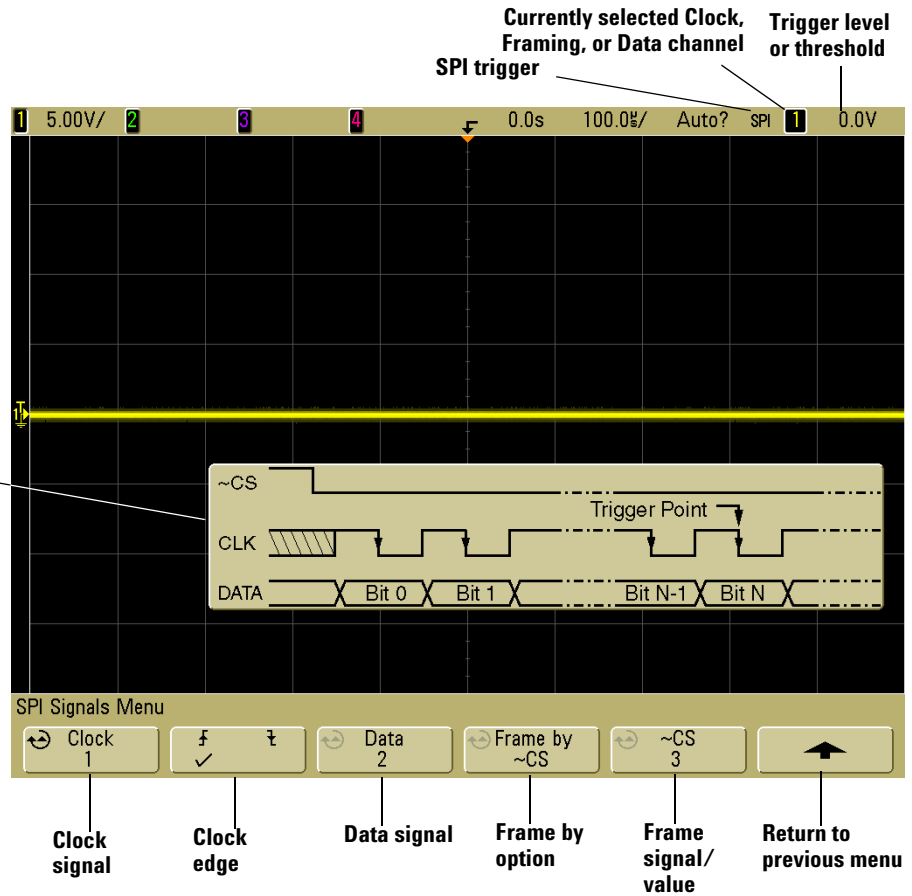

- b** Press the **Clock** softkey, and use the Entry knob to select the channel probing the clock signal.
 - c** Press the rising or falling edge softkey to specify the edge that the clock occurs on.
 - d** Press the **Data** softkey, and use the Entry knob to select the channel probing the data signal.
 - e** Repeatedly press and release the **Frame by** softkey to select the method used to identify frames:
 - **~CS - Not Chip Select** – an active low chip select signal.
 - **CS - Chip Select** – an active high chip select signal.
 - **Clock Timeout** – clock idle for a period of time.
 - f** If you chose framing by chip select or not chip select, press the **CS** or **~CS** softkey, and use the Entry knob to select the channel probing the chip select signal.

If you chose framing by clock timeout, press the **Timeout** softkey, and use the Entry knob to specify the idle time.
- 3** For the SPI signals, make sure the trigger or threshold levels are set to the middle of the signals:
 - For analog channels, turn the Trigger Level knob.
 - For digital channels, press the **D15-D0** key and the **Thresholds** softkey to access the threshold level setting softkeys.
 - 4** Press the up-arrow softkey to return to the previous menu. Press the **Word Size** softkey, and use the Entry knob to select the number of bits in a word.
 - 5** If the decode line does not appear on the display, press the **Decode** softkey to turn it on.
 - 6** If the oscilloscope is stopped, press the **Run/Stop** key to acquire and decode data.

NOTE

If the setup does not produce a stable trigger, the CAN signal may be slow enough that the oscilloscope is AutoTriggering. Press the **Mode/Coupling** key, then press the **Mode** softkey to set the trigger mode from **Auto** to **Normal**.

You can use the **Zoom** horizontal sweep mode for easier navigation of the acquired data.

Interpreting Decoded SPI Data

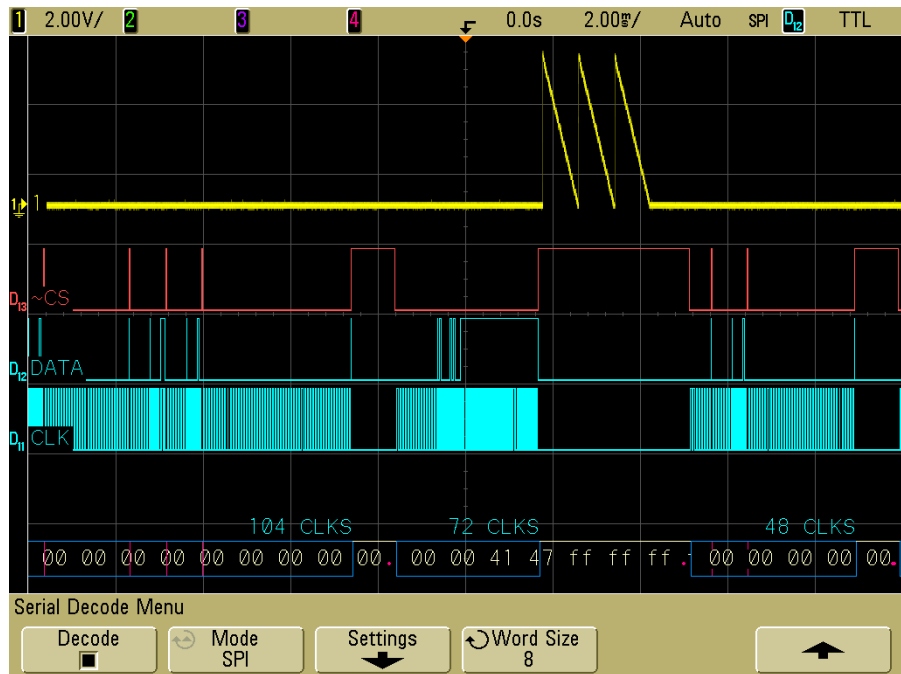

- White lines show an idle bus.
- Blue rectangles show an active bus (inside a packet/frame).
- The number of clocks in a frame appears in light-blue above the frame, to the right.
- Decoded hexadecimal data values appear in white and may extend beyond the frame if an idle period follows.
- Red dots in the decode line indicate that there is data that is not being displayed. Scroll or expand the horizontal scale to view the information.

- Aliased bus values (undersampled or indeterminate) are drawn in red.
- Unknown bus values (undefined or error conditions) are drawn in red.

To decode CAN data

NOTE

For CAN triggering setup see [page 108](#).

- 1 Connect the CAN signal to one of the oscilloscope's input channels.
- 2 Set up the trigger mode as described in “[Triggering the Oscilloscope](#)” on page 89. You can use CAN trigger or another trigger type.
- 3 Select the CAN serial decode mode:
 - a Press the **Acquire** key.
 - b Press the **Serial Decode** softkey.

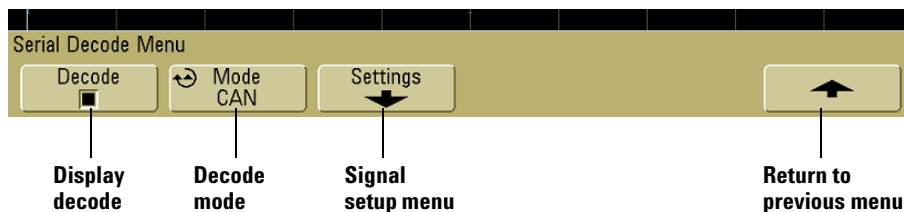

- c In the Serial Decode Menu, press the **Mode** softkey.
- d Use the Entry knob (or repeatedly press and release the **Mode** softkey) to select the **CAN** serial decode mode.

- 4 Specify the CAN signal:
 - a Press the **Settings** softkey to access the CAN Signals Menu.

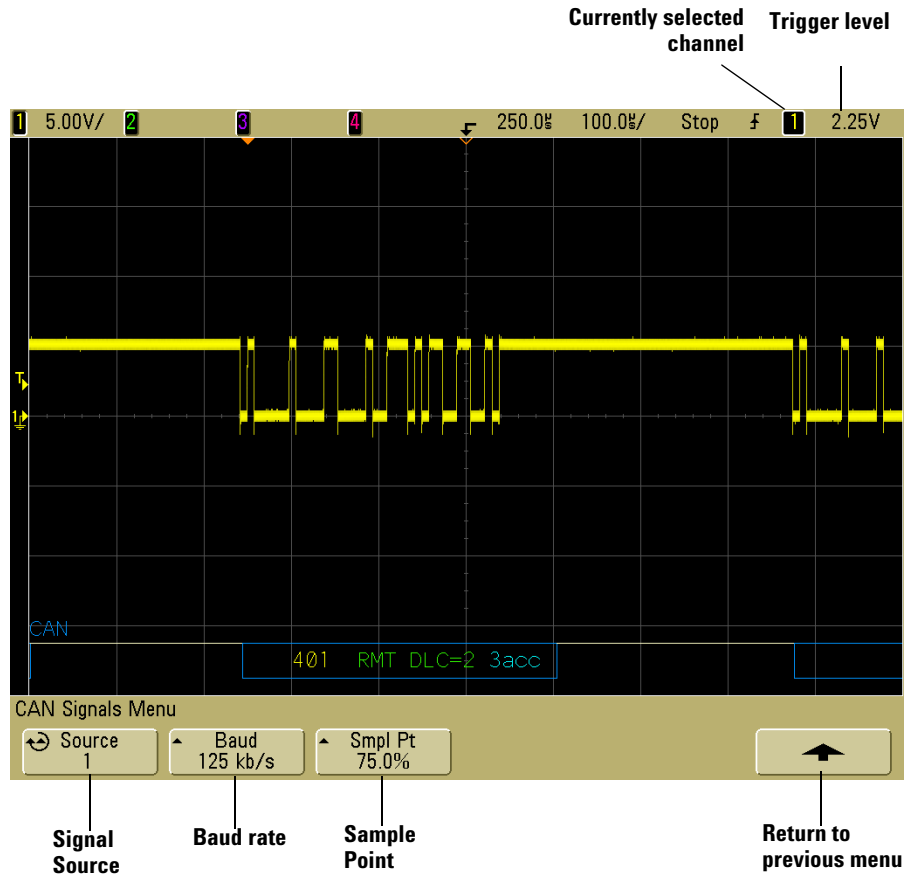

- 5 Press the **Source** softkey, and use the Entry knob to select the channel for the CAN signal. Make sure the trigger or threshold levels are set to the middle of the CAN signal.
- 6 Repeatedly press and release the **Baud** softkey to specify the CAN signal baud rate.
- 7 Repeatedly press and release the **Smpl Pt** softkey to select the point between phase segments 1 and 2 where the state of the

bus is measured. This controls the point within the bit's time where the bit value is captured.

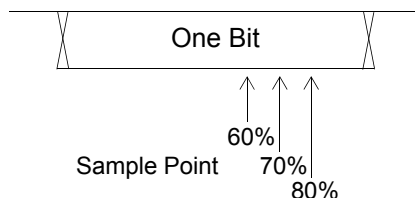

8 Set the trigger level.

- For analog channels, turn the Trigger Level knob.
- For digital channels, press the **D15-D0** key and the **Thresholds** softkey to access the threshold level setting softkeys.

NOTE

Changing the Source settings in the Serial Decode setup also changes them in the Trigger setup.

9 Return to the previous menu by pressing the up-arrow softkey.

10 If the decode line does not appear on the display, press the **Decode** softkey to turn it on.

11 If the oscilloscope is stopped, press the **Run/Stop** key to acquire and decode data.

NOTE

If the setup does not produce a stable trigger, the CAN signal may be slow enough that the oscilloscope is AutoTriggering. Press the **Mode/Coupling** key, then press the **Mode** softkey to set the trigger mode from **Auto** to **Normal**.

You can use the **Zoom** horizontal sweep mode for easier navigation of the decoded data.

Interpreting Decoded CAN Data

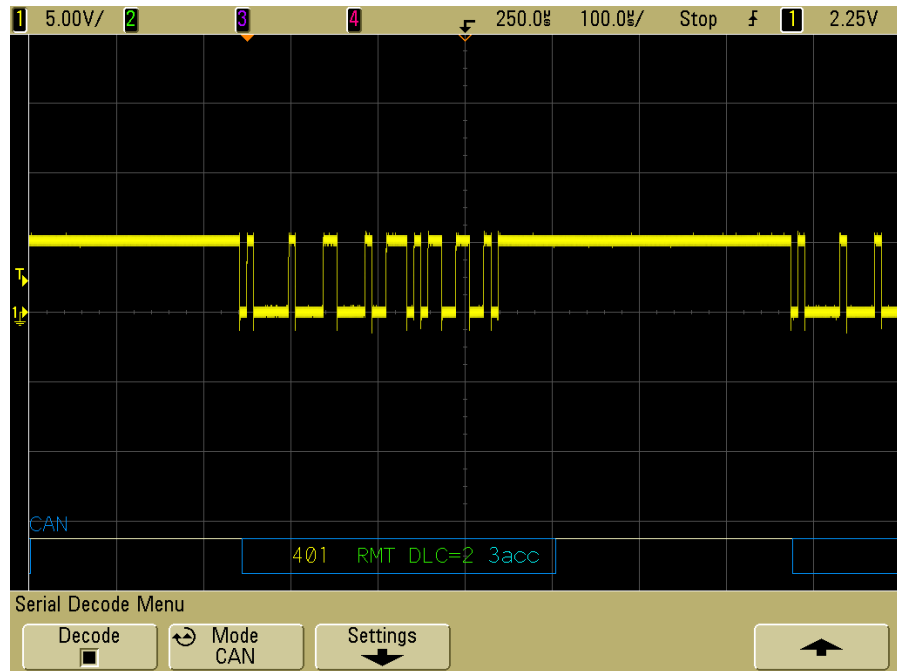

- Frame ID appears in hex digits in yellow. Frames of 11 or 29 bits are automatically detected.
- Remote frame (RMT) appears in green.
- Data length code (DLC) appears in blue.
- Data bytes appear in hex digits in white for data frames.
- Cyclic redundancy check (CRC) appears in hex digits in blue when valid, or in red to indicate that the oscilloscope's hardware decode calculated a CRC that is different from the incoming CRC data stream.
- White lines show an idle bus.
- Blue rectangles show an active bus (inside a packet/frame).
- Decoded hexadecimal data values may extend beyond the frame if the timebase setting is too slow.

5 Displaying Data

- Red dots in the decode line indicate that there is data that is not being displayed. Scroll or expand the horizontal scale to view the information.
- Aliased bus values (undersampled or indeterminate) are drawn in red.
- Unknown bus values (undefined or error conditions) are drawn in red with a “?” label.
- Flagged error frames are drawn in red with an “ERR” label.

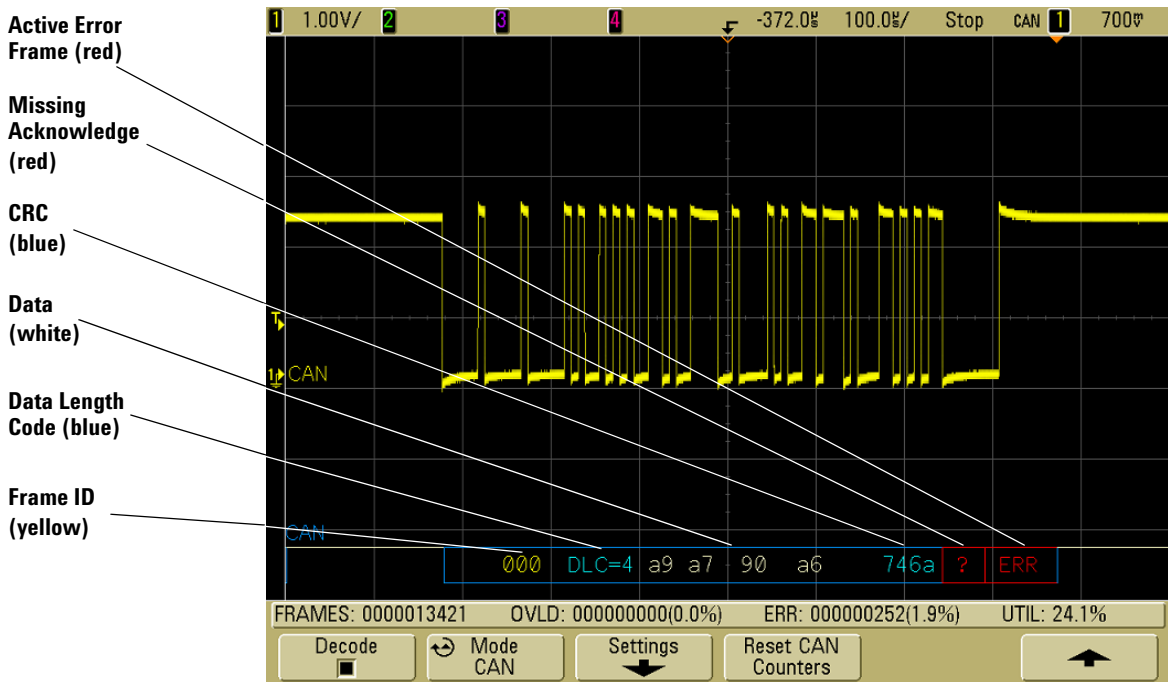

CAN Totalizer

The CAN totalizer provides a direct measure of bus quality and efficiency. The CAN totalizer measures total CAN frames, flagged error frames, overload frames, and bus utilization.

The totalizer is always running (counting frames and calculating percentages) and is displayed whenever CAN decode is displayed. The totalizer counts even when the oscilloscope is stopped (not acquiring data). Pressing the **Run/Stop** key does not affect the totalizer. When an overflow condition occurs, the counter displays **OVERFLOW**. The counters can be reset to zero by pressing the **Reset CAN Counters** softkey.

Types of Frames

- *Active error frames* are CAN frames in which a CAN node recognizes an error condition during a data or remote frame and issues an active error flag.
- A *partial frame* occurs when the oscilloscope detects any error condition during a frame that is not followed by an active error flag. Partial frames are not counted.

Counters

- The **FRAMES** counter gives the total number of completed remote, data, overload, and active error frames.
- The **OVLD** counter gives the total number of completed overload frames and their percentage of the total number of frames.
- The **ERR** counter gives the total number of completed active error frames and their percentage of the total number of frames.
- The **UTIL** (bus load) indicator measures the percentage of time the bus is active. The calculation is done on 330 ms periods, approximately every 400 ms.

Example: If a data frame contains an active error flag, both the **FRAMES** counter and the **ERR** counter will be incremented. If a data frame contains an error that is not an active error it is considered a partial frame and no counters are incremented.

5 Displaying Data

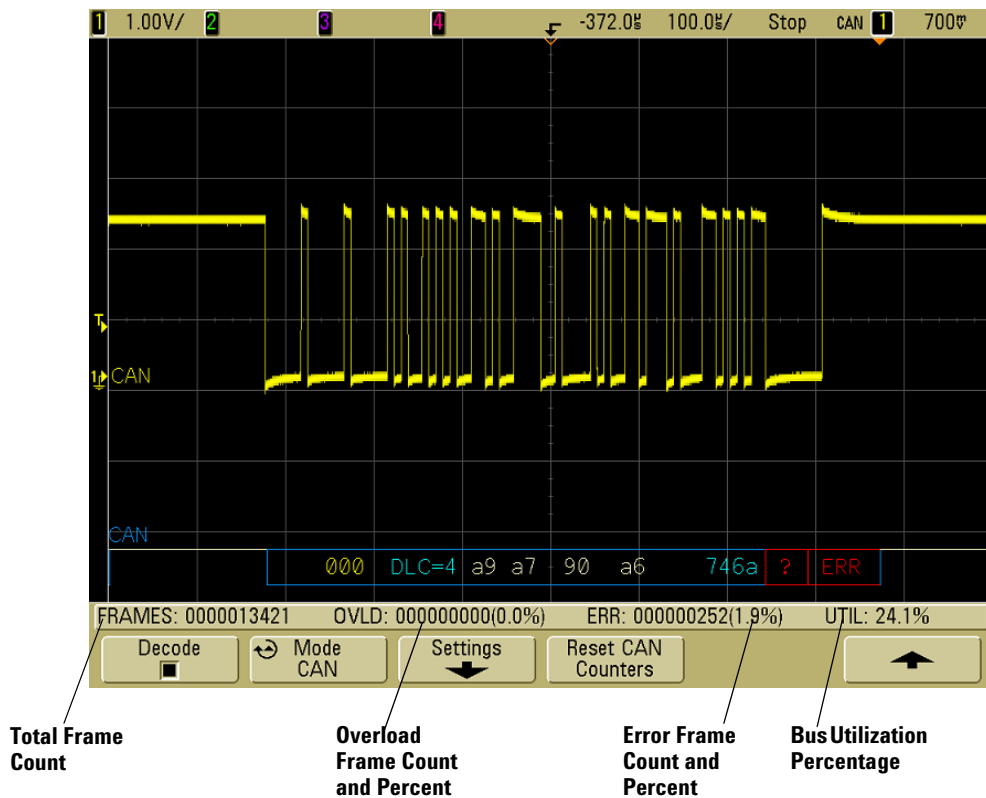

To decode LIN data

NOTE

For LIN triggering setup see [page 118](#).

- 1 Select the LIN serial decode mode:
 - a Press the **Acquire** key.
 - b Press the **Serial Decode** softkey.

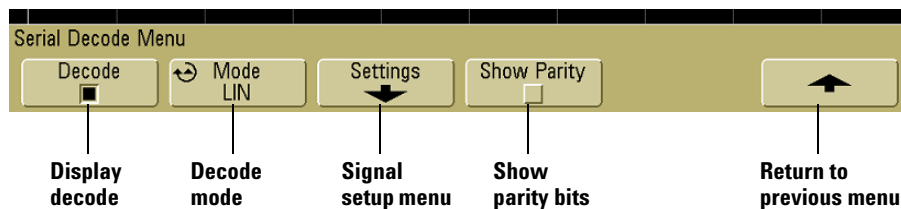

- c In the Serial Decode Menu, press the **Mode** softkey.
 - d Use the Entry knob (or repeatedly press and release the **Mode** softkey) to select the **LIN** serial decode mode.
- 2 Choose whether to include the parity bits in the identifier field.
 - a If you want to mask the upper two parity bits, ensure that the box under the **Show Parity** softkey is not selected.
 - b If you want to include the parity bits in the identifier field, ensure that the box under the **Show Parity** softkey is selected.

3 Specify the LIN signal:

- a Press the **Settings** softkey to access the LIN Signals Menu.

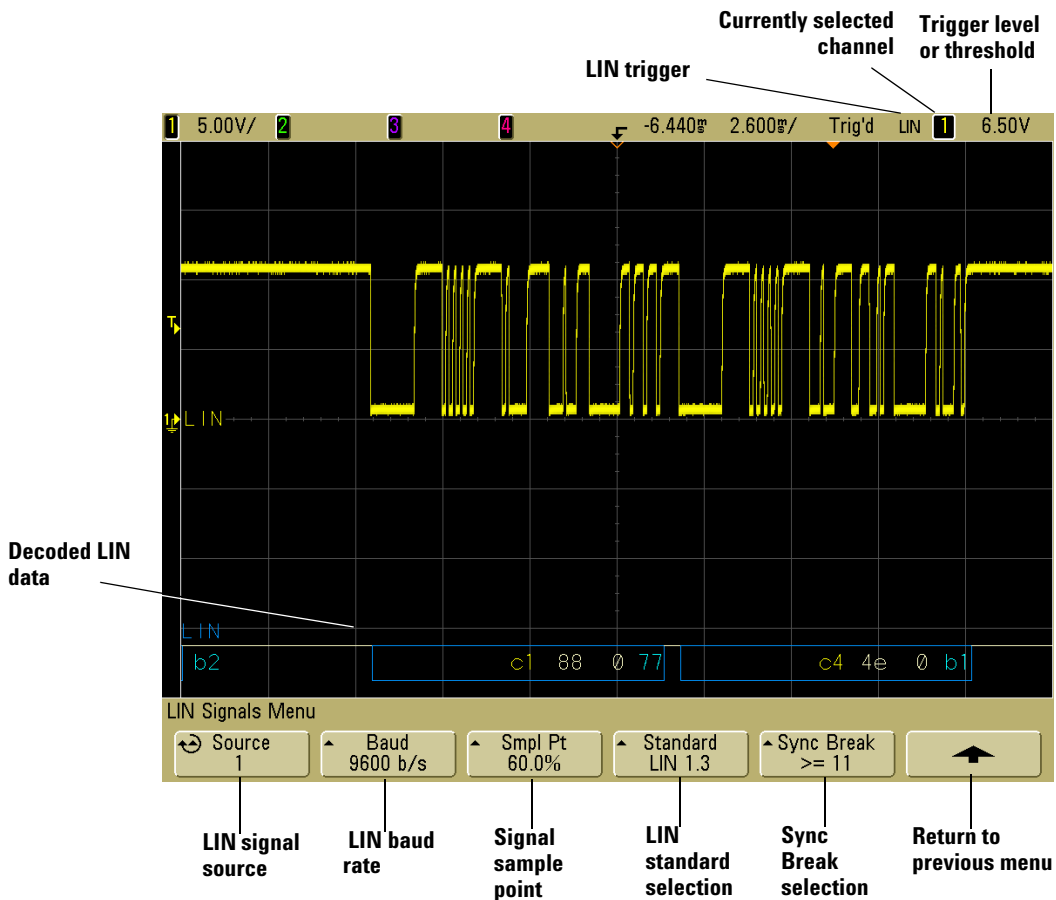

- b** Press the **Source** softkey, and use the Entry knob to select the channel probing the LIN signal.
- c** Repeatedly press and release the **Baud** softkey to specify the LIN signal baud rate.
- d** Repeatedly press and release the **Smpl Pt** softkey to select the sample point. This controls the point within the bit's time where the bit value is captured.

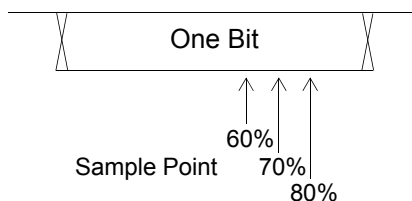

- e** Repeatedly press and release the **Standard** softkey to select the LIN standard (LIN 1.3 or LIN 2.0) of the measured signal. For LIN 1.2 signals, use the LIN 1.3 setting. The LIN 1.3 setting assumes the signal follows the “Table of Valid ID Values” as shown in section A.2 of the LIN Specification dated December 12, 2002. If your signal does not comply with the table, use the LIN 2.0 setting.
 - f** Repeatedly press and release the **Sync Break** softkey to define the minimum number of clocks that define a Sync Break.
- 4** Make sure the trigger or threshold levels are set to the middle of the LIN signal.
- For analog channels, turn the Trigger Level knob.
 - For digital channels, press the **D15-D0** key and the **Thresholds** softkey to access the threshold level setting softkeys.

NOTE

Changing the Trigger settings in the Serial Decode setup also changes them in the Trigger setup.

- g** If the decode line does not appear on the display, press the up-arrow softkey to return to the previous menu, then press the **Decode** softkey.
- 5** If the oscilloscope is stopped, press the **Run/Stop** key to acquire and decode data.

NOTE

If the setup does not produce a stable trigger, the LIN signal may be slow enough that the oscilloscope is AutoTriggering. Press the **Mode/Coupling** key, then press the **Mode** softkey to set the trigger mode from **Auto** to **Normal**.

You can use the **Zoom** horizontal sweep mode for easier navigation of the decoded data.

Interpreting Decoded LIN Data

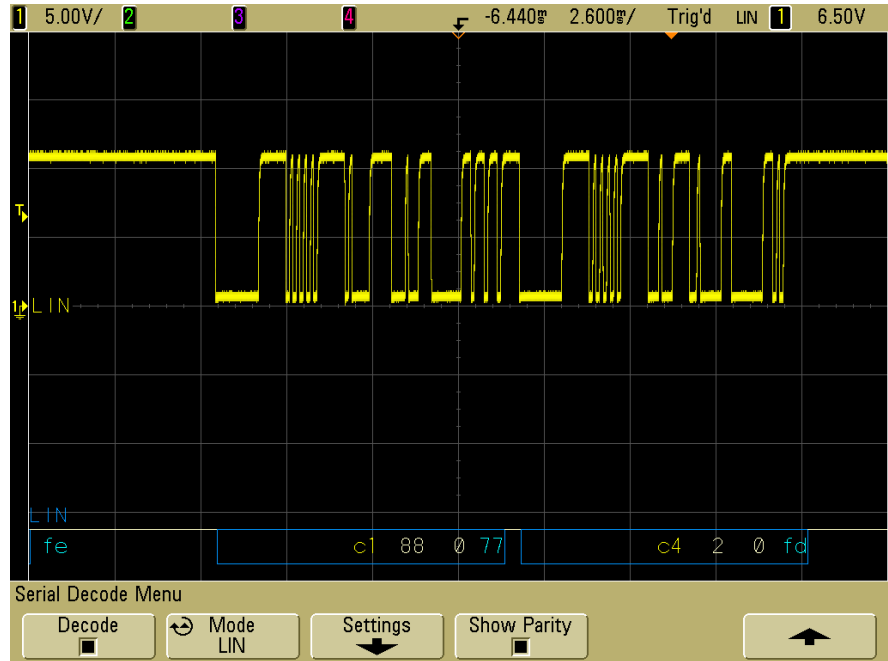

- White traces show an idle bus (LIN 1.3 only).
- Blue bi-level trace shows an active bus (inside a packet/frame).
- The hexadecimal ID and parity bits (if enabled) appear in yellow. If a parity error is detected the hexadecimal ID and parity bits (if enabled) appear in red.
- Decoded hexadecimal data values appear in white and may extend beyond the frame if an idle period follows.
- For LIN 1.3, the checksum appears in blue if correct, or red if incorrect. The checksum always appears in white for LIN 2.0.
- Red dots in the decode line indicate that there is data that is not being displayed. Scroll or expand the horizontal scale to view the information.
- Unknown bus values (undefined or error conditions) are drawn in red.
- If there is an error in the synch field, SYNC will appear in red.
- If the header exceeds the length specified in the standard, THM will appear red.
- If the total frame count exceeds the length specified in the standard, TFM will appear red (LIN 1.3 only).
- For LIN 1.3 a wakeup signal is indicated by WAKE in blue. If the wakeup signal is not followed by a valid wakeup delimiter a wakeup error is detected and displayed as WUP in red.

To decode UART/RS232 data

NOTE

Because of oscilloscope hardware resource limitations, you cannot decode UART/RS232 data while CAN, LIN, or FlexRay triggering is selected.

NOTE

For UART/RS232 triggering setup see [page 142](#).

- 1 Select the UART/RS232 serial decode mode:
 - a Press the **Acquire** key.
 - b Press the **Serial Decode** softkey.

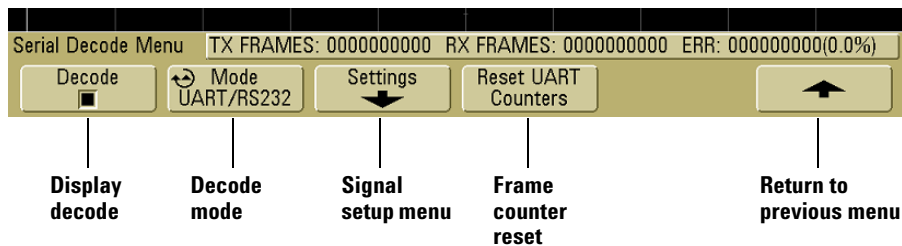

- c In the Serial Decode Menu, press the **Mode** softkey.
 - d Use the Entry knob (or repeatedly press and release the **Mode** softkey) to select the **UART/RS232** serial decode mode if it is not already selected.

NOTE

Changing UART/RS232 signals in the Serial Decode setup also changes them in the Trigger setup.

2 Specify the UART/RS232 signals:

- a Press the **Settings** softkey to access the UART/RS232 decode settings menu.

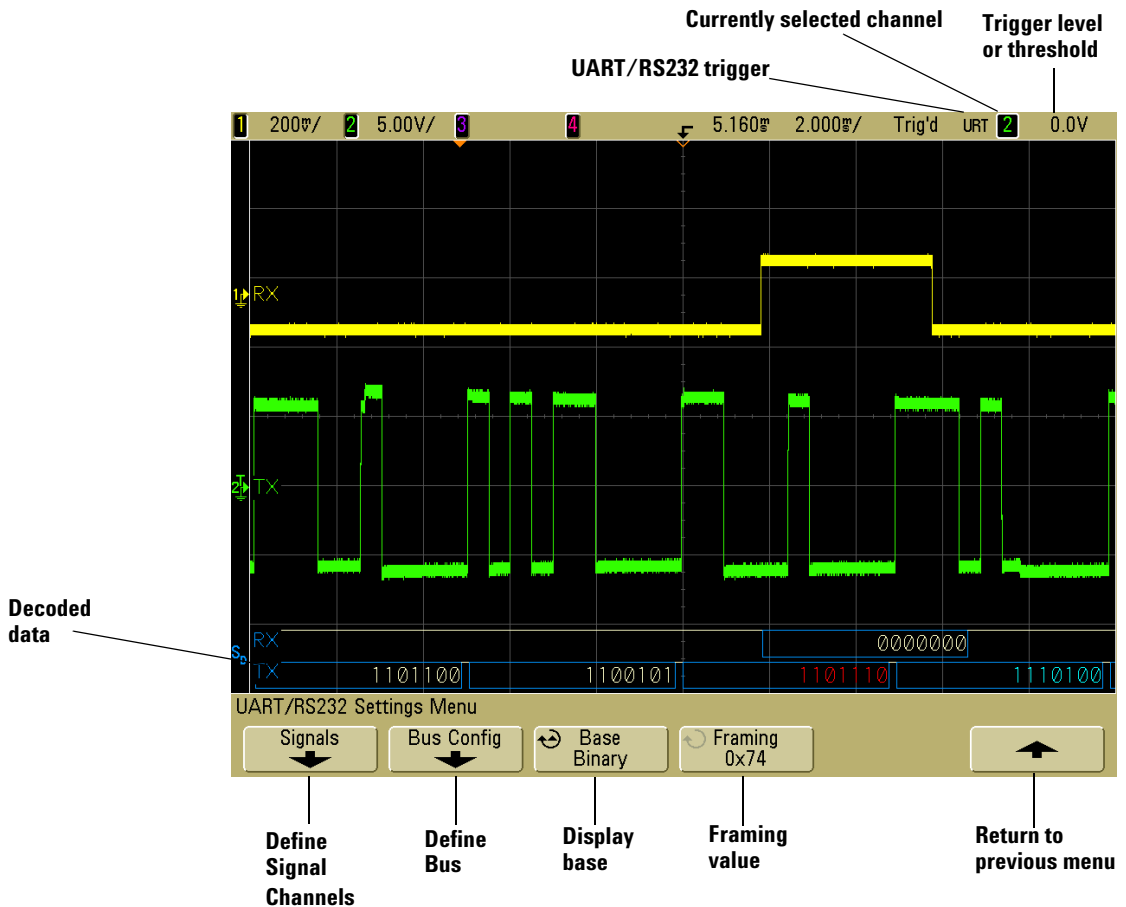

- b Press the **Signals** softkey, and select the oscilloscope channels that you have connected to the Rx and Tx signals.

See the UART/RS232 triggering section on page [page 142](#) for detailed instructions.

3 Press the Return to previous menu (up arrow) softkey.

NOTE

Changing the Bus Configuration settings in the Serial Decode setup also changes them in the Trigger setup.

4 Press the **Bus Config** softkey.

- a #Bits:** Set the number of bits in the UART/RS232 words to match your target system (selectable from 5-9 bits).
- b Parity:** Choose odd, even, or none, based on your target system.
- c Baud:** Select the baud rate to match the signal in your target system.
- d Polarity:** Select idle low or idle high to match your target system's state when at idle. For RS232 select idle low.
- e Bit Order:** Select whether the most significant bit (MSB) or the least significant bit (LSB) is presented after the start bit in the signal from your target system. For RS232 select LSB.

NOTE

In the decode display the most significant bit is always displayed on the left regardless of how Bit Order is set.

5 Press the Return to previous menu (up arrow) softkey.

6 Press the **Base** softkey to select the base (hex, binary, or ASCII) in which decoded words are displayed.

- When displaying words in ASCII, the 7-bit ASCII format is used. Valid ASCII characters are between 0x00 and 0x7F. To display in ASCII you must select at least 7 bits in the Bus Configuration. If ASCII is selected and the data exceeds 0x7F, the data is displayed in hex.
- When **#Bits** is set to 9, the 9th (alert) bit is displayed directly to the left of the ASCII value (which is derived from the lower 8 bits).

- 7** Optional: Press the **Framing** softkey and select a value. In the decode display the chosen value will be displayed in light blue. However, if a parity error occurs the data will be displayed in red.
- 8** Make sure the trigger or threshold levels are set to the middle of the signals:
 - For analog channels, turn the Trigger Level knob.
 - For digital channels, press the **D15-D0** key and the **Thresholds** softkey to access the threshold level setting softkeys.
- 9** If the decode line does not appear on the display, press the up arrow key to return to the previous menu, then press the **Decode** softkey to turn on serial decode.
- 10** If the oscilloscope is stopped, press the **Run/Stop** key to acquire and decode data.

NOTE

If the setup does not produce a stable trigger, the UART/RS232 signal may be slow enough that the oscilloscope is AutoTriggering. Press the **Mode/Coupling** key, then press the **Mode** softkey to set the trigger mode from **Auto** to **Normal**.

You can use the **Zoom** horizontal sweep mode for easier navigation of the acquired data.

Interpreting Decoded UART/RS232 Data

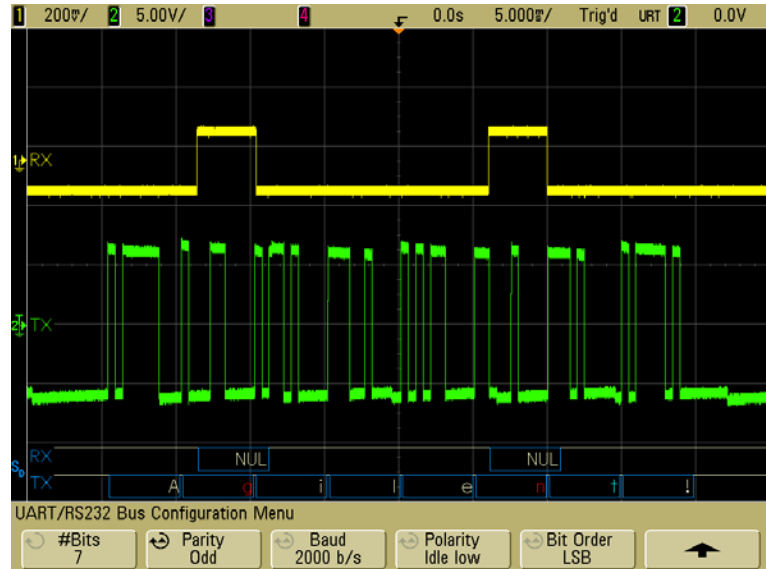

- An idle bus is shown in white.
- An active bus is shown in dark blue, with vertical lines designating the start and end of each data word.
- When using 5-8 bit formats, the decoded data is displayed in white (in binary, hex, or ASCII).
- When using the 9 bit format, all data words are displayed in green, including the 9th bit. The 9th bit is displayed on the left.
- When a data word value is selected for framing, it is displayed in light blue. When using 9-bit data words, the 9th bit will also be displayed in light blue.
- The displayed contents of a data word may extend beyond the associated rectangle if the timebase setting is too slow and an idle period follows.
- When the horizontal scale setting does not permit the display of all available decoded data, red dots will appear in the decoded bus to mark the location of hidden data. Expand the horizontal scale to allow the data to display.

5 Displaying Data

- An unknown (undefined) bus is shown in red.
- A parity error will cause the associated data word to be shown in red, which includes the 5-8 data bits and the optional 9th bit.

UART/RS232 Totalizer

The UART/RS232 totalizer consists of counters that provide a direct measure of bus quality and efficiency. The totalizer appears on screen whenever UART/RS232 Decode is ON in the Serial Decode Menu.

The totalizer is running, counting frames and calculating the percentage of error frames, even when the oscilloscope is stopped (not acquiring data).

The ERR (error) counter is a count of Rx and Tx frames with parity errors. The TX FRAMES and RX FRAMES counts include both normal frames and frames with parity errors. When an overflow condition occurs, the counter displays **OVERFLOW**.

The counters can be reset to zero by pressing the **Reset UART Counters** softkey.

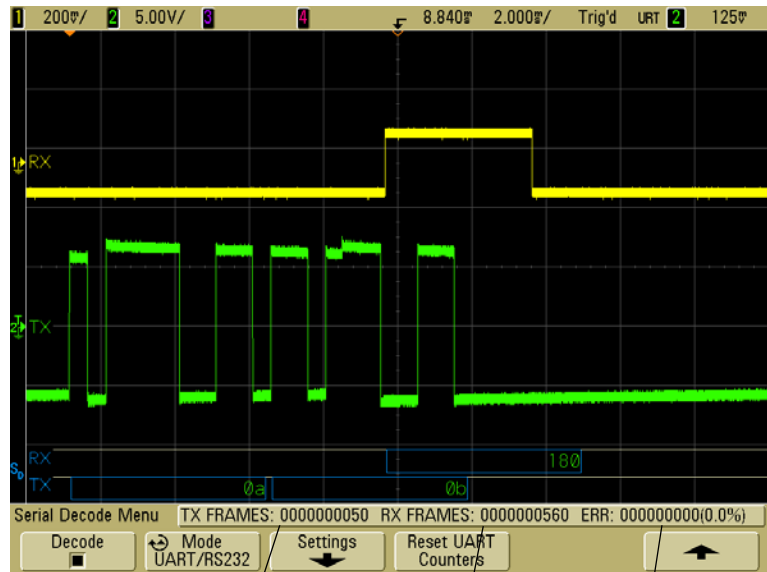

Tx Frame Count

Rx Frame Count

Error Frame Count and Percent

To reduce the random noise on a signal

If the signal you are probing is noisy, you can set up the oscilloscope to reduce the noise on the displayed waveform. First, you stabilize the displayed waveform by removing the noise from the trigger path. Second, you reduce the noise on the displayed waveform.

- 1 Connect a signal to the oscilloscope and obtain a stable display.
- 2 Remove the noise from the trigger path by turning on high-frequency rejection (HF reject), low-frequency rejection (LF reject), or noise rejection (see the following pages).
- 3 Use averaging (see [page 211](#)) to reduce noise on the displayed waveform.

HF Reject

High-frequency reject (HF reject) adds a low-pass filter with the 3-dB point at 50 kHz. HF reject removes high-frequency noise, such as AM or FM broadcast stations, from the trigger path.

- Press **Mode/Coupling** → **HF Reject**.

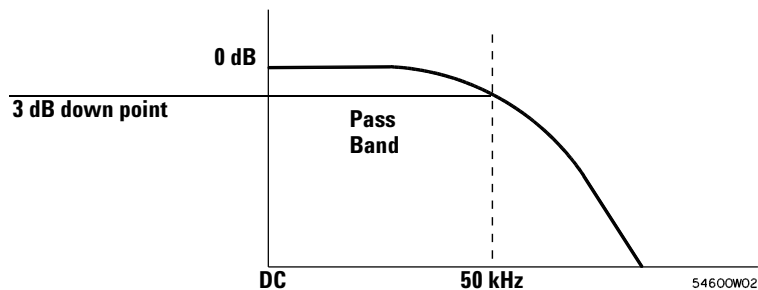

LF Reject

Low-frequency reject (LF reject) adds a high-pass filter with the 3-dB point at 50 kHz. LF reject removes low-frequency signals, such as power line noise, from the trigger path.

- Press **Mode/Coupling**→**Coupling**→**LF Reject**.

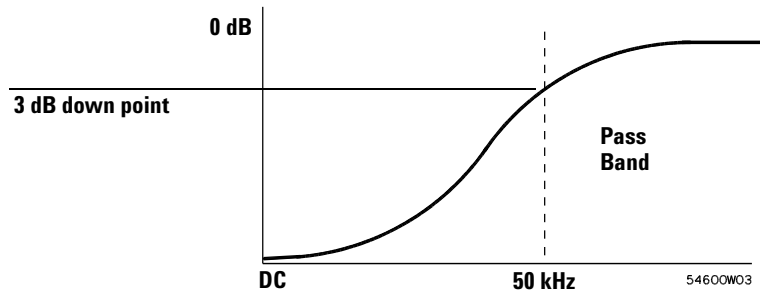

Noise rejection

Noise reject increases the trigger hysteresis band. By increasing the trigger hysteresis band, you reduce the possibility of triggering on noise. However, this also decreases the trigger sensitivity so that a slightly larger signal is required to trigger the oscilloscope.

- Press **Mode/Coupling**→**HF Reject**.

To capture glitches or narrow pulses with peak detect and infinite persistence

A glitch is a rapid change in the waveform that is usually narrow as compared to the waveform. Peak detect mode can be used to more easily view glitches or narrow pulses. In peak detect mode, narrow glitches and sharp edges are displayed more brightly than when in Normal acquire mode, making them easier to see.

To characterize the glitch, use the cursors or the automatic measurement capabilities of the oscilloscope.

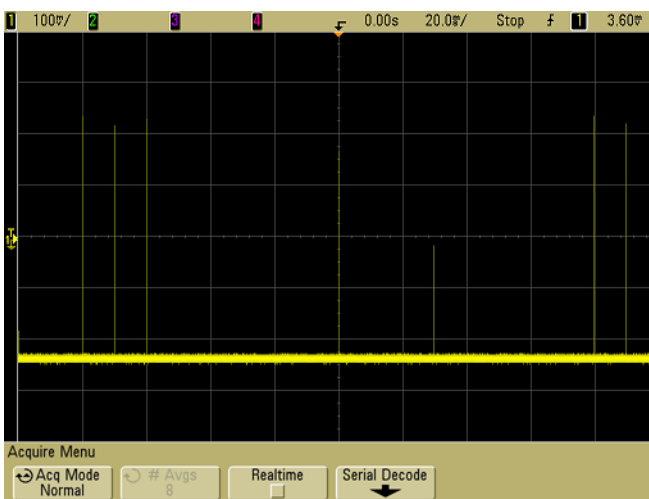

Figure 41 15 ns Narrow Pulse, 20 ns/div, Normal Mode

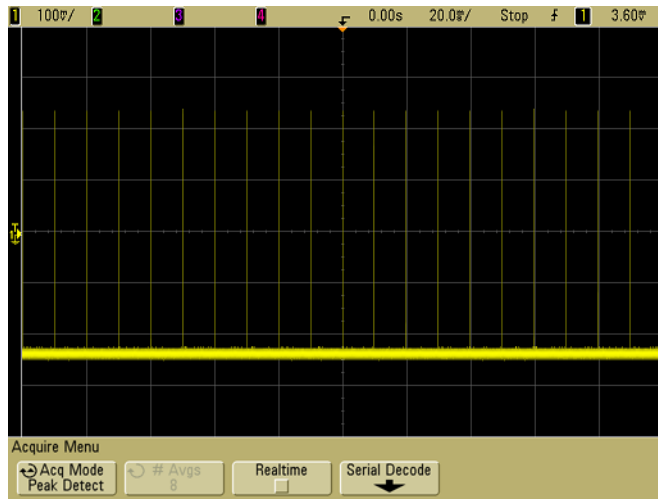

Figure 42 15 ns Narrow Pulse, 20 ms/div, Peak Detect Mode

Using peak detect mode to find a glitch

- 1 Connect a signal to the oscilloscope and obtain a stable display.
- 2 To find the glitch, press the **Acquire** key, then, press the **Acq Mode** softkey until **Peak Detect** is selected.
- 3 Press the **Display** key then press the ∞ **Persist** (infinite persistence) softkey.

Infinite persistence updates the display with new acquisitions but does not erase previous acquisitions. New sample points are shown at normal intensity while previous acquisitions are displayed in gray at lower intensity. Waveform persistence is not kept beyond the display area boundary.

Press the **Clear Display** softkey to erase previously acquired points. The display will accumulate points until ∞ **Persist** is turned off.

- 4 Characterize the glitch with zoom sweep:
 - a Press the **Menu/Zoom** key, then press the **Zoom** softkey.
 - b To obtain a better resolution of the glitch, expand the time base.
 - c Use the horizontal position knob ($\blacktriangleleft\blacktriangleright$) to pan through the waveform to set the expanded portion of the main sweep around the glitch.

How AutoScale Works

AutoScale automatically configures the oscilloscope to best display the input signals by analyzing any waveforms present at each channel and at the external trigger input.

AutoScale finds, turns on, and scales any channel with a repetitive waveform that has a frequency of at least 50 Hz, a duty cycle greater than 0.5%, and an amplitude of at least 10 mV peak-to-peak. Any channels that do not meet these requirements are turned off.

The trigger source is selected by looking for the first valid waveform starting with external trigger, then continuing with the highest number channel down to the lowest number channel.

During AutoScale, the horizontal position (delay) is set to 0.0 seconds, the sweep speed setting is a function of the input signal (about 2 periods of the triggered signal on the screen), and the triggering mode is set to edge. Vectors remain in the state they were before the AutoScale.

Undo AutoScale

Press the **Undo AutoScale** softkey to return the oscilloscope to the settings that existed before you pressed the **AutoScale** key.

This is useful if you have unintentionally pressed the **AutoScale** key or do not like the settings AutoScale has selected and want to return to your previous settings.

Specifying the Channels Displayed After AutoScale

The **Channels** softkey selection determines which channels will be displayed on subsequent AutoScales.

- **All Channels** – The next time you press **AutoScale**, all channels that meet the requirements of AutoScale will be displayed.
- **Only Displayed Channels** – The next time you press **AutoScale**, only the channels that are turned on will be examined for signal activity. This is useful if you only want to view specific active channels after pressing **AutoScale**.

Preserving the Acquisition Mode During AutoScale

The acquisition mode is normally switched to Normal when AutoScale is performed. AutoScale can be set to leave the acquisition mode unchanged if you prefer this option.

Choose Normal to make the oscilloscope switch to Normal acquisition mode whenever the **AutoScale** key is pressed. This is the default mode.

Choose Preserve to make the oscilloscope remain in the acquisition mode you have chosen when the **AutoScale** key is pressed.



6 Saving and Printing Data

- Printing the oscilloscope's display [254](#)
- Supported Printers [256](#)
- Saving oscilloscope data [258](#)
- Selecting a destination for your saved data [259](#)
- Selecting a file name [260](#)
- Waveform Trace and Oscilloscope Setup [262](#)
- Display Image and Waveform Data File Formats [262](#)
- Choosing save settings [263](#)
- To save a waveform and/or setup to a USB device [265](#)
- To save a waveform and/or setup to the oscilloscope's internal memory [265](#)
- To recall waveform trace and/or oscilloscope setup [266](#)
- File explorer [266](#)
- To use the file explorer [268](#)
- Secure Environment Mode Option [269](#)



Printing the oscilloscope's display

To print the oscilloscope's display:

- 1 Connect a USB printer to either the USB port on the front panel or the rectangular USB host port on the rear panel. A list of supported printers is on [page 256](#).
- 2 Press the **Print** key (labeled **Quick Print** on older models) on the front panel.
- 3 Press the **Press to Print** softkey.

NOTE

The Print function remembers the screen you were on before you pressed the print key. The last menu visited will be shown in the printout. Therefore, if you have measurements (Amplitude, Frequency, etc.) showing on the display before you select Print, the measurements will be shown on the printout.

To print the display showing the Print Configuration Menu at the bottom, press the **Print** key twice, then press the **Press to Print** softkey.

Print options

You can print scale factors, print in color or grayscale, and choose whether to print the waveform on a separate sheet of paper (form feed) from the factors (if factors are selected). To conserve printer ink, you can invert the graticule colors so that the background is white instead of black.

The Print Configuration menu is displayed when you press the **Print** key. The print option softkeys and the **Press to Print** softkey are ghosted (not available) until a printer is connected.

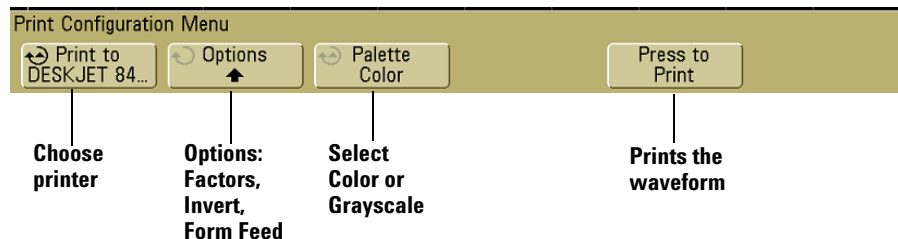

Selecting print options

Press the **Options** softkey to change the following options:

- **Factors** – Select **Factors** if you want the oscilloscope scale factors to be included on your printout. Oscilloscope scale factors include vertical, horizontal, trigger, acquisition, math, and display settings.
- **Invert Graticule Colors** – The **Invert Graticule Colors** option can be used to reduce the amount of black ink it takes to print oscilloscope images by changing the black background to white. **Invert Graticule Colors** is the default mode.

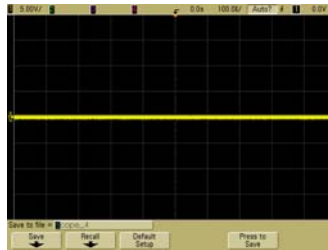

Graticule Not Inverted

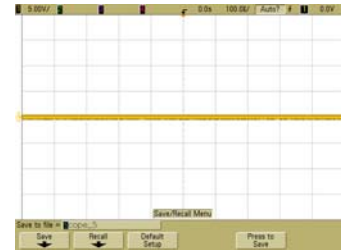

Graticule Inverted

- **Form Feed** – The **Form Feed** option can be selected to send a form feed command to the printer after the waveform is printed and before the factors are printed. Switch **Form Feed** off if you want factors printed on the same sheet of paper with the waveform. This option only has an effect when the **Factors** option is selected.

Palette

Press the **Palette** softkey to change the following options.

- **Color** – When **Color** printing is selected, the traces are printed in color.
- **Grayscale** – When **Grayscale** printing is selected, the traces are printed in shades of gray rather than in color.

Supported Printers

The following HP printers, available in stores at the time this manual was written, have been tested and found to be compatible with the 5000 Series oscilloscopes. Visit www.agilent.com/find/dso5000 and select **Technical Support**, then **FAQs** for an updated list of compatible printers.

Deskjet 672C
Deskjet 694C
Deskjet 840C
Deskjet 932C
Deskjet 935C
Deskjet 952C
Deskjet 6940
Deskjet 6980
Deskjet 9800
Officejet 7310
Officejet 7410
PhotoSmart C5180
PhotoSmart C6180
PhotoSmart C7100
PhotoSmart D7160
PhotoSmart D7360
PhotoSmart 8750

The following HP printers will likely work with the oscilloscope, but have not been tested for compatibility.

Deskjet 350C
Deskjet 610C & 612C
Deskjet 630C & 632C
Deskjet 656
Deskjet 825
Deskjet 845C
Deskjet 648C
Deskjet 810C & 812C & 815C & 816C
Deskjet 842C
Deskjet 920
Deskjet 932C & 935C
Deskjet 940 & 948
Deskjet 952C
Deskjet 960
Deskjet 970C

Deskjet 980
 Deskjet 990C
 Deskjet 995
 Deskjet 1220C & 1125C
 Deskjet 3816 & 3820
 Deskjet 5550 & 5551
 Deskjet 6122 & 6127
 Deskjet 5600 & 5100 & 5800
 Deskjet 6540 & 6520
 Deskjet 5740
 Deskjet 6840
 Deskjet 3740 & 3840
 Deskjet CP1160 & CP1700
 Deskjet 9300 & 9600
 PhotoSmart PS100 & PS130 & PS230 & PS140 & PS240 & 1000 & 1100
 PhotoSmart 320 & 370
 PhotoSmart P2500 & P2600
 PhotoSmart PS1115 & PS1215 & PS12818 & PS1315
 PhotoSmart PS7150 & PS7350 & PS7550
 PhotoSmart PS7960 & PS7760 & PS7660 & PS7260 & PS7268
 PhotoSmart 7400 & 8100 & 8400
 PhotoSmart 2600 & 2700
 PSC 1100 & 1200 & 1300 & 1310
 PSC 2100 & 2150 & 2200 & 2300 & 2400 & 2500 & 2170
 PSC 1600 & 2350
 Officejet 5100 & 6100 & 6150 & 7100 & 4100 & 4105 & 4200 & 5500 & 9100
 Officejet 7200 & 7300 & 7400 & 6200
 Apollo P2100 & P2150
 Apollo P2200 & P2250
 E-Printer e20
 Business InkJet 2200 & 2230 & 2250 & 2280 & 3000 & 1100 & 2300
 Business InkJet 1200
 Deskjet 600
 Deskjet 640 & 642 & 644
 Deskjet 660C
 Deskjet 670 & 670TV & 672TV & 672C
 Deskjet 680C & 682C
 Deskjet 690C & 692C & 693C & 694C & 695C & 697C
 Deskjet 830C & 832C
 Deskjet 840C & 843
 Deskjet 880 & 882C
 Deskjet 895C
 Deskjet 930C
 Deskjet 950C & 955 & 957
 Deskjet 975C

Saving oscilloscope data

Here are a few points about saving oscilloscope data:

- You can save a waveform trace and recall it later. The recalled trace appears in cyan (blue).
- You can save oscilloscope setup parameters and recall them later. The setup file stores settings such as horizontal timebase, vertical sensitivity, trigger mode, trigger level, measurements, cursors, and math functions. This lets you easily and consistently set up the oscilloscope to make a particular measurement.
- There is a distinction between print and save: print always refers to printing the display to a printer. Save means saving data to a USB drive or the oscilloscope's internal memory.

The following table shows types of data and where the data can be saved.

Table 12 Saving Oscilloscope Data

Type of Data	Can be saved to:	
	USB drive	Oscilloscope's internal memory
Oscilloscope setup and waveform trace	Yes	Yes*
Display image and waveform data files (BMP, PNG, CSV, ASCII XY, BIN)	Yes	No
*If Secure Environment Mode option is installed then data is prevented from being stored in the oscilloscope's internal memory.		

NOTE

You can also save the oscilloscope's display image using a web browser. See ["Printing the oscilloscope's display from a web browser"](#) on page 34 for details.

Selecting a destination for your saved data

Press **Save/Recall**→**Save** to access the Save menu and select a destination for saving your data.

Press to go/Location/Save to softkey (Using the oscilloscope's File Explorer)

The second softkey from the left in the Save menu is the file explorer softkey.

If no USB storage device is connected to the oscilloscope, you will only be able to save Trace and Setup files to the oscilloscope's internal memory. You will not be able to save display image files or waveform data files as described on [page 262](#) unless a USB storage device is connected.

Rotate the Entry knob to align the selection arrow with “**C:**” and push the **Press to go** softkey to select the destination. Then rotate the Entry knob to align the arrow with the “**setups**” directory and press the **Save to** softkey to select a file (**intern_n**) to be overwritten.

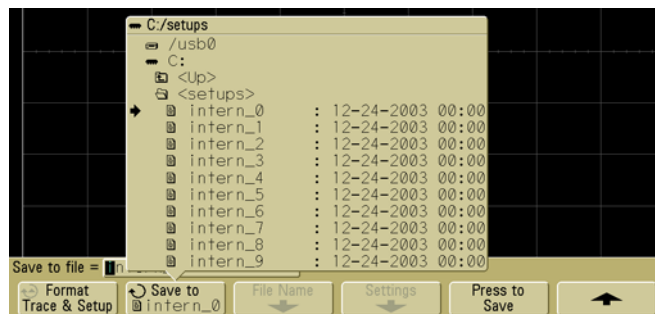

NOTE

The File Explorer in the Save and Recall menus can be used to save the following file types: oscilloscope setup, waveform trace, display image and waveform data. It can be used to recall oscilloscope setup and waveform trace files.

The File Explorer in the Utility menu can be used for loading files into the oscilloscope or deleting files.

If one or more USB storage devices are connected to the oscilloscope, you can navigate to the USB device using the same method. The following display image shows an image ready to be saved to a subfolder called “Rise time” on a USB device. Push the Entry knob to save the image.

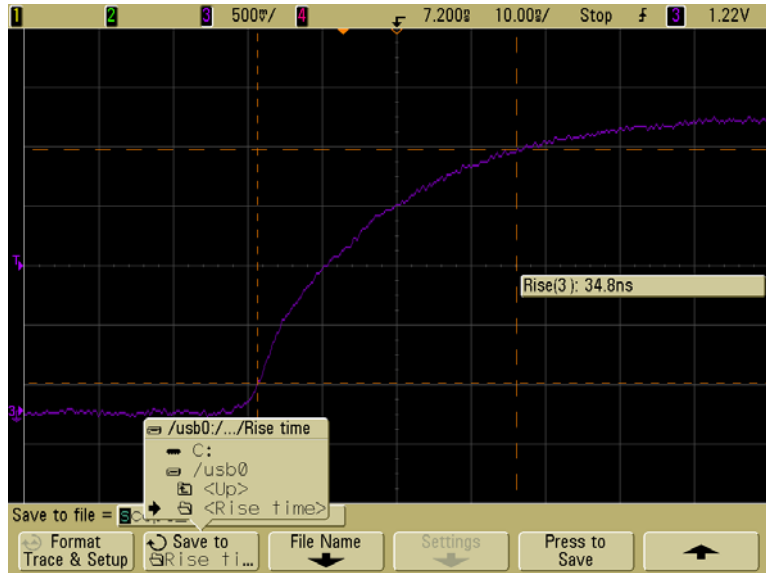

Selecting a file name

Overwriting a file

You can choose to overwrite an existing file name by browsing to that file and selecting it, then choosing **Press to Save**.

Creating a new file name

- 1 Press the **File Name** softkey in the Save menu. (You must have a USB storage device connected to the oscilloscope for this softkey to be active.)
- 2 Repeatedly turn and push the Entry knob to select letters and numbers for the new file name. Or, you can press the **Spell** softkey and press the **Enter** softkey to create the new file name.

- 3 You can press the **Enter** softkey or the Entry knob to move the cursor forward within the file name.
- 4 You can press the **Delete Character** softkey to delete the current character and shift the rest of the characters to the left.
- 5 When you select the **Auto Increment** option, the oscilloscope will add a numeric suffix to your file name, and increment the number with each successive save. It will truncate characters as necessary when the file name length is at maximum and more digits are required for the numeric portion of the file name.
- 6 Press the **Press to Save** softkey to save the file.

Waveform Trace and Oscilloscope Setup

When the **Trace & Setup** option is selected from the **Format** softkey, both waveform trace and oscilloscope setup are saved to the USB drive or the oscilloscope's internal memory. After saving, you can choose to recall the trace, the setup, or both.

The trace is saved with the file extension TIF and the setup is saved with the extension SCP. These extensions can be seen using the File Explorer, but they do not appear when using the file browser in the Recall menu.

Display Image and Waveform Data Files

You can save the display image (file type BMP or PNG) or waveform data (file type CSV, ASCII, BIN, or ALB) to a USB device that you connect to the oscilloscope.

Display Image and Waveform Data File Formats

The data which is displayed on-screen is the data that will be saved to the file.

Display image and waveform data files can be saved on a USB drive, but they can not be saved to the oscilloscope's internal memory.

You can save the display image or waveform data in image (BMP, PNG) or data (CSV, ASCII, BIN, ALB) file formats. Press **Save/Recall**→**Save**→**Format** to select a format.

- **BMP (8-bit) image file** - The screen image is converted to a smaller, lower resolution bitmap file of the complete screen (including the status line and softkeys).
- **BMP (24-bit) image file** - This is a larger, high-resolution bitmap file of the complete screen.
- **PNG (24-bit) image file** - This is an image file that uses lossless compression. Files are much smaller than the BMP format.
- **CSV data file** - This creates a file of comma-separated variable values of all displayed channels and math waveforms. This format is suitable for spreadsheet analysis.

- **ASCII XY data file** - This creates a file of comma-separated variables for each displayed channel. If the oscilloscope acquisition is stopped, then data records greater than 1000 points can be written. This format is also suitable for spreadsheets.
- **BIN data file** - This creates a binary file with a header, and data in the form of time and voltage pairs. This file is much smaller than the ASCII XY data file. If the oscilloscope acquisition is stopped, then data records greater than 1000 points can be written.
- **ALB data file** - This creates a file in an Agilent proprietary format which can be read by Agilent logic analyzers.

Choosing save settings

Press **Save/Recall**→**Save**→**Settings** to change the following options.

These settings are not applicable when the format “Trace&Setup” is selected.

Factors

Select **Factors** if you want the oscilloscope scale factors to be included. Oscilloscope scale factors include vertical, horizontal, trigger, acquisition, math, and display settings. The scale factors will be sent to a separate file with a TXT extension.

Invert Graticule Colors

This setting is applicable when you have chosen BMP or PNG using the **Format** softkey.

The **Invert Graticule Colors** option can be used to reduce the amount of black ink it takes to print oscilloscope images by changing the black background to white. **Invert Graticule Colors** is the default mode. **Invert Graticule Colors** is available when the BMP and PNG formats are selected.

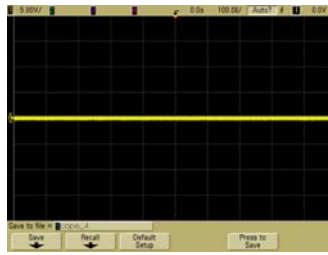

Graticule Not Inverted

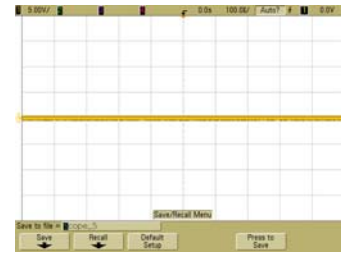

Graticule Inverted

Palette

Press the **Palette** softkey to change the following options. The Palette options are available when the BMP and PNG formats are selected.

- **Color** – When **Color** printing is selected, the traces are printed in color. Color printing is not applicable to CSV format.
- **Grayscale** – When **Grayscale** printing is selected, the traces are printed in shades of gray rather than in color. Grayscale printing is not applicable to CSV format.

Length Control

The **Length** softkey is available when the CSV, ASCII XY, BIN, or ALB formats are selected. **Length** sets the number of data points that will be output to the file. **Length** can be set to 100, 250, 500, or 1000 when the acquisition is running, or more when the acquisition is stopped. However, if serial decode is on, the full record length is always output.

Only displayed data points are output. Therefore, adjust the Horizontal controls to display the data you want to save.

The Length control will perform a “1 of n” decimation of the data when necessary. For example: if the **Length** is set to 1000, and you are displaying a record that is 5000 data points in length, four of each five data points will be decimated, creating an output file 1000 data points in length.

For more information see [“Minimum and Maximum Values in CSV Files”](#) on page 281.

To save a waveform and/or setup to a USB device

- 1 Insert a USB drive into the front or rear USB device port.
- 2 Press the **Save/Recall** key.
- 3 Press the **Save** softkey. The proposed file name will be shown in the “**Save to file**” prompt above the **Save** softkey. (If you want to change the file name, press the **File Name** softkey. See [“Creating a new file name”](#) on page 260 for details.)
- 4 Choose a file format using the **Format** softkey. For file format information see [“Display Image and Waveform Data File Formats”](#) on page 262.
- 5 Press the **Press to Save** softkey.

To save a waveform and/or setup to the oscilloscope’s internal memory

- 1 Press the **Save/Recall** key.
- 2 Press the **Save** softkey.
- 3 Press the **Format** softkey and choose **Trace and Setup**.
- 4 Press the **Save to** softkey. Then rotate the **Entry** knob to navigate to the “C:\setups” directory, then choose one of the files to overwrite (intern_0 through intern_9). You can push the **Entry** knob to make your directory and file selections.
- 5 Press the **Press to Save** softkey or select the file using the **Entry** knob and then press the **Entry** knob.

To recall waveform trace and/or oscilloscope setup

A recalled trace is typically used for a quick comparison of measurement results. For example, you might save a trace of a waveform to use as a reference, then make a similar measurement on a test system and then recall the saved trace to observe any differences.

- 1 Press the **Save/Recall** key.
- 2 Press the **Recall** softkey. The Recall Menu will be displayed.
- 3 Press the **Recall:** softkey in the Recall Menu and choose **Setup, Trace,** or **Trace and Setup.**
- 4 Press the second softkey from the left and navigate to the oscilloscope's internal memory location or the USB drive that holds the saved trace and/or setup. See [“File explorer”](#) (below) for more information.
- 5 Press the **Press to Recall** softkey.

File explorer

The File Explorer lets you navigate the file system. Using the File Explorer you can save, recall, load, and delete files.

File system The user-accessible file system consists of ten internal memory locations, plus external USB memory devices you connect to the USB device ports on the oscilloscope.

Internal memory The ten internal nonvolatile memory locations are located on the oscilloscope at C:\setups and are named intern_0 through intern_9. You can save waveform trace and oscilloscope setup in each of the ten internal memory locations, but you can not save display image files or waveform data files in the oscilloscope's internal memory. The latter must be stored on USB devices.

USB devices Most USB storage devices are compatible with the oscilloscope. However, certain devices may be incompatible, and may not be able to be read or written to.

When the USB storage device is connected to the oscilloscope's front or rear USB host port, a small four-color circle icon may be displayed briefly as the USB device is read.

You do not need to “eject” the USB device before removing it. Simply ensure that any file operation you've initiated is done, and remove the USB drive from the oscilloscope's host port.

Do not connect USB devices that identify themselves as hardware type “CD” because these devices are not compatible with the 5000 Series oscilloscopes.

If two USB mass storage devices are connected to the oscilloscope, the first one is designated “USB0” and the second one is designated “USB5,” not “USB1.” This numbering method is normal; it is inherent in the USB driver.

A file that has been deleted from the USB mass storage device cannot be recovered by the oscilloscope.

NOTE

Regarding USB Ports:

The USB port on the front panel, and the USB port on the rear panel labeled “HOST” are USB Series A receptacles. These are the receptacles to which you can connect USB mass storage devices and printers.

The square receptacle on the rear panel labeled “DEVICE” is provided for controlling the oscilloscope over USB. See the *5000 Series Oscilloscopes Programmer's Quick Start Guide* or the *5000 Series Oscilloscopes Programmer's Reference* for more information. To access these documents online, direct your web browser to www.agilent.com/find/dso5000 and select Library.

System software System software files (software updates which can be downloaded from www.agilent.com/find/dso5000sw) can be loaded into the oscilloscope. See “[Software and firmware updates](#)” on page 272 for more information.

To use the file explorer

Files can be loaded and deleted using the file explorer.

You can create directories on a USB mass storage device using your PC or other instrument. You can navigate to any directory on the USB device by rotating the Entry knob and pressing the softkey.

- 1 Connect a USB mass storage device with the files to be loaded or deleted to the USB port on the front or the rear of the oscilloscope. A small four-color circle icon may be displayed as the USB device is read.
- 2 Press **Utility**→**File Explorer**.
- 3 Turn the Entry knob to select the desired file on the USB mass storage device. The left-most softkey will be labeled **Press to go** when pointing at a directory that can be selected, **Location** when pointing to a directory that is currently selected, and **Selected** when pointing to a file that can be loaded or deleted. Pressing the softkey will initiate the selected activity.

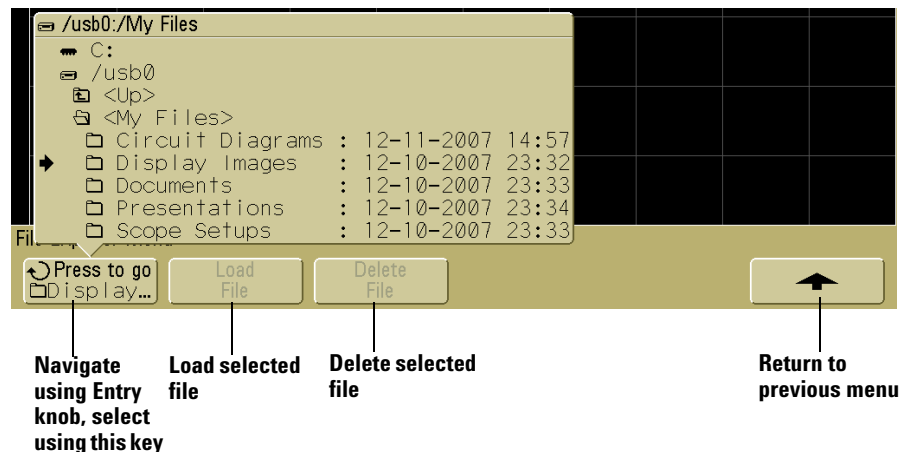

Secure Environment Mode Option

Secure environment mode is compliant to National Industrial Security Program Operating Manual (NISPOM) Chapter 8 requirements.

When you order your oscilloscope with the secure environment mode option, trace and setup data are stored to internal volatile memory (rather than internal non-volatile memory).

Oscilloscope setup, waveform, and trace data are erased when the power is shut off. This ensures that any setup, waveform, and trace data will not be visible to the next user upon power-up. The clock, LAN, and GPIB settings are not discarded upon power-down.

To permanently store data, you can save it to an external device through one of the oscilloscope's USB ports.

Secure environment mode can not be disabled.

Oscilloscopes equipped with the secure environment mode option will have "SEC" displayed in the Installed Licenses line of the "About Oscilloscope" display. To access the About Oscilloscope display, press the **Utility** key, then press the **Service** softkey, then press the **About Oscilloscope** softkey.

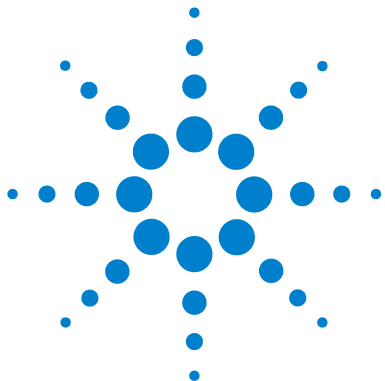

7 Reference

- Software and firmware updates [272](#)
- To set up the I/O port [273](#)
- To check warranty and extended services status [273](#)
- To return the instrument [274](#)
- To clean the oscilloscope [274](#)
- Binary Data (.bin) [275](#)
- Minimum and Maximum Values in CSV Files [281](#)



Software and firmware updates

From time to time Agilent Technologies releases software and firmware updates for its products. To search for firmware updates for your oscilloscope, point your web browser to www.agilent.com/find/dso5000 and select **Technical Support**, then select **Software Downloads & Utilities**.

To view the currently installed software and firmware press **Utility**→**Service**→**About Oscilloscope**.

To set up the I/O port

The oscilloscope can be controlled via GPIB, LAN, or USB. By default, all three are active, although they can be selected or disabled using the **Control** softkey in the I/O menu (press **Utility**→**I/O**).

The oscilloscope's I/O configuration, including its IP address and hostname, can be viewed by pressing **Utility**→**I/O**.

To change the I/O controller settings, press the **Configure** softkey, and choose the I/O connection type (GPIB, LAN, or USB).

For instructions on setting up the oscilloscope to run from a controller via LAN, GPIB, or USB, see the *Programmer's Quick Start Guide*.

To check warranty and extended services status

To learn the warranty status of your oscilloscope:

- 1 Point your web browser to:
www.agilent.com/find/warrantystatus
- 2 Enter your product's model number and serial number. The system will search for the warranty status of your product and display the results. If the system cannot find your product's warranty status, select **Contact Us** and speak with an Agilent Technologies representative.

To return the instrument

Before shipping the oscilloscope to Agilent Technologies, contact your nearest Agilent Technologies sales or service office for additional details. Information on contacting Agilent Technologies can be found at www.agilent.com/find/contactus.

1 Write the following information on a tag and attach it to the oscilloscope.

- Name and address of owner
- Model number
- Serial number
- Description of service required or failure indication

2 Remove accessories from the oscilloscope.

Only return accessories to Agilent Technologies if they are associated with the failure symptoms.

3 Package the oscilloscope.

You can use the original shipping container, or provide your own materials sufficient to protect the instrument during shipping.

4 Seal the shipping container securely, and mark it FRAGILE.

To clean the oscilloscope

1 Remove power from the instrument.

2 Clean the external surfaces of the oscilloscope with a soft cloth dampened with a mixture of mild detergent and water.

3 Make sure that the instrument is completely dry before reconnecting it to a power source.

Binary Data (.bin)

The binary data format stores waveform data in binary format and provides data headers that describe that data.

Because the data is in binary format, the size of the file is approximately 5 times smaller than the XYPairs format.

If more than one source is on, you will save all displayed sources, except math functions, to a file.

When the oscilloscope is in the Peak Detect acquisition mode, the minimum and maximum value waveform data points are saved to the file in separate waveform buffers. The minimum value data points are saved first; then, the maximum value data points are saved.

Binary Data in MATLAB

Binary data from the 5000 Series oscilloscope can be imported to The MathWorks MATLAB®. You can download the appropriate MATLAB functions from the Agilent Technologies web site at www.agilent.com/find/dso5000sw.

Agilent provides the .m files, which need to be copied into the work directory for MATLAB. The default work directory is C:\MATLAB7\work.

Binary Header Format

File Header

There is only one file header in a binary file. The file header consists of the following information.

Cookie Two byte characters, AG, that indicate the file is in the Agilent Binary Data file format.

Version Two bytes that represent the file version.

File Size A 32-bit integer that is the number of bytes that are in the file.

Number of Waveforms A 32-bit integer that is the number of waveforms that are stored in the file.

Waveform Header

It is possible to store more than one waveform in the file, and each waveform stored will have a waveform header. The waveform header contains information about the type of waveform data that is stored following the waveform data header.

Header Size A 32-bit integer that is the number of bytes in the header.

Waveform Type A 32-bit integer that is the type of waveform stored in the file:

- 0 = Unknown.
- 1 = Normal.
- 2 = Peak Detect.
- 3 = Average.
- 4 = Not used in 5000 Series oscilloscopes.
- 5 = Not used in 5000 Series oscilloscopes.
- 6 = Not used in 5000 Series oscilloscopes.

Number of Waveform Buffers A 32-bit integer that is the number of waveform buffers required to read the data.

Points A 32-bit integer that is the number of waveform points in the data.

Count A 32-bit integer that is the number of hits at each time bucket in the waveform record when the waveform was created using an acquisition mode like averaging. For example, when averaging, a count of four would mean every waveform data point in the waveform record has been averaged at least four times. The default value is 0.

X Display Range A 32-bit float that is the X-axis duration of the waveform that is displayed. For time domain waveforms, it is the duration of time across the display. If the value is zero then no data has been acquired.

X Display Origin A 64-bit double that is the X-axis value at the left edge of the display. For time domain waveforms, it is the time at the start of the display. This value is treated as a double precision 64-bit floating point number. If the value is zero then no data has been acquired.

X Increment A 64-bit double that is the duration between data points on the X axis. For time domain waveforms, this is the time between points. If the value is zero then no data has been acquired.

X Origin A 64-bit double that is the X-axis value of the first data point in the data record. For time domain waveforms, it is the time of the first point. This value is treated as a double precision 64-bit floating point number. If the value is zero then no data has been acquired.

X Units A 32-bit integer that identifies the unit of measure for X values in the acquired data:

- 0 = Unknown.
- 1 = Volts.
- 2 = Seconds.
- 3 = Constant.
- 4 = Amps.
- 5 = dB.
- 6 = Hz.

Y Units A 32-bit integer that identifies the unit of measure for Y values in the acquired data. The possible values are listed above under “X Units”.

Date A16-bit character array, left blank in the 5000 Series oscilloscope.

Time A 16-bit character array, left blank in the 5000 Series oscilloscope.

Frame A 24 byte character array that is the model number and serial number of the oscilloscope in the format of: MODEL#:SERIAL#.

Waveform Label A 16 byte character array that contains the label assigned to the waveform.

Time Tags A 64-bit double, not used in the 5000 Series oscilloscope.

Segment Index A 32-bit unsigned integer, not used in the 5000 Series oscilloscope.

Waveform Data Header

A waveform may have more than one data set. Each waveform data set will have a waveform data header. The waveform data header consists of information about the waveform data set. This header is stored immediately before the data set.

Waveform Data Header Size A 32-bit integer that is the size of the waveform data header.

Buffer Type A 16-bit short that is the type of waveform data stored in the file:

- 0 = Unknown data.
- 1 = Normal 32-bit float data.
- 2 = Maximum float data.
- 3 = Minimum float data.
- 4 = Not used in 5000 Series oscilloscopes.
- 5 = Not used in 5000 Series oscilloscopes.
- 6 = Not used in 5000 Series oscilloscopes.

Bytes Per Point A 16-bit short that is the number of bytes per data point.

Buffer Size A 32-bit integer that is the size of the buffer required to hold the data points.

Example Program for Reading Binary Data

To find an example program for reading binary data, direct your web browser to www.agilent.com/find/dso5000, select Technical Support, then select Drivers & Software. Then select “Example Program for Reading Binary Data”.

Examples of Binary Files

Single Acquisition Multiple Channels

The following picture shows a binary file of a single acquisition with multiple oscilloscope channels.

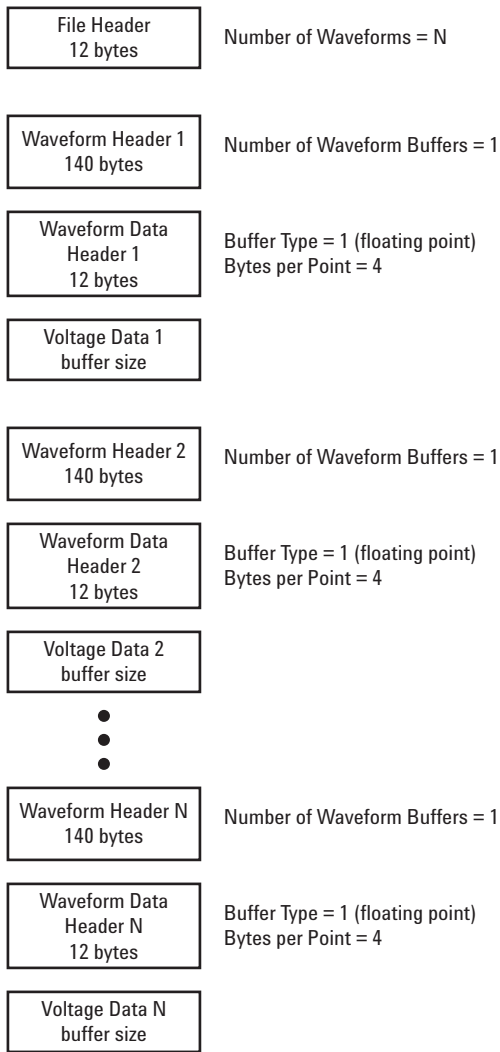

Minimum and Maximum Values in CSV Files

If you are running a Quick Measurement Minimum or Maximum measurement, the minimum and maximum values shown in the Quick Measurement display may not appear in the CSV file.

Explanation:

When the oscilloscope's sample rate is 4 GSa/s, a sample will be taken every 250 ps. If the sweep speed is set to 100 ns/div, there will be 1000 ns of data displayed (because there are ten divisions across the screen). To find the total number of samples the oscilloscope will take:

$$1000ns \times 4Gsa/s = 4000samples$$

For measurement data, the oscilloscope will decimate the 4000 points to 1000 points that will fit on the display. This decimation will not lose track of the min and max values at each of the 1000 horizontal data points, and min and max values will be displayed on screen. However, the oversampled data is also processed to provide a best-estimate value at each of the 1000 horizontal points. The data in the CSV file will be the best-estimate value at each of the 1000 horizontal points. Therefore, the min and max values may not appear in the CSV file.

This occurs when oversampling occurs
(10 * seconds per division * maximum sample rate > 1000).



8 Power and Environmental Conditions

Power Requirements	284
Measurement Category	285
Environmental Conditions	287
Specifications	288
Acknowledgements	288
Contact us	289

This chapter describes the power requirements and environmental conditions appropriate for the Agilent 5000 Series oscilloscopes.



Power Requirements

Line voltage range ~Line 120 W max, 96-144 V/48-440 Hz,
192-288 V/48-66 Hz, automatic selection

Line frequency 50/60 Hz, 100-240 VAC; 440 Hz, 100-132 VAC

Power usage 110 W max

Measurement Category

The 5000 Series oscilloscope is intended to be used for measurements in Measurement Category I.

WARNING

Use this instrument only for measurements within its specified measurement category.

Measurement Category Definitions

Measurement category I is for measurements performed on circuits not directly connected to MAINS. Examples are measurements on circuits not derived from MAINS, and specially protected (internal) MAINS derived circuits. In the latter case, transient stresses are variable; for that reason, the transient withstand capability of the equipment is made known to the user.

Measurement category II is for measurements performed on circuits directly connected to the low voltage installation. Examples are measurements on household appliances, portable tools and similar equipment.

Measurement category III is for measurements performed in the building installation. Examples are measurements on distribution boards, circuit-breakers, wiring, including cables, bus-bars, junction boxes, switches, socket-outlets in the fixed installation, and equipment for industrial use and some other equipment, for example, stationary motors with permanent connection to the fixed installation.

Measurement category IV is for measurements performed at the source of the low-voltage installation. Examples are electricity meters and measurements on primary overcurrent protection devices and ripple control units.

Transient Withstand Capability

CAUTION



Maximum input voltage for analog inputs

CAT I 300 Vrms, 400 Vpk; transient overvoltage 1.6 kVpk

CAT II 100 Vrms, 400 Vpk

with N2863A 10:1 probe: CAT I 600 V, CAT II 300 V (DC + peak AC)

with 10073C 10:1 probe: CAT I 500 Vpk, CAT II 400 Vpk

with 50Ω input: 5 Vrms

CAUTION



Do not exceed 5 Vrms in 50 Ω mode on the 2-channel models. Input protection is enabled in 50 Ω mode, and the 50 Ω load will disconnect if greater than 5 Vrms is detected. However, the input could still be damaged, depending on the time constant of the signal. The 50 Ω input protection mode only functions when the oscilloscope is powered on.

Environmental Conditions

Environment Indoor use only.

Ambient temperature Operating $-10\text{ }^{\circ}\text{C}$ to $+55\text{ }^{\circ}\text{C}$;
non-operating $-51\text{ }^{\circ}\text{C}$ to $+71\text{ }^{\circ}\text{C}$

Humidity Operating 95% RH at $40\text{ }^{\circ}\text{C}$ for 24 hr; non-operating
90% RH at $65\text{ }^{\circ}\text{C}$ for 24 hr

Altitude Operating to 4,570 m (15,000 ft); non-operating to
15,244 m (50,000 ft)

Overvoltage Category This product is intended to be powered
by MAINS that comply to Overvoltage Category II, which is
typical of cord-and-plug connected equipment.

Pollution Degree The 5000 Series Oscilloscope may be operated
in environments of Pollution Degree 2 (or Pollution Degree 1).

Pollution Degree Definitions Pollution Degree 1: No pollution or
only dry, non-conductive pollution occurs. The pollution has no
influence. Example: A clean room or climate controlled office
environment.

Pollution Degree 2. Normally only dry non-conductive pollution
occurs. Occasionally a temporary conductivity caused by
condensation may occur. Example: General indoor
environment.

Pollution Degree 3: Conductive pollution occurs, or dry,
non-conductive pollution occurs which becomes conductive due
to condensation which is expected. Example: Sheltered outdoor
environment.

Specifications

Please see the 5000 Series Oscilloscopes Data Sheet for complete, up-to-date specifications and characteristics.

To download a copy of the data sheet please visit: www.agilent.com/find/dso5000 and select **Library**, then select **Specifications**.

Or go to the Agilent home page at www.agilent.com and search for **5000 series oscilloscopes data sheet**.

To order a data sheet by phone, please contact your local Agilent office. The complete list is available at: www.agilent.com/find/contactus

Acknowledgements

RealVNC is licensed under the GNU General Public License. Copyright (C) 2002-2005 RealVNC Ltd. All Rights Reserved.

This is free software; you can redistribute it and/or modify it under the terms of the GNU General Public License as published by the Free Software Foundation; either version 2 of the License, or (at your option) any later version.

This software is distributed in the hope that it will be useful, but WITHOUT ANY WARRANTY; without even the implied warranty of MERCHANTABILITY or FITNESS FOR A PARTICULAR PURPOSE. See the GNU General Public License for more details. The license is located on the Agilent 5000 Series Oscilloscopes Programmer's Documentation CD-ROM.

RealVNC source code can be obtained from RealVNC or by contacting Agilent. Agilent will charge for the cost of physically performing the source distribution.

Contact us

Americas

Canada (877) 894-4414
Latin America 305 269 7500
United States (800) 829-4444

Asia Pacific

Australia 1 800 629 485
China 800 810 0189
Hong Kong 800 938 693
India 1 800 112 929
Japan 81 426 56 7832
Korea 080 769 0800
Malaysia 1 800 888 848
Singapore 1 800 375 8100
Taiwan 0800 047 866
Thailand 1 800 226 008

Europe

Austria 0820 87 44 11
Belgium 32 (0) 2 404 93 40
Denmark 45 70 13 15 15
Finland 358 (0) 10 855 2100
France 0825 010 700
Germany 01805 24 6333*
*0.14€/minute
Ireland 1890 924 204
Italy 39 02 92 60 8484
Netherlands 31 (0) 20 547 2111
Spain 34 (91) 631 3300
Sweden 0200-88 22 55
Switzerland (French)
44 (21) 8113811 (Opt 2)
Switzerland (German)
0800 80 53 53 (Opt 1)
United Kingdom 44 (0) 7004 666666
Other European countries:
www.agilent.com/find/contactus

Index

Symbols

- (-)Width measurement, 189
- (+)Width measurement, 189

Numerics

- 1*2 math function, 157
- 1-2 math function, 159
- 232, 87

A

- about oscilloscope, 87
- AC channel coupling, 62
- accessories, 16, 18, 19
- acquire, 212
- acquisition memory, 91
- acquisition mode, 209
 - averaging, 211, 212
 - high resolution, 210
 - normal, 210
 - peak detect, 210
- acquisition option
 - realtime, 214
- active probes, 40
- active serial bus, 220, 224, 229, 238
- addition, 159
- address with no ack condition, I2C trigger, 114
- Addresses softkey, 25
- adjust the handle, 20
- aliasing, FFT, 165
- Amplitude measurement, 194
- AMS, 87
- analog channel
 - probe attenuation, 64
- analog filters, adjusting, 165

- ASCII file format, 263
- attenuation factor, 58
- attenuation, probe, 64, 97
- Auto Increment, 261
- Auto trigger indicator, 49, 92
- auto trigger mode, 56, 92
 - Single, 55
- Auto? trigger indicator, 92
- automatic measurements, 73, 181
- automatic setup, 57
- AutoProbe, 48, 62
 - external trigger, 98
- AutoScale, 57
 - acquisition mode, 252
 - channels, 252
 - undo, 251
- autoscale key, 50
- Average measurement, 194
- averaging acquire mode, 211, 212

B

- bandwidth limit, 63
- bandwidth, oscilloscope, 214
- Base measurement, 194
- BIN file format, 263
- binary cursors, 175
- binary data (.bin), 275
- binary data file examples, 280
- binary data in MATLAB, 275
- binary data, example program for reading, 279
- bits, SPI trigger, 126
- blinking, 71, 153
- BMP file format, 262
- brightness of waveforms, 47
- Browser Web Control, 29

C

- calibrate probe, 64
- CAN decode
 - source channels, 228
- CAN frame counter, 231
- CAN serial decode, 226
- CAN Signals Menu, 227
- CAN totalizer, 231
- CAN trigger, 108
- Center, FFT, 168
- channel
 - bandwidth limit, 63
 - coupling, 62
 - invert, 63
 - on/off keys, 48
 - position, 61
 - probe units, 64
 - setup, 60
 - skew, 64
 - using, 60
 - vernier, 61
 - vertical sensitivity, 61
- channel pair, 214
- choosing values, 44
- cleaning, 274
- clear display, 205, 250
- clock, 78
- communicating with the oscilloscope, 24
- comparison of measurement results, 266
- compensate probes, 47
- compensating your probe, 38
- Config softkey, 25
- Configure softkey, 25
- connect probes, 35
- connect the dots, 206

Index

connection
to a PC, 27
connectivity, 24
control oscilloscope, 273
Controller softkey, 25
controls, front panel, 46, 51
conventions, 44, 45
Counter measurement, 187
counter, CAN frame, 231
counter, UART/RS232 frame, 245
coupling, channel, 62
crosstalk problems, 165
CSV file format, 262
cursor measurements, 72, 174

D

d/dt math function, 161
damage, shipping, 16
DC channel coupling, 62
default configuration, 88
default label library, 78
default setup, 88
delay knob, 67
Delay measurement, 190
delay time indicator, 66
delayed sweep, 67, 197
delete character, 261
delete file, 266
differentiate math function, 161
display, 50, 52
area, 52
clear, 205
intensity, 53
interpreting, 52
measurement line, 52
modes, 205
signal detail, 208
softkeys, 52
status line, 52
vectors, 207
display multiple acquisitions, 54
distortion problems, 165
DNS IP, 25

domain, 25
Domain softkey, 25
download Quick Help language file, 42
DSO, 4
duration trigger, 127
Duty cycle measurement, 187

E

edge triggering, 101
EEPROM data read, I2C trigger, 115
energy of a pulse, 163
Entry knob, 44, 45, 50
expand about, 61, 81, 203
expand about center, 81
expand about ground, 81
exporting waveform, 258
external memory device, 47
external trigger
input impedance, 99
probe attenuation, 97
probe settings, 97
probe units, 99
eye diagrams, 214

F

factory default configuration, 88
Fall time measurement, 188
FFT measurements, 165
FFT window, 169
file
save, recall, load, 266
file browser, save to, 259
file explorer, 259, 266
using, 268
file format
ASCII, 263
BIN, 263
BMP, 262
CSV, 262
PNG, 262
file keys, 48
file name, new, 260

firmware updates, 272
firmware version information, 28
Flat top window, 169
format
waveform, 262
frame trigger, I2C, 115, 116
Frequency measurement, 187
front-panel, 46, 51
overview, 43

G

gateway IP, 25
glitch trigger, 103
GPIB control, 273
graphic conventions, 45
graticule, 53
grid intensity, 53
ground level, 61

H

handle, 20
Hanning window, 169
HDTV trigger, 130
hex cursors, 175
HF Reject, 94, 246, 247
high-frequency noise rejection, 246, 247
high-resolution mode, 210
holdoff, 95
horizontal delay control, 49
horizontal menu/zoom key, 49
Horizontal section, 65
horizontal time/div control, 50
horizontal vernier, 66
host name, 28
hostname, 25
hysteresis, trigger, 247

I

I/O port configuration, 273
I/O softkey, 25
I2C serial decode, 217
I2C Signals Menu, 218

I2C trigger, 112
 idle serial bus, 220, 224, 229, 238
 Imped softkey, 62
 impedance
 external trigger, 99
 indeterminate state, 175
 infinite persistence, 54, 205, 248
 infrequent triggers, 214
 input impedance
 channel input, 62
 external trigger, 99
 input voltage, 36, 98
 instantaneous slope of a waveform, 161
 Integrate math function, 163
 intensity control, 47, 53
 invert, 63
 invert graticule colors, 263
 IP address, 25, 28

L

label key, 48
 label list, 77
 label list, loading from text file, 77
 labels, 74
 default library, 78
 LAN control, 273
 LAN interface, 25
 LAN Settings softkey, 25
 length control, 264
 length softkey, 264
 LF Reject, 247
 library, labels, 75
 licenses, 87
 LIN serial decode, 233
 LIN Signals Menu, 234
 LIN trigger, 118
 load file, 266
 Location, 259
 low-frequency noise rejection, 247
 LSS, 87

M

main horizontal mode, 65
 Main/Delayed, 49
 math
 1*2, 157
 1-2, 159
 differentiate, 161
 FFT, 165
 functions, 155
 integrate, 163
 measurements, 193
 multiply, 157
 offset, 156
 scale, 156
 subtract, 159
 units, 156
 math key, 48
 MATLAB binary data, 275
 Maximum measurement, 194
 maximum sample rate, 214
 measure keys, 50
 measurement category
 definitions, 285
 measurement definitions, 187
 measurement line, 52
 measurement thresholds, 184
 measurements, 73, 253
 MegaZoom III, 4
 memory depth, 54
 Menu/Zoom key, 49
 Minimum measurement, 194
 missing acknowledge condition, I2C
 trigger, 114
 Mode/Coupling key, trigger, 91
 model number, 28
 Modify softkey, 25
 Multiply math function, 157

N

navigate files, 266
 network configuration parameters, 28
 network status information, 28
 new label, 75

noise
 high-frequency, 246, 247
 low-frequency, 247
 noise reject, 94
 normal acquire mode, 210
 normal cursors, 174
 Normal trigger mode, 49, 56, 93

O

options, print, 255
 Overshoot measurement, 199
 overvoltage category, 287

P

palette, 264
 pan and zoom, 56, 202
 passive probes, 39
 password
 reset, 34
 set, 32
 pattern
 duration trigger, 127
 pattern trigger, 106
 SPI trigger, 126
 pattern trigger, 106
 PC connection, 27
 peak detect acquire mode, 210, 248
 Peak-peak measurement, 194
 Period measurement, 188
 persistence, infinite, 54
 Phase measurement, 191
 PNG file format, 262
 point-to-point connection, 27
 pollution degree, 287
 definitions, 287
 position, vertical, 61
 post-processing, 149
 power switch, 22, 47
 power-on, 22
 predefined labels, 75
 Preset, FFT, 168
 Preshoot measurement, 198

Index

Press to go, 259
print, 78
Print key, 48, 78
print options, 255
print screen, 254
printer
 USB, 254, 256
printers
 supported, 256
printing the display, 254
probe
 AutoProbe interface, 48
 calibrate, 64
probe attenuation, 64, 97
probe compensation, 47
probe factor, 58
probe units, 64, 99
probes, 19, 35
 active, 40
 compensating, 38
 passive, 39
pulse polarity, 103
pulse width trigger, 103

Q

qualifier, 104
Quick Help, 41
Quick Meas, 73, 181
Quick Print, 78
Quick Print key, 48, 254

R

random noise, 246
realtime acquire option, 214
recall waveform, 266
recall waveform and setup, 266
record length, 54
Rectangular window, 169
remote control, 24
remote display, web, 28
Remote Front Panel, 29
remote interface, 24

restart condition, I2C trigger, 114
return instrument for service, 274
Rise time measurement, 189
RMS measurement, 195
roll mode, 70
run controls, 49
Run/Stop key, 53
runt pulses, 188

S

sample rate, 5, 210, 214
 current rate displayed, 65
save
 browse to destination, 259
 formats, 262
 settings, 263
save file, 266
Save to, 259
save trace
 to scope memory, 265
 to USB, 265
save waveform
 to scope memory, 265
 to USB, 265
saver, screen, 80
saving data, 258
SCL, I2C trigger, 113
screen saver, 80
SDA, 112
SDA, I2C trigger, 113
SEC, 87
secure environment mode license, 87
selecting
 values, 44
Self Test, service, 86
serial clock, I2C trigger, 113
serial data, 112
serial data, I2C trigger, 113
serial decode, 216, 264
serial number, 28
service functions, 82
setup, automatic, 57
setup, default, 88

shipping damage, 16
shipping precautions, 274
single acquisition, 49, 55
Single key, 55
skew, channel, 64
slope trigger, 101
softkeys, 44, 50, 52
software updates, 272
Span, FFT, 167
specifications, 288
spectral leakage, FFT, 167
SPI serial decode, 221
SPI Signals Menu, 222, 240
SPI trigger, 121
square root, 172
stand-alone connection, 27
start acquisition, 49, 53
start condition, I2C, 114
status line, 52
status, User Cal, 84
Std Deviation measurement, 195
stop acquisition, 49, 53
stop condition, I2C, 114
subnet mask, 25
Subtract math function, 159
sweep speed vernier, 66
symbols, graphic, 45
sync polarity, TV trigger, 132

T

threshold
 channel measurements, 184
tilt for viewing, 20
time measurements, 186
time reference, 66
time reference indicator, 66
timebase, 65
Top measurement, 197
totalizer, CAN, 231
totalizer, UART/rs232, 245
trace
 save to scope memory, 265
 save to USB, 265

- transient withstand capability, 286
 - Trig'd trigger indicator, 93
 - Trig'd? trigger indicator, 93
 - trigger
 - coupling, 94
 - external, 97
 - HF Reject, 94
 - holdoff, 95
 - hysteresis, 247
 - mode, 91
 - mode/coupling, 91
 - noise reject, 94
 - source, 101
 - trigger controls, 48
 - trigger indicator
 - Auto, 92
 - Auto?, 92
 - Trig'd, 93
 - Trig'd?, 93
 - trigger mode
 - auto, 56, 92
 - normal, 56, 93
 - Trigger Out connector, 147
 - trigger type, 100
 - CAN, 108
 - duration, 127
 - edge, 101
 - glitch, 103
 - I2C, 112
 - LIN, 118
 - pattern, 106
 - pulse width, 103
 - slope, 101
 - SPI, 121
 - TV, 130
 - UART/RS232, 142
 - turn channel on, 48
 - TV trigger, 130
- U**
- UART totalizer, 245
 - UART/RS232 frame counter, 245
 - UART/RS232 license, 87
 - UART/RS232 serial decode, 239
- U**
- UART/RS232 trigger, 142
 - undo AutoScale, 57
 - units, math, 156
 - units, probe, 64, 99
 - unstable triggers, 214
 - updating software and firmware, 272
 - upload new firmware, 28
 - USB
 - CD device, 267
 - device port, 254
 - printer, 254
 - storage device numbering, 267
 - USB control, 273
 - USB ports, 47
 - USB, eject device, 47
 - USB0, 267
 - USB5, 267
 - user cal, 82
 - using vertical inputs, 60
 - Utility button, 25
 - utility key, 48
- V**
- values, choosing, 44
 - vectors, 206, 207
 - ventilation requirements, 22
 - vernier, channel, 61
 - vernier, sweep speed, 66
 - vertical expansion, 61
 - vertical inputs, 60
 - vertical position, 61
 - vertical position control, 47
 - vertical sensitivity, 48, 61
 - viewing signals, 208
 - viewing, tilt the instrument, 20
 - VISA connect string, 28
 - voltage measurements, 193
- W**
- warranted specifications, 288
 - warranty, 273
- W**
- waveform
 - printing, 254
 - recall, 266
 - save to scope memory, 265
 - save to USB, 265
 - saving and exporting, 258
 - waveform keys, 49
 - waveform reference point, 81
 - waveform save options, 263
 - Web browser, 24
 - web interface, 28
 - Width - measurement, 189
 - Width + measurement, 189
 - Window, FFT, 169
- X**
- X and Y cursors, 176
 - X at Max measurement, 189
 - X at Max on FFT, 186
 - X at Min measurement, 190
 - XY mode, 71, 150
- Y**
- Y and X cursors, 176
- Z**
- Z-axis blanking, 71, 153
 - zoom and pan, 56, 202
 - Zoom mode, 67

