



INSTRUCTION MANUAL

Models: N625, N630 & N650
Professional Infrared Thermometers

Table of Content

1. Product Introduction	3
1-1 Features	3
1-2 Applications	3
2. Safety Information	4
2-1 Cautions	4
2-2 Safety Symbols	4
3. Specifications	5
4. Operation Instructions	6
4-1 Quick Start	6
4-2 Unit Diagram	6
4-3 LCD Display	7
4-4 °C/°F Switch	7
4-5 Advanced Functions	8
4-6 Remarks	9
5. Techniques of IR Thermometer	10
5-1 Field of View Ratio	10
5-2 Emissivity	11
6. Maintenance	11
7. Emissivity Table	12
8. Service Information	13
9. Warranty Information	14

1. Product Introduction

Congratulation on your purchase of a Anaheim Scientific infrared thermometer. This Infrared Thermometer is a non-contact infrared temperature measuring instrument. Some features include a 4 digits backlit LCD, scan/hold/auto function (auto not available on N625) and auto power off (approx. 6 seconds). To measure a temperature, point the unit at the object, pull the measuring trigger. Make sure the target area is larger than the unit's spot size (see section 5 on page 10 for distance to spot information).

1-1 Features

- Emissivity adjustable from 0.1 to 1.00 in 0.01 steps (model N625 has a fixed Emissivity of 0.95)
- Ultra low power consumption in shutdown mode
- Two year warranty
- Selectable On/Off laser sighting
- Backlit LCD display
- °C or °F Selectable
- Temperature data storage (not available on model N625)
- 10 Points of measurement memory (not available on N625)
- Max/Min/Avg/ ΔT Function (not available on model N625)
- Audible alarms (not available on model N625)

1-2 Applications

- Electrical troubleshooting
- Automotive repair and maintenance
- Air conditioning testing and maintenance
- Science experiments
- Manufacturing processes of semiconductor technologies
- Measure terminals on circuits
- Food safety and processing
- Perform HVAC energy audits

2. Safety Information

Read the following safety information carefully before attempting to operate or service the meter. Only qualified personnel should perform repairs or servicing not covered in this manual.

LASER WARNING NOTE!



Do not aim laser spot directly at human eyes. Do not aim this product in any direction where people will be present.

2-1 Cautions!

- **DO NOT** submerge the products mentioned in this manual in water or any other types of liquids.
- This product is not designed for use in medical applications. The product can only be used to measure body temperature simply for reference.
- Keep a safe distance from any potentially dangerous items to be measured.

2-2 Safety Symbols



Dangerous, refer to this manual before using the meter.

 Conforms to requirements of European Union and European Free Trade Association (EFTA).



Battery level is low.



Don't dispose this product as unsorted municipal waste.

This instrument conforms to the following standards:

EN61326: Electrical equipment for measurement, control and laboratory use.

IEC61000-4-2: Electrostatic discharge immunity test.

IEC61000-4-3: Radiated, radio-frequency, electromagnetic field immunity test.

IEC61000-4-8: Power frequency magnetic field immunity test.

Tests were conducted using a frequency range of 80-1000MHz with the instrument in three orientations. The average error for the three orientations is $\pm 0.5^{\circ}\text{C}$ ($\pm 1.0^{\circ}\text{F}$) at 3V/m throughout the spectrum. However, between 781-1000MHz at 3V/m, the instrument may not meet its stated accuracy.

3. Specifications

MODEL

N625

N630

N650

Distance/Spot Ratio	12:1		
Temperature Range	-25~999°F (-32~535°C)		-58~1830°F (-50~999°C)
Accuracy (Assumes Operation Ambient Temp. of 23°C/73°F)	From -50~20°C (-58~4°F) = ±3°C (±5°F)		
	From -20~100°C (-4~212°F) = ±2°C (±3°F)		
	From 100~999°C (212~1830°F) = ±2%		
Thermopile	5~14μm	8~14μm	
Repeatability	±1°C (±2°F)		
Resolution	0.1°C (0.1°F)	1°C (1°F)	
Response Time	500 ms.		
Operation Temp	0~50°C (32~122°F), 10~90% RH		
Auto Power Off	Automatically after approx. 6 sec.		
Emissivity	0.95	Adj. 0.1~1.0	Adj. 0.1~1.0
°C/°F Switchable	YES	YES	YES
Backlight	YES	YES	YES
Laser Sight Switchable	YES	YES	YES
Max/Min/Avg/ΔT	NO	YES	YES
Auto-Measuring	NO	YES	YES
10 point memory	NO	YES	YES
Audio Alarm	NO	YES	YES
Battery Type	9V, 006P, IEC6F22, NEDA1604		
Dimensions	170 x 133 x 45mm (6.69" x 5.23" x 1.77")		
Weight	187g Approx.		

Included Accessories: 9V Battery, Instruction Manual, Carrying Case
Specifications and information is subject to change without notice.

For the most current and up-to-date product information please
visit www.anaheimscientific.com

4. Operation of Instrument

4-1 Quick Start

To measure a temperature, point the unit at the target you want to measure, pull the trigger and hold on till the end of shot. In **SCAN** mode, the LCD displays either the current temperature in Celsius or Fahrenheit. The unit will **HOLD** the last reading for about 6 seconds after the trigger is released; the word **HOLD** appears on LCD. Be sure to consider the target area inside the angle of vision of this instrument (see section 5 on page 10). The single spot of laser is used for aiming only.

4-2 Unit Diagram

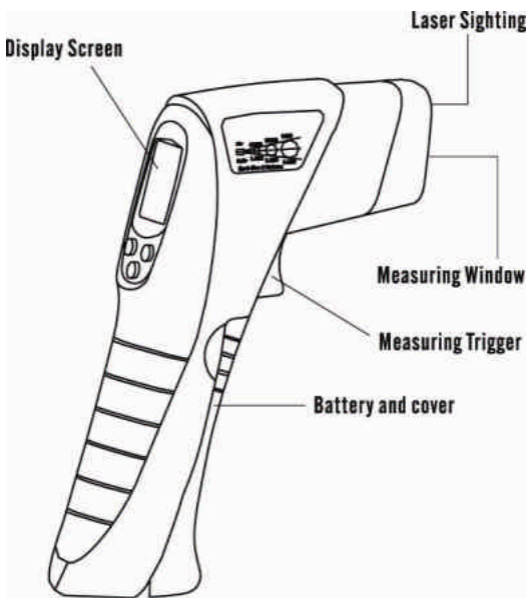

4-3 LCD Display

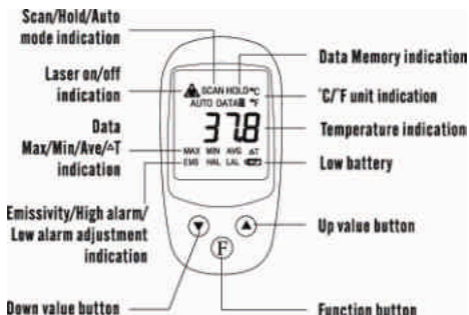

4-4 °C/°F Switch

The unit is powered by 9V battery and displays temperatures in either °C or °F. The user has to replace the battery when the battery voltage drops below the voltage for reliable operation and at the same time the low battery symbol  will appear.

To change the 9V battery, pull open the unit's battery cover. Change the 9V battery with a new one and push the battery cover back to the closed position.

Note: Not all models have all functions shown in diagrams.

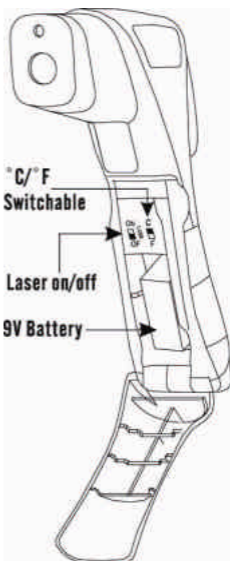

4-5 Advanced Functions (models N630 & N650)

Operating more advanced functions is done by pressing the "F" button. The sequential operations and the corresponding explanations are shown in the following flow-chart.

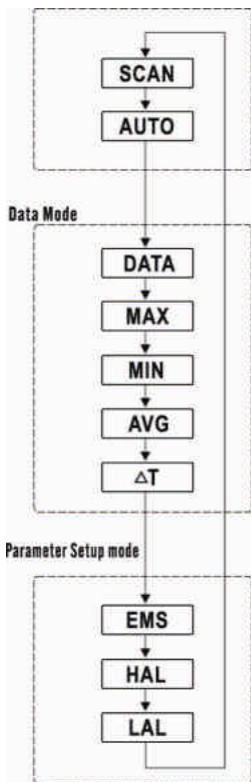

- Scan and display the temperature during measurement.

- Continuously measure and display the temperature without pulling the measuring trigger. Activate the "Auto" function by pressing the "F" button and pulling the trigger at the same time.

- Activate the data record function when pulling the trigger and recall the stored data by using ▲ or ▼ button. (Note: While triggering to record, the new data will replace the existing data on the next storage space.)

- The maximum temperature within one shot measuring.

- The minimum temperature within one shot measuring.

- The average temperature within one shot measuring.

- The difference between the highest and lowest temperatures within one shot measuring.

- Adjustable emissivity for more accuracy on all surfaces.

- Highest alarm temperature setting.

- Lowest alarm temperature setting.

("The parameters are adjusted by using ▲ or ▼ buttons.)

4-6 Remarks

For more details on user operation, please read the following contents.

- No matter whether you push the measuring trigger or not, when the unit's power is on, you can change the functions or adjust the parameters.
- To avoid accidental operations, the setup of functions can be performed, only after the unit is powered on by the measuring trigger.
- To avoid careless touch, some power management designs have to be implemented.
 - **Auto** function allows you continuously measure the target temperature and you don't have to keep pulling the measuring trigger all the time.
 - **Auto** function can be only setup when both the measuring trigger and the F function button are pressed at the same time.
 - The unit is totally power off, no more standby current when storage, to keep battery last much longer.

5. Techniques of Infrared (IR) Thermometers

5-1 Field of View (FOV) Ratio = Distance to Spot (D:S) Ratio

The field of view is the angle of vision at which the instrument operates, and is determined by the optics of the unit. The FOV is the ratio of the distance from the target to the target diameter. The smaller the target, the closer you should be to it. When the target diameter is small, it is important to bring the thermometer closer to the target to insure that only the target is measured, excluding the surroundings. Note: Be careful not to be close enough to a heat source to cause harm to you or to cause damage to meter.

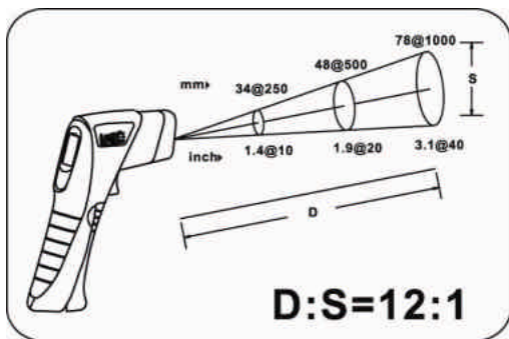

Approximate examples of distance to spot are shown in the diagram above. At a distance of 12 inches the spot diameter will be 1 inch.

5-2 Emissivity

Emissivity is the ability of an object to emit or absorb IR energy. Perfect emitters have an emissivity of 1, emitting 100% of incident energy. An object with an emissivity of 0.8 will absorb 80% and reflect 20% of the incident energy. Emissivity is defined as ratio of the energy radiated by an object at a given temperature to the energy emitted by a perfect radiator at the same temperature. All values of emissivity fall between 0.1 and 1.0.

(Note: Please refer to the Emissivity Table on the next page.)

Noncontact temperature sensors measure IR energy emitted by the target, have fast response, and are commonly used to measure moving and intermittent targets, targets in a vacuum, and targets that are inaccessible due to hostile environments, geometry limitations, or safety hazard. The cost is relatively high, although in some cases is comparable to contact devices.

6. Maintenance

Cleaning the lens: Blow off loose particles using clean low pressure compressed air. Gently brush remaining debris away with a clean and soft camel hair brush. Carefully wipe the surface with a moist cotton swab. The swab should be slightly moistened with clean water.

NOTE:

DO NOT use solvents to clean the lens.

Cleaning the housing:

Use soap and water on a damp sponge or soft cloth.

7. Emissivity Table

Material	Temp °C/F	Emissivity
Gold(pure highly polished)	227/440	0.02
Aluminum foil	27/81	0.04
Aluminum disc	27/81	0.18
Aluminum household(flat)	23/73	0.01
Aluminum (polished plate 98.3%)	227/400	0.04
	577/1070	0.06
Aluminum(rough plate)	26/78	0.06
Aluminum(oxidized @599°C)	199/390	0.11
	599/1110	0.19
Aluminum surfaced roofing	38/100	0.22
Tin(bright tinned iron sheet)	25/77	0.04
Nickel wire	187/368	0.1
Lead(pure 99.95-unoxidized)	127/260	0.06
Copper	199/390	0.18
	599/1110	0.19
Steel	199/390	0.52
	599/1110	0.57
Zinc galvanized sheet iron(bright)	28/82	0.23
Brass(highly polished):	247/476	0.03
Brass(hard rolled-polished w/lines):	21/70	0.04
Iron galvanized(bright)	-	0.13
Iron plate(completely)	20/68	0.69
Rolled sheet steel	21/71	0.66
Oxidized iron	100/212	0.74
Wrought iron	21/70	0.94
Molten iron	1299-1389/3270-2550	0.29
Copper(polished)	21-117/70-242	0.02
Copper(scraped shiny not mirrored)	22/72	0.07
Copper(Plate heavily oxidized)	25/77	0.78
Enamel(white fused on iron)	19/66	0.9
Formica	27/81	0.94
Frozen soil	-	0.93
Brick(red-rough)	21/70	0.93
Brick(silica-unglazed rough)	1000/1832	0.8
Carbon(T-carbon 0.9% ash)	127/260	0.81
Concrete	-	0.94
Glass(smooth)	22/72	0.94
Granite(polished)	21/70	0.85
Ice	0/32	0.97
Marble(light gray polished)	22/72	0.93
Asbestos board	23/74	0.96
Asbestos paper	38/100	0.93
	371/700	0.95
Asphalt(paving)	4/39	0.97

8. Service Information

Warranty Service: Please return the product in the original packaging with proof of purchase to the address below. Clearly state in writing the performance problem and return any leads, probes, connectors and accessories that you are using with the device.

Non-Warranty Service: Return the product in the original packaging to the address below. Clearly state in writing the performance problem and return any leads, probes, connectors and accessories that you are using with the device. Customers not on open account must include payment in the form of a money order or credit card. For the most current repair charges please visit www.anaheimscientific.com and click on "service/repair".

Return all merchandise to Anaheim Scientific with pre-paid shipping. The flat-rate repair charge for Non-Warranty Service **does not** include return shipping. Return shipping to locations in North America is included for Warranty Service only. For overnight shipments and non-North American shipping fees please contact Anaheim Scientific.

Anaheim Scientific
22820 Savi Ranch Parkway
Yorba Linda, CA 92887
www.anaheimscientific.com
714-921-9095

Include with the returned instrument your complete return shipping address, contact name, phone number and description of problem.

9. Limited Two-Year Warranty

Anaheim Scientific warrants to the original purchaser that its products and the component parts thereof, will be free from defects in workmanship and materials for a period of two years from date of purchase from an authorized Anaheim Scientific distributor.

Anaheim Scientific will, without charge, repair or replace, at its option, defective product or component parts. Returned product must be accompanied by proof of the purchase date in the form of a sales receipt.

To obtain warranty coverage in the U.S.A., this product must be registered by completing the warranty registration form on www.anaheimscientific.com within fifteen (15) days of purchase.

Exclusions: This warranty does not apply in the event of misuse or abuse of the product or as a result of unauthorized alterations or repairs. The warranty is void if the serial number is altered, defaced or removed.

Anaheim Scientific shall not be liable for any consequential damages, including without limitation damages resulting from loss of use. Some states do not allow limitations of incidental or consequential damages. So the above limitation or exclusion may not apply to you.

This warranty gives you specific rights and you may have other rights, which vary from state-to-state.

Anaheim Scientific
22820 Savi Ranch Parkway
Yorba Linda, CA 92887
www.anaheimscientific.com
714-921-9095



Anaheim Scientific

22820 Savi Ranch Parkway

Yorba Linda, CA 92887

U.S.A.

www.anaheimscientific.com

Printed in Taiwan / Ver. 1.0/0606

© 2006 Anaheim Scientific Corporation