

Federal Communications Commission Statement (Class A)



NOTE- This equipment has been tested and found to comply with the limits for a Class A digital device, pursuant to Part 15 of the FCC Rules. These limits are designed to provide reasonable protection against harmful interference in a residential installation. This equipment generates uses and can radiate radio frequency energy and, if not installed and used in accordance with the instructions, may cause harmful interference to radio communications. However, there is no guarantee that interference will not occur in a particular installation. If this equipment does cause harmful interference to radio or television reception, which can be determined by tuning the equipment off and on, the user is encouraged to try to correct the interference by one or more of the following measures:

- Reorient or relocate the receiving antenna.
- Increase the separation between the equipment and receiver.
- Connect the equipment into an outlet on a circuit different from that to which the receiver is connected.
- Consult the dealer or an experienced radio/television technician for help.

Class A ITE:

Class A ITE is a category of all other ITE which satisfies the class A ITE limits but not the class B ITE limits. Such equipment should not be restricted in its sale but the following warning shall be included in the instructions for use:

Warning - This is a class A product. In a domestic environment this product may cause radio interference in which case the user may be required to take adequate measures.

CE Class A (EMC)



This product is herewith confirmed to comply with the requirements set out in the Council Directives on the Approximation of the laws of the Member States relating to Electromagnetic Compatibility Directive 2004/108/EEC.

Warning - This is a Class A product. In a domestic environment this product may cause radio interference in which case the user may be required to take adequate measures to correct this interference.

DISCLAIMER

No warranty or representation, either expressed or implied, is made with respect to the contents of this documentation, its quality, performance, merchantability, or fitness for a particular purpose. Information presented in this documentation has been carefully checked for reliability; however, no responsibility is assumed for inaccuracies. The information contained in this documentation is subject to change without notice.

In no event will AVerMedia be liable for direct, indirect, special, incidental, or consequential damages arising out of the use or inability to use this product or documentation, even if advised of the possibility of such damages.

Touchboards

205 Westwood Ave, Long Branch, NJ 07740
Phone: 866-94 BOARDS (26273) | (732)-222-1511 | Fax: (732)-222-7088
E-mail: sales@touchboards.com | Site: www.touchboards.com

TRADEMARKS

AVerVision is registered trademarks of AVerMedia Information, Inc. IBM PC is a registered trademark of International Business Machines Corporation. Macintosh is a registered trademark of Apple Computer, Inc. Microsoft is a registered trademark and Windows is a trademark of Microsoft Corporation. All other products or corporate names mentioned in this documentation are for identification and explanation purposes only, and may be trademarks or registered trademarks of their respective owners.

COPYRIGHT

© 2009 by AVerMedia Information, Inc. All rights reserved. No part of this publication may be reproduced, transmitted, transcribed, stored in a retrieval system, or translated into any language in any form by any means without the written permission of AVerMedia INFORMATION, Inc.



THE MARK OF CROSSED-OUT WHEELED BIN INDICATES THAT THIS PRODUCT MUST NOT BE DISPOSED OF WITH YOUR OTHER HOUSEHOLD WASTE. INSTEAD, YOU NEED TO DISPOSE OF THE WASTE EQUIPMENT BY HANDING IT OVER TO A DESIGNATED COLLECTION POINT FOR THE RECYCLING OF WASTE ELECTRICAL AND ELECTRONIC EQUIPMENT. FOR MORE INFORMATION ABOUT WHERE TO DROP OFF YOUR WASTE EQUIPMENT FOR RECYCLING, PLEASE CONTACT YOUR HOUSEHOLD WASTE DISPOSAL SERVICE OR THE SHOP WHERE YOU PURCHASED THE PRODUCT.

Remote Control Battery Safety Information

- Store batteries in any cool & dry place.
- Do not dispose used batteries in domestic waste. Dispose batteries at special collection points or return to stores if applies.
- Remove the batteries if they are not in use for long period of time. Battery leakage and corrosion can damage the remote control, dispose batteries safely.
- Do not mix and use old and new batteries.
- Do not mix and use different types of batteries: alkaline, standard (carbon-zinc) or rechargeable (nickel-cadmium).
- Do not dispose batteries in a fire.
- Do not attempt to short circuit the battery terminals.

Table of Contents

Introduction	1
Package Contents	1
Optional Accessories.....	2
AVerVision CP135 Parts.....	3
Technical Specifications.....	4
Making the Connections.....	5
Connecting the Power Adapter	6
Connecting a TV	6
Connecting a CRT/LCD/MAC Display Monitor or LCD/DLP Projector	7
Connecting a Computer	7
Connecting a Computer via USB	8
Connecting to a Microscope	8
Setting Up AVerVision CP135.....	9
Camera Head	9
LED Light	9
Infrared Sensor	9
Flexible Gooseneck and Arm	10
Anti-glare Sheet	10
Using the Infrared Remote Control	11
Touch Button Control Panel.....	15
OSD Navigation Tree.....	17
Menu Functions.....	18
Transferring the Captured Image to PC.....	22
Troubleshooting	22
Limited Warranty	23

Introduction

Thank you for purchasing the AVerMedia® AVerVision CP135. This document camera displays documents, negatives, transparencies and 3D objects onto a TV, LCD or DLP projector making presentations a snap.

AVerVision CP135 is an ideal presentation tool for business, academic, medical and the scientific community.

AVerMedia

Package Contents

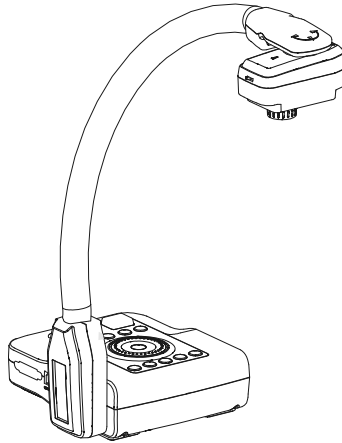

AVerMedia® AVerVision CP135

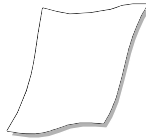

Anti-glare Sheet

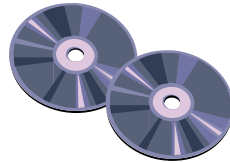

Software & Manual CD

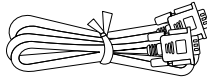

RGB Cable



USB Cable



Remote Control
(batteries included)

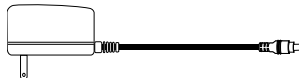

Power Adapter

* The power adapter will vary depending on the standard power outlet of the country where it is sold.

Optional Accessories

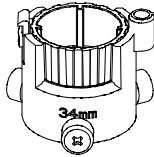

34mm Microscopic Adapter

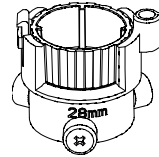

28mm Microscopic Adapter

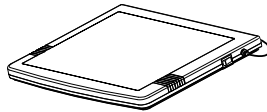

Light Box

AVerVision CP135 Parts

The illustrations below identify the parts of AVerVision CP135.

- (1) Camera head
- (2) LED light
- (3) Camera lens
- (4) LED light switch
- (5) IR sensor
- (6) Control panel
- (7) Right panel
- (8) Gooseneck
- (9) Rear panel
- (10) Left panel
- (11) Label slot

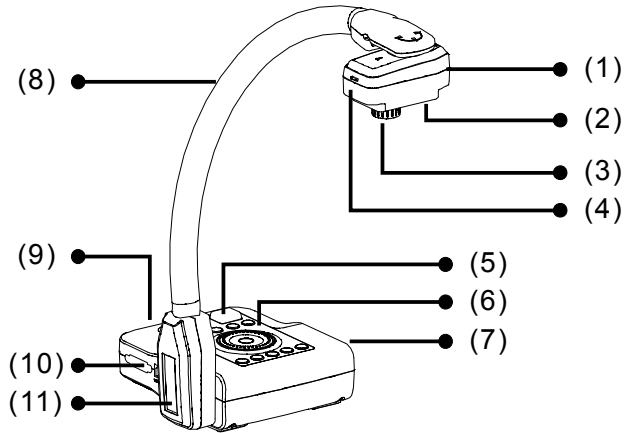

- (12) DC 12V port
- (13) Antitheft slot
- (14) Camera head holder

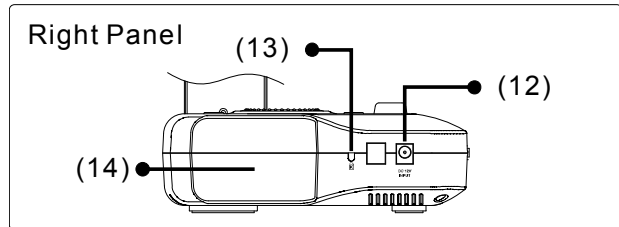

- (15) S-Video output port
- (16) Composite video output port
- (17) RGB input port
- (18) RGB output port

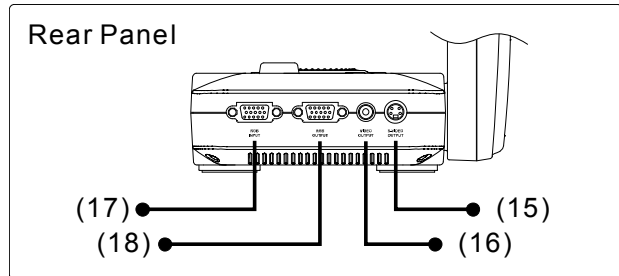

- (19) TV-RGB switch
- (20) USB port

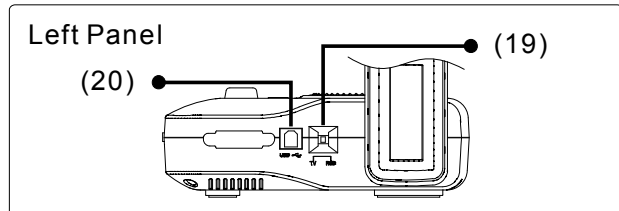

Technical Specifications

Image

Sensor	1/2" Progressive Scan CMOS
Pixel Count	3.2 mega pixels
Frame Rate	24 fps (max.)
White Balance	Auto / Manual
Exposure	Auto / Manual
Image mode	Text / Graphics / High Frame
Effect	Color / B/W / Negative
Analog RGB output	HD 720P; XGA 60 Hz; SVGA 60 Hz; VGA 60 Hz
Image Capture	Up to 80 Frames

Optics

Lens	F3.0; f _l =9.6mm
Focusing	Manual
Shooting Area	330mm x 248mm (max.)
Zooming	2X AVERZOOM, 8X Digital Zoom

Power

Power Source	DC 12V, 100-240V, 50-60Hz
Consumption	18 Watts (lamp off); 20 Watts (lamp on)

Lighting

Lamp Type	LED light
-----------	-----------

Input/Output

RGB Input	15-Pins D-sub (VGA)
RGB Output	15-Pins D-sub (VGA)
S-Video	Mini-DIN Jack
Composite Video	RCA Jack
USB	USB2.0
DC 12V Input	Power Jack

Dimension

Operating	480 mm x 180mm x 504mm
Folded	340mm x 230mm x 61mm
Weight	2.4 kg (about 5.3 lb)

Making the Connections

The ports on the rear, left and right panel of CP135 enable you to connect the unit to a computer, graphics display monitor or LCD/DLP projector, TV or other device. Illustrated below are the ports that are located at the rear, left and right panel of CP135 with their corresponding labels.

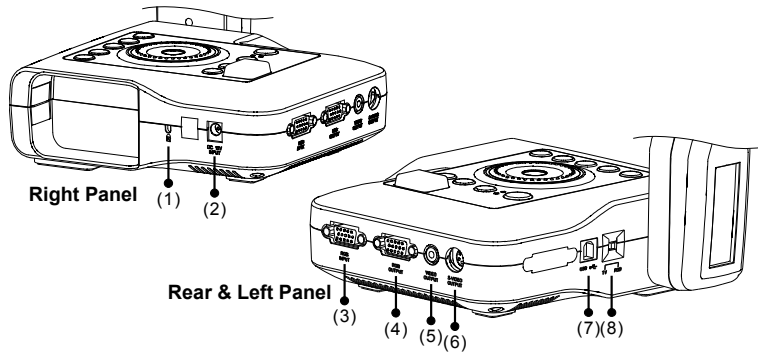

Port	Description
(1) Antitheft Slot	Attach a Kensington compatible security lock or antitheft device.
(2) DC 12V Input	Connect the power adapter into this port.
(3) RGB INPUT	Input the signal from a computer or other sources and pass it through to the RGB Output port only. Connect this port to the RGB/VGA output port of the computer.
(4) RGB OUTPUT	Output the signal from the camera, RGB input port, or the captured images from the memory on a CRT/LCD/MAC monitor or LCD/DLP projector.
(5) VIDEO OUTPUT (RCA/Composite)	Output the signal from the camera or the captured images from the memory on TV or Video equipment. Connect this port to the VIDEO input port of a TV or video equipment.
(6) S-VIDEO OUTPUT	Output the signal from the camera or the captured images from the memory on TV or Video equipment. Connect this port to the S-VIDEO input port of a TV or video equipment.
(7) USB	Use CP135 as a USB Camera or transfer the captured images from CP135 memory to PC. Connect this port to the USB port of the computer.
(8) TV-RGB switch	Switch to output display video either from Video and S-VIDEO, or RGB output port.

Connecting the Power Adapter

Connect the power adapter to a standard 100V~240V AC power source.

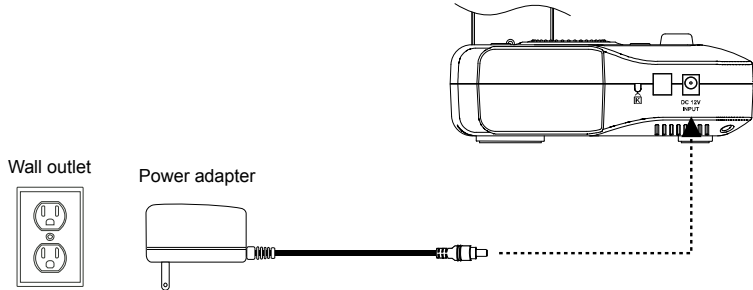

Connecting a TV

Locate the VIDEO, S-VIDEO or SCART RGB input port of the TV or Video equipment (i.e., VCR) to record your presentation on a videotape and connect it to S-VIDEO or VIDEO OUTPUT port of CP135.



- For better video quality, we strongly suggest using S-VIDEO connection.
- Make sure the TV/RGB switch is set to TV.

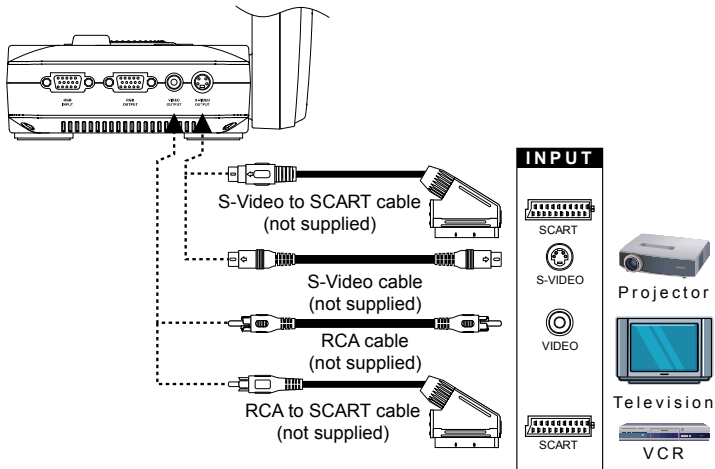

Connecting a CRT/LCD/MAC Display Monitor or LCD/DLP Projector

Locate the RGB (VGA) input port of the graphics display device and connect it to RGB OUTPUT port of CP135.



Make sure the TV/RGB switch is set to RGB.

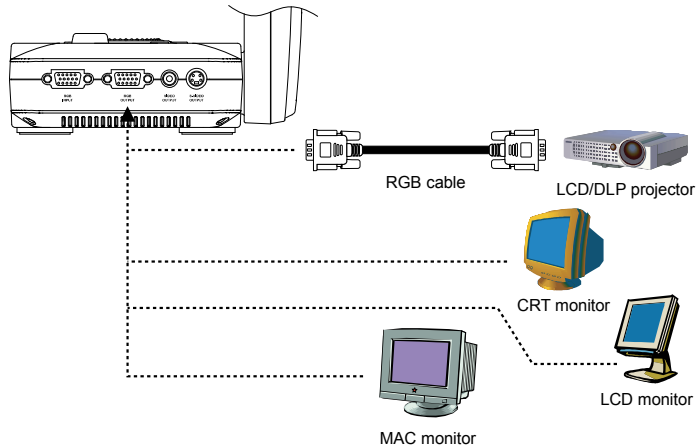

Connecting a Computer

Locate the RGB (VGA) output port of the computer or laptop to display your PC presentation on screen and connect it to RGB INPUT port of CP135. The video signal from the RGB INPUT port is streamed to RGB OUTPUT port, and displayed on the screen.



- To display computer image, press Camera/PC button on the control panel or remote control to switch CP135 to PC mode.
- For laptop to output display image, use the keyboard command (FN+F5) to switch between the display modes. For different command, please refer to your laptop manual.

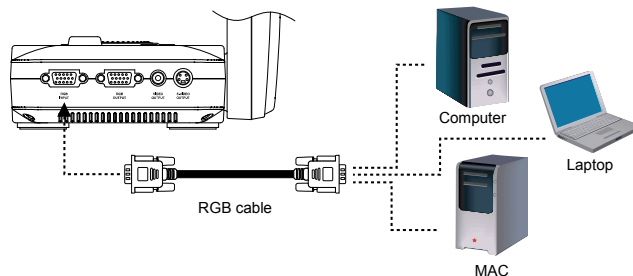

Connecting a Computer via USB

Locate the USB port of the computer or laptop and connect it to USB port of CP135. This enables you to use CP135 as a USB Camera and to transfer the captured images from the memory and to computer. Also see "Transfer Image from AVerVision CP135 to PC".

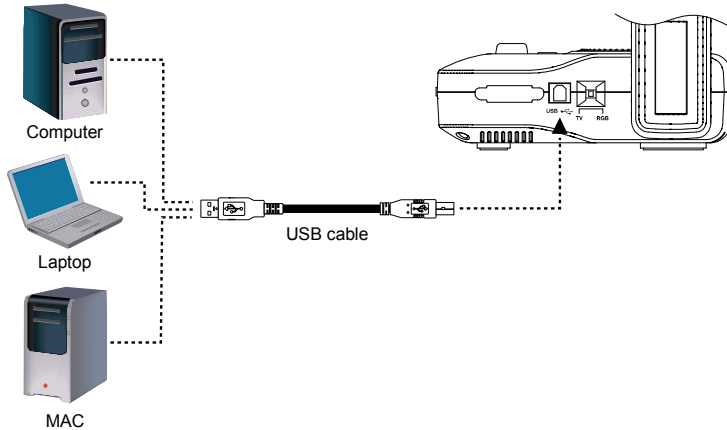

Connecting to a Microscope

Connecting the CP135 to a microscope enables you to examine microscopic objects on a big screen without straining your eyes.

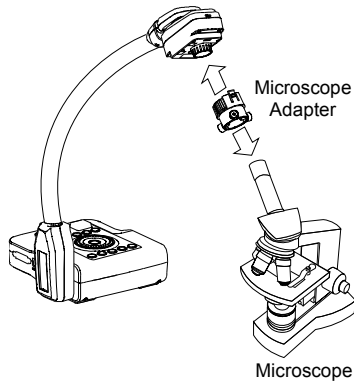

Setting Up AVerVision CP135

This section provides useful tips on how to adjust the CP135 to meet your needs.

Camera Head

The camera head can be turned 90° to the left and right. You can also manually adjust the focus from the focus ring to improve the quality of the pictures.

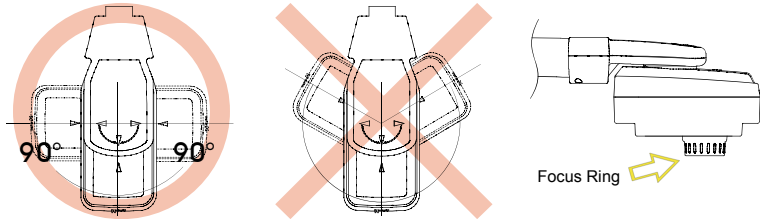

LED Light

The LED light provides white light and is best used when presenting in low light conditions.

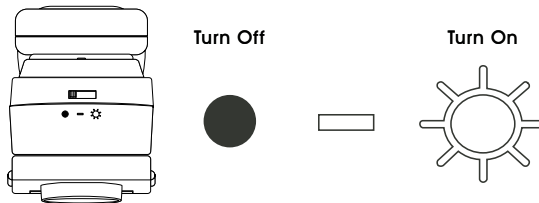

Infrared Sensor

Aim the remote control at the infrared sensor to operate the unit.

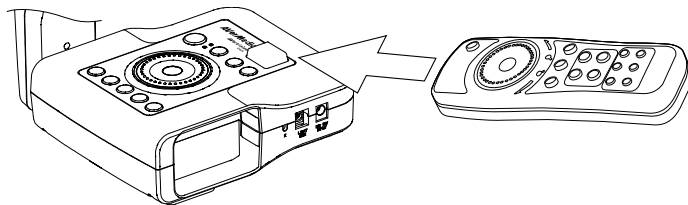

Flexible Gooseneck and Arm

The flexible gooseneck and arm design allows you to position the camera head from any angle.



When positioning the camera head in upright position, press **REVERSE** on the remote control to rotate the image 180°. You may also rotate the image 180° in OSD menu. Just press **MENU**, select **REVERSE** in IMAGE menu list, and then press **ENTER** to turn on/off image reverse.

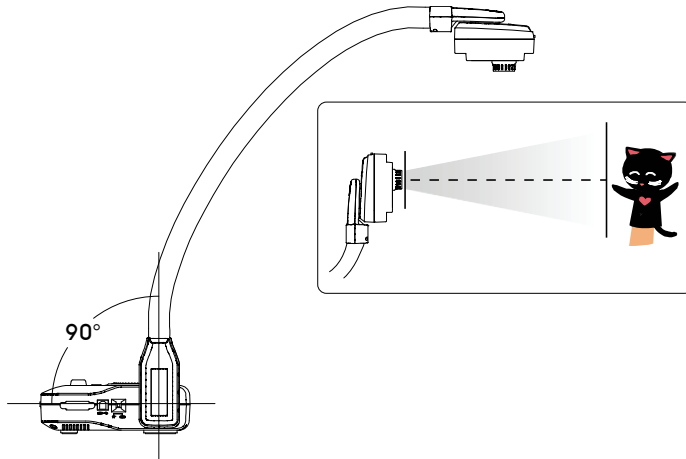

Anti-glare Sheet

The anti-glare sheet is a special coated film that helps eliminate any glare that maybe encountered while displaying very shiny objects or glossy surfaces such as magazines and pictures. To use, simply place the anti-glare sheet on top of the shiny document to reduce reflected light.

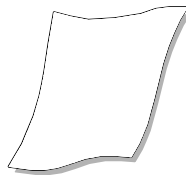

Using the Infrared Remote Control

Use the CP135 Remote Control to enhance your presentation by having the ability to switch between three (3) presentation modes and access various features. To use the remote control, first insert the batteries (2 “AAA” size batteries are provided) into the battery compartment at the back of the remote. Use the figure and descriptions below as a reference for remote control functions.

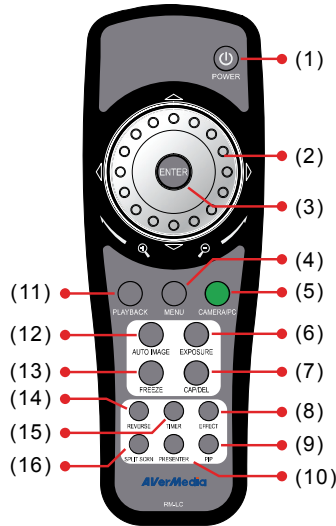

Name	Function
(1) POWER	Turn the unit on/off.
(2) Shuttle Wheel	<ul style="list-style-type: none"> - Turn the shuttle wheel clockwise to zoom in and counter-clockwise to zoom out the image in Camera and Playback mode only. When it reaches the maximum AVERZOOM level of about 200%, you can still continue to digitally zoom in the image up to 1600%. Press ENTER to return to normal view (100%). - Press the shuttle wheel ▲, ▼, ◀, & ▶ to pan the image while in zoom in mode, to make a selection on 16-thumbnail images or move to the next or previous single full screen preview in Playback mode, or to make a selection and adjustment on the OSD main-menu and sub-menu (See Menu Functions for more details).
(3) ENTER	Make a selection in Playback mode and OSD menu. Use this to quick zoom to 200% or back to 100% in Camera mode only.
(4) MENU	Pull up and exit the OSD main-menu and sub-menu.

Name	Function
(5) CAMERA/PC	<p>Switch between Camera and PC mode.</p> <ul style="list-style-type: none"> - Camera mode displays the video signal from the built-in camera. - PC mode displays the video signal from the RGB INPUT port of CP135.
(6) EXPOSURE	<p>Select to automatically or manually adjust the exposure. This adjusts the camera exposure to determine how much light is required.</p>
(7) CAP/DEL	<ul style="list-style-type: none"> - Capture a still image in Camera mode. The captured image is saved in the memory and can store up to 80 images. The image size can be saved either in 1024 x 768 (default) or 2016 x 1520 pixels. <p>If the Capture setting is in Continuous mode, use CAP/DEL button to start and stop successive still image capture. To stop continuous capture, press CAP/DEL button when "SAVE" message in the status box at the lower right corner of the screen disappear.</p> <p>To set the image size of your choice, press MENU, select CAPTURE in IMAGE menu list, press ENTER, select IMG SIZE, press ENTER, use ▲ and ▼ to make a selection, and press ENTER to save the setting.</p> <ul style="list-style-type: none"> - Remove the selected picture from the built-in memory permanently in Playback mode.
(8) EFFECT	<p>Convert and display the image in BW, Negative or Color in Camera and Playback mode only.</p>
(9) PIP	<p>Show a thumbnail size playback screen at the corner of the screen to view the captured image from the memory in Camera mode.</p> <p>Use ◀ or ▶ to move to the previous or next image and ENTER to view the image in full screen and press ENTER again to go back to PIP mode.</p> <p>To move the thumbnail playback screen to different corners or close, press PIP button repeatedly. You may also press CAMERA/PC to exit PIP mode and switch to Camera mode.</p>
(10) PRESENTER	<p>Select to turn on/off AVERBOX or AVERVISOR. Only one feature can be used at a time.</p> <p>In the PRESENTER menu, use ▲ and ▼ to select between AVERBOX or AVERVISOR, and press ENTER to turn on/off the selected feature. Then press MENU to close menu or execute the turned on feature. To exit AVerBox or AVerVisor mode, press CAMERA/PC to switch to Camera mode.</p>

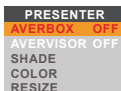

Name **Function**

(10) PRESENTER - AVerBox overlays a frame on the presentation screen. Selecting **SHADE** changes the opacity of the area outside the box from 0%, 50% and 100%, **COLOR** to change the frame color from red, green and blue, and **RESIZE** to change the size of the frame.
 To resize the frame, press the shuttle wheel ▲, ▼, ◀, & ▶ then press **ENTER** when done resizing. To move the frame around the presentation screen, use the shuttle wheel ▲, ▼, ◀, & ▶.

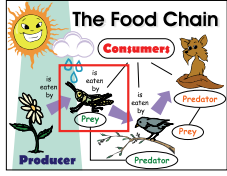

- AVerVisor covers part of the presentation screen. The upper part of the presentation screen is slightly exposed when it is being called each time. To expose part of the covered area, press the shuttle wheel ▲, ▼, ◀, & ▶. Select **SHADE** to change the darkness of the shaded area between 50% or 100%.

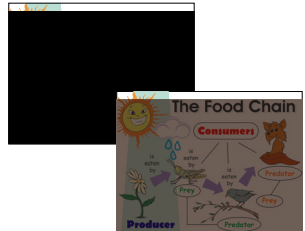

(11) PLAYBACK View the captured image from the memory in 16-thumbnail images.

Use ▲, ▼, ◀, & ▶ to make a selection and **ENTER** to view the selected image in full screen. To zoom in and out the image, turn the shuttle wheel clockwise and counter-clockwise.

To start slide show, press **MENU**, select **START** and press **ENTER** to begin and end. Select **INTERVAL** to set the display time interval between frames in second.

To change the slide show time interval, select **INTERVAL**, press **ENTER** and the bar will turn red, use ◀ & ▶ to increase and decrease the value, and then press **ENTER** to save the setting and the bar will turn white.



Name	Function
(12) AUTO IMAGE	Automatically adjust and set the white balance and exposure setting.
(13) FREEZE	Toggle to pause or resume the camera.
(14) REVERSE	Rotate the image by 180° in Camera mode only.
(15) TIMER	<p>Set/start/pause/resume the timer in TIMER menu. The timer will automatically count up after count down reaches zero to show the elapsed time. The timer continues to run even when you switch to different modes.</p> <p>In TIMER menu, select SET TIME to set the time value, START to begin the countdown timer, PAUSE/RESUME to temporarily halt or continue, and STOP to end.</p> <p>To set the timer value, select SET TIME, press ENTER and the bar will turn red, use ◀ & ▶ to increase and decrease the value, and then press ENTER to save the setting and the bar will turn white.</p>  <p>Once the countdown timer starts, in the status box at the lower right corner of the screen, the timer format is displayed in hours : minutes : seconds.</p>
(16) SPLIT SCRΝ	<p>Divide the screen into two parts. One side displays the live image from the CP135 camera and the other side displays the captured images from the memory in 8-thumbnail images.</p> <p>Use the ▲, ▼, ◀, & ▶ to make a selection and ENTER to enlarge the selected image in split screen mode. To horizontally or vertically pan the enlarged image, use the ◀ & ▶ or ▲ & ▼ respectively.</p> <p>To switch to different split screen type or close, press SPLIT SCRΝ button repeatedly. You may also press CAMERA/PC to exit Split Screen mode and switch to Camera mode.</p>

Touch Button Control Panel

The touch button control panel located on the top side of the CP135 provides quick access to commonly used functions.

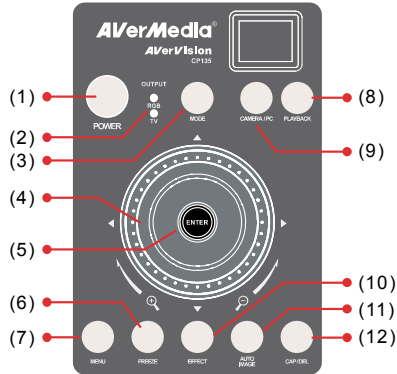

Function	Description
(1) POWER	Turn the unit on/off.
(2) Output LED Indicator	Indicate the setting of the TV to RGB switch to which port the video signal is being sent out. <ul style="list-style-type: none"> - RGB indicates that the video signal is sent out thru RGB OUTPUT port of CP135. - TV indicates that the video signal is sent out thru VIDEO and S-VIDEO OUTPUT port of CP135.
(3) MODE	Toggles between Text, Graphics, and High Frame. <ul style="list-style-type: none"> - Text - corrects the intensity of the adjacent pixel making it more uniform producing sharper and clearer images. - Graphics - adjusts the gradient of the adjacent pixel making it appears to have a smooth image. - High Frame - increases the frame rate capture and can visually tracks the motion and react quickly. Sufficient lighting is required when using this mode.
(4) Shuttle Wheel	<ul style="list-style-type: none"> - Turn the shuttle wheel clockwise to zoom in and counter-clockwise to zoom out the image in Camera and Playback mode only. When it reaches the maximum AVERZOOM level of about 200%, you can still continue to digitally zoom in the image up to 1600%. Press ENTER to return to normal view (100%). - Press the shuttle wheel ▲, ▼, ◀, & ▶ to pan the image while in zoom in mode, to make a selection on 16-thumbnail images or move to the next or previous single full screen preview in Playback mode, or to make a selection and adjustment on the OSD main-menu and sub-menu (See Menu Functions for more details).

Function	Description
(5) ENTER	Make a selection in Playback mode and OSD menu. Use this to quick zoom to 200% or back to 100% in Camera mode only.
(6) FREEZE	Toggle to pause or resume the camera.
(7) MENU	Pull up and exit the OSD main-menu and sub-menu.
(8) PLAYBACK	<p>View the captured image from the memory in 16-thumbnail images.</p> <p>Use ▲, ▼, ◀, & ▶ to make a selection and ENTER to view the selected image in full screen. To zoom in and out the image, turn the shuttle wheel clockwise and counter-clockwise.</p> <p>To start slide show, press MENU, select START and press ENTER to begin and end. Select INTERVAL to set the display time interval between frames in second.</p> <p>To change the slide show time interval, select INTERVAL, press ENTER and the bar will turn red, use ◀ & ▶ to increase and decrease the value, and then press ENTER to save the setting and the bar will turn white.</p> 
(9) CAMERA/PC	<p>Switch between Camera and PC mode.</p> <ul style="list-style-type: none"> - Camera mode displays the video signal from the built-in camera. - PC mode displays the video signal from the RGB INPUT port of CP135.
(10) EFFECT	Convert and display the image in BW, Negative or Color in Camera and Playback mode only.
(11) AUTO IMAGE	Automatically adjust and set the white balance and exposure setting.
(12) CAP/DEL	<ul style="list-style-type: none"> - Capture a still image in Camera mode. The captured image is saved in the memory and can store up to 80 images. The image size can be saved either in 1024 x 768 (default) or 2016 x 1520 pixels. <p>If the Capture setting is in Continuous mode, use CAP/DEL button to start and stop successive still image capture. To stop continuous capture, press CAP/DEL button when "SAVE" message in the status box at the lower right corner of the screen disappear.</p> <p>To set the image size of your choice, press MENU, select CAPTURE in IMAGE menu list, press ENTER, select IMG SIZE, press ENTER, use ▲ and ▼ to make a selection, and press ENTER to save the setting.</p> <ul style="list-style-type: none"> - Remove the selected picture from the built-in memory permanently in Playback mode.

OSD Navigation Tree

There are 2 tab menus in CP135: IMAGE and SETTING tabs. For TV output, the RESOLUTION will be disabled in SETTING menu list.

IMAGE MENU

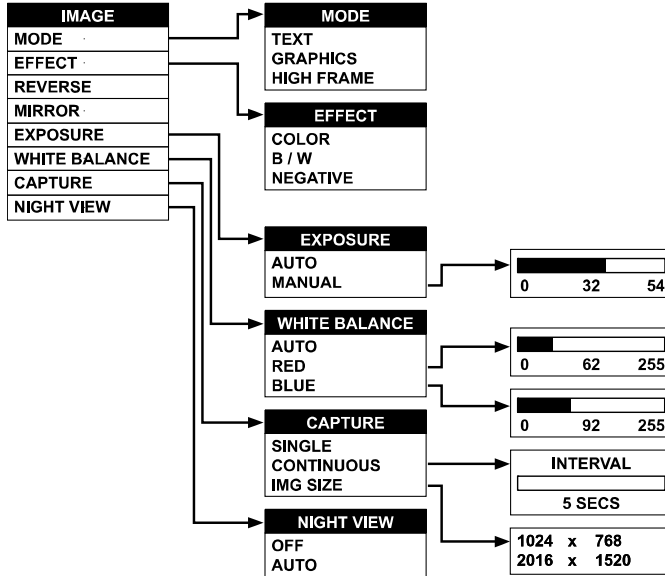

SETTING MENU

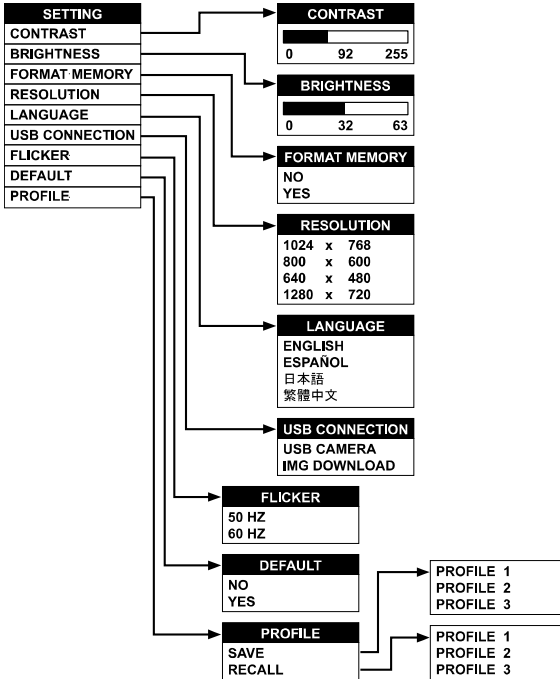

Menu Functions

The MENU functions of CP135 enhance fine-tuning your screen display, set the timer, select OSD language and more. Press the **MENU** button to call up and exit from the main menu or sub-menu display. Use **◀or▶** to select between IMAGE and SETTING menu list. Then use **▲or▼** to select the items in the menu list. To make a selection or change setting, press **ENTER**. To adjust the setting, press **◀or▶**.

OSD Menu	Description
<div style="border: 1px solid black; padding: 2px;"> <div style="background-color: black; color: white; padding: 2px;">MODE</div> <div style="background-color: orange; color: white; padding: 2px;">TEXT</div> <div style="background-color: gray; color: white; padding: 2px;">GRAPHICS</div> <div style="background-color: gray; color: white; padding: 2px;">HIGH FRAME</div> </div>	<p>IMAGE > MODE</p> <p>Use ▲ or ▼ to select between Text, Graphics and High Frame enhancement mode and then ENTER to make a selection.</p> <p>Text - corrects the intensity of the adjacent pixel making it more uniform producing sharper and clearer images.</p> <p>Graphics - adjusts the gradient of the adjacent pixel making it appears to have a smooth image.</p> <p>High Frame - increases the frame rate capture and can visually tracks the motion and react quickly. Sufficient lighting is required when using this mode.</p>

OSD Menu **Description**



IMAGE > EFFECT

Use ▲ or ▼ to select and display the image in Camera mode into positive (true color), monochrome (black and white) or negative. Then press **ENTER** to make a selection.

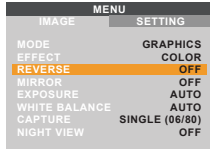

IMAGE > REVERSE

Press **ENTER** to turn off/on REVERSE. Reverse rotates the image by 180° in Camera mode.

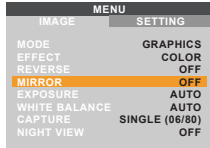

IMAGE > MIRROR

Press **ENTER** to turn off/on MIRROR. Mirror flips the image in Camera mode.



IMAGE > EXPOSURE

Use ▲ or ▼ to select between AUTO or MANUAL. Then press **ENTER** to make a selection.

AUTO to automatically adjust the camera exposure to determine how much light is required.

MANUAL to manually adjust the exposure level. Press **ENTER** and the bar will turn red, use ◀ & ▶ to increase and decrease the exposure level, and then press **ENTER** to save the setting and the bar will turn white. Press **MENU** to close the menu.



IMAGE > WHITE BALANCE

Use ▲ or ▼ to select between auto or manually adjust the red and blue color to suit the lighting condition or color temperature. Then press **ENTER** to make a selection.









To manually adjust the red or blue color level, select **RED** or **BLUE**, press **ENTER** and the bar will turn red, use ◀ & ▶ to increase and decrease the level, and then press **ENTER** to save the setting and the bar will turn white.

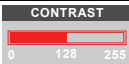

IMAGE > CAPTURE

Use ▲ or ▼ to select **SINGLE** or **CONTINUOUS** capture mode and **IMG SIZE** to select the capture pixel size of the image.

Select **SINGLE** to save one still image only and

OSD Menu	Description
	<p>CONTINUOUS to save successive still images until the built-in memory is full or when the CAP/DEL button is being press again to stop.</p> <p>In Continuous mode, press ENTER the bar will turn red, use ◀ & ▶ to increase and decrease the capture time interval between frames and then press ENTER to save the setting and the bar will turn white. The time interval can be set from 5 to 600 sec.</p>  <p>In IMG SIZE, press ENTER, use ▲ and ▼ to make a selection, and press ENTER to save the setting.</p> 
	<p>IMAGE > NIGHT VIEW</p> <p>Use ▲ or ▼ to turn Night View OFF or AUTO.</p> <p>If you are presenting in a low-light condition, Night View enables the image of the object to appear as though under normal lighting conditions. CP135 can automatically adjust the exposure to compensate for the adverse condition, but the captured image will appear to be in slow motion.</p>
	<p>SETTING > CONTRAST</p> <p>Use ▶ or ◀ to emphasize or reduce the difference between light and dark conditions then press ENTER. The contrast level can be adjustable up to 255.</p>
	<p>SETTING > BRIGHTNESS</p> <p>Use ▶ or ◀ to increase or decrease the brightness level and improve the visibility of the image then press ENTER. The brightness level can be set up to 63.</p>
	<p>SETTING > FORMAT MEMORY</p> <p>Use ▲ or ▼ to select NO to exit or YES to format and delete all the images saved in the built-in memory then press ENTER.</p> <p>Please wait till the message “FORMAT” at the lower right corner of the screen disappear to finish the process.</p>
	<p>SETTING > RESOLUTION</p> <p>Use ▲ or ▼ to choose from different supported display resolutions then press ENTER to make the selection. This selection will be disabled in TV output mode.</p>
	<p>SETTING > LANGUAGE</p> <p>Use ▲ or ▼ to select from different supported languages then press ENTER to make the selection.</p>

OSD Menu	Description																						
USB CONNECTION USB CAMERA IMG DOWNLOAD	SETTING > USB CONNECTION Use ▲or▼ buttons to select the function of USB between USB CAMERA and IMG DOWNLOAD. Then press ENTER . <ul style="list-style-type: none"> USB Camera - can be used as a computer webcam or with our bundled software to record video and capture still image. Img Download - transfer the captured images from the built-in memory to computer hard disk. 																						
FLICKER 50 HZ 60 HZ	SETTINGS > IMAGE > EXPOSURE > FLICKER Use ▲or▼ to select between 50Hz or 60Hz. Some display devices cannot handle high refresh rates. The image will flicker a couple of times as the output is switched to another refresh rate.																						
DEFAULT NO YES	DEFAULT Use ▲or▼ to select YES to restore to original factory default setting or NO to exit then press ENTER to make the selection.																						
<table border="1"> <thead> <tr> <th colspan="2">MENU</th> </tr> <tr> <th>IMAGE</th> <th>SETTING</th> </tr> </thead> <tbody> <tr><td>CONTRAST</td><td>32</td></tr> <tr><td>BRIGHTNESS</td><td>32</td></tr> <tr><td>FORMAT MEMORY</td><td>NO</td></tr> <tr><td>RESOLUTION</td><td>1024 X 768</td></tr> <tr><td>LANGUAGE</td><td>ENGLISH</td></tr> <tr><td>USB CONNECTION</td><td>USB CAMERA</td></tr> <tr><td>FLICKER</td><td>60 HZ</td></tr> <tr><td>DEFAULT</td><td>NO</td></tr> <tr><td>PROFILE</td><td>OFF</td></tr> </tbody> </table>	MENU		IMAGE	SETTING	CONTRAST	32	BRIGHTNESS	32	FORMAT MEMORY	NO	RESOLUTION	1024 X 768	LANGUAGE	ENGLISH	USB CONNECTION	USB CAMERA	FLICKER	60 HZ	DEFAULT	NO	PROFILE	OFF	SETTING > PROFILE Press ENTER and use ▲or▼ to select between SAVE or RECALL . Then press ENTER again to make a selection. <p>SAVE - store the current setting in the selected profile number. Only effect, mode, brightness and contrast settings can be saved.</p> <p>RECALL - restore the setting back to the selected profile number.</p> <p>In the SAVE/RECALL selection, use ▲or▼ to select saving/restoring the setting from the three profile number then press ENTER.</p>
MENU																							
IMAGE	SETTING																						
CONTRAST	32																						
BRIGHTNESS	32																						
FORMAT MEMORY	NO																						
RESOLUTION	1024 X 768																						
LANGUAGE	ENGLISH																						
USB CONNECTION	USB CAMERA																						
FLICKER	60 HZ																						
DEFAULT	NO																						
PROFILE	OFF																						
<table border="1"> <thead> <tr> <th colspan="2">PROFILE</th> </tr> </thead> <tbody> <tr><td>SAVE</td><td>PROFILE 1</td></tr> <tr><td>RECALL</td><td>PROFILE 2</td></tr> <tr><td></td><td>PROFILE 3</td></tr> </tbody> </table>	PROFILE		SAVE	PROFILE 1	RECALL	PROFILE 2		PROFILE 3	<table border="1"> <thead> <tr> <th colspan="2">PROFILE</th> </tr> </thead> <tbody> <tr><td>RECALL</td><td>PROFILE 1</td></tr> <tr><td></td><td>PROFILE 2</td></tr> <tr><td></td><td>PROFILE 3</td></tr> </tbody> </table>	PROFILE		RECALL	PROFILE 1		PROFILE 2		PROFILE 3						
PROFILE																							
SAVE	PROFILE 1																						
RECALL	PROFILE 2																						
	PROFILE 3																						
PROFILE																							
RECALL	PROFILE 1																						
	PROFILE 2																						
	PROFILE 3																						

Transferring the Captured Image to PC

This enables you to transfer the captured image from the built-in memory to PC.



The instruction below **MUST** be read and followed **BEFORE** connecting the USB cable.

1. **MUST** set the USB CONNECTION as IMG DOWNLOAD before connecting the USB cable.

To set the USB CONNECTION as IMG DOWNLOAD, press **MENU** > select **USB CONNECTION** in SETTING menu list and press **ENTER**, select **IMG DOWNLOAD** and press **ENTER**.

2. When “IMG DOWNLOAD” appears at the lower right corner of the presentation screen, you may now connect the USB cable.
3. Upon connecting the USB cable, the system automatically detects the new removable disk. You may now transfer the captured image(s) from the CP135 built-in memory to PC hard disk.

Troubleshooting

This section provides many useful tips on how to solve common problems while using the CP135.

There is no picture on the presentation screen.

1. Check all the connectors again as shown in this manual.
2. Check the on/off switch of the display output device.
3. Verify the setting of the display output device.
4. If you are presenting from a notebook or computer through the display output device, check the cable connection from computer RGB (VGA) output to RGB input of CP135 and make sure CP135 is in PC Mode.

I have set up the CP135 and checked all the connections as specified in the manual but I cannot get a picture on the preferred presentation screen.

1. The unit POWER button turns orange in standby mode. Press the POWER button again to turn on and the LED light will turn blue.
2. The default camera display resolution setting is on 1024x768. If your output device does not support this resolution; no image can be projected. Simply press hold the MENU and ► button to the change the resolution setting.
3. If your display output device is on TV or any analog device, please switch the TV-RGB dip switch to TV.

The picture on the presentation screen is distorted or the image is blurry.

1. Reset all changed settings, if any, to the original manufacturer default setting (Refer to the Menu Functions for more details and steps).
2. Use the Brightness and Contrast menu functions to reduce the distortion if applicable.
3. If you discover that the image is blurry or out of focus, adjust the focus ring on the camera head.

There is no computer signal on presentation screen.

1. Check all the cable connections among the display device, CP155 and your PC.
2. Connect your PC to the CP155 first before you power on your computer.
3. For notebook, repeatedly press FN+F5 to toggles between display modes and display the computer image on the presentation screen. For different command, please refer to your laptop manual.

The presentation screen does not show the exact desktop image on my PC or Notebook after I toggle from Camera to PC mode.

1. Return to your PC or Notebook, place the mouse on the desktop and right click, choose "Properties", choose "Setting" tab, click on "2" monitor and check the box "Extend my Windows desktop onto this monitor".
2. Then go back one more time to your PC or Notebook and place the mouse on the desktop and right click again.
3. This time choose "Graphics Options", then "Output To", then "Intel® Dual Display Clone", and then choose "Monitor + Notebook".
4. After you follow these steps, you should be able to see the same desktop image on your PC or Notebook as well as on the presentation screen.

How do I transfer the images from CP135 to a computer? Is it normal that CP135 will reset to camera mode after I download images and disconnect the USB cable?

Choose "IMG DOWNLOAD" in SETTING tab, USB CONNECTION menu, and then connect the USB cable to transfer the captured images from the CP135 to the computer. When finished, unplug the USB cable. The CP135 will automatically reset and switch to camera mode.

Limited Warranty

For a period of time beginning on the date of purchase of the applicable product and extending as set forth in the "**Warranty Period of AVerMedia Product Purchased**" section of the warranty card, AVerMedia Information, Inc. ("AVerMedia") warrants that the applicable product ("Product") substantially conforms to AVerMedia's documentation for the product and that its manufacture and components are free of defects in material and workmanship under normal use. "You" as used in this agreement means you individually or the business entity on whose behalf you use or install the product, as applicable. This limited warranty extends only to You as the original purchaser. Except for the foregoing, the Product is provided "AS IS." In no event does AVerMedia warrant that You will be able to operate the Product without problems or interruptions, or that the Product is suitable for your purposes. Your exclusive remedy and the entire liability of AVerMedia under this paragraph shall be, at AVerMedia's option, the repair or replacement of the Product with the same or a comparable product. This warranty does not apply to (a) any Product on which the serial number has been defaced, modified, or removed, or (b) cartons, cases, batteries, cabinets, tapes, or accessories used with this product. This warranty does not apply to any Product that has suffered damage, deterioration or malfunction due to (a) accident, abuse, misuse, neglect, fire, water, lightning, or other acts of nature, commercial or industrial use, unauthorized product modification or failure to follow instructions included with the Product, (b) misapplication of service by someone other than the manufacturer's representative, (c) any shipment damages (such claims must be made with the carrier), or (d) any other causes that do not relate to a Product defect. The Warranty Period of any repaired or replaced Product shall be the longer of (a) the original Warranty Period or (b) thirty (30) days from the date of

delivery of the repaired or replaced product.

Limitations of Warranty

AVerMedia makes no warranties to any third party. You are responsible for all claims, damages, settlements, expenses, and attorneys' fees with respect to claims made against You as a result of Your use or misuse of the Product. This warranty applies only if the Product is installed, operated, maintained, and used in accordance with AVerMedia specifications. Specifically, the warranties do not extend to any failure caused by (i) accident, unusual physical, electrical, or electromagnetic stress, neglect or misuse, (ii) fluctuations in electrical power beyond AVerMedia specifications, (iii) use of the Product with any accessories or options not furnished by AVerMedia or its authorized agents, or (iv) installation, alteration, or repair of the Product by anyone other than AVerMedia or its authorized agents.

Disclaimer of Warranty

EXCEPT AS EXPRESSLY PROVIDED OTHERWISE HEREIN AND TO THE MAXIMUM EXTENT PERMITTED BY APPLICABLE LAW, AVERMEDIA DISCLAIMS ALL OTHER WARRANTIES WITH RESPECT TO THE PRODUCT, WHETHER EXPRESS, IMPLIED, STATUTORY OR OTHERWISE, INCLUDING WITHOUT LIMITATION, SATISFACTORY QUALITY, COURSE OF DEALING, TRADE USAGE OR PRACTICE OR THE IMPLIED WARRANTIES OF MERCHANTABILITY, FITNESS FOR A PARTICULAR PURPOSE OR NONINFRINGEMENT OF THIRD PARTY RIGHTS.

Limitation of Liability

IN NO EVENT SHALL AVERMEDIA BE LIABLE FOR INDIRECT, INCIDENTAL, SPECIAL, EXEMPLARY, PUNITIVE, OR CONSEQUENTIAL DAMAGES OF ANY NATURE INCLUDING, BUT NOT LIMITED TO, LOSS OF PROFITS, DATA, REVENUE, PRODUCTION, OR USE, BUSINESS INTERRUPTION, OR PROCUREMENT OF SUBSTITUTE GOODS OR SERVICES ARISING OUT OF OR IN CONNECTION WITH THIS LIMITED WARRANTY, OR THE USE OR PERFORMANCE OF ANY PRODUCT, WHETHER BASED ON CONTRACT OR TORT, INCLUDING NEGLIGENCE, OR ANY OTHER LEGAL THEORY, EVEN IF AVERMEDIA HAS ADVISED OF THE POSSIBILITY OF SUCH DAMAGES. AVERMEDIA'S TOTAL, AGGREGATE LIABILITY FOR DAMAGES OF ANY NATURE, REGARDLESS OF FORM OF ACTION, SHALL IN NO EVENT EXCEED THE AMOUNT PAID BY YOU TO AVERMEDIA FOR THE SPECIFIC PRODUCT UPON WHICH LIABILITY IS BASED.

Governing Law and Your Rights

This warranty gives You specific legal rights; You may also have other rights granted under state law. These rights vary from state to state.



For warranty period, please refer to the warranty card.
