

## Federal Communications Commission Statement(Class A)



NOTE- This equipment has been tested and found to comply with the limits for a Class A digital device, pursuant to Part 15 of the FCC Rules. These limits are designed to provide reasonable protection against harmful interference in a residential installation. This equipment generates uses and can radiate radio frequency energy and, if not installed and used in accordance with the instructions, may cause harmful interference to radio communications. However, there is no guarantee that interference will not occur in a particular installation. If this equipment does cause harmful interference to radio or television reception, which can be determined by tuning the equipment off and on, the user is encouraged to try to correct the interference by one or more of the following measures:

- Reorient or relocate the receiving antenna.
- Increase the separation between the equipment and receiver.
- Connect the equipment into an outlet on a circuit different from that to which the receiver is connected.
- Consult the dealer or an experienced radio/television technician for help.

### Class A ITE:

Class A ITE is a category of all other ITE which satisfies the class A ITE limits but not the class B ITE limits. Such equipment should not be restricted in its sale but the following warning shall be included in the instructions for use:

**Warning** - This is a class A product. In a domestic environment this product may cause radio interference in which case the user may be required to take adequate measures.

### CE Class A (EMC)



This product is herewith confirmed to comply with the requirements set out in the Council Directives on the Approximation of the laws of the Member States relating to Electromagnetic Compatibility Directive 2004/108/EEC.

**Warning** - This is a Class A product. In a domestic environment this product may cause radio interference in which case the user may be required to take adequate measures to correct this interference.

### DISCLAIMER

No warranty or representation, either expressed or implied, is made with respect to the contents of this documentation, its quality, performance, merchantability, or fitness for a particular purpose. Information presented in this documentation has been carefully checked for reliability; however, no responsibility is assumed for inaccuracies. The information contained in this documentation is subject to change without notice.

In no event will AVerMedia be liable for direct, indirect, special, incidental, or consequential damages arising out of the use or inability to use this product or documentation, even if advised of the possibility of such damages.



205 Westwood Ave, Long Branch, NJ 07740

Phone: 866-94 BOARDS (26273) / (732)-222-1511

Fax: (732)-222-7088 | E-mail: sales@touchboards.com

## TRADEMARKS

AVerVision is registered trademarks of AVerMedia Information, Inc. IBM PC is a registered trademark of International Business Machines Corporation. Macintosh is a registered trademark of Apple Computer, Inc. Microsoft is a registered trademark and Windows is a trademark of Microsoft Corporation. All other products or corporate names mentioned in this documentation are for identification and explanation purposes only, and may be trademarks or registered trademarks of their respective owners.

## COPYRIGHT

© 2009 by AVerMedia Information, Inc. All rights reserved. No part of this publication may be reproduced, transmitted, transcribed, stored in a retrieval system, or translated into any language in any form by any means without the written permission of AVerMedia INFORMATION, Inc.



THE MARK OF CROSSED-OUT WHEELED BIN INDICATES THAT THIS PRODUCT MUST NOT BE DISPOSED OF WITH YOUR OTHER HOUSEHOLD WASTE. INSTEAD, YOU NEED TO DISPOSE OF THE WASTE EQUIPMENT BY HANDING IT OVER TO A DESIGNATED COLLECTION POINT FOR THE RECYCLING OF WASTE ELECTRICAL AND ELECTRONIC EQUIPMENT. FOR MORE INFORMATION ABOUT WHERE TO DROP OFF YOUR WASTE EQUIPMENT FOR RECYCLING, PLEASE CONTACT YOUR HOUSEHOLD WASTE DISPOSAL SERVICE OR THE SHOP WHERE YOU PURCHASED THE PRODUCT.

## Remote Control Battery Safety Information

- Store batteries in any cool & dry place.
- Do not dispose used batteries in domestic waste. Dispose batteries at special collection points or return to stores if applies.
- Remove the batteries if they are not in use for long period of time. Battery leakage and corrosion can damage the remote control, dispose batteries safely.
- Do not mix and use old and new batteries.
- Do not mix and use different types of batteries: alkaline, standard (carbon-zinc) or rechargeable (nickel-cadmium).
- Do not dispose batteries in a fire.
- Do not attempt to short circuit the battery terminals.

## Class 2 Laser Product



LASER RADIATION  
DO NOT STARE INTO THE BEAM  
CLASS 2 LASER PRODUCT

# Table of Contents

<b>Introduction .....</b>	<b>1</b>
<b>Package Contents .....</b>	<b>1</b>
<b>Optional Accessories.....</b>	<b>2</b>
<b>AVerVision CP355 Parts.....</b>	<b>3</b>
<b>Technical Specifications.....</b>	<b>4</b>
<b>Making the Connections.....</b>	<b>5</b>
Connecting the Power Adapter .....	6
Connecting a TV .....	6
Connecting a CRT/LCD/MAC Display Monitor or LCD/DLP Projector .....	7
Connecting an LCD/MAC Display Monitor or LCD/DLP Projector with DVI-I interface .....	7
Connecting a Computer .....	8
Connecting a Computer via USB .....	8
Connecting to a Microscope .....	9
<b>Setting Up AVerVision CP355.....</b>	<b>9</b>
Camera Head .....	9
LED Light Switch.....	9
Infrared Sensor .....	10
Flexible Gooseneck and Arm .....	10
Anti-glare Sheet .....	10
<b>Using the Infrared Remote Control .....</b>	<b>11</b>
<b>Touch Button Control Panel.....</b>	<b>15</b>
<b>OSD Navigation Tree.....</b>	<b>17</b>
<b>Menu Functions.....</b>	<b>18</b>
<b>RS-232C Diagram Connection .....</b>	<b>22</b>
<b>RS-232C Cable Spec .....</b>	<b>22</b>
<b>RS-232C Transmission Spec.....</b>	<b>22</b>
<b>RS-232C Communication Format.....</b>	<b>22</b>
<b>RS-232C Command Table.....</b>	<b>23</b>
<b>Transferring the Captured Image to PC.....</b>	<b>23</b>
<b>Troubleshooting .....</b>	<b>24</b>
<b>Limited Warranty .....</b>	<b>25</b>



## Introduction

Thank you for purchasing the AVerMedia® AVerVision CP355.

AVerVision CP355 is integrated with 5X optical zoom and wide angle technology to increase the area of visibility. You can use this to display documents, negatives, transparencies, and 3D objects onto a TV, LCD or DLP projector making presentations a snap.

AVerVision CP355 is an ideal presentation tool for business, academic, medical and the scientific community.

# AVerMedia

## Package Contents

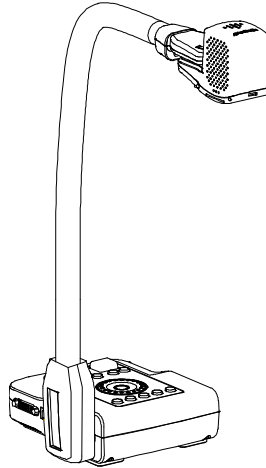

AVerMedia® AVerVision CP355

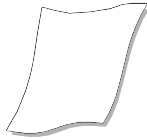

Anti-glare Sheet



Bag

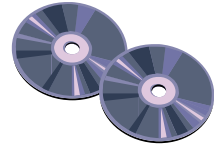

Software & Manual CD

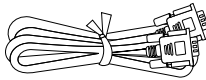

RGB Cable

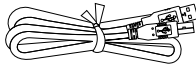

USB Cable



Remote Control  
(batteries included)

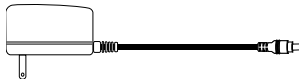

Power Adapter

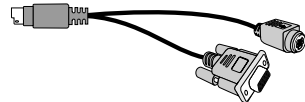

S-Video/RS-232 Cable

\* The power adapter will vary depending on the standard power outlet of the country where it is sold.

## Optional Accessories

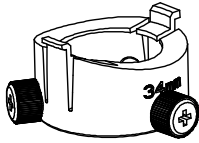

34mm Microscope Adapter

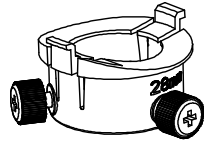

28mm Microscope Adapter

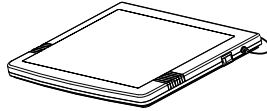

Light Box

**ALVerMedia**

## AVerVision CP355 Parts

The illustrations below identify the parts of AVerVision CP355.

- (1) Camera head
- (2) LED light
- (3) Camera lens
- (4) LED light switch
- (5) IR sensor
- (6) Control panel
- (7) Right panel
- (8) Gooseneck
- (9) Rear panel
- (10) Left panel
- (11) Label slot

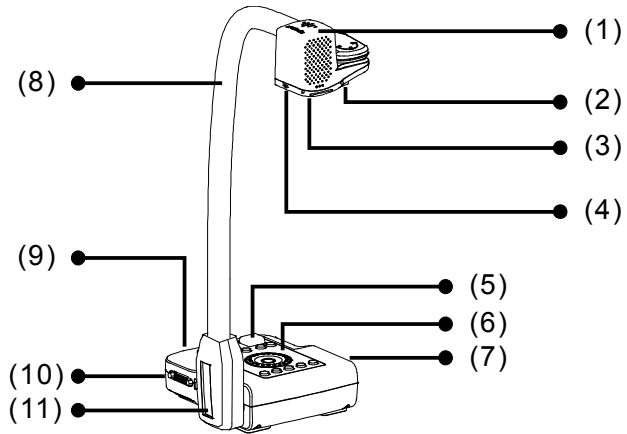

- (12) DC 12V port
- (13) Antitheft slot
- (14) Camera head holder

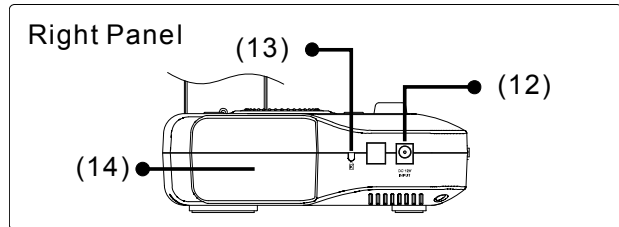

- (15) S-Video output port
- (16) Composite video output port
- (17) RGB input port
- (18) RGB output port

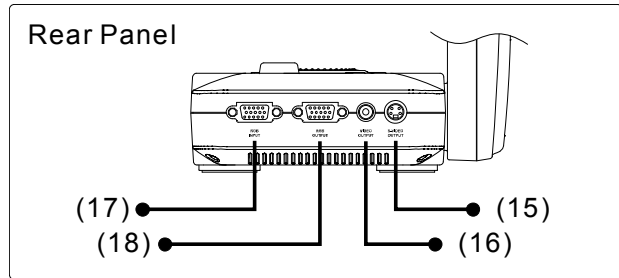

- (19) TV-RGB switch
- (20) USB port
- (21) DVI-I output port

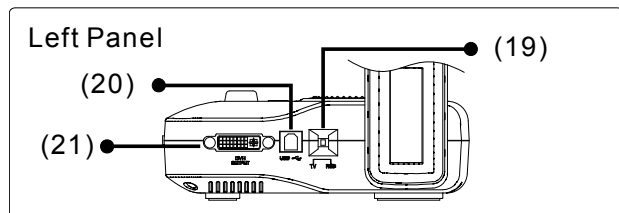

AVerMedia

## Technical Specifications

### Image

Sensor	1/2.5" Progressive Scan CMOS
Pixel Count	3.2 mega pixels
Frame Rate	24 fps (max.)
White Balance	Auto / Manual
Exposure	Auto / Manual
Image mode	Text / Graphics / High Frame / Wide Angle / Microscope / Macro / Infinite
Effect	Color / B/W / Negative / Mirror / Reverse / Freeze
Analog RGB output	HD 720P; XGA 60 Hz; SVGA 60 Hz; VGA 60 Hz
Image Capture	Up to 80 Frames

### Optics

Lens	F3.2 (Wide); F6.8 (Tele)
Focusing	Auto / Manual
Shooting Area	315mm x 236mm 400mm x 300mm (max.) (wide angle mode)
Zooming	5X Optical Zoom, 2X AVERZOOM, 8X Digital Zoom

### Power

Power Source	DC 12V, 100-240V, 50-60Hz
Consumption	18 Watts (lamp off); 20 Watts (lamp on)

### Lighting

Lamp Type	LED light with laser pointer
-----------	------------------------------

### Input/Output

RGB Input	15-Pins D-sub (VGA)
RGB Output	15-Pins D-sub (VGA)
DVI-I Output	DVI-I Type
S-Video/RS-232	Mini-DIN Jack (use S-Video/RS-232 Adapter cable)
Composite Video	RCA Jack
USB	USB2.0
DC 12V Input	Power Jack

### Dimension

Operating	430mm x 180mm x 600mm
Folded	355mm x 245mm x 63mm
Weight	2.6 kg (about 5.73 lbs)



## Making the Connections

The ports on the rear, left and right panel of CP355 enable you to connect the unit to a computer, graphics display monitor or LCD/DLP projector, TV or other device. Illustrated below are the ports that are located at the rear, left and right panel of CP355 with their corresponding labels.

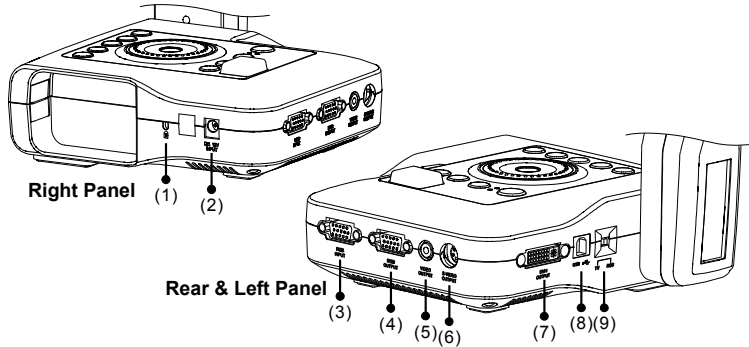

Port	Description
(1) Antitheft Slot	Attach a Kensington compatible security lock or antitheft device.
(2) DC 12V Input	Connect the power adapter into this port.
(3) RGB INPUT	Input the signal from a computer or other sources and pass it through to the RGB Output port only. Connect this port to the RGB/VGA output port of the computer.
(4) RGB OUTPUT	Output the signal from the camera, RGB input port, or the captured images from the memory on a CRT/LCD/MAC monitor or LCD/DLP projector.
(5) VIDEO OUTPUT (RCA/Composite)	Output the signal from the camera or the captured images from the memory on TV or Video equipment. Connect this port to the VIDEO input port of a TV or video equipment.
(6) S-VIDEO OUTPUT	Output the signal from the camera or the captured images from the memory on TV or Video equipment. Connect this port to the S-VIDEO input port of a TV or video equipment.
(7) DVI-I OUTPUT	Output the signal from the camera, RGB input port, or the captured images from the memory on a CRT/LCD/MAC monitor or LCD/DLP projector with DVI-I interface. If the display device does not support DVI-I, it can only display the signal from the camera and the captured images.

Port	Description
(8) USB	Use CP355 as a USB Camera or transfer the captured images from CP355 memory to PC. Connect this port to the USB port of the computer.
(9) TV-RGB switch	Switch to output display video either from Video and S-VIDEO, or RGB and DVI-I output port.

## Connecting the Power Adapter

Connect the power adapter to a standard 100V~240V AC power source.

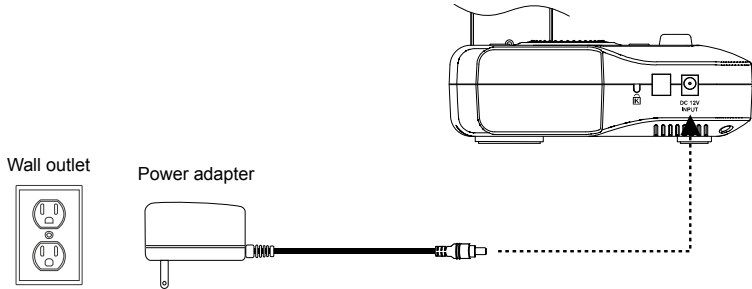

## Connecting a TV

Locate the VIDEO, S-VIDEO or SCART RGB input port of the TV or Video equipment (i.e., VCR) to record your presentation on a videotape and connect it to S-VIDEO or VIDEO OUTPUT port of CP355.



- For better video quality, we strongly suggest using S-VIDEO connection.
- Make sure the TV/RGB switch is set to TV.

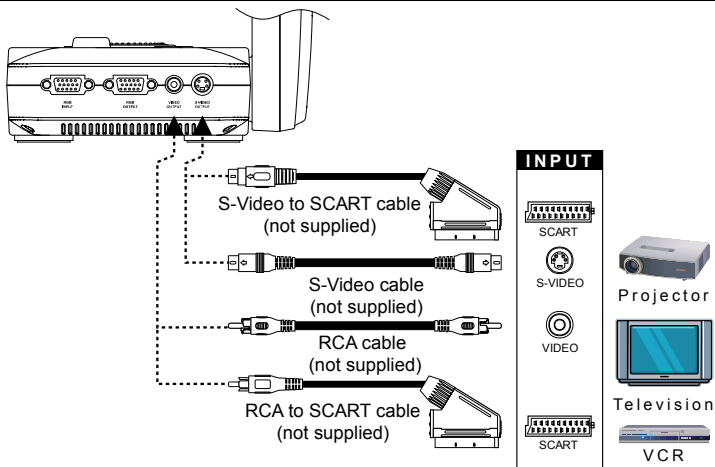

## Connecting a CRT/LCD/MAC Display Monitor or LCD/DLP Projector

Locate the RGB (VGA) input port of the graphics display device and connect it to RGB OUTPUT port of CP355.



Make sure the TV/RGB switch is set to RGB.

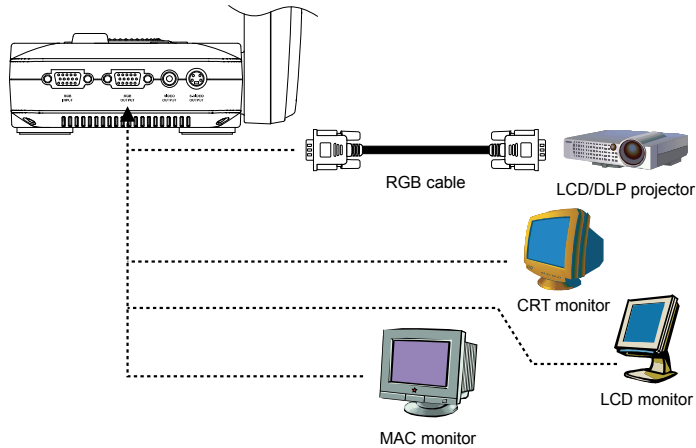

## Connecting an LCD/MAC Display Monitor or LCD/DLP Projector with DVI-I interface

Locate the DVI-I input port of the display device and connect it to DVI-I OUTPUT port of CP355.



Make sure the TV/RGB switch is set to RGB.

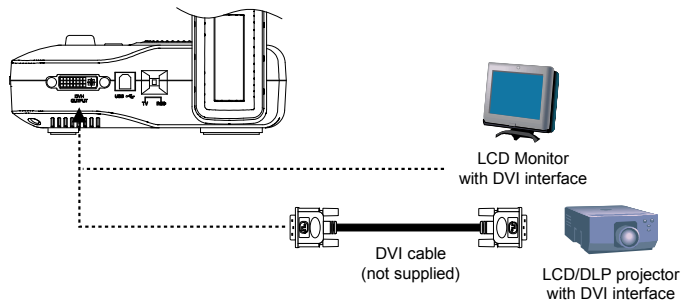

## Connecting a Computer

Locate the RGB (VGA) output port of the computer or laptop to display your PC presentation on screen and connect it to RGB INPUT port of CP355. The video signal from the RGB INPUT port is streamed to RGB OUTPUT port, and displayed on the screen.



- To display computer image, press Camera/PC button on the control panel or remote control to switch CP355 to PC mode.
- For laptop to output display image, use the keyboard command (FN+F5) to switch between the display modes. For different command, please refer to your laptop manual.

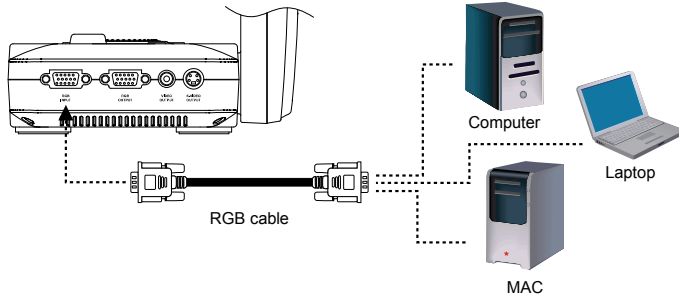

## Connecting a Computer via USB

Locate the USB port of the computer or laptop and connect it to USB port of CP355. This enables you to use CP355 as a USB Camera and to transfer the captured images from the memory and to computer. Also see “Transfer Image from AVerVision CP355 to PC”.

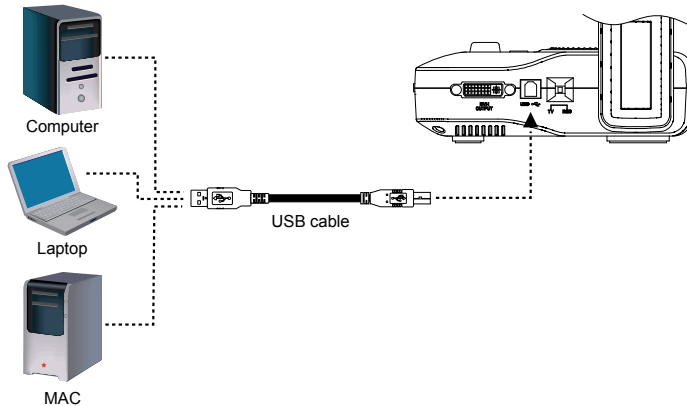

## Connecting to a Microscope

Connecting the CP355 to a microscope enables you to examine microscopic objects on a big screen without straining your eyes.



Make sure to connect the longer hook to the front latch hole of the camera head.

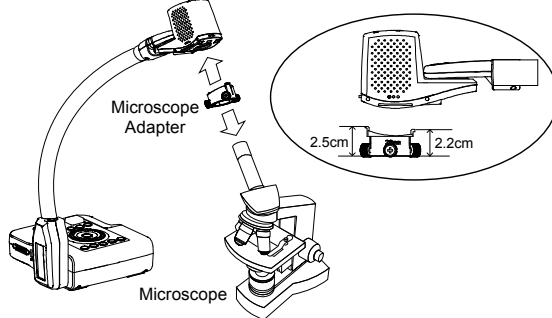

## Setting Up AVerVision CP355

This section provides useful tips on how to adjust the CP355 to meet your needs.

### Camera Head

The camera head can be turned 90° to the left and right.

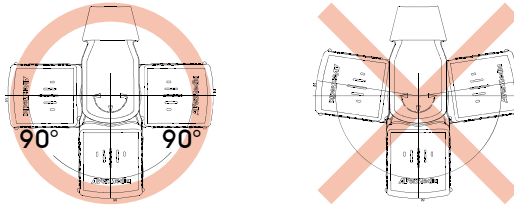

### LED Light Switch

A unique feature of the CP355 is the four (4) laser positioning pointers that define the viewing area. This enables the user to quickly center the object underneath the camera. The three (3) various light and laser positioning pointers settings are provided as follows:

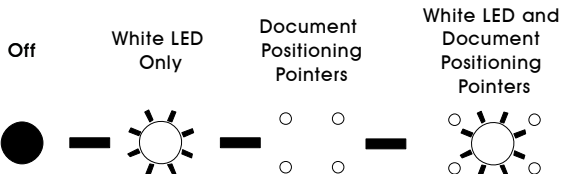
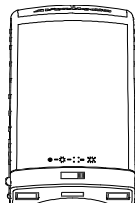

## Infrared Sensor

Aim the remote control at the infrared sensor to operate the unit.

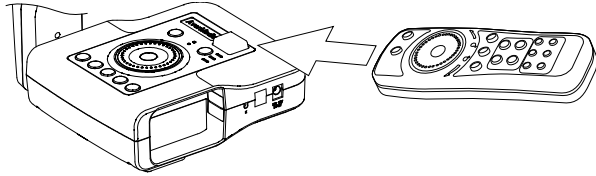

## Flexible Gooseneck and Arm

The flexible gooseneck and arm design allows you to position the camera head from any angle.



When positioning the camera head in upright position, press **REVERSE** on the remote control to rotate the image 180°. You may also rotate the image 180° in OSD menu. Just press **MENU**, select **REVERSE** in IMAGE menu list, and then press **ENTER** to turn on/off image reverse.

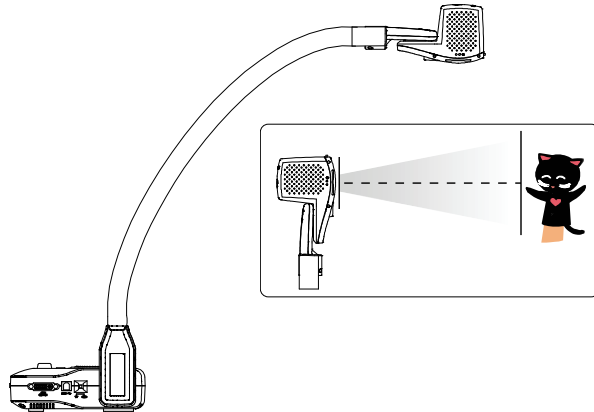

## Anti-glare Sheet

The anti-glare sheet is a special coated film that helps eliminate any glare that maybe encountered while displaying very shiny objects or glossy surfaces such as magazines and pictures. To use, simply place the anti-glare sheet on top of the shiny document to reduce reflected light.

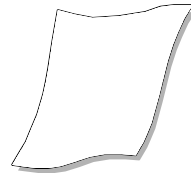

## Using the Infrared Remote Control

Use the CP355 Remote Control to enhance your presentation by having the ability to switch between three (3) presentation modes and access various features. To use the remote control, first insert the batteries (2 “AAA” size batteries are provided) into the battery compartment at the back of the remote. Use the figure and descriptions below as a reference for remote control functions.

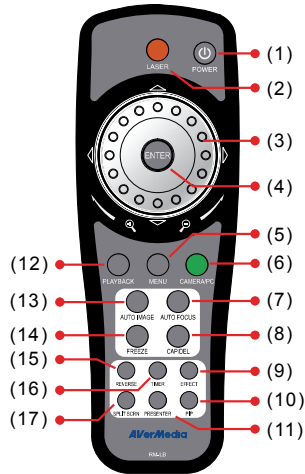

Name	Function
(1) POWER	Turn the unit on/off.
(2) LASER	Turn on the laser pointer.  <div style="display: flex; align-items: center;"> <div style="margin-right: 10px;">  </div> <div> <p><b>DO NOT</b> look directly at the laser pointer and avoid aiming the laser at any surface that may reflect the beam (i.e., a mirror or mirrored surface).</p> </div> </div>
(3) Shuttle Wheel	<ul style="list-style-type: none"> <li>- Turn the shuttle wheel clockwise to zoom in and counter-clockwise to zoom out the image in Camera and Playback mode only. When it reaches the maximum optical zoom level of about 5X, you can still continue to AVERZOOM up to 2X and 8X digitally zoom. To return to normal view (100%), press <b>ENTER</b>.</li> <li>- Press the shuttle wheel ▲, ▼, ◀, &amp; ▶ to pan the image while in zoom in mode, to make a selection on 16-thumbnail images or move to the next or previous single full screen preview in Playback mode, or to make a selection and adjustment on the OSD main-menu and sub-menu (See Menu Functions for more details).</li> </ul>

Name	Function
(4) ENTER	Make a selection in Playback mode and OSD menu. Use this to quick zoom to 200% or back to 100% in Camera mode only.
(5) MENU	Pull up and exit the OSD main-menu and sub-menu.
(6) CAMERA/PC	Switch between Camera and PC mode. <ul style="list-style-type: none"> <li>- Camera mode displays the video signal from the built-in camera.</li> <li>- PC mode displays the video signal from the RGB INPUT port of CP355.</li> </ul>
(7) AUTO FOCUS	Adjust the focus automatically.
(8) CAP/DEL	<p>- Capture a still image in Camera mode. The captured image is saved in the memory and can store up to 80 images. The image size can be saved either in 1024 x 768 (default) or 2016 x 1520 pixels.</p> <p>If the Capture setting is in Continuous mode, use <b>CAP/DEL</b> button to start and stop successive still image capture. To stop continuous capture, press <b>CAP/DEL</b> button when "SAVE" message in the status box at the lower right corner of the screen disappear.</p> <p>To set the image size of your choice, press <b>MENU</b>, select <b>CAPTURE</b> in IMAGE menu list, press <b>ENTER</b>, select <b>IMG SIZE</b>, press <b>ENTER</b>, use <b>▲</b> and <b>▼</b> to make a selection, and press <b>ENTER</b> to save the setting.</p> <ul style="list-style-type: none"> <li>- Remove the selected picture from the built-in memory permanently in Playback mode.</li> </ul>
(9) EFFECT	Convert and display the image in BW, Negative or Color in Camera and Playback mode only.
(10) PIP	<p>Show a thumbnail size playback screen at the corner of the screen to view the captured image from the memory in Camera mode.</p> <p>Use <b>◀</b> or <b>▶</b> to move to the previous or next image and <b>ENTER</b> to view the image in full screen and press <b>ENTER</b> again to go back to PIP mode.</p> <p>To move the thumbnail playback screen to different corners or close, press PIP button repeatedly. You may also press CAMERA/PC to exit PIP mode and switch to Camera mode.</p>
(11) PRESENTER	<p>Select to turn on/off AVERBOX or AVERVISOR. Only one feature can be used at a time.</p> <p>In the PRESENTER menu, use <b>▲</b> and <b>▼</b> to select between AVERBOX or AVERVISOR, and press <b>ENTER</b> to turn on/off the selected feature. Then press <b>MENU</b> to close menu or execute the turned</p>



Name	Function
------	----------

on feature. To exit AVerBox or AVerVisor mode, press CAMERA/PC to switch to Camera mode.

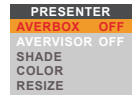

(10) PRESENTER

- AVerBox overlays a frame on the presentation screen. Selecting **SHADE** changes the opacity of the area outside the box from 0%, 50% and 100%, **COLOR** to change the frame color from red, green and blue, and **RESIZE** to change the size of the frame.
- To resize the frame, press the shuttle wheel **▲**, **▼**, **◀**, & **▶** then press **ENTER** when done resizing.
- To move the frame around the presentation screen, use the shuttle wheel **▲**, **▼**, **◀**, & **▶**.

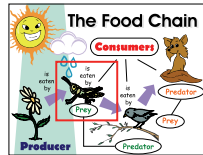

- AVerVisor covers part of the presentation screen. The upper part of the presentation screen is slightly exposed when it is being called each time. To expose part of the covered area, press the shuttle wheel **▲**, **▼**, **◀**, & **▶**. Select **SHADE** to change the darkness of the shaded area between 50% or 100%.





(12) PLAYBACK

View the captured image from the memory in 16-thumbnail images.

Use **▲**, **▼**, **◀**, & **▶** to make a selection and **ENTER** to view the selected image in full screen. To zoom in and out the image, turn the shuttle wheel clockwise and counter-clockwise.

To start slide show, press **MENU**, select **START** and press **ENTER** to begin and end. Select **INTERVAL** to set the display time interval between frames in second.

To change the slide show time interval, select **INTERVAL**, press **ENTER** and the bar will turn red, use **◀** & **▶** to increase and decrease the value, and

Name	Function
	<p>then press <b>ENTER</b> to save the setting and the bar will turn white.</p> 
(13) AUTO IMAGE	Automatically adjust and set the white balance and exposure setting.
(14) FREEZE	Toggle to pause or resume the camera.
(15) REVERSE	Rotate the image by 180° in Camera mode only.
(16) TIMER	<p>Set/start/pause/resume the timer in TIMER menu. The timer will automatically count up after count down reaches zero to show the elapsed time. The timer continues to run even when you switch to different modes.</p> <p>In TIMER menu, select <b>SET TIME</b> to set the time value, <b>START</b> to begin the countdown timer, <b>PAUSE/RESUME</b> to temporarily halt or continue, and <b>STOP</b> to end.</p> <p>To set the timer value, select <b>SET TIME</b>, press <b>ENTER</b> and the bar will turn red, use <b>◀ &amp; ▶</b> to increase and decrease the value, and then press <b>ENTER</b> to save the setting and the bar will turn white.</p>  <p>Once the countdown timer starts, in the status box at the lower right corner of the screen, the timer format is displayed in hours : minutes : seconds.</p>
(17) SPLIT SCRN	<p>Divide the screen into two parts. One side displays the live image from the CP355 camera and the other side displays the captured images from the memory in 8-thumbnail images.</p> <p>Use the <b>▲, ▼, ◀, &amp; ▶</b> to make a selection and <b>ENTER</b> to enlarge the selected image in split screen mode. To horizontally or vertically pan the enlarged image, use the <b>◀ &amp; ▶</b> or <b>▲ &amp; ▼</b> respectively.</p> <p>To switch to different split screen type or close, press <b>SPLIT SCRN</b> button repeatedly. You may also press <b>CAMERA/PC</b> to exit Split Screen mode and switch to Camera mode.</p>

## Touch Button Control Panel

The touch button control panel located on the top side of the CP355 provides quick access to commonly used functions.

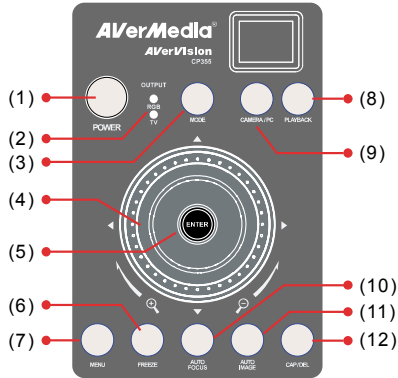

Function	Description
(1) POWER	Turn the unit on/off.
(2) Output LED Indicator	Indicate the setting of the TV to RGB switch to which port the video signal is being sent out. <ul style="list-style-type: none"> <li>- RGB indicates that the video signal is sent out thru RGB OUTPUT port of CP355.</li> <li>- TV indicates that the video signal is sent out thru VIDEO and S-VIDEO OUTPUT port of CP355.</li> </ul>
(3) MODE	Toggles between Text, Graphics, and High Frame. <b>Text</b> - corrects the intensity of the adjacent pixel making it more uniform producing sharper and clearer images. <b>Graphics</b> - adjusts the gradient of the adjacent pixel making it appears to have a smooth image. <b>High Frame</b> - increases the frame rate capture and can visually tracks the motion and react quickly. Sufficient lighting is required when using this mode. <b>Wide Angle</b> - extends the area of visibility up to 400mm x 300mm shooting area.
(4) Shuttle Wheel	<ul style="list-style-type: none"> <li>- Turn the shuttle wheel clockwise to zoom in and counter-clockwise to zoom out the image in Camera and Playback mode only. When it reaches the maximum optical zoom level of about 5X, you can still continue to AVERZOOM up to 2X and 8X digitally zoom. To return to normal view (100%), press <b>ENTER</b>.</li> <li>- Press the shuttle wheel <b>▲</b>, <b>▼</b>, <b>◀</b>, &amp; <b>▶</b> to pan the image while in zoom in mode, to make a selection on 16-thumbnail images or move to the next or previous single full screen preview in Playback</li> </ul>

Function	Description
Shuttle Wheel	mode, or to make a selection and adjustment on the OSD main-menu and sub-menu (See Menu Functions for more details).
(5) ENTER	Make a selection in Playback mode and OSD menu. Use this to quick zoom to 200% or back to 100% in Camera mode only.
(6) FREEZE	Toggle to pause or resume the camera.
(7) MENU	Pull up and exit the OSD main-menu and sub-menu.
(8) PLAYBACK	<p>View the captured image from the memory in 16-thumbnail images.</p> <p>Use ▲, ▼, ◀, &amp; ▶ to make a selection and <b>ENTER</b> to view the selected image in full screen. To zoom in and out the image, turn the shuttle wheel clockwise and counter-clockwise.</p> <p>To start slide show, press <b>MENU</b>, select <b>START</b> and press <b>ENTER</b> to begin and end. Select <b>INTERVAL</b> to set the display time interval between frames in second.</p> <p>To change the slide show time interval, select <b>INTERVAL</b>, press <b>ENTER</b> and the bar will turn red, use ◀ &amp; ▶ to increase and decrease the value, and then press <b>ENTER</b> to save the setting and the bar will turn white.</p> 
(9) CAMERA/PC	<p>Switch between Camera and PC mode.</p> <ul style="list-style-type: none"> <li>- Camera mode displays the video signal from the built-in camera.</li> <li>- PC mode displays the video signal from the RGB INPUT port of CP355.</li> </ul>
(10) AUTO FOCUS	Adjust the focus automatically.
(11) AUTO IMAGE	Automatically adjust and set the white balance and exposure setting.
(12) CAP/DEL	<p>- Capture a still image in Camera mode. The captured image is saved in the memory and can store up to 80 images. The image size can be saved either in 1024 x 768 (default) or 2016 x 1520 pixels.</p> <p>If the Capture setting is in Continuous mode, use <b>CAP/DEL</b> button to start and stop successive still image capture. To stop continuous capture, press <b>CAP/DEL</b> button when "SAVE" message in the status box at the lower right corner of the screen disappear.</p> <p>To set the image size of your choice, press <b>MENU</b>, select <b>CAPTURE</b> in IMAGE menu list, press <b>ENTER</b>, select <b>IMG SIZE</b>, press <b>ENTER</b>, use ▲ and</p>

Function	Description
(CAP/DEL)	<ul style="list-style-type: none"> <li>▼ to make a selection, and press <b>ENTER</b> to save the setting.</li> <li>- Remove the selected picture from the built-in memory permanently in Playback mode.</li> </ul>

## OSD Navigation Tree

There are 2 tab menus in CP355: IMAGE and SETTING tabs. For TV output, the RESOLUTION will be disabled in SETTING menu list.

### IMAGE MENU

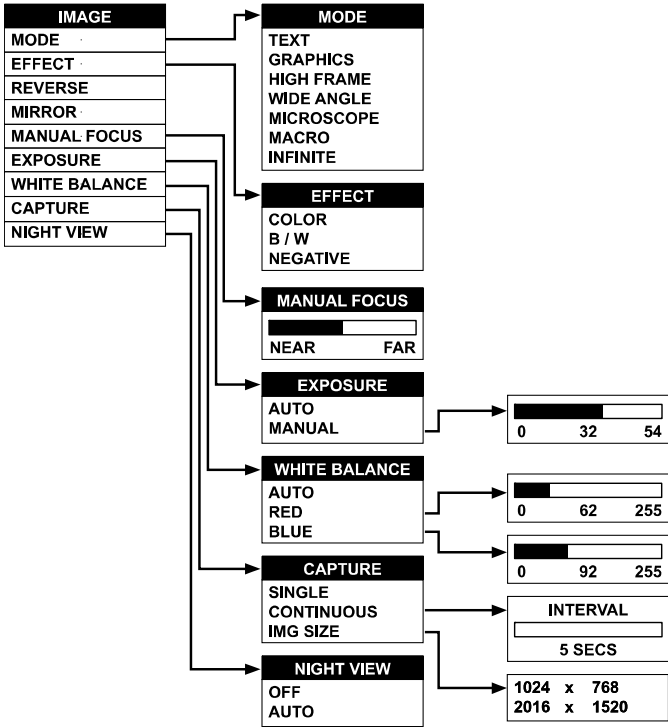



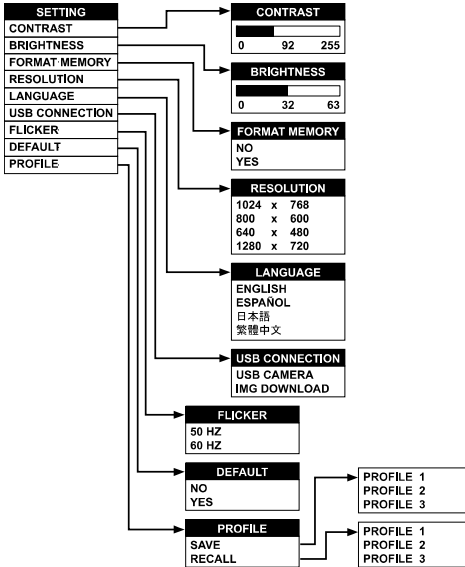



## SETTING MENU



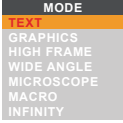

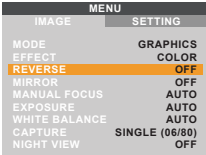
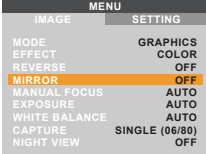



## Menu Functions

The MENU functions of CP355 enhance fine-tuning your screen display, set the timer, select OSD language and more. Press the **MENU** button to call up and exit from the main menu or sub-menu display. Use ◀ or ▶ to select between IMAGE and SETTING menu list. Then use ▲ or ▼ to select the items in the menu list. To make a selection or change setting, press **ENTER**. To adjust the setting, press ◀ or ▶.

OSD Menu	Description
<b>MODE</b> <b>TEXT</b> GRAPHICS HIGH FRAME WIDE ANGLE MICROSCOPE MACRO INFINITE	<b>IMAGE &gt; MODE</b> Use ▲ or ▼ to select between Text, Graphics and High Frame enhancement mode and then <b>ENTER</b> to make a selection. <b>Text</b> - corrects the intensity of the adjacent pixel making it more uniform producing sharper and clearer images. <b>Graphics</b> - adjusts the gradient of the adjacent pixel making it appears to have a smooth image. <b>High Frame</b> - increases the frame rate capture and can visually tracks the motion and react quickly. Sufficient lighting is required when using this mode. <b>Wide Angle</b> - extends the area of visibility up to 400mm x 300mm shooting area. <b>Microscope</b> - automatically fixes the optical zoom and displays the microscope image more clearly. <b>Macro</b> - improves the ability to view small details and

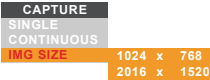
OSD Menu	Description
	<p>get close-up view from the subject in the range of 5 to 20cm.</p> <p><b>Infinite</b> - set to view the subject far away from the camera in the range of 55cm and beyond.</p>
	<p><b>IMAGE &gt; EFFECT</b></p> <p>Use ▲ or ▼ to select and display the image in Camera mode into positive (true color), monochrome (black and white) or negative. Then press <b>ENTER</b> to make a selection.</p>
	<p><b>IMAGE &gt; REVERSE</b></p> <p>Press <b>ENTER</b> to turn off/on REVERSE. Reverse rotates the image by 180° in Camera mode.</p>
	<p><b>IMAGE &gt; MIRROR</b></p> <p>Press <b>ENTER</b> to turn off/on MIRROR. Mirror flips the image in Camera mode.</p>
	<p><b>IMAGE &gt; MANUAL FOCUS</b></p> <p>Use ◀ or ▶ to manually adjust the focus and then press <b>ENTER</b> to save the setting and exit.</p>
	<p><b>IMAGE &gt; EXPOSURE</b></p> <p>Use ▲ or ▼ to select between AUTO or MANUAL. Then press <b>ENTER</b> to make a selection.</p> <p><b>AUTO</b> to automatically adjust the camera exposure to determine how much light is required.</p> <p><b>MANUAL</b> to manually adjust the exposure level. Press <b>ENTER</b> and the bar will turn red, use ◀ &amp; ▶ to increase and decrease the exposure level, and then press <b>ENTER</b> to save the setting and the bar will turn white. Press <b>MENU</b> to close the menu.</p>
	
	<p><b>IMAGE &gt; WHITE BALANCE</b></p> <p>Use ▲ or ▼ to select between auto or manually adjust the red and blue color to suit the lighting condition or color temperature. Then press <b>ENTER</b> to make a selection.</p> <p>To manually adjust the red or blue color level, select <b>RED</b> or <b>BLUE</b>, press <b>ENTER</b> and the bar will turn red, use ◀ &amp; ▶ to increase and decrease the level, and then press <b>ENTER</b> to save the setting and the</p>

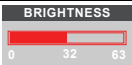
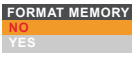
OSD Menu	Description
	<p>bar will turn white.</p>  
	<p><b>IMAGE &gt; CAPTURE</b></p> <p>Use ▲ or ▼ to select <b>SINGLE</b> or <b>CONTINUOUS</b> capture mode and <b>IMG SIZE</b> to select the capture pixel size of the image.</p> <p>Select <b>SINGLE</b> to save one still image only and <b>CONTINUOUS</b> to save successive still images until the built-in memory is full or when the <b>CAP/DEL</b> button is being press again to stop.</p> <p>In Continuous mode, press <b>ENTER</b> the bar will turn red, use ◀ &amp; ▶ to increase and decrease the capture time interval between frames and then press <b>ENTER</b> to save the setting and the bar will turn white. The time interval can be set from 5 to 600 sec.</p>  <p>In <b>IMG SIZE</b>, press <b>ENTER</b>, use ▲ and ▼ to make a selection, and press <b>ENTER</b> to save the setting.</p> 
	<p><b>IMAGE &gt; NIGHT VIEW</b></p> <p>Use ▲ or ▼ to turn Night View <b>OFF</b> or <b>AUTO</b>.</p> <p>If you are presenting in a low-light condition, Night View enables the image of the object to appear as though under normal lighting conditions. CP355 can automatically adjust the exposure to compensate for the adverse condition, but the captured image will appear to be in slow motion.</p>
	<p><b>SETTING &gt; CONTRAST</b></p> <p>Use ◀ or ▶ to emphasize or reduce the difference between light and dark conditions then press <b>ENTER</b>. The contrast level can be adjustable up to 255.</p>
	<p><b>SETTING &gt; BRIGHTNESS</b></p> <p>Use ◀ or ▶ to increase or decrease the brightness level and improve the visibility of the image then press <b>ENTER</b>. The brightness level can be set up to 63.</p>
	<p><b>SETTING &gt; FORMAT MEMORY</b></p> <p>Use ▲ or ▼ to select <b>NO</b> to exit or <b>YES</b> to format and delete all the images saved in the built-in memory then press <b>ENTER</b>.</p>



## OSD Menu

## Description

Please wait till the message "FORMAT" at the lower right corner of the screen disappear to finish the process.

## RESOLUTION

1024 X 768  
800 X 600  
640 X 480  
1280 X 720

## SETTING &gt; RESOLUTION

Use ▲ or ▼ to choose from different supported display resolutions then press **ENTER** to make the selection. This selection will be disabled in TV output mode.

## LANGUAGE

ENGLISH  
ESPAÑOL  
日本語  
繁體中文

## SETTING &gt; LANGUAGE

Use ▲ or ▼ to select from different supported languages then press **ENTER** to make the selection.

## USB CONNECTION

USB CAMERA  
IMG DOWNLOAD

## SETTING &gt; USB CONNECTION

Use ▲ or ▼ buttons to select the function of USB between USB CAMERA and IMG DOWNLOAD. Then press **ENTER**.

USB Camera - can be used as a computer webcam or with our bundled software to record video and capture still image.

Img Download - transfer the captured images from the built-in memory to computer hard disk.

## FLICKER

50 HZ  
60 HZ

## SETTINGS &gt; IMAGE &gt; EXPOSURE &gt; FLICKER

Use ▲ or ▼ to select between 50Hz or 60Hz. Some display devices cannot handle high refresh rates. The image will flicker a couple of times as the output is switched to another refresh rate.

## DEFAULT

NO  
YES

## DEFAULT

Use ▲ or ▼ to select **YES** to restore to original factory default setting or **NO** to exit then press **ENTER** to make the selection.

## IMAGE MENU

IMAGE	MENU	SETTING
CONTRAST		92
BRIGHTNESS		32
FORMAT MEMORY		NO
RESOLUTION		1024 X 768
LANGUAGE		ENGLISH
USB CONNECTION		USB CAMERA
FLICKER		60 HZ
DEFAULT		NO
PROFILE		OFF

## SETTING &gt; PROFILE

Press **ENTER** and use ▲ or ▼ to select between **SAVE** or **RECALL**. Then press **ENTER** again to make a selection.

**SAVE** - store the current setting in the selected profile number. Only effect, mode, brightness and contrast settings can be saved.

**RECALL** - restore the setting back to the selected profile number.

In the SAVE/RECALL selection, use ▲ or ▼ to select saving/restoring the setting from the three profile number then press **ENTER**.

PROFILE	
SAVE	PROFILE 1
RECALL	PROFILE 2
	PROFILE 3

PROFILE	
SAVE	PROFILE 1
RECALL	PROFILE 2
	PROFILE 3

## RS-232C Diagram Connection

CP355 can be controlled using a PC through RS-232 connection.

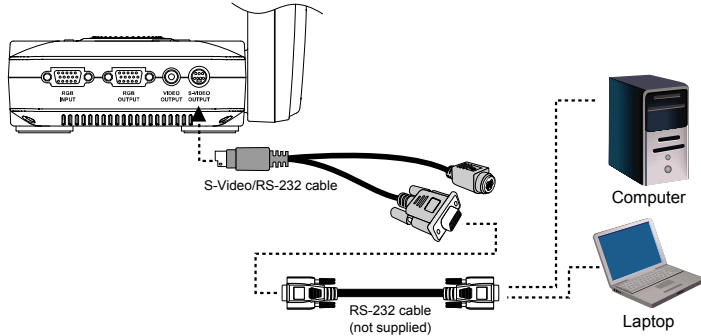

## RS-232C Cable Spec

Make sure the RS-232 cable matches the cable spec design.

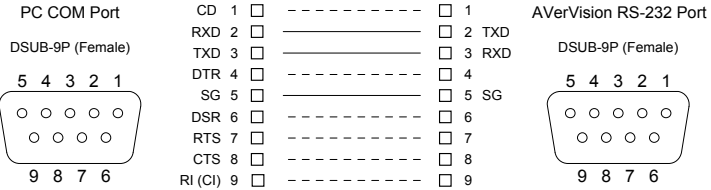

## RS-232C Transmission Spec

- Start bit : 1 bit
- Data bit : 8 bit
- Stop bit : 1 bit
- Parity bit : None
- X parameter : None
- Baud rate(Communication speed) : 9600bps

## RS-232C Communication Format

Start Code(1 Byte) : 0xFF  
 Type Code(1 Byte) : 0x70  
 DataLength Code(1 Byte) : 0x01  
 Data Code(1 Byte) : See the Command Table for reference.  
 CheckSum Code(1 Byte) : See the Command Table for reference.  
 Format : Start + Type + DataLength + Data + CheckSum  
 Example : 0xFF + 0x70 + 0x01+ 0x1 + 0x70 (Command Power)

## RS-232C Command Table

Function	Start	Type	Data Length	Data	Checksum
POWER	FF	70	1	1	70
ENTER	FF	70	1	2	73
UP	FF	70	1	3	72
DOWN	FF	70	1	4	75
LEFT	FF	70	1	5	74
RIGHT	FF	70	1	6	77
PLAYBACK	FF	70	1	7	76
MENU	FF	70	1	8	79
PC/CAMERA	FF	70	1	9	78
AUTOIMAGE	FF	70	1	A	7B
AUTOFOCUS	FF	70	1	B	7A
FREEZE	FF	70	1	C	7D
CAPTURE	FF	70	1	D	7C
REVERSE	FF	70	1	E	7F
TIMER	FF	70	1	F	7E
EFFECT	FF	70	1	10	61
PBP	FF	70	1	11	60
PRESENTER	FF	70	1	12	63
PIP	FF	70	1	13	62
POWER ON	FF	70	1	40	31
POWER OFF	FF	70	1	41	30

## Transferring the Captured Image to PC

This enables you to transfer the captured image from the built-in memory to PC.



The instruction below **MUST** be read and followed **BEFORE** connecting the USB cable.

1. **MUST** set the USB CONNECTION as IMG DOWNLOAD before connecting the USB cable.

To set the USB CONNECTION as IMG DOWNLOAD, press **MENU** > select **USB CONNECTION** in SETTING menu list and press **ENTER**, select **IMG DOWNLOAD** and press **ENTER**.

2. When "IMG DOWNLOAD" appears at the lower right corner of the presentation screen, you may now connect the USB cable.
3. Upon connecting the USB cable, the system automatically detects the new removable disk. You may now transfer the captured image(s) from the CP355 built-in memory to PC hard disk.

## Troubleshooting

This section provides many useful tips on how to solve common problems while using the CP355.

### **There is no picture on the presentation screen.**

1. Check all the connectors again as shown in this manual.
2. Check the on/off switch of the display output device.
3. Verify the setting of the display output device.
4. If you are presenting from a notebook or computer through the display output device, check the cable connection from computer RGB (VGA) output to RGB input of CP355 and make sure CP355 is in PC Mode.

### **I have set up the CP355 and checked all the connections as specified in the manual but I cannot get a picture on the preferred presentation screen.**

1. The unit POWER button turns orange in standby mode. Press the POWER button again to turn on and the LED light will turn blue.
2. The default camera display resolution setting is on 1024x768. If your output device does not support this resolution; no image can be projected. Simply press hold the MENU and ► button to the change the resolution setting.
3. If your display output device is on TV or any analog device, please switch the TV-RGB dip switch to TV.

### **The picture on the presentation screen is distorted or the image is blurry.**

1. Reset all changed settings, if any, to the original manufacturer default setting (Refer to the Menu Functions for more details and steps).
2. Use the Brightness and Contrast menu functions to reduce the distortion if applicable.
3. If you discover that the image is blurry or out of focus, press the Auto Focus button on the control panel or remote control.

### **There is no computer signal on presentation screen.**

1. Check all the cable connections among the display device, CP355 and your PC.
2. Connect your PC to the CP355 first before you power on your computer.
3. For notebook, repeatedly press FN+F5 to toggles between display modes and display the computer image on the presentation screen. For different command, please refer to your laptop manual.

### **The presentation screen does not show the exact desktop image on my PC or Notebook after I toggle from Camera to PC mode.**

1. Return to your PC or Notebook, place the mouse on the desktop and right click, choose "Properties", choose "Setting" tab, click on "2" monitor and check the box "Extend my Windows desktop onto this monitor".
2. Then go back one more time to your PC or Notebook and place the mouse on the desktop and right click again.
3. This time choose "Graphics Options", then "Output To", then "Intel® Dual Display Clone", and then choose "Monitor + Notebook".
4. After you follow these steps, you should be able to see the same desktop image on your PC or Notebook as well as on the presentation screen.

**How do I transfer the images from CP355 to a computer? Is it normal that CP355 will reset to camera mode after I download images and disconnect the USB cable?**

Choose "IMG DOWNLOAD" in SETTING tab, USB CONNECTION menu, and then connect the USB cable to transfer the captured images from the CP355 to the computer. When finished, unplug the USB cable. The CP355 will automatically reset and switch to camera mode.

## Limited Warranty

For a period of time beginning on the date of purchase of the applicable product and extending as set forth in the "**Warranty Period of AVerMedia Product Purchased**" section of the warranty card, AVerMedia Information, Inc. ("AVerMedia") warrants that the applicable product ("Product") substantially conforms to AVerMedia's documentation for the product and that its manufacture and components are free of defects in material and workmanship under normal use. "You" as used in this agreement means you individually or the business entity on whose behalf you use or install the product, as applicable. This limited warranty extends only to You as the original purchaser. Except for the foregoing, the Product is provided "AS IS." In no event does AVerMedia warrant that You will be able to operate the Product without problems or interruptions, or that the Product is suitable for your purposes. Your exclusive remedy and the entire liability of AVerMedia under this paragraph shall be, at AVerMedia's option, the repair or replacement of the Product with the same or a comparable product. This warranty does not apply to (a) any Product on which the serial number has been defaced, modified, or removed, or (b) cartons, cases, batteries, cabinets, tapes, or accessories used with this product. This warranty does not apply to any Product that has suffered damage, deterioration or malfunction due to (a) accident, abuse, misuse, neglect, fire, water, lightning, or other acts of nature, commercial or industrial use, unauthorized product modification or failure to follow instructions included with the Product, (b) misapplication of service by someone other than the manufacturer's representative, (c) any shipment damages (such claims must be made with the carrier), or (d) any other causes that do not relate to a Product defect. The Warranty Period of any repaired or replaced Product shall be the longer of (a) the original Warranty Period or (b) thirty (30) days from the date of delivery of the repaired or replaced product.

### Limitations of Warranty

AVerMedia makes no warranties to any third party. You are responsible for all claims, damages, settlements, expenses, and attorneys' fees with respect to claims made against You as a result of Your use or misuse of the Product. This warranty applies only if the Product is installed, operated, maintained, and used in accordance with AVerMedia specifications. Specifically, the warranties do not extend to any failure caused by (i) accident, unusual physical, electrical, or electromagnetic stress, neglect or misuse, (ii) fluctuations in electrical power beyond AVerMedia specifications, (iii) use of the Product with any accessories or options not furnished by AVerMedia or its authorized agents, or (iv) installation, alteration, or repair of the Product by anyone other than AVerMedia or its authorized agents.

### Disclaimer of Warranty

EXCEPT AS EXPRESSLY PROVIDED OTHERWISE HEREIN AND TO THE MAXIMUM EXTENT PERMITTED BY APPLICABLE LAW, AVERMEDIA DISCLAIMS ALL OTHER WARRANTIES WITH RESPECT TO THE PRODUCT, WHETHER EXPRESS, IMPLIED, STATUTORY OR OTHERWISE, INCLUDING WITHOUT LIMITATION, SATISFACTORY QUALITY, COURSE OF DEALING, TRADE USAGE OR PRACTICE OR THE IMPLIED WARRANTIES OF MERCHANTABILITY, FITNESS FOR A PARTICULAR PURPOSE OR NONINFRINGEMENT OF THIRD PARTY RIGHTS.

**Limitation of Liability**

IN NO EVENT SHALL AVERMEDIA BE LIABLE FOR INDIRECT, INCIDENTAL, SPECIAL, EXEMPLARY, PUNITIVE, OR CONSEQUENTIAL DAMAGES OF ANY NATURE INCLUDING, BUT NOT LIMITED TO, LOSS OF PROFITS, DATA, REVENUE, PRODUCTION, OR USE, BUSINESS INTERRUPTION, OR PROCUREMENT OF SUBSTITUTE GOODS OR SERVICES ARISING OUT OF OR IN CONNECTION WITH THIS LIMITED WARRANTY, OR THE USE OR PERFORMANCE OF ANY PRODUCT, WHETHER BASED ON CONTRACT OR TORT, INCLUDING NEGLIGENCE, OR ANY OTHER LEGAL THEORY, EVEN IF AVERMEDIA HAS ADVISED OF THE POSSIBILITY OF SUCH DAMAGES. AVERMEDIA'S TOTAL, AGGREGATE LIABILITY FOR DAMAGES OF ANY NATURE, REGARDLESS OF FORM OF ACTION, SHALL IN NO EVENT EXCEED THE AMOUNT PAID BY YOU TO AVERMEDIA FOR THE SPECIFIC PRODUCT UPON WHICH LIABILITY IS BASED.

**Governing Law and Your Rights**

This warranty gives You specific legal rights; You may also have other rights granted under state law. These rights vary from state to state.



For warranty period, please refer to the warranty card.

---