

BK PRECISION®

Instruction Manual

Model 1251B Deluxe NTSC/PAL Signal Generator

TABLE OF CONTENTS

1 GENERAL	1
1.1 Description	1
1.2 Specifications	3
2 SAFETY RULES	9
3 INSTALLATION	11
3.1 Power requirements	11
3.2 Grounding	12
3.3 Installation and start-up	12
4 OPERATING INSTRUCTIONS	13
4.1 Control description	13
4.2 Using the 1251B	14
4.2.1 Selection of TV standard	15
4.2.2 Storing a configuration	16
4.2.3 Retrieving a configuration	17
4.2.4 Rotary selector	17
4.2.5 Chart selection	18
4.2.6 Channel selection	18
4.2.7 Frequency selection	18
4.2.8 Application of test pictures	18
4.3 Function buttons which modify the composite video signal	20
4.4 Function buttons which modify the sound modulation	21
4.5 Function buttons which operate on the Teletext and VPS signals	21
5 DESCRIPTION OF INPUTS AND OUTPUTS	23
5.1 Composite video output (BNC)	23
5.2 Modulated RF output	23
5.3 Synchronisms output	23
5.4 Trigger oscilloscope	24
5.5 R-G-B outputs	24
5.6 LF sound input	24
5.7 S-VHS output	25
5.8 Euroconnector	26
6 PRINCIPLES OF OPERATION	27
6.1 Circuit description	27
7 MAINTENANCE	31
7.1 Replacing the mains fuse	31
7.2 Cleaning recommendations	31

TV SIGNAL GENERATOR

1251B

1 GENERAL

1.1 Description

The 1251B TV signal generator is a multi-standard, multi-system unit with advanced functions. It has been designed using the most modern technology resulting in great reliability and reduced consumption. Its modular structure makes it highly versatile and permits rapid access to all its components. Starting from base modules, it is possible to increase the applications of the instrument by adding modules if desired.

The 1251B is particularly suitable for those industrial sectors that require high-quality pictures such as adjustment and analysis lines, production studios, technical assistance services, etc. In addition, being easy to operate, it is indispensable in the training of video technicians.

The 1251B operates in accord with the CCIR/OIRT recommendations for the color systems PAL-SECAM and FCC for the NTSC system and may provide a modulated signal for practically all the transmission standards presently in use. The video is equipped with 32 pattern charts to analyze the picture visually or with an oscilloscope. For geometric adjustments, the electronic circle can be inserted in all the charts.

To detect defects in the tuning circuits and IF amplifier stages, the 1251B has a complete radio-frequency modulator, its principal characteristics being:

- Frequency range from 37 to 865 MHz
- Synthesized frequency output
- Tuning by channels or by frequency (in steps of 50 kHz)
- Attenuation of output RF signal up to 50 dB (in steps of 10 dB)

The VTR (Video Text Recorder) function is available to check the functioning of video tape recorders, particularly the functions of "still", stepped image, heads position, etc.

Microprocessor control, the presentation of information on a wide illuminated alphanumeric display and the incorporation of a single rotary selector for all the functions results in simple and easy operation. The functions controlled are:

- Selection and display of RF by channel or by frequency
- Selection of the color system and sound standard
- Selection of the output chart
- Storage of up to 32 different programs is possible. Each program (chart/system-sound standard/frequency or RF channel) may be stored or retrieved at any time.

Internal (1 kHz/3 kHz) or external modulation of sound is possible. For a superior analysis of the video and sound signal, there are push-buttons for cancelling or including certain basic functions, such as:

- Independent cancellation of the color subcarrier and of the burst
- Inclusion of the electronic circle
- Cancellation of the interlace in the video signal
- Cancellation of the sound subcarrier
- Selection of stereo or dual sound
- Independent cancellation of L and R sound
- Cancellation of the TELETEXT and VPS signal
- Selection of the information to transmit in the VPS signal

On the front panel there is an adjustable composite video output and an RF output with an attenuator of up to 50 dB. In addition, numerous auxiliary inputs and outputs increase the possibilities of the instrument considerably. These supplementary connectors are located on the rear panel:

- S-VHS output
- R, G and B (or G plus synchronisms) outputs
- Composite synchronisms output
- Synchronisms output for an oscilloscope
- L and R sound input
- In the Euroconnector:
 - Composite video output
 - R, G, B (or G plus synchronisms) outputs
 - L and R sound inputs and outputs
 - Video input (external signal modulation)

The 1251B has a series of functions which may be optionally included (see the list of versions and options under item 1.2 of the specifications).

- Generator module of the TELETEXT and VPS signals. During recent years, there has been a growing acceptance of TELETEXT on the part of users, and the majority of television sets incorporate it. With the 1251B, it is possible to generate 8 pages in two languages, which can be selected from the television set (by number or by means of the FLOF or FASTEXT function), with different combinations of graphics and text in 1.0 and 1.5 levels which permit the verification of all the decoding functions.
The VPS signal (Video Program Service) is an information signal, which is emitted by television channels during a program, that may activate or stop the users' video recorders if they are equipped with this feature. This eliminates the problems caused by changes in the programming to be recorded.
- Generator module of the stereo/dual (Zweiton) signal either generates a second sound carrier to be used as a second mono sound channel, or provides the right channel stereo information. This signal, like the main carrier, may be modulated by an external signal.
- Generator module of the NICAM signal for PAL G and I. The demand for better quality sound in television systems has resulted in the appearance of digital coding of sound. This module enables the testing of equipment which has this feature.

1.2 Specifications 

The values indicated with tolerances are guaranteed by the manufacturer, those without are to be nominally expected within a group of identical instruments. Specifications are valid 10 minutes after switching on.

TV SYSTEM

System	PAL/SECAM	NTSC
RF Standard	B,G,H,D,K,K1,I,L	M
No. of lines/frame	625	525
Field frequency	50 Hz	60 Hz
Line frequency	15625 Hz	15734 Hz
Horizontal synchronism		
Line period (1/f _H)	64 μs ± 100 ns	63.56 μs ± 100 ns
Front porch	1.6 μs ± 100 ns	1.59 μs ± 100 ns
Synchronism	4.8 μs ± 100 ns	4.77 μs ± 100 ns
Blanking	12 μs ± 100 ns	11.12 μs ± 100 ns
Vertical synchronism		
Frame period	20 ms ± 100 ns (H = 64 μs)	16.68 ms ± 100 ns (H = 63.56 μs)
Blanking	25 H + 12 μs	21 H + 11.12 μs
Duration of impulse of:		
Pre-equalization	2.5 H	3 H
Equalization	2.5 H	3 H
Post-equalization	2.5 H	3 H
Scanning of picture	Selectable: Interlaced ratio 2:1 Not interlaced	
PAL (B,G,H,D,I) color subcarrier		
Frequency	4.43361875 MHz <± 30 ppm (10°C to 40°C)	
Burst duration	2.4 μs (10 ± 1 period of F _{sc})	
Burst position	5.6 μs ± 100 ns from the line previous synchronism flank.	
Phase	± 135° referred to the U axis with the sequence	
	<u>Line</u>	<u>Frame</u>
		1 2 3 4
	Even	- - + +
	Odd	+ + - -
Amplitude error	± 5 %	
Phase error	± 3 %	
Burst amplitude	ON/OFF, selectable	
Subcarrier amplitude	ON/OFF, selectable	

NTSC (M) color subcarrier

Frequency	3.579545 MHz $\leq \pm 30$ ppm (10°C to 40°C)
Burst duration	2.38 μ s (10 \pm 1 period of Fsc)
Burst position	5.56 μ s \pm 100 ns from the line previous synchronism flank.
Phase	- 180° referred to the U axis
Amplitude error	± 5 %
Phase error	± 3 %
Burst amplitude	ON/OFF, selectable
Subcarrier amplitude	ON/OFF, selectable

SECAM (B,G,H,D,K,K1,L) color subcarrier (Version /3,/5,/11)

Subcarrier frequency	For = 4.406250 MHz ± 2 kHz
(sinc. f _H)	Fob = 4.250000 MHz ± 2 kHz
Identification pulses	
Frame (position)	Line 7 to 15 in odd fields Line 320 to 328 in even fields
Frequency	Dr = 4.756250 MHz ± 35 kHz Db = 3.900000 MHz ± 35 kHz
Frame	Selectable ON/OFF with interlace button
Line	Selectable ON/OFF with burst button
Chrominance signal	
Amplitude	D'r = -1.9 (E'r - E'y) D'b = 1.5 (E'b - E'y)
Pre-correction of chrominance	Bell filter
Central frequency of Bell filter	4.286 MHz ± 0.020 MHz

DISPLAY

Digital, 16 characters, with chart, TV standard/sound system, channel and frequency (5 digits) indications. Program indicated in the Store/Recall mode.

RADIO-FREQUENCY OUTPUT

Range covered	37 to 865 MHz (synthesized)
Tuning	By frequency: in steps of 50 kHz By channels: CCIR (FCC Version /1,/6,/8)
Store/recall	32 programs
Frequency indicator	5 digits
Output amplitude	90 dB μ V ± 3 dB
Attenuation	50 dB (in steps of 10 dB)
Impedance	75 Ω
Connector	BNC

VIDEO MODULATION

Modulation type	AM, double side band
Modulation index	85% (internal modulation)

VIDEO OUTPUT

Impedance	75 Ω
Amplitude	Variable from 0 to 1.2 V
Nominal value	1 V
Polarity	Positive
Coupling	Direct coupling
Blanking cont.lev.	0 V (nominal)
Connector	BNC or Euroconnector

Y-C (S-VHS) OUTPUT COMPONENTS

Impedance	75 Ω
Amplitude	0.7 V (max. white level luminance) 0.3 V (color burst)
Connector	S-VHS

R-G-B OUTPUTS

Impedance	75 Ω
Amplitude	0.7 Vpp
G synchronisms	0.3 Vpp (selectable ON/OFF)
Connector	BNC or Euroconnector

SYNCHRONISMS OUTPUT

Impedance	75 Ω
Amplitude	2.0 Vpp
Polarity	Positive or negative (selectable)
Connector	BNC

OSCILLOSCOPE TRIGGER OUTPUT

Impedance	75 Ω
Amplitude	2.0 Vpp vertical, 1.5 Vpp horizontal
Connector	BNC

SOUND OUTPUT

Impedance	1 k Ω
Amplitude	0.4 Vpp
Connector	Euroconnector

VIDEO INPUT

Impedance	10 k Ω
Coupling	Direct coupling
Connector	Euroconnector

EXTERNAL L.F. SOUND INPUT

Impedance	100 k Ω
Amplitude	Max. 0.5 Vpp
Bandwidth	100 Hz to 15 kHz
Connector	DIN 41524 or Euroconnector

SOUND MODULATION (MULTISTANDARD-MONO)

Carrier	ON/OFF selectable	
(sinc. f_H)		
Frequency	4.5 MHz	(M)
	5.5 MHz	(B,G,H)
	6.0 MHz	(I)
	6.5 MHz	(D,K,K1,L)
Video/sound carrier ratio	13 dB	
Type of modulation (selectable)	Int. FM (1 kHz) (M,B,G,H,D,K,K1,I)	
	Ext. FM	
	AM	(L)
FM modulation		
Pre-emphasis	50 μ s	(B,G,H,D,K,K1,I)
	75 μ s	(M)
Modulation deviation	30 kHz	(in FM)
Modulation index	50 %	(in AM)

MODULATION OF STEREO/DUAL SOUND (ZWEITON)

Carrier	ON/OFF selectable	
Sinc. f_H	Carrier 1	Carrier 2
Frequency	5.5 MHz	5.7421875 MHz
Video/sound carrier ratio	13 dB	20 dB
Type of modulation (selectable)	Int. FM (1 kHz)	int. FM (3 kHz)
	Ext. FM	Ext. FM
	Max. 0.5 Vpp	Max. 0.5 Vpp
Pre-emphasis	50 μ s	50 μ s
Modulation deviation	30 kHz	30 kHz
Mode		
Dual	L	R
Stereo	(L+R)/2	R
Detection mode		
Pilot frequency	54.6875 kHz	(3.5* f_H)
Modulation	AM	
Modulation index	50 %	
Identif. frequency	274.1 Hz ($f_H/57$) dual	
	117.5 Hz ($f_H/133$) stereo	

MODULATION OF NICAM SOUND

Carrier	ON/OFF selectable	
PAL B,G, L	5.850 MHz	< \pm 30 ppm
PAL I	6.552 MHz	< \pm 30 ppm
Carrier ratio video/sound	20 dB (B,G,I), 26 dB (L)	
Modulation	4QPSK	
Modes	Mono, dual, stereo	
Internal sources		
Channel 1	1 kHz, ON/OFF selectable	
Channel 2	3 kHz, ON/OFF selectable	

Sound reserve flag	ON
Signal coding	32 samples/block 16 blocks.
Transmission speed	728 kbits/s
Pre-emphasis	In accord with CCITT Rec. J17
Spectrum form	40% roll-off cosine (PAL B,G,) 100% roll-off cosine (PAL I)

TELETEXT GENERATOR (LEVEL 1.0 & 1.5) AND VPS

Teletext (sinc. f_H)	ON/OFF selectable
Frequency	6.9375 MHz ($444 \cdot f_H$)
Transmission mode	NRZ (no return to zero)
Data lines	From 11 to 15 and 19 to 22 in odd fields From 324 to 329 and 332 to 335 in even fields
Content	8 different pages (two languages sent consecutively).
VPS	ON/OFF selectable
Frequency	5.0 MHz
Transmission mode	Biphase
Data line	16 odd field
Content	Selectable through change of chart apart from the functions stop, start and standby which are selected through the keyboard.
"0" Level	Black level
"1" Level	66% \pm 5% of the white level
Connector	Signal output together with the composite video by BNC and Euroconnector.

LOGOTYPE GENERATOR

Window position	Charts A1 and A4 (logotypes) Charts A3 and C1 (VTR)
-----------------	--

VIDEO TEST RECORDER (VTR)

VTR format	8-position mobile rectangle
Velocity	1 position per image field

POWER SUPPLY

Mains voltage	AC 110-125-220-230-240 V \pm 10% 50-60 Hz
Power consumption	20 W

OPERATING ENVIRONMENTAL CONDITIONS

Altitude	Up to 2000 m
Temperature range	From 5 to 40 °C
Maximum relative humidity	80% (up to 31 °C), decreasing linearly up to 50% at 40 °C.

MECHANICAL FEATURES

Dimensions	W.11.4" x H.4.1" x D.9.8" (288 x 102 x 247 mm)
Weight	6.7 lbs (3 kg)

ACCESSORIES INCLUDED

BNC/TV coaxial cable
Mains cable
1A F 250 V spare fuse

NOTE: According to PROMAX's information the NICAM sound transmission system has by now been adopted by the following countries:











NICAM B/G	NICAM I	NICAM L
Spain	United Kingdom	France
Portugal	South Africa	
Sweden	Ireland	
Norway	Hong Kong	
Denmark		
Iceland		
Finland		
Singapore		
New Zealand		

2 SAFETY RULES

- * Use this equipment connected **only to devices or systems with their common at ground potential.**
- * This is a **class I** equipment, for safety reasons plug it to a supply line with the corresponding **ground terminal.**
- * This equipment can be used in CATEGORY II installations and Pollution Degree 1 environments.
- * When using some of the following accessories **use only the specified ones** to ensure safety.
- * Power cord
- * Observe all **specified ratings** both of supply and measurement
- * Remember that voltages higher than 60V DC or 30V AC rms are dangerous
- * Use this instrument under the **specified environmental conditions**
- * **The user is only authorized to** carry out the following maintenance operations:
 - To replace the mains fuse of the specified type and value
 - To replace the logo EPROM

On the Maintenance paragraph the proper instructions are given. Any other change on the equipment should be carried out by qualified personnel.
- * **The Measure negative** is at ground potential
- * **Do not obstruct the ventilation system**
- * Follow the **cleaning instructions** described in the Maintenance paragraph

* Symbols related with safety:

	DIRECT CURRENT
	ALTERNATING CURRENT
	DIRECT AND ALTERNATING
	GROUND TERMINAL
	PROTECTIVE CONDUCTOR
	FRAME TERMINAL
	EQUIPOTENTIALITY
	ON (Supply)
	OFF (Supply)
	DOUBLE INSULATION PROTECTED (Class II Protection)
	CAUTION (Risk of electric shock)
	CAUTION REFER TO ACOMPANYING DOCUMENTS
	FUSE

3 INSTALLATION

3.1 Power requirements

This equipment requires a mains power source of 110-125-220 or 230/240 V AC 50 to 60 Hz. Mains operating voltage can be selected at the rear panel.

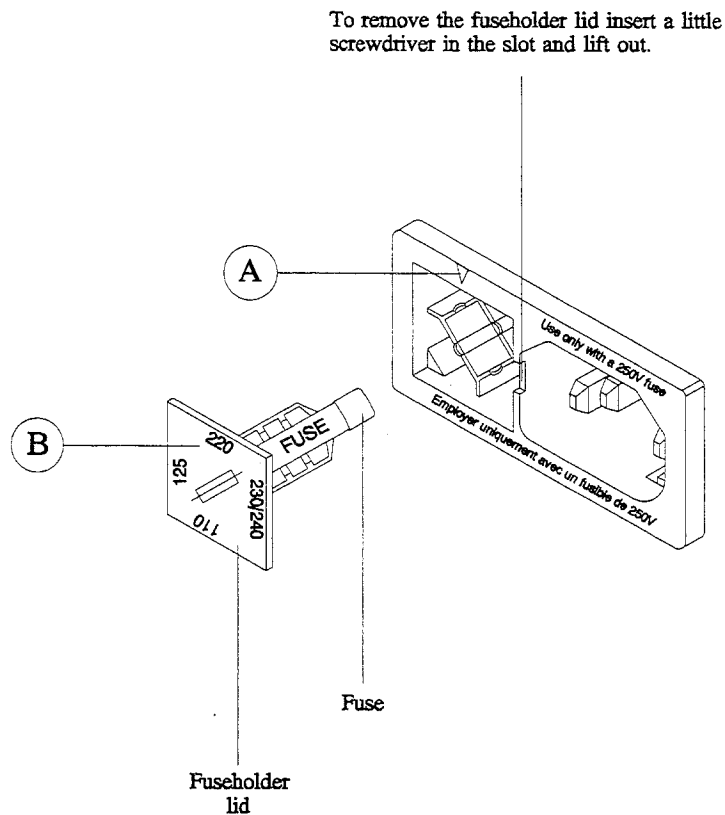

Figure 1.- Selection of mains voltage.

- 1.- Pull out the fuseholder lid.
- 2.- Set the proper fuse for the desired mains voltage.
- 3.- Insert the fuseholder lid so the [A] pointer faces the desired mains voltage display [B].

CAUTION:
THE EQUIPMENT IS FACTORY SET FOR 110 V OPERATING VOLTAGE.

BEFORE SWITCHING ON THIS INSTRUMENT, SET THE VOLTAGE SELECTOR TO THE PROPER POSITION AND BE SURE THAT THE FUSE VALUE IS ACCORDING TO THE MAINS VOLTAGE.

FUSE TYPE SHOULD BE: 5 x 20 mm., 250 V.

0.5 A F FOR 220, 230 and 240 V

1 A F FOR 110 and 125 V

AVOIDING THESE DIRECTIONS COULD DAMAGE THE EQUIPMENT

3.2 Grounding

In order to guarantee safe operation of the 1251B, a suitable connector is provided on the rear panel for connection to GROUND (Mains Connector [35]).

ATTENTION

Any equipment manufactured with a power supply connected to the chassis and which is to be connected to the 1251B must be supplied with an adequate isolating transformer. Non-observance of this norm may cause damage to the instrument and/or produce damage to the operator.

3.3 Installation and start-up

The equipment is prepared for use as desk-top equipment.

After having selected the power supply voltage, the equipment may be connected to the mains and switched on by activating the mains switch [1].

The equipment's highest level of performance is obtained at about 10 minutes after switching on. This period stabilizes the components sensitive to the thermal gradient.

ATTENTION

For correct operation of the 1251B, ensure, when connecting the equipment to an external instrument, that the impedances are correctly matched (see item 1.2 of specifications), otherwise incorrect operation may result.

E.g.: in the case of connection to a TV with a balanced R.F. input of 300 Ω impedance, an impedance adaptor should be used.

4 OPERATING INSTRUCTIONS

4.1 Control description

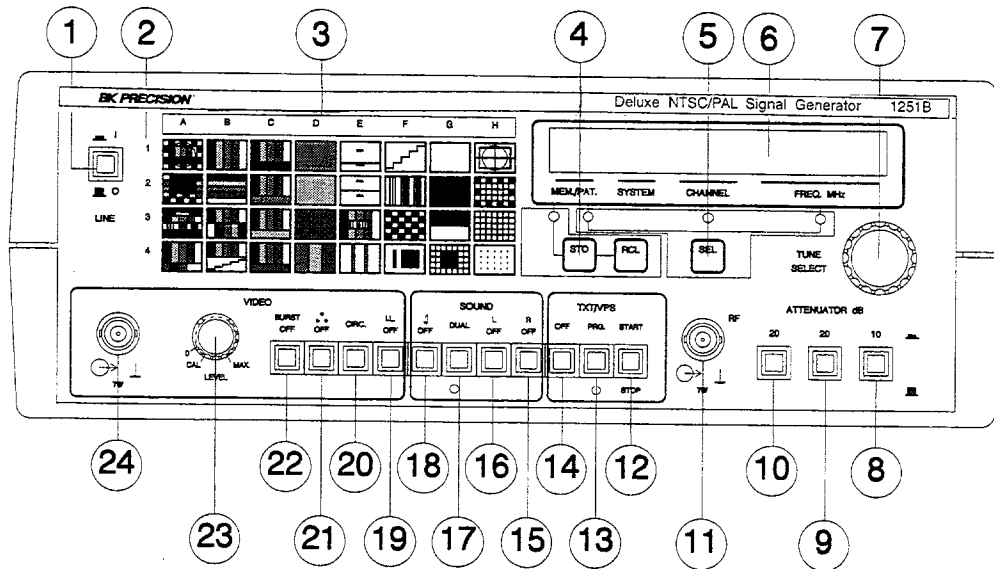

Figure 2.- Front panel.

- [1] **LINE.** Mains switch
- [2] Row indicator
- [3] Column indicator
- [4] **STO, RCL.** Memory selector (recall/store)
- [5] **SEL.** Rotary function selector (chart/system–standard/channel–frequency)
- [6] Alphanumeric display
- [7] **TUNE SELECT.** Rotary selector
- [8] **10.** 10 dB attenuator
- [9] **20.** 20 dB attenuator
- [10] **20.** 20 dB attenuator
- [11] **RF** \rightarrow . RF output
- [12] **START.** VPS signal information (start/stop) selection button
- [13] **PRG.** VPS signal information (program/standby) selection button
- [14] **TXT/VPS OFF.** Teletext and VPS signal suppression button
- [15] **R OFF.** R channel suppression button (stereo sound/dual)
- [16] **L OFF.** L channel suppression button
- [17] **DUAL.** Stereo or dual sound mode selection button.
- [18] \downarrow **OFF.** Sound carrier suppression button
- [19] **IL OFF.** Interlace suppression button
- [20] **CIRC.** Circle addition button

- [21] **•• OFF**. Color suppression button
- [22] **BURST OFF**. Burst suppression button
- [23] **LEVEL**. Video output level control
- [24] **VIDEO** \odot . Video output connector

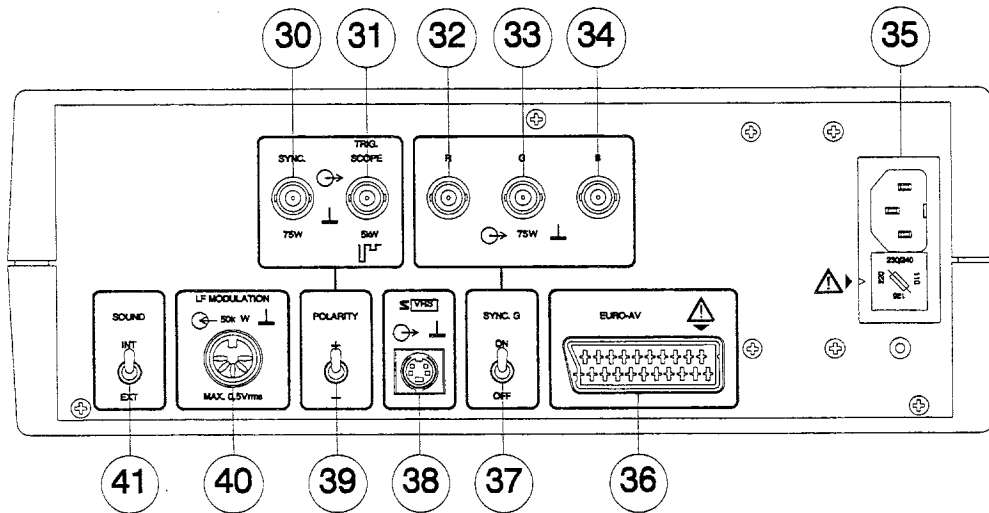

Figure 3.- Rear panel.

- [30] **SYNC** \odot . Synchronisms output
- [31] **TRIG. SCOPE** \odot . Composite signal output for oscilloscope trigger
- [32] **R** \odot . R signal output
- [33] **G** \odot . G signal output
- [34] **B** \odot . B signal output
- [35] Mains input
- [36] **EURO-AV**. Euroconnector connector
- [37] **SYNC. G**. G synchronisms ON/OFF selector
- [38] **S[VHS]**. S-VHS output
- [39] **POLARITY**. Synchronisms output polarity selector
- [40] **LF MODULATION** \odot . External LF input connector
- [41] **SOUND**. Internal/external LF selector

4.2 Using the 1251B

This section explains how to use the 1251B including the operation of the keyboard, the composite video signal, the radio-frequency output and a detailed description of the information appearing on the display.

4.2.1 Selection of TV standard

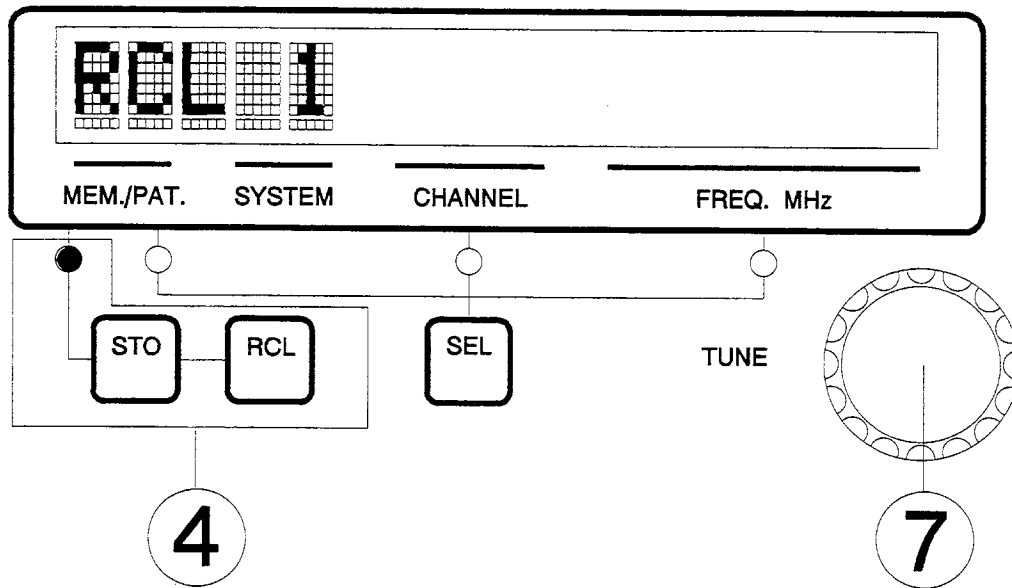

Figure 4.– Selection of TV standard and memory.

To select the desired TV standard follow the instructions below:

- 1) Press simultaneously the STO and RCL buttons corresponding to the group [4]. The data presentation on the alphanumeric display will change: on the left side the abbreviated denomination will appear, and on the right a complete description of the equipment system at that moment.
- 2) Select the desired system by means of the TUNE SELECT rotary selector [7]. The options available are shown on table 1.
- 3) By pressing the SEL button of the group [5] the process will be completed. The alphanumeric display will return to its normal mode and the abbreviation of the system selected will appear in the position corresponding to indication of the system.

ABBREVIAT. DENOMIN.	COMPLETE DENOMINATION	CARRIERS SEPARATION	
		SOUND 1	SOUND 2
Pb	PAL B/G/H	5.5 MHz	-
Pi	PAL I	6.0 MHz	-
Pd	PAL D/K	6.5 MHz	-
Pz	PAL ZWEITON	5.5 MHz	5.742 MHz
P#	PAL I-NICAM	6.0 MHz	6.552 MHz
P*	PAL G-NICAM	5.5 MHz	5.850 MHz
Sb	SECAM B/G/H	5.5 MHz	-
Sd	SECAM D/K/K1	6.5 MHz	-
Sl	SECAM L	6.5 MHz (AM)	-
Nm	NTSC M	4.5 MHz	-
EX	VIDEO EURO-AV	-	-

Table 1

4.2.2 Storing a configuration

To store a configuration follow the instructions below:

- 1) Select all (chart/system-standard/channel-frequency) that which you wish to store (see items 4.2.1, 4.2.5, 4.2.6 and 4.2.7).
- 2) Press the STO button corresponding to the group [4]. The LED situated below the MEM position will light and the message "STO XX" on the display will indicate that this option has been selected, "XX" indicating the number of the memory currently selected.
- 3) Select the memory position in which you wish to store the information by means of the TUNE SELECT [7] rotary selector.
- 4) Press the STO button again, by which the process will be completed.

4.2.3 Retrieving a configuration

Take the following steps to retrieve the desired configuration:

- 1) Press the RCL button corresponding to the group [4]
- 2) The LED situated below the MEM position will light and the message "RCL XX" on the display will indicate that this option has been selected, "XX" indicating the number of the memory currently selected.
- 3) Select the memory position in which you wish to store the information by means of the TUNE SELECT [7] rotary selector.
- 4) Press the RCL button again, by which the process will be completed.

The entire configuration stored (chart/system-standard/channel-frequency) will be updated within the equipment.

4.2.4 Rotary selector

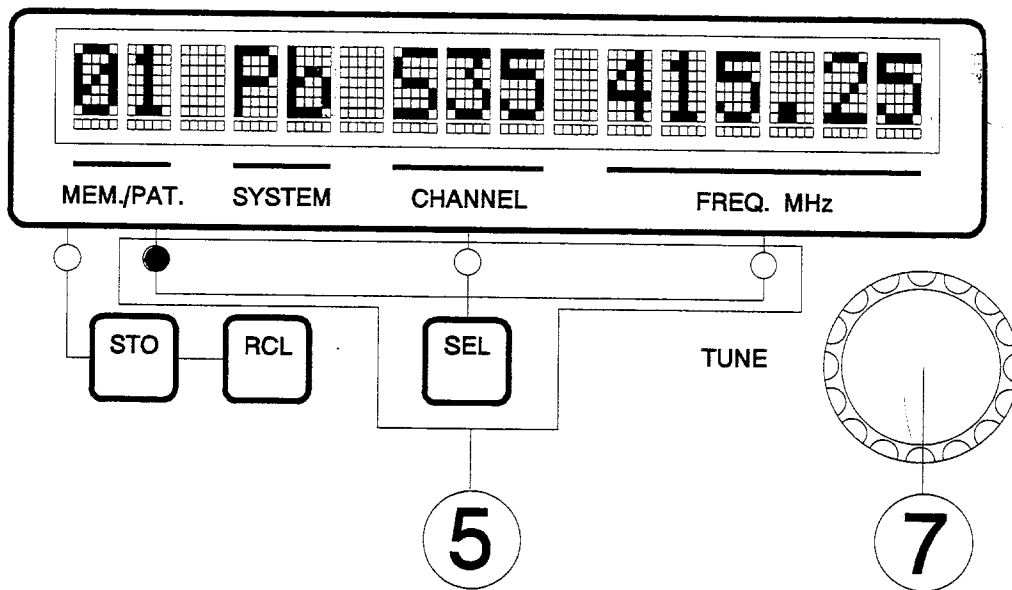

Figure 5.- Selection of the function of the rotary selector.

The TUNE SELECT [7] rotary selector incorporated in the 1251B enables selection of chart, system, standard, channel and frequency to be simply made.

The SEL button in the group [5] permits the selection of the function indicated by the rotary selector. By pressing this button repeatedly, the information corresponding to the type of chart, system, channel and frequency is successively selected. The LED situated below each function is lit in order to indicate the selected function.

4.2.5 Chart selection

Keep the SEL button corresponding to the group [5] pressed until the LED situated below the PAT indication is lit. The chart selected will be displayed in this position. Then turn the TUNE SELECT rotary selector [7] to move successively through the 32 charts that can be presented by the video generator.

A column in letters (see column indicator [3]) and a row in numbers (see row indicator [2]) will appear on the visual display. In order to enable pictures to be more easily selected, these have been arranged into 8 columns (all related in their performance).

- Groups A to E for color and general adjustments
- Groups F to H for the adjustment of B/W parameters

4.2.6 Channel selection

Keep the SEL button corresponding to the group [5] pressed until the LED situated below the CHANNEL indicator is lit. The selected channel will be displayed. Then turn the TUNE SELECT rotary selector [7] and the channels stored in the microprocessor will be consecutively selected. The channels appear arranged according to frequency (standard TV and cable TV channels).

The television channels are indicated by "C" and a number. For instance, TV channel 41 would be indicated as "C41". The cable TV channels, on the other hand, are specified by an "S", for example "S11". The channels implemented depend on the selected version (see list of versions in item 1.2 Specifications).

4.2.7 Frequency selection

Keep the SEL button corresponding to the group [5] pressed until the LED situated below the FREQ. MHz. indicator is lit. The selected frequency will be displayed. Then turn the TUNE SELECT rotary selector [7] and the frequency will change in steps of 50 kHz.

NOTE: When the frequency does not correspond to a channel, the information on the alphanumeric display will disappear.

4.2.8 Application of test pictures

Group A.- General analysis of the picture, combined pictures.

- A1 Monoscope 1 with possibility of insertion of logotypes
- A2 Color bars / Blue with zero luminance
- A3 Monoscope 2 / VTR (Video Test Recorder) signal to analyze the operation of videos.
- A4 Monoscope 3 with possibility of insertion of logotypes

Group B.- Color saturation control, tint control, etc.

- B1 Color bars
- B2 Horizontal color bars
- B3 Luminance/Color bars/Multiburst/DEM
Composite chart for contrast control, tint control, definition and color demodulators.
- B4 Color bars / Scale of greys
Saturation in optimal conditions for the adjustment of contrast and brightness.

Group C.- Color luminance control, R, G, B amplitude, seen on the screen.

- C1 White split 100% / VTR signal color bars
- C2 Red split color bars
- C3 Green split color bars
- C4 Blue split color bars

Group D.- Purity, noise and beam current control for R, G and B. R, G, B outputs check.

- D1 Red raster
- D2 Green raster
- D3 Blue raster
- D4 RGB

Group E.- Color demodulator control, phase and delay line.

- E1 Antipal with split-field 50% luminance
Adjustment of phase, delay line and color demodulators.
- E2 Axes and antipal
Adjustment of color demodulators.
- E3 Color bars / Multiburst
Verification of the video amplifier bandwidth.
- E4 Delay
Chrominance and luminance delay check.

Group F.- Resolution, video response and linearity control.

- F1 Scale of greys
Video amplifier linearity (correct ratio between the values of the electronic beam currents), whiteness control and adjustment, contrast and brightness control.
- F2 Multiburst
Determination of the bandwidth of the video amplifier.
- F3 Checker-board
Video amplifier low frequency response.
- F4 Window
Response to transients in the video signal, DC restoration circuit check (clamping), and delay.

Group G.- Focus control, geometry and matt supply.

- G1 100% white
Verification of the limiter circuit for the beam current, modulation adjustment on videotapes, measurements of the signal/noise ratio.
- G2 black
Clamping check, measurements of the signal/noise ratio, adjustment of the level of black.
- G3 50 Hz rectangular
Clamping circuits check.
- G4 MAT
Very High Tension source control.

Group H.

- H1 Cross and rectangle
Aspect, geometry and centrality ratio.
- H2 Framed grid
Centered adjustment of the picture and overscanning.
- H3 Grill
Static and dynamic convergence adjustment, interline check.
- H4 Points
Picture suitable for the adjustment of the focus voltage.

4.3 Function buttons which modify the composite video signal

Their effect may be observed at the outputs at which a composite video signal is present (VIDEO output [24], EURO-AV Euroconnector [36] pin 19 and Y-C **S**^{VHS} output [38], and in the RF modulated signal (RF connector [11]).

- BURST OFF [22]: press this button to suppress the burst of the composite video signal and enable the correct operation of the color killer in the receivers to be checked. In a correctly adjusted TV receiver no color appears on the screen if the burst is cancelled. Anomalous colorations may be due to high gain in the amplifiers and some deficiency is likely to have appeared at this stage.
When the SECAM system is selected, pressing this button eliminates the line identification signal.
- **••** OFF [21] (Chrominance): press this button to disable the chrominance. It enables suppression of the color subcarrier in the video signal in order to analyze the luminance of the color charts.
- CIRC. [20] (Electronic circle): press this button to activate the circle which may be inserted in any chart and is particularly useful in geometric adjustments.

NOTE: the insertion of the circle in the multiburst chart is not perfect, since this signal does not pass through circuits which would limit its bandwidth. As the circle in this chart does not provide any information of interest, it is preferable not to insert it during definition studies.

- IL OFF [19] (Interlace): press this button to suppress the interlace and enable an easier check to be made of the vertical integration system of the synchronisms separator. In convergence adjustments a non-interlaced signal seems more suitable in order to avoid flicker.

NOTE: When the SECAM system is selected, pressing this button permits the inclusion of the picture identification signal.

4.4 Function buttons which modify the sound modulation

The selection of the sound source is carried out by means of the SOUND switch [41].

The internal modulating signal is 1 kHz (L channel) and 3 kHz (R channel); if the input of an external sound signal is desired, use the LF MODULATION \ominus [40] input on the rear panel.

- \updownarrow OFF [18]: press this button to suppress the sound carrier on the RF output.
- DUAL [17]: press this button to select the dual mode. If the button is not pressed, stereo mode is selected (in PAL ZWEITON and NICAM).
- L OFF [16]: press this button to suppress the signal which modulates the main carrier (in all systems) or the selection of the digital information corresponding to the L channel (in NICAM).
- R OFF [15]: press this button to suppress the signal which modulates the second carrier (in PAL ZWEITON) or the selection of the digital information corresponding to the R channel (in NICAM).

4.5 Function buttons which operate on the Teletext and VPS signals

Only for equipment with teletext signal decoders, levels 1 and 1.5.

- TXT/VPS OFF [14]: press the button to cancel the teletext and VPS information in the composite video signal.

Only for equipment with VPS signal treatment. The information transmitted by this signal during recording corresponds to the day, month, hour and minute when the recording of the desired broadcast is to start. It also transmits the information on the country and broadcaster of the program. The minute of the starting time of recording may be modified by changing the chart selection.

- TXT/VPS PRG. [13]: when this button is pressed, the information to be transmitted through the VPS signal sets the video to pause.
- TXT/VPS START [12]: when this button is pressed, the information to be transmitted through the VPS signal sets the video to stop recording.

NOTE: when both buttons are pressed, a code of state is transmitted.

The information transmitted on each chart is specified below:

Information common to all charts:

Day: 01
Month: 01
Time: 01
Country: Germany

Information that varies in each row of charts:

	Row 1	Row 2	Row 3	Row 4
Minute	01	05	10	15

Table 2.

Information that varies in each column of charts:

	Col. A	Col. B	Col. C	Col. D	Col. E	Col. F	Col. G	Col. H
Program origin	ARD Bundesweit	ZDF Bundesweit	3rd PROG. Hessen 3 Landesweit	ARD/ZDF gem. Vorm P	ARD SAT 1 Plus	ZDF SAT 3 Sat	BRI Regional	HRI Regional
Stereo/Mono	Stereo	Mono	Dual	Stereo	Stereo	Mono	Dual	Stereo
Fit/Not fit	Fit	Fit	Fit	Not fit	Fit	Fit	Fit	Not fit

Table 3.

5 DESCRIPTION OF INPUTS AND OUTPUTS

5.1 Composite video output (BNC)

The composite video output is achieved through the VIDEO connector \ominus [24] on the front panel. The polarity of the signal is positive and the synchronisms negative, the black level being 0 V. The amplitude may be varied by means of the video level control LEVEL [23] between 0 and 1.2 Vpp. In the "CAL" position, the amplitude is normalized at 1 Vpp. This signal is very useful in testing B/W and color video monitors, linear amplifiers, VCR or any other equipment which operates with a composite video signal.

CAUTION 

This signal must not be connected to any live point in a circuit, but only to normalized video inputs of 75 Ω impedance. Any damage produced in the equipment due to non-observation of this precaution is not covered by the guarantee.

5.2 Modulated RF output

The modulated RF output (with the video and sound selected) is achieved through the RF connector \ominus [11] on the front panel.

The modulation of the RF carrier by the video signal is achieved by means of a suitably polarized diode modulator (this achieves double sideband modulation); the inversion of modulation, positive or negative, is achieved by modifying the polarity of this video signal. Given that a broadcasting station uses vestigial-sideband transmission, the correct tuning-frequency corresponds:

- If it is tuned to the TV -> to higher frequency
- If it is tuned to the generator -> to lower frequency.

Incorrect tuning can be clearly distinguished from correct tuning by the appearance of a low signal/noise ratio, inversions of modulation or lack of synchronism.

The wide frequency margin of the 1251B permits the selection of 38.9 MHz (45,75 in USA), which is the intermediate frequency used by TV receivers. It is possible to connect the modulated signal to the IF stage input and test, in case of failure, whether it occurs in the tuner or in a later stage.

The possibility of attenuating the RF output has been foreseen for testing the automatic gain control circuits and the sensitivity of television sets: one three-stage attenuator, two -20 dB (buttons [9] and [10]) and one -10 dB (button [8]) are incorporated, permitting a total maximum attenuation of -50 dB (30 μ V) in steps of -10 dB. Normally, a correctly adjusted television set shows an effect of snow in an image when 30 dB (300 μ V) attenuation is selected.

5.3 Synchronisms output

The synchronisms output is situated on the rear panel, through the SYNC. connector \ominus [30]. It serves for the synchronization of monitors with an input for separate synchronisms, the horizontal and vertical synchronisms are present.

By means of the POLARITY selector [39] its polarity (positive or negative) may be inverted in order to adapt it to the requirements of the monitor examined.

5.4 Trigger oscilloscope

The trigger output for the oscilloscope is situated on the rear panel, through the TRIG. SCOPE connector \ominus [31].

At this output horizontal synchronisms are mixed with vertical ones of a different amplitude. It enables a perfectly synchronized TV picture to be obtained on an oscilloscope, independently of the amplitudes of the observed signals and thus can be used to analyze the different circuits of a television set. This output should therefore be connected to the external synchronism input of the oscilloscope. If the oscilloscope has an automatic TV filter connected to the time base switch, it is possible to pass from the horizontal frequency to the vertical without losing the synchronism.

5.5 R-G-B outputs

The R-G-B outputs are situated on the rear panel, through three BNC sockets [32], [33] and [34], respectively.

By means of the selector SYNC.G [37] it is possible to insert synchronisms in the G output.

These signals serve for the testing of color monitors with analogous R, G, B inputs, special effects equipment, mixer desks, etc.

NOTE: these outputs cannot be used in "ANTI-PAL" chart analysis, since it is a natural characteristic of this signal that it affects the color subcarrier.

5.6 LF sound input

This is via the DIN41524 LF MODULATION socket \ominus [40] situated on the rear panel.

External audio signal inputs which may be used to modulate TV signal sound carriers.

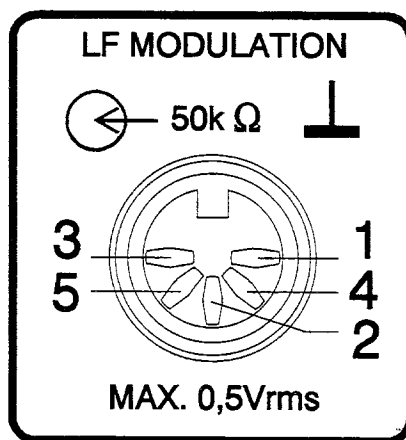

Figure 13.- LF sound input socket.

- [1] Left channel audio output (not connected)
- [2] Audio ground
- [3] Left channel audio input
- [4] Right channel audio output (not connected)
- [5] Right channel audio input

5.7 S-VHS output

This is via the 4-contact socket **S VHS** [38] on the rear panel.

Separate luminance and chrominance outputs used in the S-VHS system are available. Their use as a high quality video standard is becoming more and more widespread and the quantity of television sets and video equipment incorporating them is increasing.

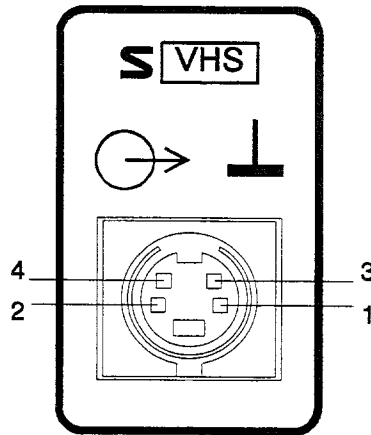

Figure 14.- S-VHS socket.

- [1] Luminance signal ground
- [2] Chrominance signal ground
- [3] Luminance signal
- [4] Chrominance signal

5.8 Euroconnector (DIN EN 50049)

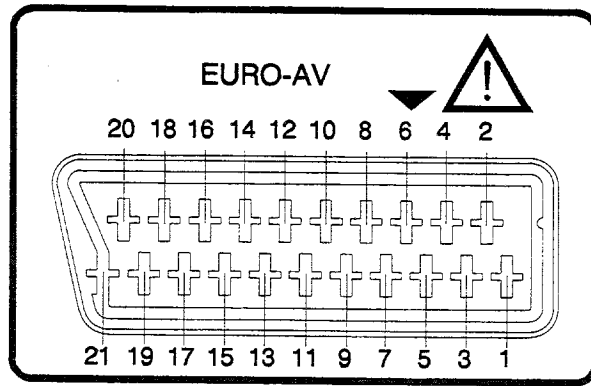

Figure 15.- Euroconnector.

Also known as SCART or PERITEL connector (according to the NF-C92250 norm). The output signals in this socket as follows:

<u>No. OF PIN</u>	<u>SIGNAL</u>	<u>CHARACTERISTICS</u>
1	Right channel audio output	
2	Right channel audio input	
3	Left channel audio output	
4	Audio ground	
5	Blue ground (B)	
6	Left channel audio input	
7	Blue output (B)	
8	Switching voltage	(not connected)
9	Green ground (G)	
10	Interface bus digital	(not connected)
11	Green output (G)	
12	Interface bus digital	(not connected)
13	Red ground (R)	
14	Reserved bus digital	(not connected)
15	Red output (R)	
16	Blanking signal	(not connected)
17	Composite video ground	
18	Blanking return	(not connected)
19	Composite video output	
20	Video input	
21	Connector shell ground	

6 PRINCIPLES OF OPERATION

6.1 Circuit description

This section deals with a general explanation of the operation of the 1251B. The items below refer to the block diagram and to the diagrams of the equipment.

a) μ C control

Controls the presentation of the display according to the user's selections (chart, channel and frequency). It is responsible for the transmission of data to the synthesized RF unit and for the storage, in a E2PROM memory, of various configurations selected by the user (up to 32 memories). In the internal EPROM, besides the control program, the tables corresponding to TV channels (standard CCIR or FCC) are stored.

b) Display

It is responsible for the alphanumeric presentation of the data transmitted by the μ C (it can present 1 row of 16 characters). In addition, it provides illumination to enable the data to be more easily seen.

c) Function buttons

There are 11 buttons situated on the lower front part. They serve to activate and deactivate the basic functions, divided into three groups: video, sound and teletext/VPS.

d) Synchronisms and logic control generator

The module which generates the basic signals of the video generator.

In accord with the selection signals of the system transmitted by the μ C is responsible for the generation of all the synchronisms signals, the color carrier and auxiliary signals employed by other modules of the equipment.

A PLL circuit is responsible for the generation of a 20 MHz signal providing the maximum resolution per line.

In accord with the chart selection signals transmitted by the μ C and internal signals, the different addresses of an EPROM, which contains the information on the data to be transmitted to the video output, are sampled.

e) Multiburst and electronic circle generator

The multiburst generator is based on charge and discharge of a capacitor by means of a constant current source. The switching between the charge and discharge is carried out in the comparator circuit and the selection of various frequencies by means of the intensity variation of the current source. After this, the triangular signal generated is shaped by means of diodes to make it almost sinusoidal.

The electronic circle generator is based on scanning the data contained in an EPROM (at 20 MHz) synchronized with the periods of the picture and line and switching depending on the standard selected.

In addition, this module contains the R, G and B signal output stages.

f) PAL/NTSC/SECAM color modulator

This is composed of a common part, which generates signals (R-Y) and (B-Y) or Dr and Db, depending on the system selected:

- PAL/NTSC modulator: the sum of the signal generated by two AM modulators.
- SECAM modulator: FM modulation of the Dr and Db signals synchronized with the line frequency.

The chrominance signal obtained is added to the luminance (delayed in SECAM). The composite video signal will be inverted or not, depending on the system selected, to be transmitted to the RF modulator input.

g) Logotype generator

Based on the scanning of the data contained in an EPROM (at 20 MHz), synchronized with the line and frame frequencies, it is also provided with auxiliary signals indicating position and contents of the logo. The VTR signal is also generated in this module.

h) Teletext and VPS generator

Based on the scanning of the data contained in an EPROM (at 5 MHz/VPS and 6.9375 MHz/teletext synchronized with the line frequency). This module is responsible for the generation of the signals which control this board (frequency switching, appearance of signals in the video signal, etc.).

i) L sound carrier generator

This module is divided into differentiated parts:

- Internal LF signal generator (Wien bridge oscillator), LF input stage (pre-emphasis filters of 50 μ s and 75 μ s), and LF signal switching.
- Sound carrier generator and FM modulator synchronized with the line frequency, programmable counter depending on the standard selected, summator of the LF signal for the modulation of FM.
- AM modulator (Secam/L)
The circuit is responsible for the multiplexing of the signal in order to obtain the correct signal at the output, depending on the standard selected.

j) R sound carrier generator (Zweiton)

This module is divided in three differentiated parts:

- Internal LF signal generator (Wien bridge oscillator), LF input stage (pre-emphasis filter of 50 μ s), and LF signal switching.
- Sound carrier 2 generator, FM modulator, summator of the LF signal for the modulation of FM.
- Generator of the identification carrier and pilot frequencies (117 Hz and 234 Hz) identifying the stereo/dual mode, modulated in AM.

k) NICAM sound generator

This is composed of:

- The data of the coded LF signal are stored in an EPROM, which is sampled at a frequency 8 times greater than the data transmission frequency (5.824 MHz). The output signals are digitally filtered (at 40% cosine roll-off in B/G and at 100% in I) and pass through a D/A converter. After being filtered they will become the LF inputs of the modulators.
- Oscillators which generate the carrier frequencies needed for the two standards (B/G and I) of 5.85 MHz and 6.552 MHz are 90° out of phase and go to the inputs of the modulators. The outputs of the modulators are summed and will form the signal to be transmitted.

l) RF modulator

The radio-frequency signal is AM modulated by the video signal through a diode modulator. These diodes are suitably polarized in order to achieve the best possible modulation over the wide range of frequencies covered by the generator. The carrier frequency is generated by voltage controlled oscillators (varicaps). The oscillator selection is carried out, as the control voltage in tuning, by a PLL thus achieving a synthesized output frequency.

m) Main board

The base board is responsible for the interconnection of all the boards, and in addition, for the generation of all the necessary voltages (+5 V, -5 V, +12 V, +33 V). The keyboard and the majority of output connectors are also placed here.

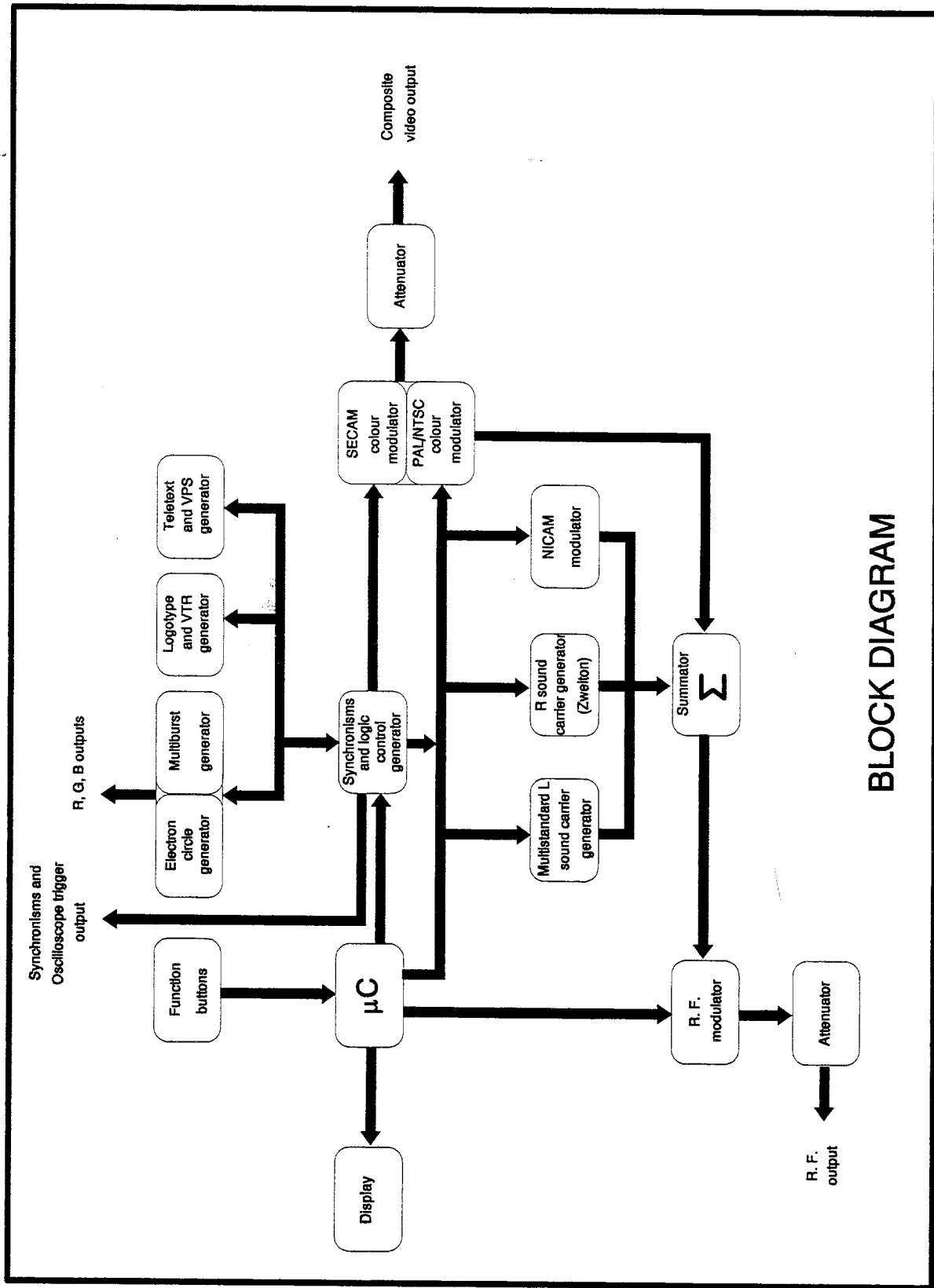

BLOCK DIAGRAM

7 MAINTENANCE

7.1 Replacing the mains fuse

The fuseholder lid is placed in the mains base (see figure 1) and it is the voltage selector.

To substitute the fuse, disconnect the power cord.

With an appropriate screw driver remove the fuseholder lid.

Substitute the melt fuse for another of: **0.5 A F, for 220, 230 and 240 V**
1 A F, for 110 and 125 V

When inserting the fuseholder lid be careful that the voltage selector is in the correct position according to the mains.

7.2 Cleaning recommendations

CAUTION

To clean the cover, be sure the instrument is disconnected.

CAUTION

Do not use scented hydrocarbons or chlorized solvents. Such products may attack the plastics used in the construction of the cover.

The cover should be cleaned by means of a light solution of detergent and water applied with a soft cloth.

Dry thoroughly before using the system again.



Limited One-Year Warranty

B&K Precision Corp. warrants to the original purchaser that its product and the component parts thereof, will be free from defects in workmanship and materials for a period of one year from the date of purchase.

B&K Precision Corp. will, without charge, repair or replace, at its' option, defective product or component parts. Returned product must be accompanied by proof of the purchase date in the form a sales receipt.

To obtain warranty coverage in the U.S.A., this product must be registered by completing and mailing the enclosed warranty card to B&K Precision Corp., 1031 Segovia Circle, Placentia, CA 92870 within fifteen (15) days from proof of purchase.

Exclusions: This warranty does not apply in the event of misuse or abuse of the product or as a result of unauthorized alternations or repairs. It is void if the serial number is alternated, defaced or removed.

B&K Precision Corp. shall not be liable for any consequential damages, including without limitation damages resulting from loss of use. Some states do not allow limitation of incidental or consequential damages, so the above limitation or exclusion may not apply to you.

This warranty gives you specific rights and you may have other rights, which vary from state-to-state.

Model Number: _____

Date Purchased: _____

1031 Segovia Circle
Placentia, CA 92870
714.237.9220
714.237.9214 Facsimile



Service Information

Warranty Service: Please return the product in the original packaging with proof of purchase to the below address. Clearly state in writing the performance problem and return any leads, connectors and accessories that you are using with the device.

Non-Warranty Service: Return the product in the original packaging to the below address. Clearly state in writing the performance problem and return any leads, connectors and accessories that you are using with the device. Customers not on open account must include payment in the form of a money order or credit card. For the most current repair charges contact the factory before shipping the product.

Return all merchandise to B&K Precision Corp. with pre-paid shipping. The flat-rate repair charge includes return shipping to locations in North America. For overnight shipments and non-North America shipping fees contact B&K Precision Corp..

B&K Precision Corp.
1031 Segovia Circle
Placentia, CA 92870
Phone: 714- 237-9220
Facsimile: 714-237-9214
Email: service@bkprecision.com
Website: www.bkprecision.com

Include with the instrument your complete return shipping address, contact name, phone number and description of problem.

BK PRECISION®

PN: 480-843-9-001
Printed in Spain
©2000 B&K Precision Corp.

(0 M10779)

1031 Segovia Circle
Placentia, CA 92870-7137 USA
TEL: 714-237-9220
FAX: 714-237-9214
www.bkprecision.com